



# SS22 THRU SS2200

Reverse Voltage - 20 to 200 Volts Forward Current - 2.0 Ampere

## SURFACE MOUNT SCHOTTKY BARRIER RECTIFIER

### Features

- ◆ The plastic package carries Underwriters Laboratory Flammability Classification 94V-0
- ◆ For surface mounted applications
- ◆ Metal silicon junction, majority carrier conduction
- ◆ Low power loss, high efficiency
- ◆ Built-in strain relief, ideal for automated placement
- ◆ High forward surge current capability
- ◆ High temperature soldering guaranteed:  
250 °C/10 seconds at terminals

DO-214AC/SMA

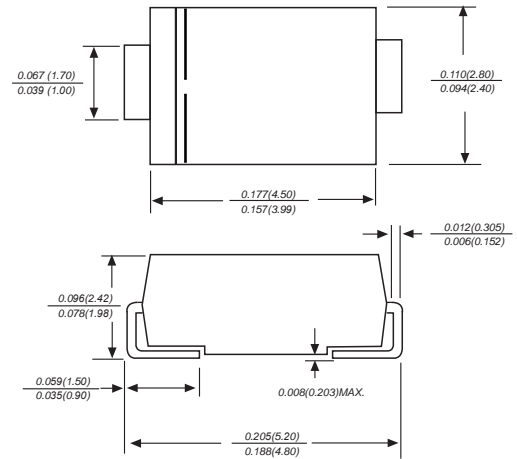

Dimensions in inches and (millimeters)

### Mechanical Data

Case: JEDEC DO-214AC/SMA molded plastic body  
 Terminals: Solderable per MIL-STD-750, Method 2026  
 Polarity: Color band denotes cathode end Mounting  
 Position: Any  
 Weight: 0.0021ounce, 0.06grams

### Maximum Ratings And Electrical Characteristics

Ratings at 25°C ambient temperature unless otherwise specified.

Single phase half-wave 60Hz, resistive or inductive load, for capacitive load current derate by 20%.

Parameter	SYMBOLS	MDD SS22	MDD SS23	MDD SS24	MDD SS25	MDD SS26	MDD SS28	MDD SS210	MDD SS2150	MDD SS2200	UNITS
Marking Code											
Maximum repetitive peak reverse voltage	$V_{RMM}$	20	30	40	50	60	80	100	150	200	V
Maximum RMS voltage	$V_{RMS}$	14	21	28	35	42	56	70	105	140	V
Maximum DC blocking voltage	$V_{DC}$	20	30	40	50	60	80	100	150	200	V
Maximum average forward rectified current	$I_{AV}$	2.0									A
Peak forward surge current 8.3ms single half sine-wave superimposed on rated load (JEDEC Method)	$I_{FSM}$	50									A
Maximum instantaneous forward voltage at 2.0A	$V_F$	0.55			0.70		0.85		0.95		V
Maximum DC reverse current at rated DC blocking voltage $T_A=25^\circ\text{C}$ $T_A=100^\circ\text{C}$	$I_R$	0.5					0.3				mA
		5					3				
Typical junction capacitance (NOTE 1)	$C_J$	220			80						pF
Typical thermal resistance (NOTE 2)	$R_{\theta JA}$	80.0									$^\circ\text{C}/\text{W}$
Operating junction temperature range	$T_J$	-55 to +125					-55 to +150				$^\circ\text{C}$
Storage temperature range	$T_{STG}$	-55 to +150									$^\circ\text{C}$

Note: 1. Measured at 1MHz and applied reverse voltage of 4.0V D.C.  
 2. P.C.B. mounted with 2.0"x2.0" (5.0x5.0cm) copper pad areas



# SS22 THRU SS2200

Reverse Voltage - 20 to 200 Volts Forward Current - 2.0 Ampere

## Typical Characteristics

Fig.1 Forward Current Derating Curve

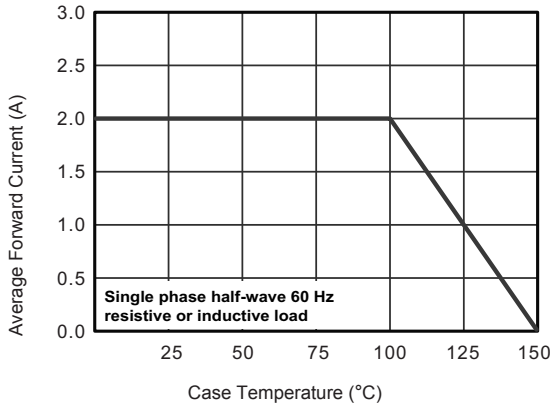

Fig.2 Typical Reverse Characteristics

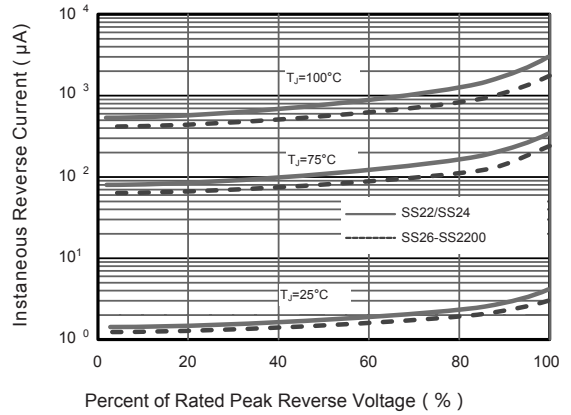

Fig.3 Typical Forward Characteristic

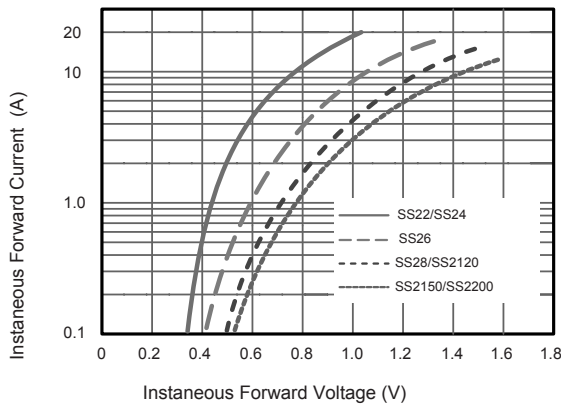

Fig.4 Typical Junction Capacitance

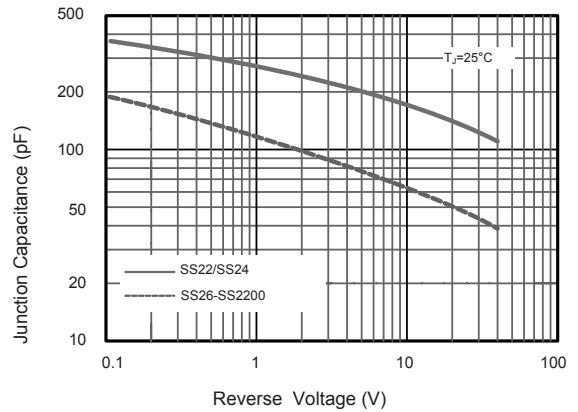

Fig.5 Maximum Non-Repetitive Peak Forward Surge Current

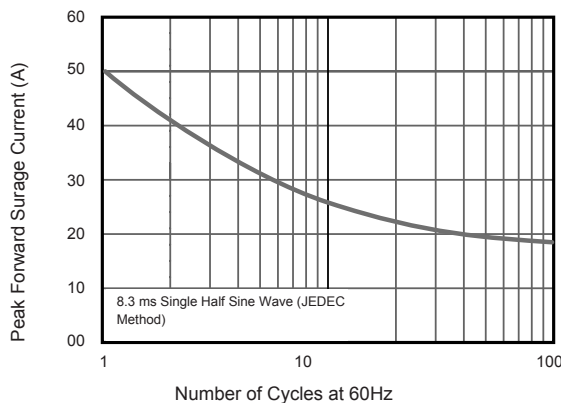
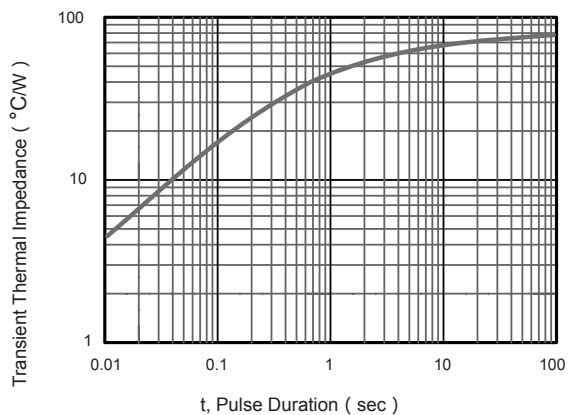

Fig.6 Typical Transient Thermal Impedance



The curve above is for reference only.



# SS22 THRU SS2200

Reverse Voltage - 20 to 200 Volts Forward Current - 2.0 Ampere

## Packing information

unit:mm

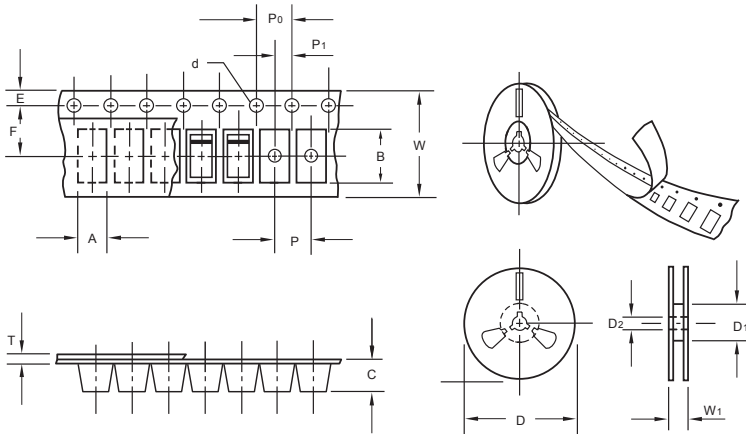

Item	Symbol	Tolerance	SMA
Carrier width	A	0.1	2.80
Carrier length	B	0.1	5.33
Carrier depth	C	0.1	2.36
Sprocket hole	d	0.05	1.50
13" Reel outside diameter	D	2.0	330.00
13" Reel inner diameter	D1	min	50.00
7" Reel outside diameter	D	2.0	178.00
7" Reel inner diameter	D1	min	62.00
Feed hole diameter	D2	0.5	13.00
Sprocket hole position	E	0.1	1.75
Punch hole position	F	0.1	5.50
Punch hole pitch	P	0.1	4.00
Sprocket hole pitch	P0	0.1	4.00
Embossment center	P1	0.1	2.00
Overall tape thickness	T	0.1	0.28
Tape width	W	0.3	12.00
Reel width	W1	1.0	18.00

Note: Devices are packed in accordance with EIA standard RS-481-A and specifications listed above.

## Reel packing

PACKAGE	REEL SIZE	REEL (pcs)	COMPONENT SPACING (m/m)	BOX (pcs)	INNER BOX (m/m)	REEL DIA, (m/m)	CARTON SIZE (m/m)	CARTON (pcs)	APPROX. GROSS WEIGHT (kg)
SMA	7"	2,000	4.0	4,000	183*155*183	178	382*356*392	80,000	16.0
SMA	11"	5,000	4.0	10,000	290*290*38	330	310*310*360	80,000	11.0
SMA	13"	7,500	4.0	15,000	335*335*38	330	350*330*360	120,000	14.5

## Suggested Pad Layout



Symbol	Unit (mm)	Unit (inch)
A	1.68	0.066
B	1.52	0.060
C	3.90	0.154
D	2.41	0.095
E	5.45	0.215