



Alpha 4A

GPS Antenna



Key Features

- Adhesive or magnetic mountable
- 26db LNA gain
- Waterproof
- Compact size

General Description

The Alpha 4A is a compact, self adhesive, waterproof, GPS antenna.

It comes with a strong self-adhesive base that provides a firm fix to most flat surfaces. The antenna is well suited to outdoor environments that GPS applications are often subject to.

The built in Low Noise Amplifier (LNA) provides a 26dB gain for superior GPS performance; necessary for strong signal reception from visible satellites as well as influencing a shorter time for satellite fixing.

Additional Considerations

- Waterproof design which makes it ideal for mounting outdoors
- Operates with GPS receivers with built in LNA circuit on board





Alpha 4A

GPS Antenna

Dielectric Antenna

Centre Frequency:	1575.42+1 MHz
Polarization:	RHCP
Impedance:	50 Ohm
VSWR:	<1.5
Axial Ratio:	3 dB Max

Mechanical Specifications

Dimensions:	L38 x W34 x H13 mm
Cable:	RG174
Connector:	SMA Male
Material:	ABS
Mounting method:	Magnetic

GPS Antenna

LNA Gain:	26 dB +/-2 dB
Noise Figure:	<1.3
VSWR:	<2.0
Filter Insertion Loss:	<3 dB
Supply Voltage:	2.5 - 5 V DC
Current Consumption:	10 - 26 mA

Environmental Specifications

Operating Temperature:	-40 to +85 °C
Relative Humidity:	Up to 95 %

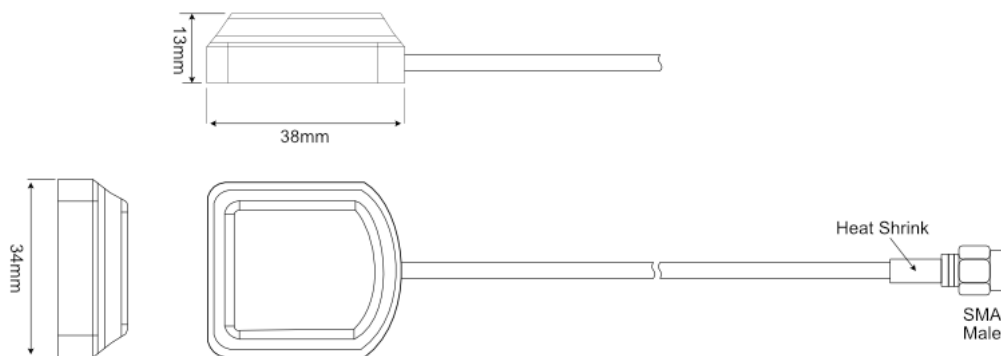



Return Loss

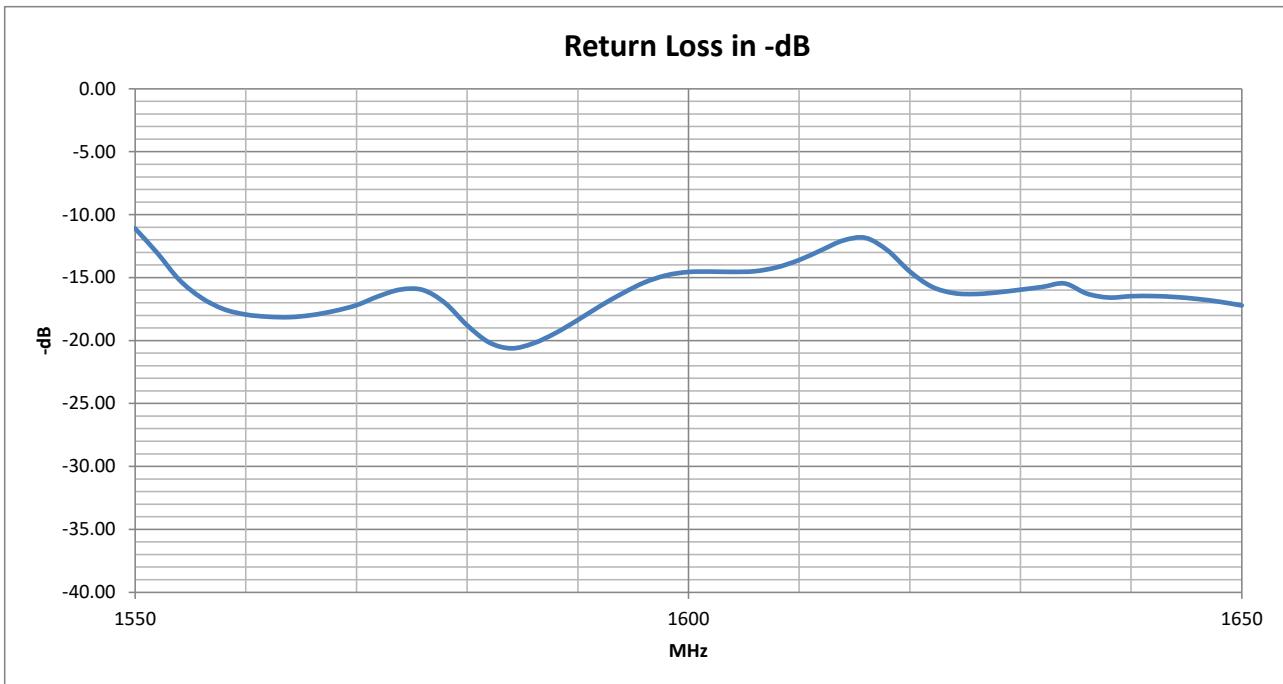

VSWR

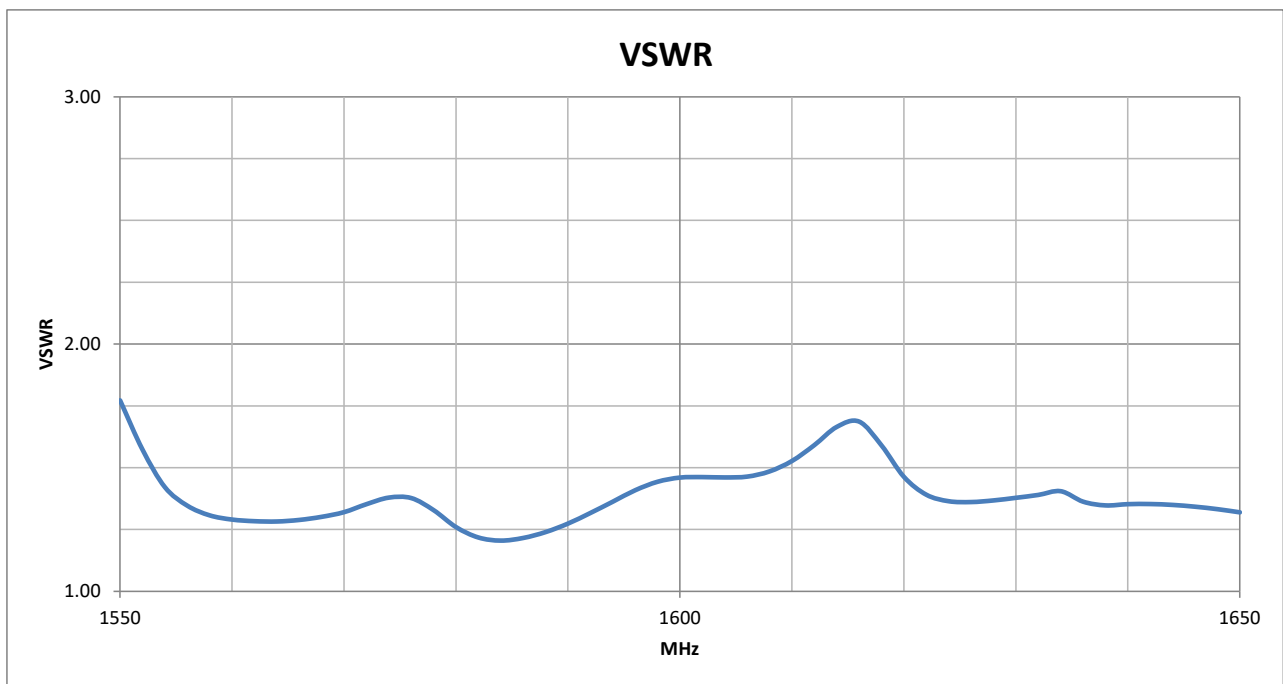



Gain

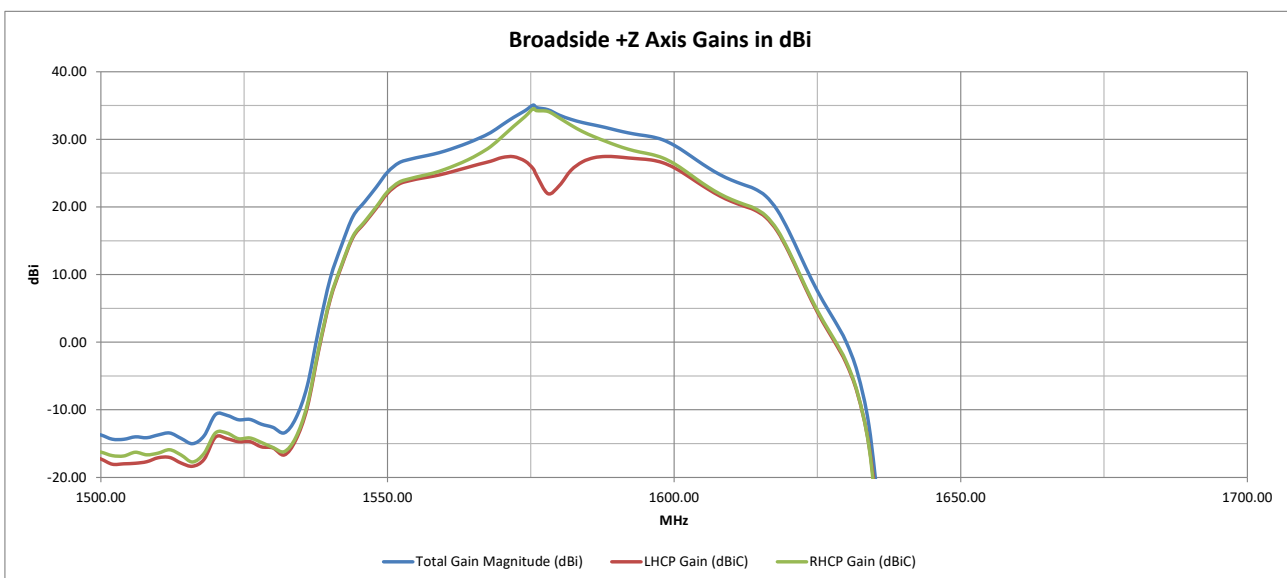
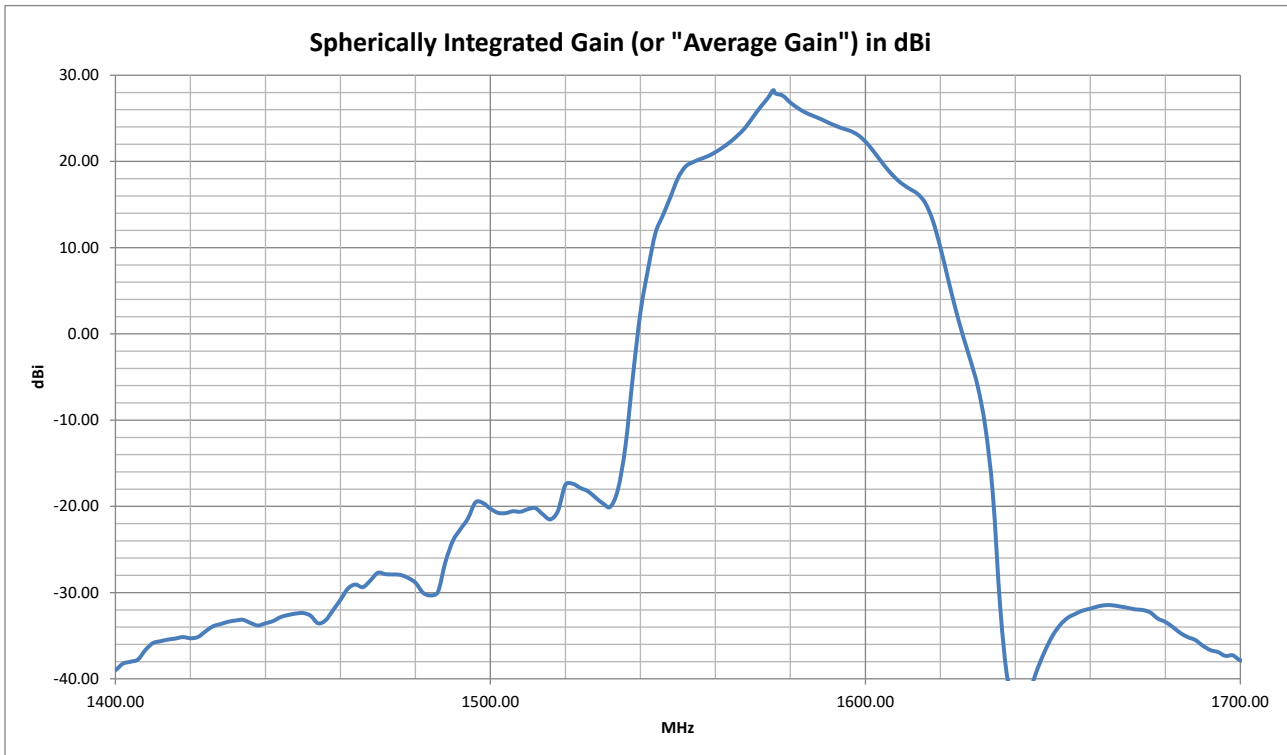



Alpha 4A

GPS Antenna

Radiation Plots tested with 1 m cable

1560 MHz XY

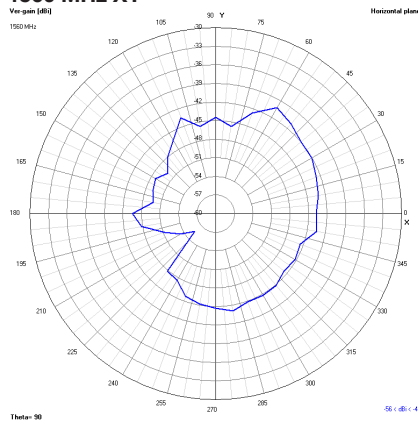

XZ

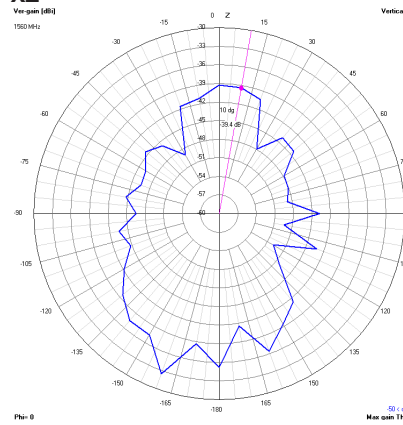

YZ

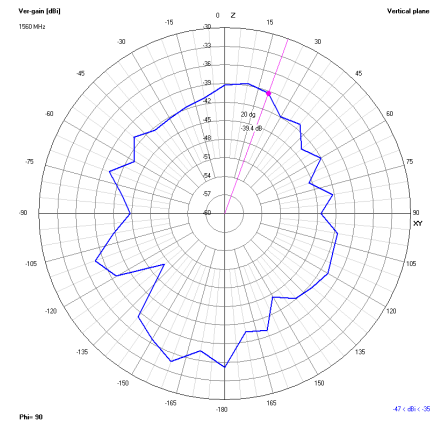

1580 MHz XY

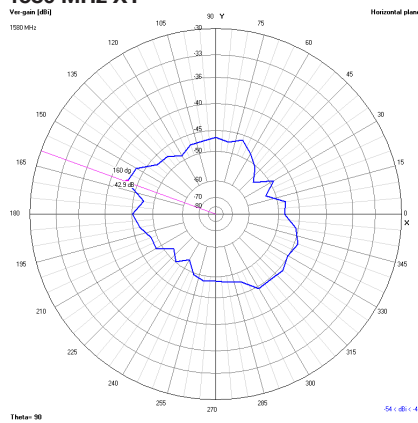

XZ

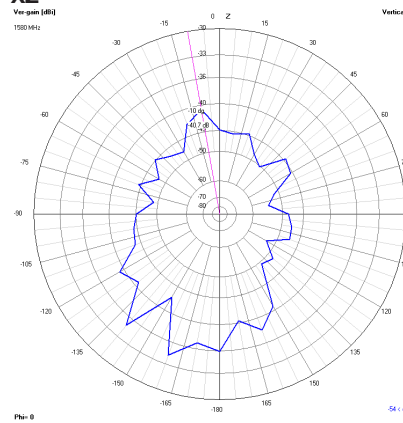

YZ

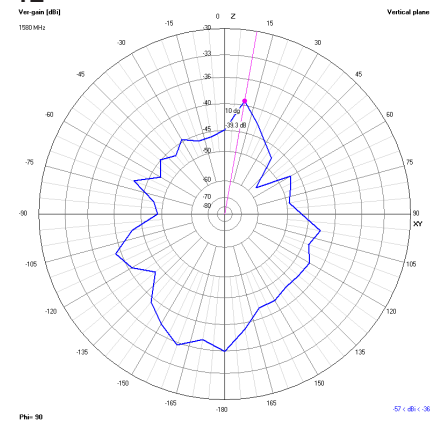



3D Radiation Plots tested with 1 m cable

1560 MHz

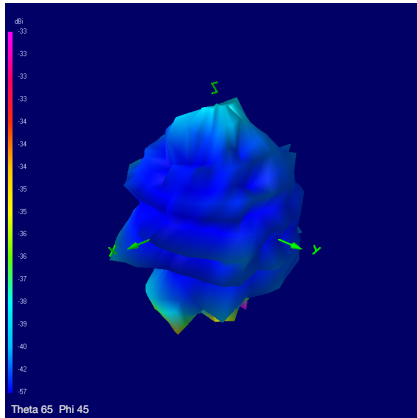

1580 MHz

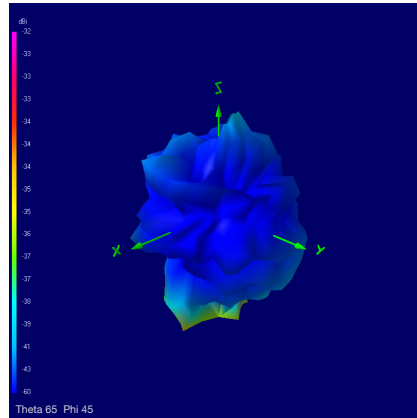

Ordering Details

Part number	Description
ALPHA4A/1M/SMAM/S/S/26	GPS ADHESIVE MOUNT ANTENNA SMA MALE CONNECTOR 1M CABLE
ALPHA4A/5M/SMAM/S/S/26	GPS ADHESIVE MOUNT ANTENNA SMA MALE CONNECTOR 5M CABLE

Registered in England No. 08405712
VAT Registration No. GB163 04 0349



Siretta Ltd
Basingstoke Road
Spencers Wood
Reading
Berkshire RG7 1PW

sales
email
web

+44(0)118 976 9000
sales@siretta.com
www.siretta.com