

Part Number: KPT-3216SGC

Super Bright Green

### Features

- 3.2mmx1.6mm SMT LED, 0.75mm thickness.
- Low power consumption.
- Wide viewing angle.
- Ideal for backlight and indicator.
- Various colors and lens types available.
- Package : 2000pcs / reel.
- Moisture sensitivity level : level 3.
- RoHS compliant.

### Description

The Super Bright Green source color devices are made with Gallium Phosphide Green Light Emitting Diode.

### Package Dimensions

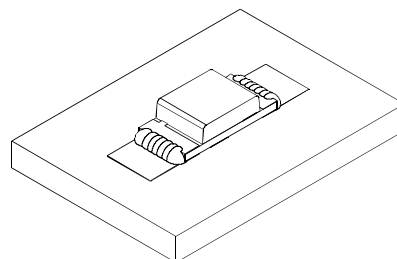
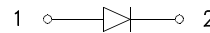
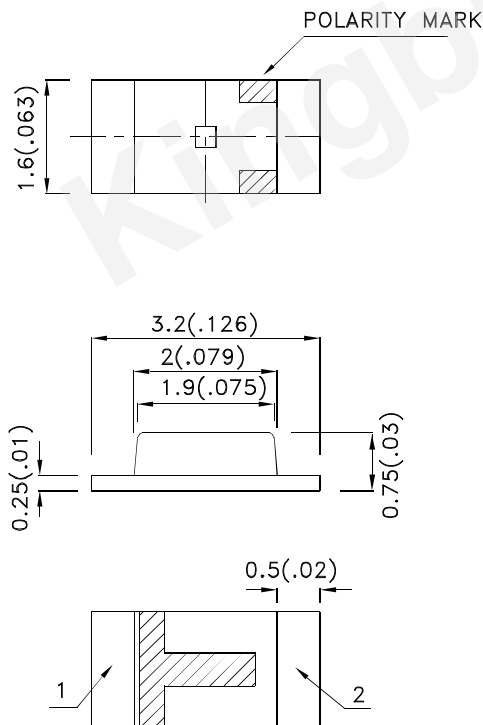

#### Notes:

1. All dimensions are in millimeters (inches).
2. Tolerance is  $\pm 0.2(0.008)$  unless otherwise noted.
3. The specifications, characteristics and technical data described in the datasheet are subject to change without prior notice.
4. The device has a single mounting surface. The device must be mounted according to the specifications.



## Selection Guide

| Part No.    | Dice                     | Lens Type   | Iv (mcd) [2]<br>@ 20mA |      | Viewing<br>Angle [1] |
|-------------|--------------------------|-------------|------------------------|------|----------------------|
|             |                          |             | Min.                   | Typ. | 2θ1/2                |
| KPT-3216SGC | Super Bright Green (GaP) | Water Clear | 5                      | 12   | 120°                 |

Notes:

1. θ1/2 is the angle from optical centerline where the luminous intensity is 1/2 of the optical peak value.
2. Luminous intensity/ Luminous Flux: +/-15%.
3. Luminous intensity value is traceable to the CIE127-2007 compliant national standards.

## Electrical / Optical Characteristics at TA=25°C

| Symbol                | Parameter                | Device             | Typ. | Max. | Units | Test Conditions           |
|-----------------------|--------------------------|--------------------|------|------|-------|---------------------------|
| $\lambda_{peak}$      | Peak Wavelength          | Super Bright Green | 565  |      | nm    | I <sub>F</sub> =20mA      |
| $\lambda_D$ [1]       | Dominant Wavelength      | Super Bright Green | 568  |      | nm    | I <sub>F</sub> =20mA      |
| $\Delta\lambda_{1/2}$ | Spectral Line Half-width | Super Bright Green | 30   |      | nm    | I <sub>F</sub> =20mA      |
| C                     | Capacitance              | Super Bright Green | 15   |      | pF    | V <sub>F</sub> =0V;f=1MHz |
| V <sub>F</sub> [2]    | Forward Voltage          | Super Bright Green | 2.2  | 2.5  | V     | I <sub>F</sub> =20mA      |
| I <sub>R</sub>        | Reverse Current          | Super Bright Green |      | 10   | uA    | V <sub>R</sub> =5V        |

Notes:

- 1.Wavelength: +/-1nm.
- 2.Forward Voltage: +/-0.1V.
- 3.Wavelength value is traceable to the CIE127-2007 compliant national standards.

## Absolute Maximum Ratings at TA=25°C

| Parameter                | Super Bright Green | Units |
|--------------------------|--------------------|-------|
| Power dissipation        | 62.5               | mW    |
| DC Forward Current       | 25                 | mA    |
| Peak Forward Current [1] | 140                | mA    |
| Reverse Voltage          | 5                  | V     |
| Operating Temperature    | -40°C To +85°C     |       |
| Storage Temperature      | -40°C To +85°C     |       |

Note:

1. 1/10 Duty Cycle, 0.1ms Pulse Width.

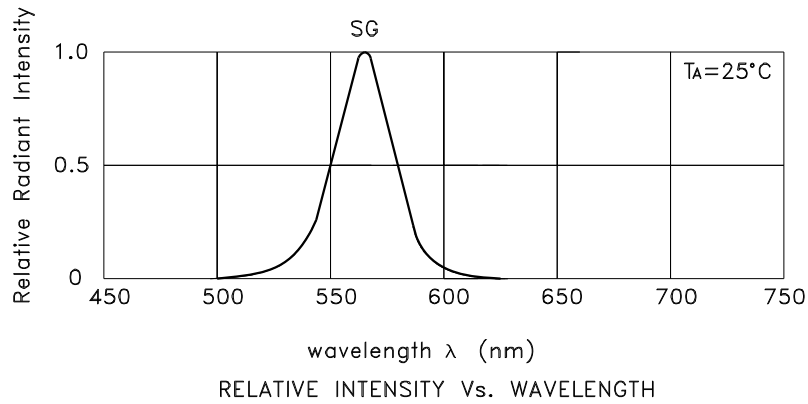

## Super Bright Green KPT-3216SGC

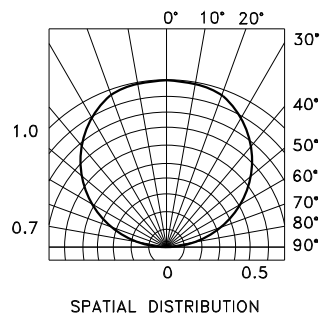
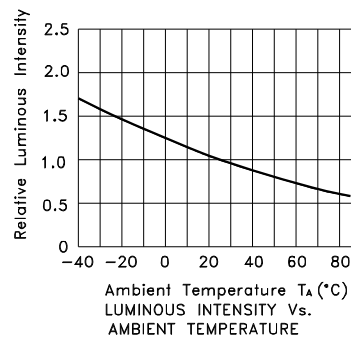
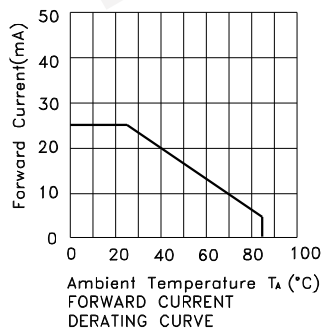
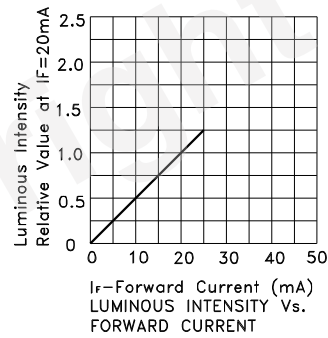
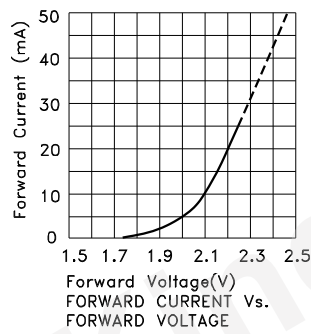

## KPT-3216SGC

Reflow soldering is recommended and the soldering profile is shown below.  
Other soldering methods are not recommended as they might cause damage to the product.

Reflow Soldering Profile For Lead-free SMT Process.

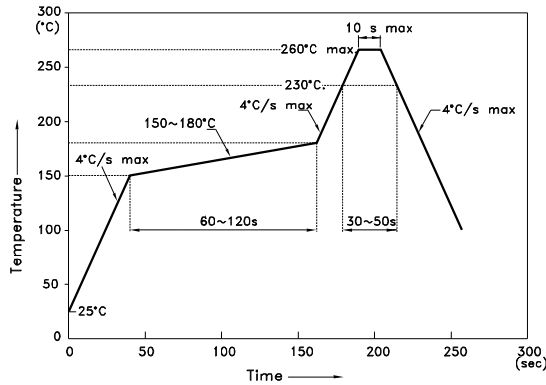

NOTES:

1. We recommend the reflow temperature 245°C(+/-5°C). The maximum soldering temperature should be limited to 260°C.
2. Don't cause stress to the epoxy resin while it is exposed to high temperature.
3. Number of reflow process shall be 2 times or less.

### Recommended Soldering Pattern (Units : mm; Tolerance: ± 0.1)

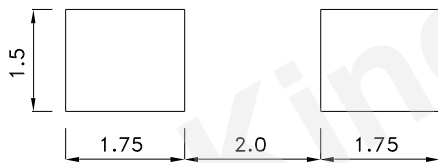

### Reel Dimension

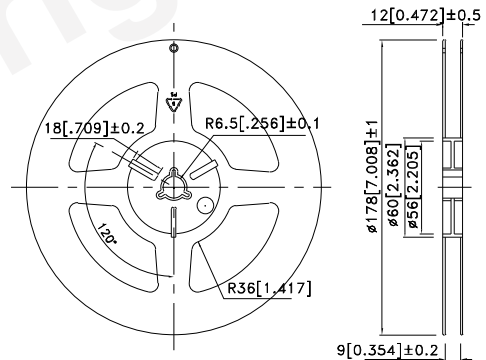

### Tape Dimensions (Units : mm)

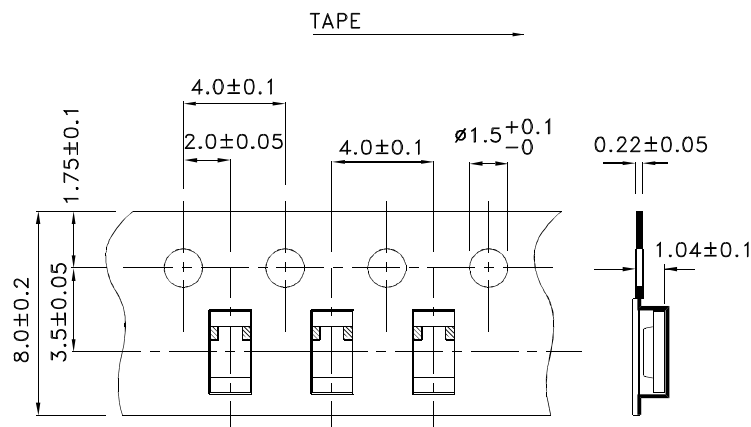

# Kingbright

## PACKING & LABEL SPECIFICATIONS

## KPT-3216SGC

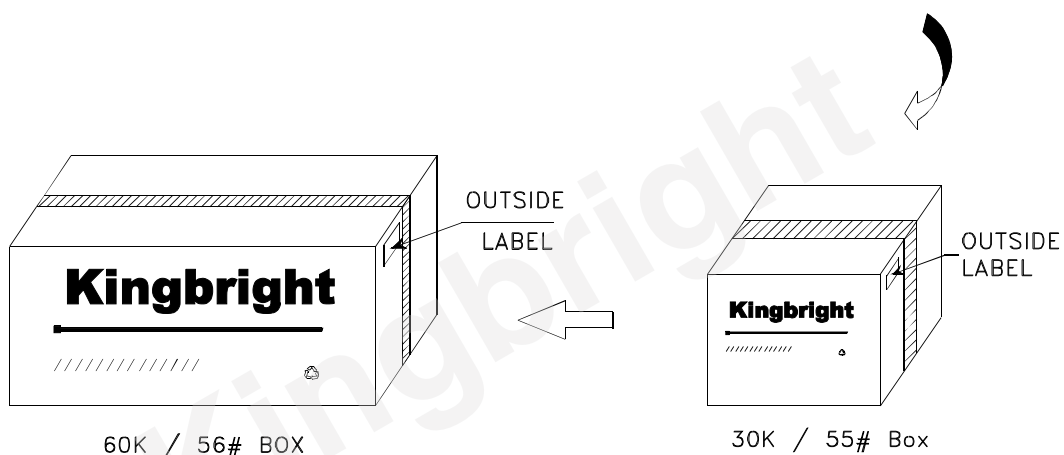
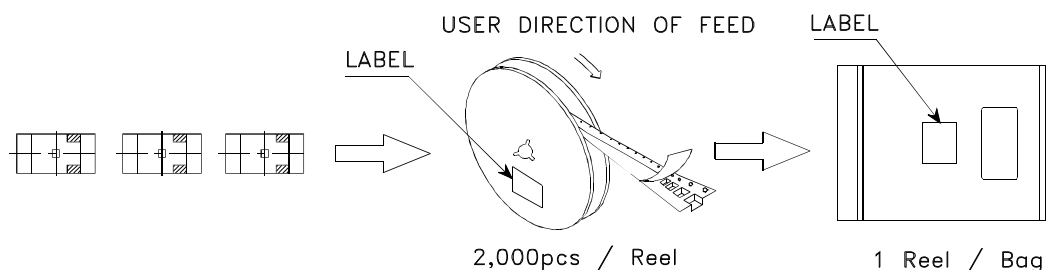

|  |  |
|--|--|
| <h1>Kingbright</h1>  |  |
| P/NO: KPT-3216xxx  |  |
| QTY: 2,000 pcs   | Q.C. <span style="border: 1px solid black; border-radius: 50%; padding: 2px;">Q C<br/>XX XX XXXX<br/>PASSED</span> |
| S/N: XXXX  |  |
| CODE: XXX  |  |
| LOT NO:  |  |
| <br>XXXXXXXXXXXXXXXXXXXXXXXXXXXX |  |
| RoHS Compliant   |  |