

AMRI SERIES

AC - DC DIN RAIL MOUNTABLE POWER SUPPLY
INDUSTRIAL CONTROL EQUIPMENT



FEATURES

- UNIVERSAL INPUT 90~264VAC
- SHORT CIRCUIT PROTECTION
- INTERNAL INPUT FILTER
- LOW PROFILE FOR BUILDING AUTOMATION
- 3 YEARS WARRANTY



MODEL LIST

MODEL NO.	INPUT VOLTAGE	OUTPUT WATTAGE	OUTPUT VOLTAGE	OUTPUT CURRENT	EFF. (min.)	EFF. (typ.)
Single Output Models						
AMRI-05	90~264 VAC	7.5 WATTS	+ 5 VDC	1500 mA	73%	75%
AMRI-12	90~264 VAC	10 WATTS	+ 12 VDC	830 mA	77%	79%
AMRI-15	90~264 VAC	10 WATTS	+ 15 VDC	670 mA	78%	80%
AMRI-24	90~264 VAC	10 WATTS	+ 24 VDC	420 mA	78%	80%

SPECIFICATION

All Specifications Typical At Nominal Line, Full Load, 25°C Unless Otherwise Noticed

GENERAL						
Characteristics	Conditions	min.	typ.	max.	unit	
Switching frequency	Vi nom, Io nom		132		KHz	
Isolation voltage	Input-Output	3,000/4,242			VAC / VDC	
Isolation resistance	Input-Output, @ 500VDC	100			MΩ	
Ambient temperature	Operating at Vi nom	-40		+ 71	°C	
Derating (see derating curve)	Vi nom, from +61°C to +71°C			2.5	% / °C	
Storage temperature	Non operational	-40		+ 85	°C	
Relative humidity	Vi nom, Io nom	20		95	% RH	
Temperature coefficient	Vi nom, Io min			± 0.03	% / °C	
MTBF	Bellcore Issue 6 @40°C, GB	5V		901,000	Hours	
		12V		888,000	Hours	
		15V		893,000	Hours	
		24V		910,000	Hours	
Altitude during operation	IEC 60068-2-13			4,850	m	
Dimension		L91 x W18 x D56.5			mm	
Cooling	Free air convection					
Installation position	Vertical (other direction may derating using)					
Pollution degree		2				

SPECIFICATION

All Specifications Typical At Nominal Line, Full Load, 25°C Unless Otherwise Noticed

INPUT SPECIFICATIONS

Characteristics	Conditions	min.	typ.	max.	unit
Rated input voltage	Io nom	100		240	VAC
Absolute input max. range	Ta min ... Ta max, Io nom	AC in	90	264	VAC
		DC in	120	375	VDC
Input current	Vi : 115 / 230 VAC, Io nom		200 / 135		mA
Rated input current	Vi : 90 VAC, Io nom			300	mA
Line frequency	Vi nom, Io nom	47		63	Hz
Inrush current	Vi : 115 / 230 VAC, Io nom			16 / 32	A
Power dissipation	Vi : 230 VAC, Io nom	5V	2.5		W
		12V	2.7		W
		15V	2.5		W
		24V	2.5		W
Leakage current	Input-Output			0.25	mA

OUTPUT SPECIFICATIONS

Characteristics	Conditions	min.	typ.	max.	unit
Output voltage accuracy (Adjusted before shipment)	Vi nom, Io max			± 1	%
Minimum load	Vi nom	0			%
Line regulation	Io nom, Vi min ... Vi max			± 1	%
Load regulation	Vi nom, Io min ... Io nom			± 1	%
Hold up time	Vi : 115 / 230 VAC, Io nom	10 / 30			ms
Turn on time	Vi nom, Io nom			1,000	ms
	Vi nom, Io nom → Capacitor load			1,500	ms
Rise time	Vi nom, Io nom			150	ms
	Vi nom, Io nom → Capacitor load			500	ms
Fall time	Vi nom, Io nom			150	ms
Transient recovery time	Vi nom, I ~ 0.5 Io nom			2	ms
Ripple & noise	Vi nom, Io nom, BW = 20MHz			50	mV
Power back immunity	Vi nom, Io nom	5V	7.5		VDC
		12V	18		VDC
		15V	22		VDC
		24V	35		VDC
Capacitor load	Vi nom, Io nom	5V		3,500	μF
		12V		1,800	μF
		15V		1,500	μF
		24V		560	μF
DC ON indicator threshold at start up (Green LED)	Vi nom, Io nom	5V	3.5	4.5	VDC
		12V	9	10.8	VDC
		15V	11	13.5	VDC
		24V	19.2	21.6	VDC
DC LOW indicator threshold after start up (Red LED)	Vi nom, Io nom	5V	3.5	4.5	VDC
		12V	9	10.8	VDC
		15V	11	13.5	VDC
		24V	19.2	21.6	VDC
Efficiency	Vi nom, Io nom, Po / Pi			Up to 80%, See model list and typ efficiency curve	

CONTROL AND PROTECTION

Characteristics	Conditions	min.	typ.	max.	unit
Input fuse			T1A / 250VAC internal		
Internal surge voltage protection	IEC 61000-4-5		Varistor		
Rated over load protection	Vi nom (see typ current limited curve)	125		185	%
Over voltage protection	Vi nom, Io nom (Auto Recovery)	5V	5.75	6.5	VDC
		12V	15	16.5	VDC
		15V	18	20	VDC
		24V	30	33	VDC
Output short circuit			Hiccup mode		
Degree of protection			IP20		

SPECIFICATION

All Specifications Typical At Nominal Line, Full Load, 25°C Unless Otherwise Noticed

APPROVALS AND STANDARDS

UL / cUL	UL 508 Listed UL 60950-1, UL 1310 Class 2 Power Recognized ISA 12.12.01(Class I, Division 2, Groups A, B, C and D)
TUV	EN 60950-1
CE	EN 61000-6-3, EN 55022 Class B, EN 61000-3-2, EN 61000-3-3 EN 61000-6-2, EN 55024, EN 61000-4-2 Level 3, EN 61000-4-3 Level 3 EN 61000-4-4 Level 4, EN 61000-4-5 L-N Level 3 EN 61000-4-6 Level 3, EN 61000-4-8 Level 4, EN 61000-4-11 ENV 50204 Level 2, EN 61204-3
Vibration resistance	meet IEC 60068-2-6 (Mounting on rail : 10-500 Hz, 2G, along X, Y, Z each Axis, 60 min for each Axis)
Shock resistance	meet IEC 60068-2-27 (15G, 11ms, 3 Axis, 6 Faces, 3 times for each Face)

PHYSICAL CHARACTERISTICS

Case size	91 x 18 x 56.5 mm (3.58 x 0.71 x 2.22 inches)
Case material	Plastic
Weight	65g
Packing	0.11kg ; 120pcs / 14.5kg / 2.28CUFT

MECHANISM & PIN CONFIGURATION

mm [inch]

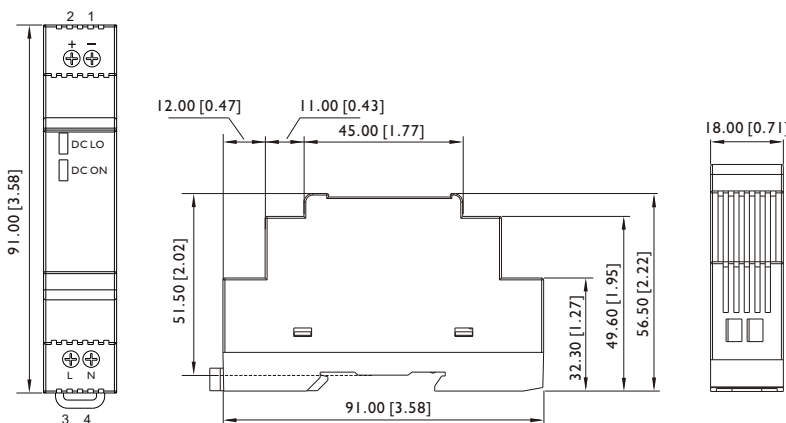

CONSTRUCTION

Easy snap-on mounting onto the DIN-Rail (TS35/7.5 or TS35/15), unit sits safely and firmly on the rail; no tools required even to remove

INSTALLATION

Ventilation / Cooling
Normal convection
All sides 25mm free space
For cooling recommended
Connector size range
AWG26-12 (0.2~2.5mm²) flexible / solid cable
-Connector can withstand torque at maximum 5 pound-inches.
4~5mm stripping at cable end recommends.
Use copper conductors only, 60/75 °C

GENERAL TOLERANCE

0.00[0.00] - 30.00[1.18]	±0.30[0.01]
30.00[1.18] - 120.00[4.72]	±0.50[0.02]

PIN ASSIGNMENT

PIN NO	Designation	Description
1	OUT	- Negative output terminal
2		+ Positive output terminal
3	IN	L Input terminals (phase conductor, no polarity at DC input)
4		N Input terminals (neutral conductor, no polarity at DC input)
	OTHER	DC ON Operation indicator LED
		DC LO DC Low indicator LED

CIRCUIT SCHEMATIC

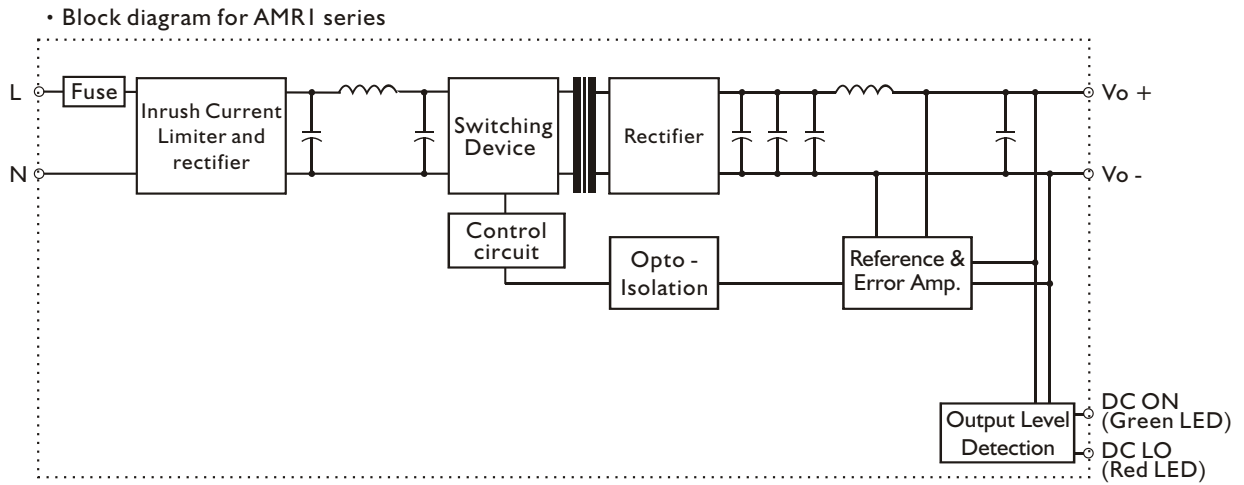

TYP. CURRENT LIMITED CURVE

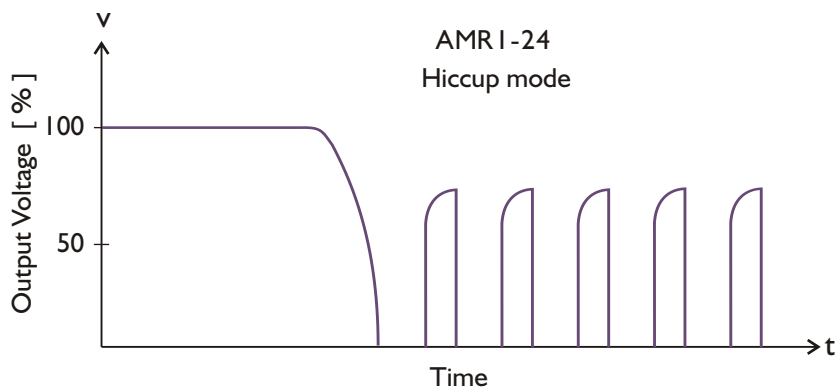

DERATING CURVE

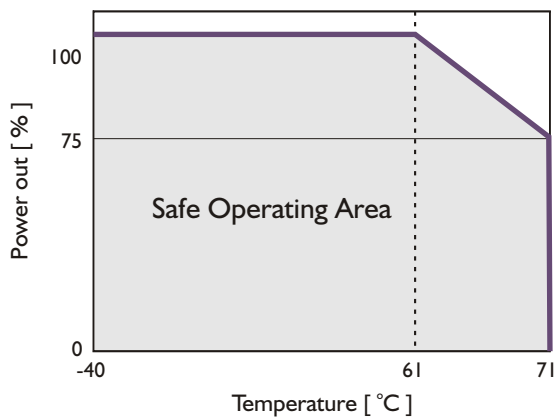

TYP. EFFICIENCY CURVE

