

# Cree® PLCC6 3 in 1 SMD LED CLX6F-FKC

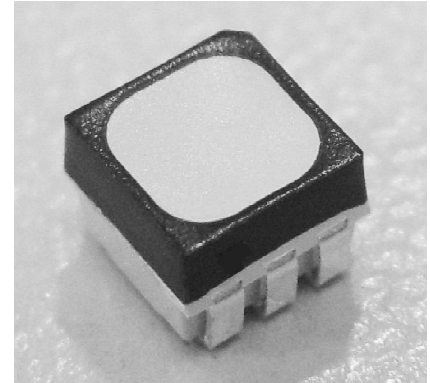

## PRODUCT DESCRIPTION

This SMD LED features an IPX8 water resistant rating in a PLCC6 package. These high performance tricolor SMT LEDs are designed to work in a wide range of applications. A wide viewing angle and high brightness make these LEDs suitable for outdoor and full color video signage applications.

The encapsulation resin contains UV inhibitors to minimize the effects of long-term exposure to direct sunlight, resulting in stable light output over the life of the LED. This PLCC6 package has an increased package height to ease in the manufacturing process.

## FEATURES

- Size (mm): 3.5 x 3.4 x 2.8
- Dominant Wavelength:  
Red (619 - 624nm)  
Green (520 - 540nm)  
Blue (460 - 480nm)
- Luminous Intensity (mcd)  
Red (560-1120)  
Green (900 - 1800)  
Blue (140-355)
- Water-Resistant (IPX8)\*
- Moisture Sensitivity Level: 5a
- Lead-Free
- RoHS Compliant
- Matte Surface

## APPLICATIONS

- Architecture Lighting
- Outdoor Full-Color Video Screen
- Decorative lighting
- Amusement

\*: This part is tested under the condition of assembling it on a PCB with isolating the electrical path by silicone. The leads area of the LED is not IPx8 rated and it's required to insulate for moisture by customer in outdoor application.

### ABSOLUTE MAXIMUM RATINGS ( $T_A = 25^\circ\text{C}$ )

Items	Symbol	Absolute Maximum Rating			Unit
		R	G	B	
Forward Current <sup>Note 1</sup>	$I_F$	50	35	35	mA
Peak Forward Current <sup>Note 2</sup>	$I_{FP}$	200	100	100	mA
Reverse Voltage	$V_R$	5	5	5	V
Power Dissipation	$P_D$	130	119	133	mW
Operation Temperature	$T_{opr}$	-40 ~ +85			$^\circ\text{C}$
Storage Temperature	$T_{stg}$	-40 ~ +100			$^\circ\text{C}$
Junction Temperature	$T_J$	110	110	110	$^\circ\text{C}$
Junction/ambient 1 chip on	$R_{THJA}$	450	400	450	$^\circ\text{C}/\text{W}$
Junction/solder point 1 chip on	$R_{THJS}$	230	230	200	$^\circ\text{C}/\text{W}$
Electrostatic Discharge Classification(MIL-STD-883E)	ESD	1000 V			

**Note:** 1.Single-color light.  
2.Pulse width  $\leq 0.1$  msec, duty  $\leq 1/10$ .

### TYPICAL ELECTRICAL & OPTICAL CHARACTERISTICS ( $T_A = 25^\circ\text{C}$ )

Characteristics	Condition	Symbol	Values			Unit
			R	G	B	
Dominant Wavelength	$I_F = 15 \text{ mA(R)}$ $I_F = 10 \text{ mA(G)}$ $I_F = 10 \text{ mA(B)}$	$\lambda_{DOM}$	619~624	520~540	460~480	nm
Spectral bandwidth at 50% $I_{REL}$ max	$I_F = 15 \text{ mA(R)}$ $I_F = 10 \text{ mA(G)}$ $I_F = 10 \text{ mA(B)}$	$\Delta \lambda$	24	38	28	nm
Forward Voltage	$I_F = 15 \text{ mA(R)}$ $I_F = 10 \text{ mA(G)}$ $I_F = 10 \text{ mA(B)}$	$V_{F(avg)}$	2.1	2.7	3.0	V
		$V_{F(max)}$	2.6	3.4	3.8	V
Luminous Intensity	$I_F = 15 \text{ mA(R)}$ $I_F = 10 \text{ mA(G)}$ $I_F = 10 \text{ mA(B)}$	$I_{V(min)}$	560	900	140	mcd
		$I_{V(avg)}$	750	1350	240	mcd
Luminous Flux(Reference)	$I_F = 15 \text{ mA(R)}$ $I_F = 10 \text{ mA(G)}$ $I_F = 10 \text{ mA(B)}$	$\Phi_{V(avg)}$	1.9	3.4	0.7	lm
Luminous Intensity(Reference)	$I_F = 20 \text{ mA}$	$I_{V(avg)}$	950	2100	480	mcd
Reverse Current (max)	$V_R = 5 \text{ V}$	$I_R$	10	10	10	$\mu\text{A}$

**Note:** Continuous reverse voltage can cause LED damage.

**INTENSITY BIN LIMIT (RED  $I_F = 15$  mA, GREEN  $I_F = 10$  mA, BLUE  $I_F = 10$  mA)**

Red

Bin Code	Min.(mcd)	Max.(mcd)
K	560	710
np	635	805
M	710	900
qr	805	1010
N	900	1120

Green

Bin Code	Min.(mcd)	Max.(mcd)
N	900	1120
st	1010	1260
P	1120	1400
vw	1260	1600
Q	1400	1800

Blue

Bin Code	Min.(mcd)	Max.(mcd)
D	140	180
9a	160	202
E	180	224
bc	202	252
F	224	280
de	252	318
G	280	355

Tolerance of measurement of luminous intensity is  $\pm 10\%$ .

**COLOR BIN LIMIT (RED  $I_F = 15$  mA, GREEN  $I_F = 10$  mA, BLUE  $I_F = 10$  mA)**

Red

Bin Code	Min.(nm)	Max.(nm)
RB	619	624

Green

Bin Code	Min.(nm)	Max.(nm)
G7	520	525
G23	522.5	527.5
G8	525	530
G45	527.5	532.5
G9	530	535
G67	532.5	537.5
Ga	535	540

Blue

Bin Code	Min.(nm)	Max.(nm)
B3	460	465
B23	462.5	467.5
B4	465	470
B45	467.5	472.5
B5	470	475
B67	472.5	477.5
B6	475	480

Tolerance of measurement of dominant wavelength is  $\pm 1$  nm.

## ORDER CODE TABLE\*

Kit Number	Color	Luminous Intensity (mcd)		Dominant Wavelength (nm)				Pack- age
		Min.	Max.	Color Bin	Min. (nm)	Color Bin	Max. (nm)	
CLX6F-FKC-CKNNQDGBB7a363	Red	560	1120	RB	619	RB	624	Reel
	Green	900	1800	G7	520	Ga	540	Reel
	Blue	140	355	B3	460	B6	480	Reel
CLX6F-FKC-CK1N1D1BB7D3D3	Red	Any 1 Intensity bin from K(560) - N(1120)		RB	619	RB	624	Reel
	Green	Any 1 Intensity bin from N(900) - Q(1800)		Any 1 hue bin from G7(520) - Ga(540)			Reel	
	Blue	Any 1 Intensity bin from D(140) - G(355)		Any 1 hue bin from B3(460) - B6(480)			Reel	
CLX6F-FKC-Cnp1st1E1BB7D3D3	Red	Any 1 Intensity bin from np(635) - N(1120)		RB	619	RB	624	Reel
	Green	Any 1 Intensity bin from st(1010) - Q(1800)		Any 1 hue bin from G7(520) - Ga(540)			Reel	
	Blue	Any 1 Intensity bin from E(180) - G(355)		Any 1 hue bin from B3(460) - B6(480)			Reel	

### Notes:

1. The above kit numbers represent the order codes which include multiple intensity-bin and color-bin codes. Only one intensity-bin code and one color-bin code will be shipped on each reel. Single intensity-bin code and single color-bin code will be orderable in certain quantities. For example, any 1 intensity bin from N - Q means only 1 intensity bin (N or st or P or vw or Q) will be shipped by Cree. For example, any 1 color bin from G7 - Ga means only 1 color bin (G7 or G23 or G8 or G45 or G9 or G67 or Ga) will be shipped by Cree.
2. Please refer to the "Cree LED Lamp Reliability Test Standards" document <sup>#1</sup> for reliability test conditions.
3. Please refer to the "Cree LED Lamp Soldering & Handling" document <sup>#2</sup> for information about how to use this LED product safely.

#1: Refer to [http://www.cree.com/led-components/media/documents/LED\\_Lamp\\_Reliability\\_Test\\_Standard.pdf](http://www.cree.com/led-components/media/documents/LED_Lamp_Reliability_Test_Standard.pdf)

#2: Refer to <http://www.cree.com/led-components/media/documents/sh-HB.pdf>

## GRAPHS

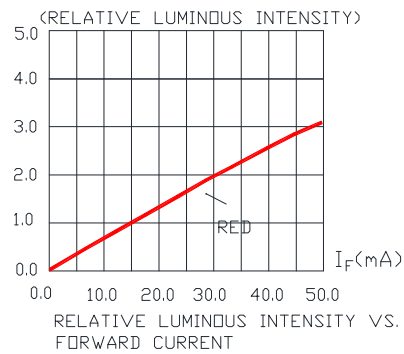
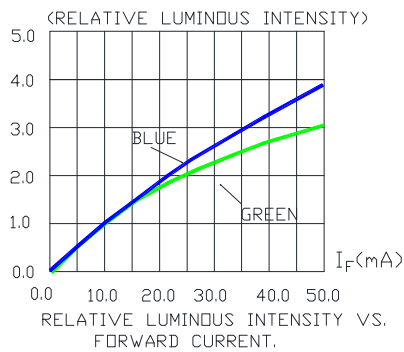
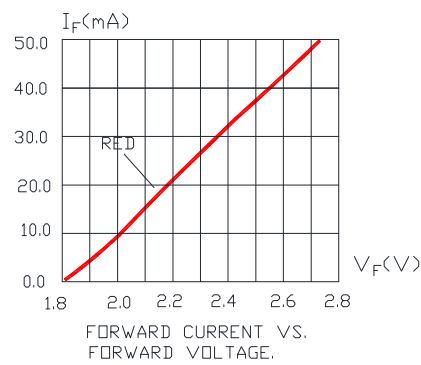
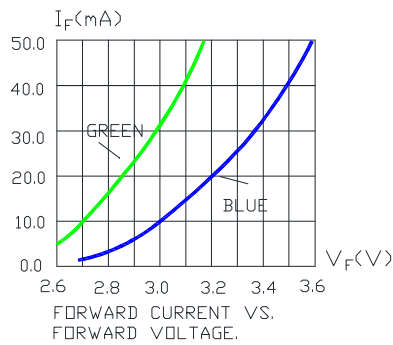
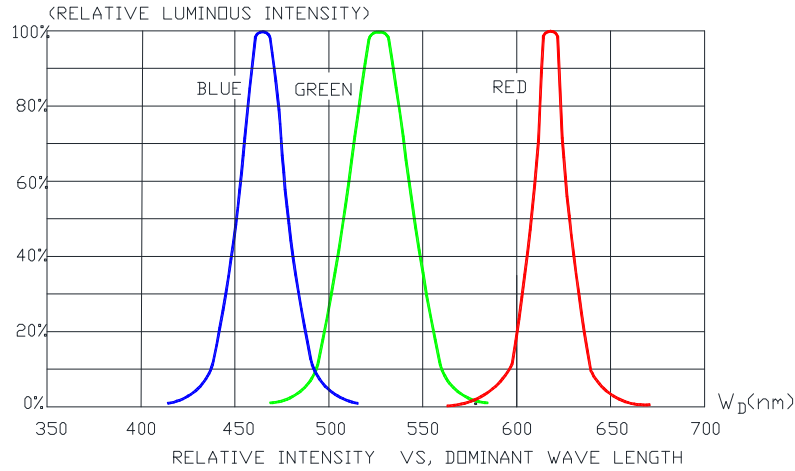

The above data are collected from statistical figures that do not necessarily correspond to the actual parameters of each single LED. Hence, these data will be changed without further notice.

## GRAPHS

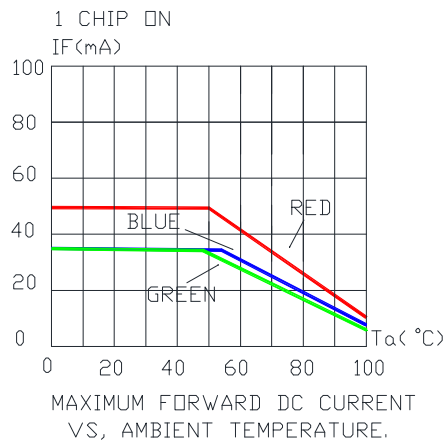
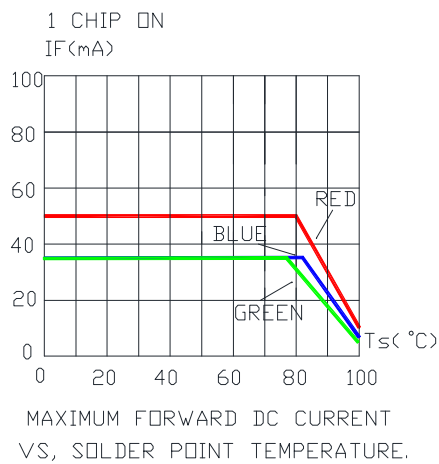
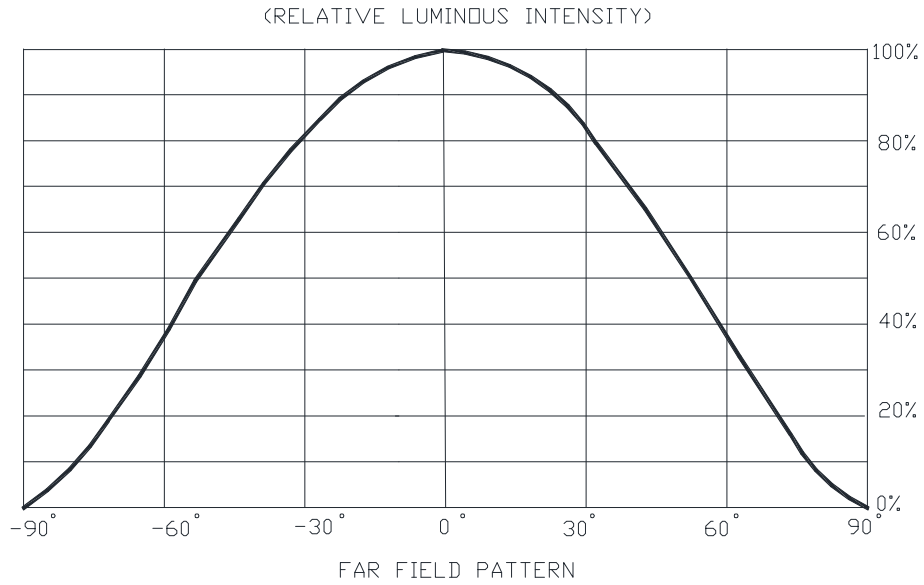

The above data are collected from statistical figures that do not necessarily correspond to the actual parameters of each single LED. Hence, these data will be changed without further notice.

## MECHANICAL DIMENSIONS

All dimensions are in mm.

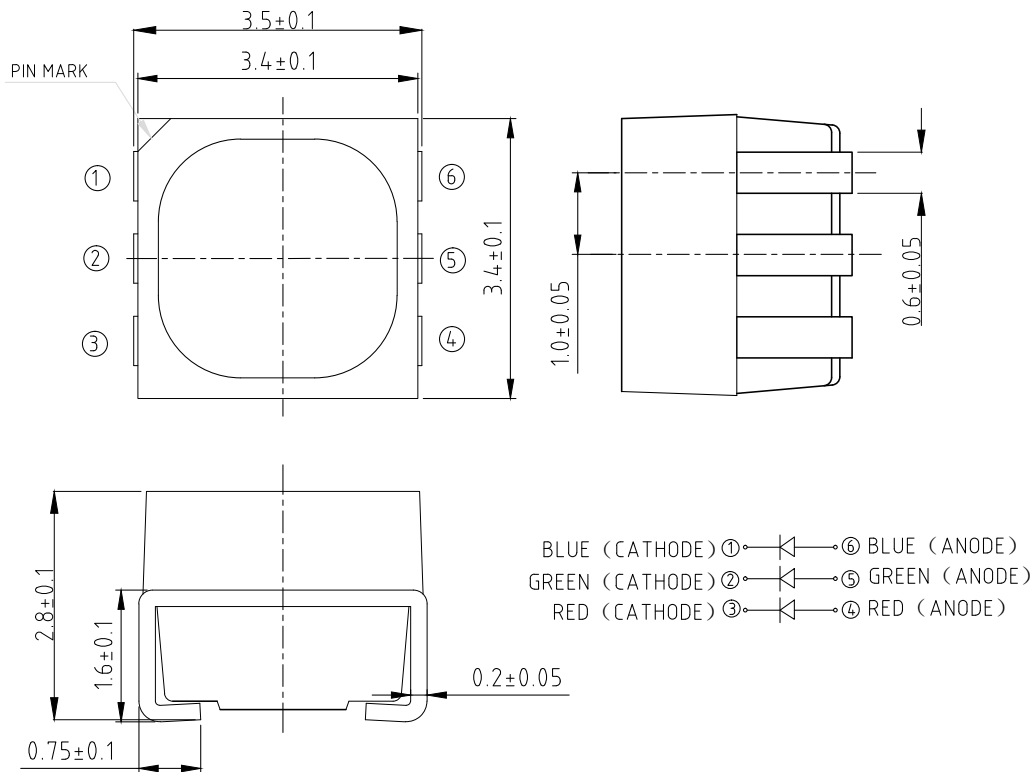

## NOTES

### RoHS Compliance

The levels of environmentally sensitive, persistent biologically toxic (PBT), persistent organic pollutants (POP), or otherwise restricted materials in this product are below the maximum concentration values (also referred to as the threshold limits) permitted for such substances, or are used in an exempted application, in accordance with EU Directive 2002/95/EC on the restriction of the use of certain hazardous substances in electrical and electronic equipment (RoHS), as amended through April 21, 2006.

### Vision Advisory Claim

Users should be cautioned not to stare at the light of this LED product. The bright light can damage the eye.

## KIT NUMBER SYSTEM

Cree LED lamps are tested and sorted into performance bins. A bin is specified by ranges of color, forward voltage, and brightness. Sorted LEDs are packaged for shipping in various convenient options. Please refer to the "Cree LED Lamp Packaging Standard" document for more information about shipping and packaging options.

Cree LEDs are sold by order codes in combinations of bins called kits. Order codes are configured in the following manner:





## RELIABILITY

### Tests and Results

Test	Applicable Standards	Test Condition	Note	Number of Damaged
Temperature Cycle	JEITA ED-4701 100 105	-40°C~25°C~100°C~25°C 30 mins, 5 mins, 30 mins, 5 mins	100 cycles	0/50
Thermal Shock	MIL-STD-202G	-40°C~100°C 30 mins, 30 mins	100 cycles	0/50
Moisture Resistance	JEITA ED-4701 200 203	25°C~65°C~ 90%RH 24hrs/1cycle	10 cycles	0/50
High Temperature Storage	JEITA ED-4701 200 201	T <sub>A</sub> =100°C	500 hrs	0/50
Temperature Humidity Storage	JEITA ED-4701 100 103	T <sub>A</sub> =60°C RH=90%	500 hrs	0/50
Low Temperature Storage	JEITA ED-4701 200 202	T <sub>A</sub> =-40°C	500 hrs	0/50
Water Proof Test*	IEC 60529:2001	IP X8 Immersing in 1m water	24hrs	0/50
High Temperature Life Test	-	T <sub>A</sub> =85°C I <sub>F</sub> =15 mA	1000 hrs	0/50
Life Test	-	T <sub>A</sub> =25°C IF: R=30mA G=35mA B=20mA	1000 hrs	0/50
High Humidity Heat Life Test	-	60°C RH=90% I <sub>F</sub> =15 mA	500 hrs	0/50
Low Temperature Life Test	-	T <sub>A</sub> =-40°C IF: R=30mA G=35mA B=20mA	500 hrs	0/50
Resistance to Soldering Heat(Reflow Soldering)	JEITA ED-4701 300 301	T <sub>sol</sub> =250°C,10sec (Pre treatment 30°C,70%,168hrs)	2 times	0/50
Vibration-variable Frequency	MIL-STE-883 Method 2007	20G min, 20 to 2000Hz, 4cycles, 4mins, Each x,y,z		0/50
Electrostatic Discharge Test	AEC(Q101-001)	Human body model 1000 V (Forward and reverse current conduct electricity each 1time)		0/50

Water proof test\*: The test is conducted on component level. It is strongly recommended the customers test the products for their application

### Failure Criteria

Item	Symbol	Test Condition	Criteria for Judgment	
			Min.	Max.
Forward Voltage	V <sub>F</sub>	I <sub>F</sub> = 20 mA	-	Initial Data x 1.1
Reverse Current	I <sub>R</sub>	V <sub>R</sub> = 5 V	-	10 μA
Luminous Flux/Intensity	Φ <sub>V</sub>	I <sub>F</sub> = 20 mA	Initial Data x 0.7	-
Resistance to Soldering Heat	-	I <sub>F</sub> = 20 mA	No dead lamps and visual damage	
Vibration-variable Frequency	-	I <sub>F</sub> = 20 mA	No dead lamps and visual damage	

## REFLOW SOLDERING

- The CLX6F-FKC is rated as a MSL 5a product.
- The recommended floor life out of bag is 24hrs. .
- The temperature profile is as below.

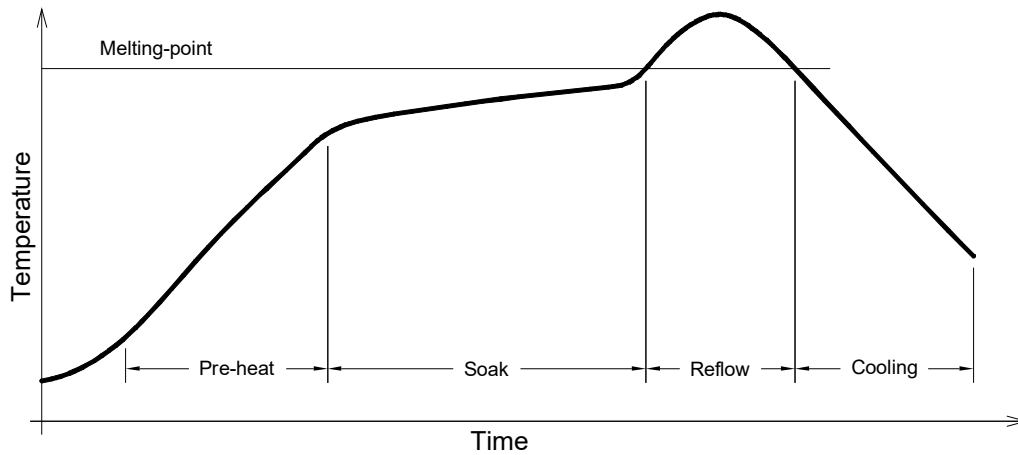

Use only with CLX6F-FKC

Solder
Average ramp-up rate = 4°C/s max
Preheat temperature = 150°C ~200°C
Preheat time = 120s max
Ramp-down rate = 6°C/s max
Peak temperature = 250°C max
Time within 5°C of actual Peak Temperature = 10s max
Duration above 217°C is 60s max

Refer to "<http://www.cree.com/led-components/media/documents/sh-HB.pdf>" for soldering & handling details.

## NOTES

---

- The packaging sizes of these SMD products are very small and the resin is still soft after solidification. Users are required to handle with care. Never touch the resin surface of SMD products.
- To avoid damaging the product's surface and interior device, it is recommended to choose a special nozzle to pick up the SMD products during the process of SMT production. If handling is necessary, take special care when picking up these products. The following method is necessary:

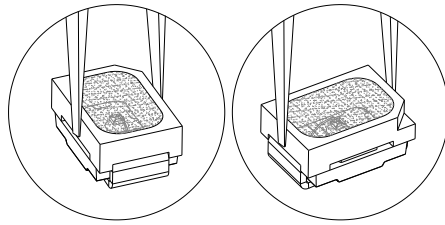

## PACKAGING

- The boxes are not water resistant and they must be kept away from water and moisture.
- The LEDs are packed in cardboard boxes after packaging in normal or anti-electrostatic bags.
- Cardboard boxes will be used to protect the LEDs from mechanical shocks during transportation.
- The reel pack is applied in SMD LED.
- Max 2800 pcs per reel.

