

C900AH SFTY X1-400 Y1-400, Ceramic, 3300 pF, 20%, 400 VAC (X1), 400 VAC (Y1), Y5U, Lead Spacing = 10mm

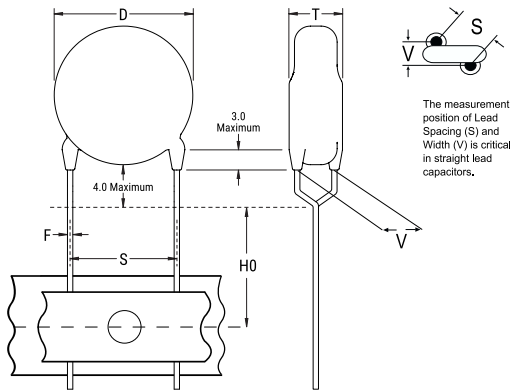

Dimensions

D	12mm MAX
T	5mm MAX
S	10mm +/-1mm
H0	18mm +2/-0mm
F	0.55mm +/-0.1mm

Packaging Specifications

Packaging:	Ammo
Packaging Quantity:	1000

General Information

Supplier:	KEMET
Series:	C900AH SFTY X1-400 Y1-400
Style:	Radial Disc
RoHS:	Yes
Termination:	Tin
Failure Rate:	N/A
Qualifications:	UL, ENEC, VDE, CSA, CAN
Halogen Free:	Yes

Specifications

Capacitance:	3300 pF
Capacitance Tolerance:	20%
Voltage AC:	400 VAC (X1), 400 VAC (Y1)
Dielectric Withstanding Voltage:	4000 VDC
Temperature Range:	-40/+125°C
Temperature Coefficient:	Y5U
Dissipation Factor:	2.50%
Insulation Resistance:	10 GOhms
Safety Class:	X1/Y1