



Tango 24

DUAL BAND WIFI 2.4/5.8 GHZ WITH LTE BANDS THROUGH HOLE MOUNT ANTENNA

Key Features

- 2.4GHz / 5.8GHz Dual Band WiFi Antenna
- Some LTE Bands Covered
- Compact Puck Design



General Description

The Tango 24 is a compact, puck shaped antenna, tuned to 2.4GHz - 5.8 GHz WiFi//Bluetooth/ Zigbee frequencies. The coverage also allows for the antenna to be used with some of the LTE bands.

The Tango 24 screw base, through hole design allows secure mounting onto the case of the product.

Typical applications include vending machines, point of sales terminals and kiosks.

Supplied as standard with an SMA Male connector with reverse polarity for WiFi and a standard SMA Male for LTE. Alternative connectors and cable lengths may be specified for volume orders.

Additional Considerations

- Bluetooth / Zigbee / ISM 2450MHz
- Screw threaded base for secure mounting
- Omni directional radiation

T Through	WLAN 2400	ISM 2450	BLE Bluetooth
ZB Zigbee	WLAN 5800	4G LTE	5G LTE
IP 67			



Tango 24

DUAL BAND WIFI 2.4/5.8 GHZ WITH LTE BANDS THROUGH HOLE MOUNT ANTENNA

Electrical Specifications

Impedance:	50 Ohm
Power capacity:	50W
Polarization:	Vertical

Environmental Specifications

Operating Temperature:	-30 - +75°C
Storage Temperature:	-30 - +75°C

Mechanical Specifications

Dimensions:	46 Ø x H15mm
Connector:	SMA Male Reverse Polarity
Cable:	RG174
Mounting Method:	M12 Screw
Maximum Material Thickness:	3.5mm

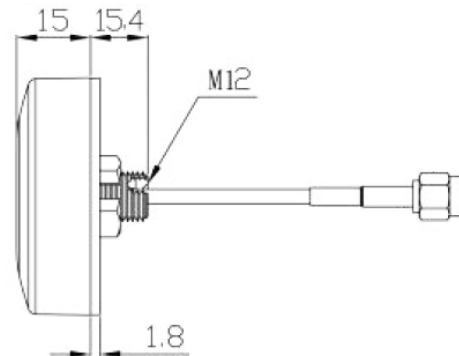
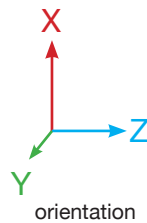

Return Loss tested with 1m cable

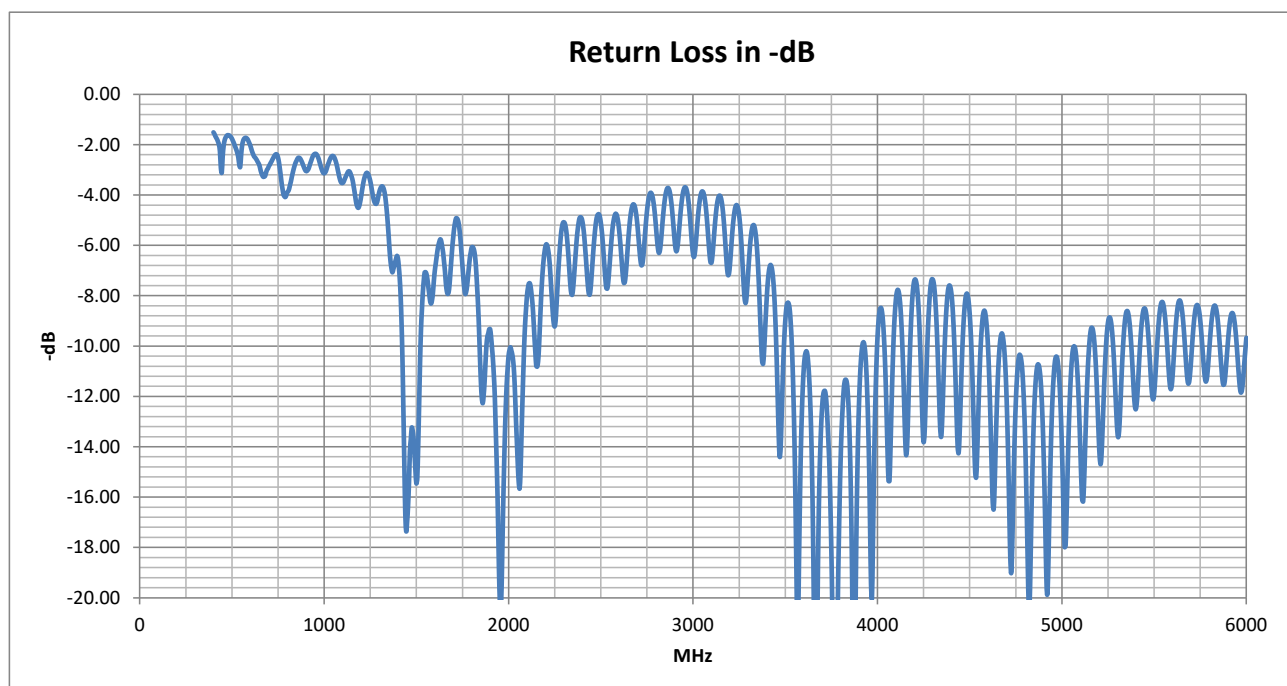



Tango 24

DUAL BAND WIFI 2.4/5.8 GHZ WITH LTE BANDS THROUGH HOLE MOUNT ANTENNA

VSWR tested with 1m cable

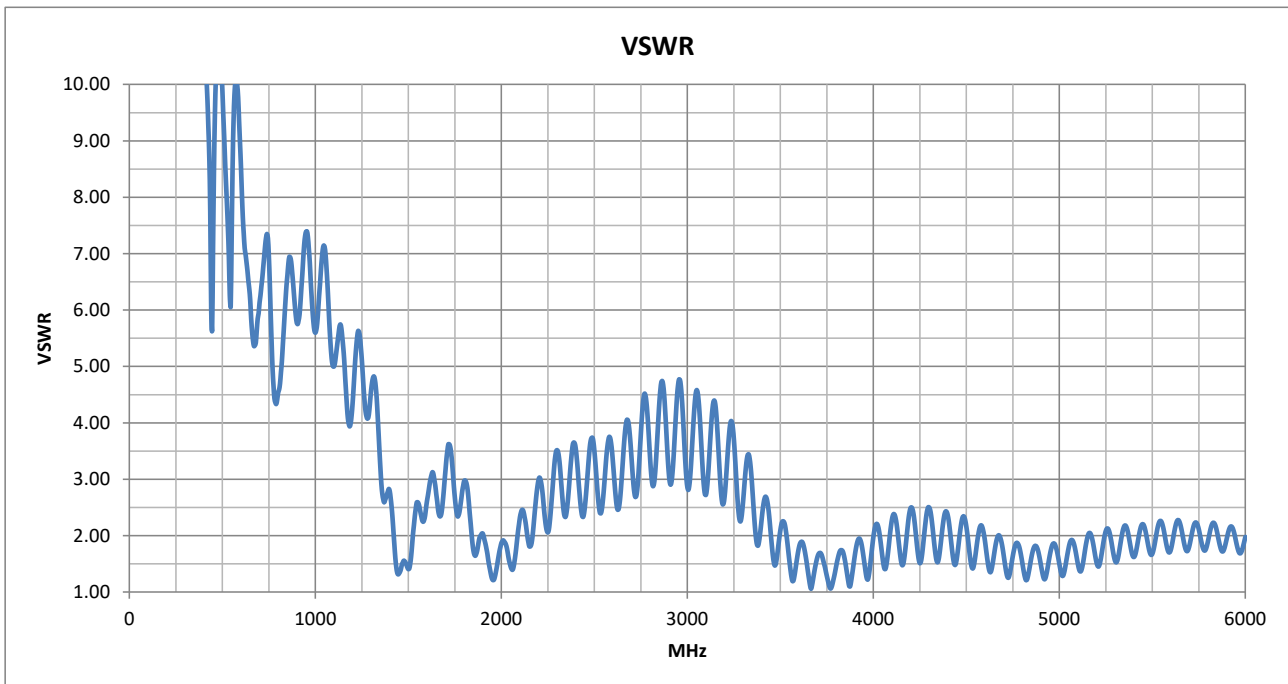

Radiation Efficiency tested with 1m cable

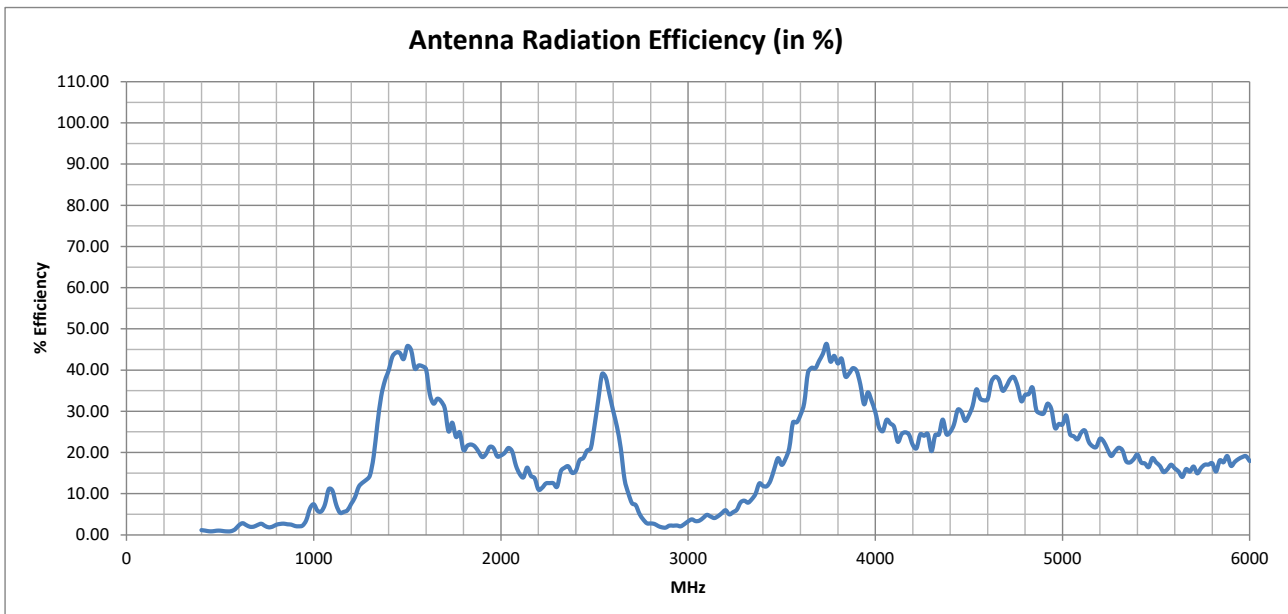



LTE/5G Band Coverage

LTE, CAT-M/5G Bands	NB-IoT Band	Regional Coverage	Uplink	Downlink	Avg Efficiency % over band	Max VSWR over Band
2/n2	B2	North America/Latin America/Caribbean	1850-1910 MHz	1930-1990 MHz	20.43 / 20.07 ●	2.04 / 1.73
3/n3	B3	Europe/Africa/Asia/Oceania	1710-1785 MHz	1805-1880 MHz	25.38 / 21.17 ●	3.62 / 2.98
11	B11	Country Specific	1427.9-1447.9 MHz	1475.9-1495.9 MHz	43.89 / 44.21 ●	1.83 / 1.56
21		Country Specific	1447.9-1462.9 MHz	1495.9-1510.9 MHz	43.69 / 44.45 ●	1.49 / 1.50
n24		-----	1626.5 - 1660.5 MHz	1525 - 1559 MHz	33.00 / 42.12 ●	3.13 / 2.59
25/n25	B25	Country Specific	1850-1915 MHz	1525-1559 MHz	20.43 / 42.12 ●	2.04 / 2.59
38/n38		Europe +	2570-2620 MHz		31.10 ●	3.75
43		Country Specific	3600-3800 MHz		40.10 ●	1.89
46		Country Specific	5150-5925 MHz		18.00 ●	2.28
48/n48		Country Specific	3550-3700 MHz		33.26 ●	1.89
n50		-----	1432 /1517 MHz		44.17 ●	1.61
n51		-----	1427 - 1432 MHz		43.76 ●	1.83
n53		-----	2483.5 - 2495 MHz		23.76 ●	3.74
65/n65		Country Specific	1920-2010 MHz	2110-2200 MHz	20.04 / 14.03 ○	1.92 / 2.99
66/n66	B66	Country Specific	1710-1780 MHz	2110-2200 MHz	26.34 / 14.03 ○	3.62 / 2.99
n74			1427 - 1470 MHz	1475 - 1518 MHz	43.58 / 44.38 ●	1.83 / 1.83
n75		-----	1432 -1517 MHz		44.17 ●	1.61
n76		-----	1427 - 1432 MHz		43.76 ●	1.83
n79		-----	4400 - 5000 MHz		32.19 ●	2.36
n80		-----	1710 - 1785 MHz		25.38 ●	3.62
n86		-----	1710 - 1780 MHz		26.34 ●	3.62
n90		-----	2496 - 2690 MHz		25.01 ●	4.05
n95		-----	2010 - 2025 MHz		20.09 ●	1.92
n99		-----	1626.5 - 1660.5 MHz		33.00 ●	3.13

Table data for bands as detailed in 3GPP TS 36.101 & 38.101

● Usable Band ○ Adequate in good signal area



Tango 24

DUAL BAND WIFI 2.4/5.8 GHz WITH LTE BANDS THROUGH HOLE MOUNT ANTENNA

Radiation Plots tested with 1 m cable

1400 MHz XY

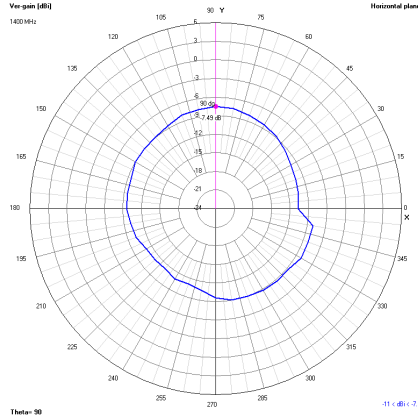

XZ

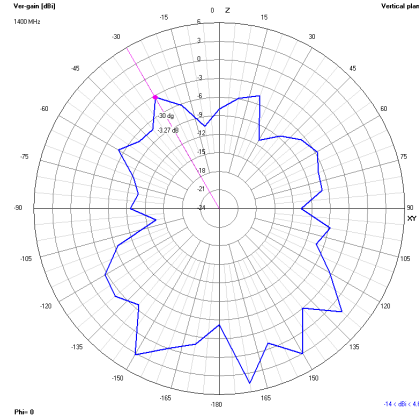

YZ

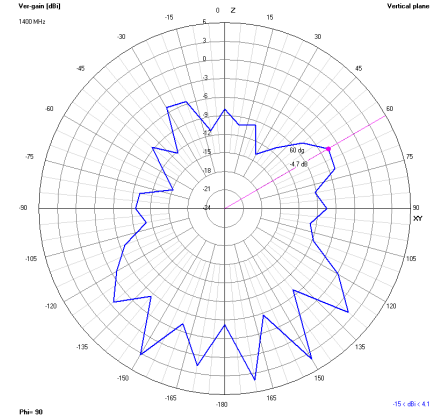

1500 MHz XY

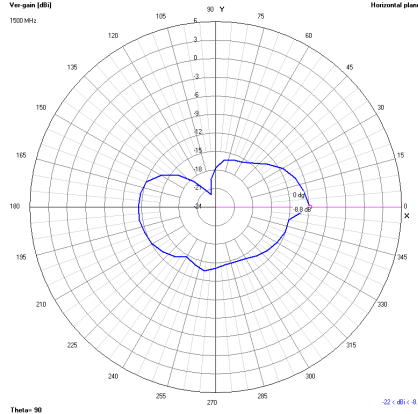

XZ

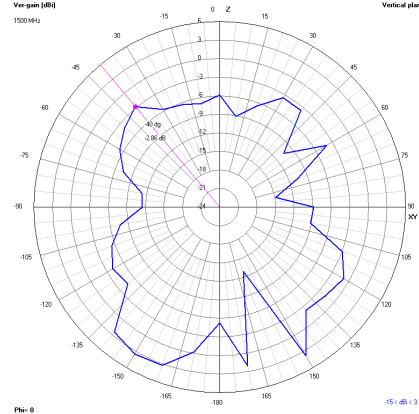

YZ

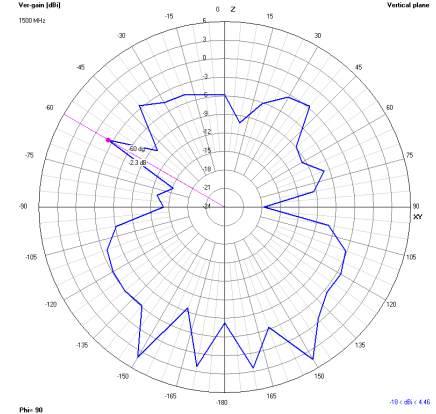

1600 MHz XY

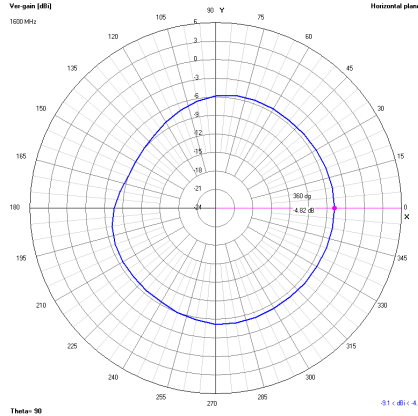

XZ

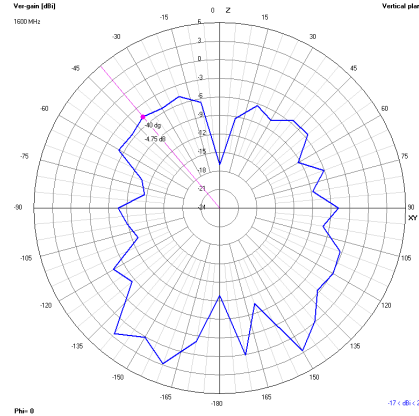

YZ

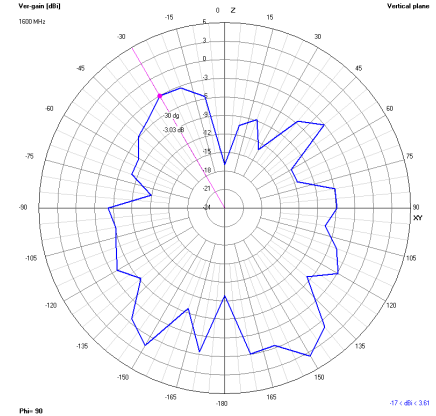



Tango 24

DUAL BAND WIFI 2.4/5.8 GHZ WITH LTE BANDS THROUGH HOLE MOUNT ANTENNA

Radiation Plots tested with 1 m cable

1700 MHz XY

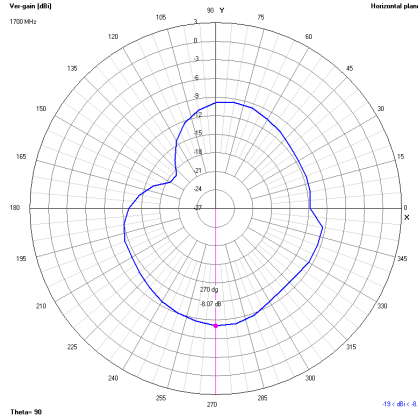

XZ

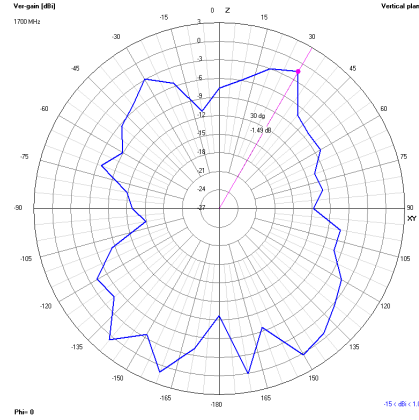

YZ

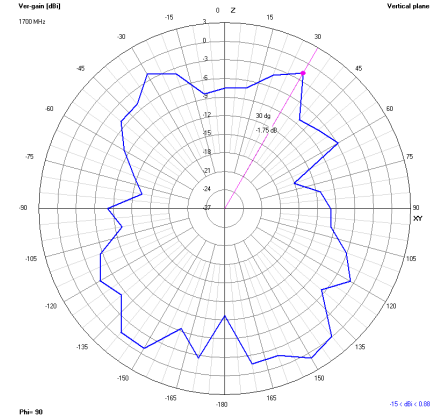

1800 MHz XY

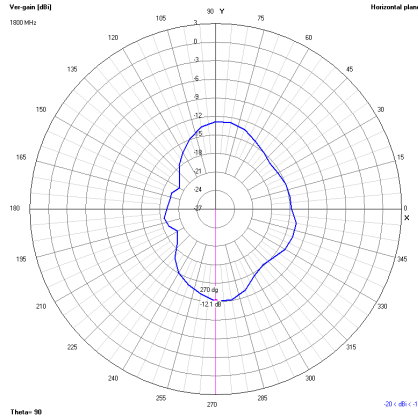

XZ

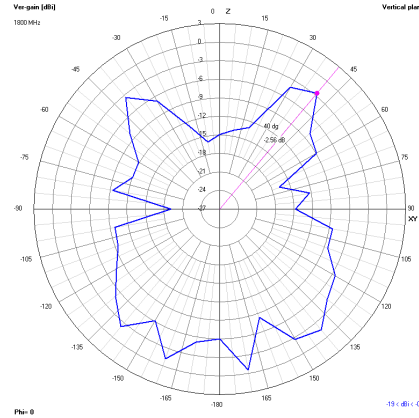

YZ

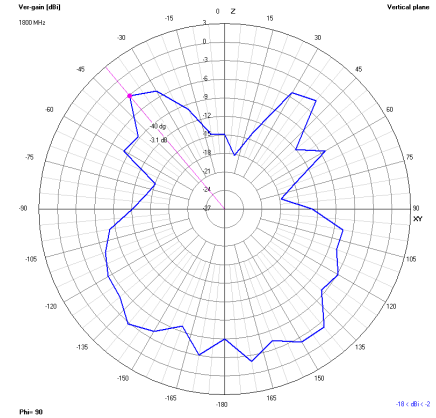

1900 MHz XY

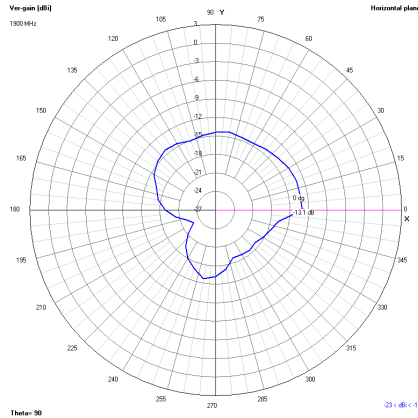

XZ

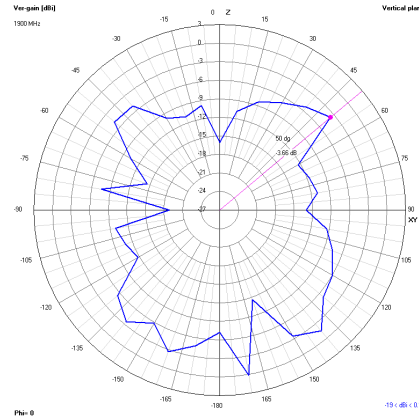

YZ

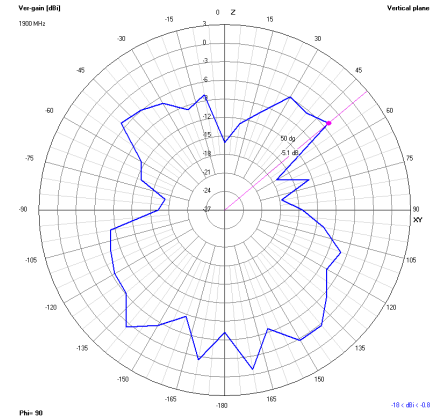



Tango 24

DUAL BAND WIFI 2.4/5.8 GHZ WITH LTE BANDS THROUGH HOLE MOUNT ANTENNA

Radiation Plots tested with 1 m cable

2000 MHz XY

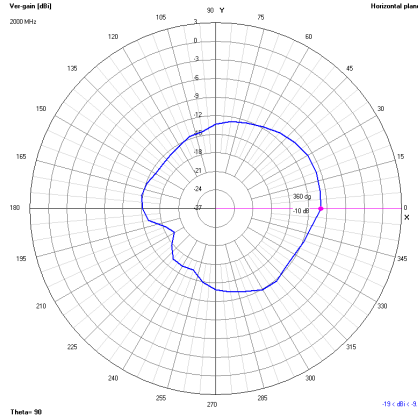

XZ

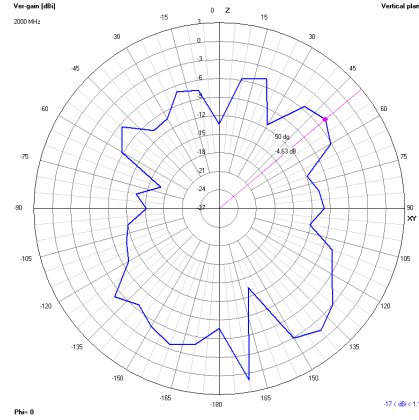

YZ

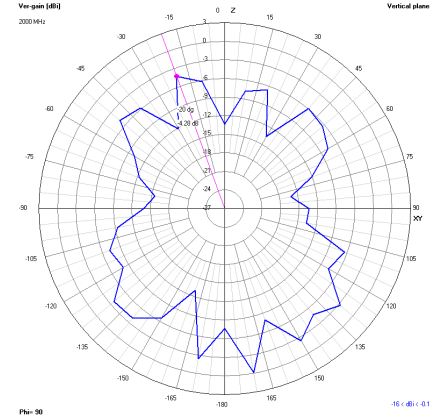

2100 MHz XY

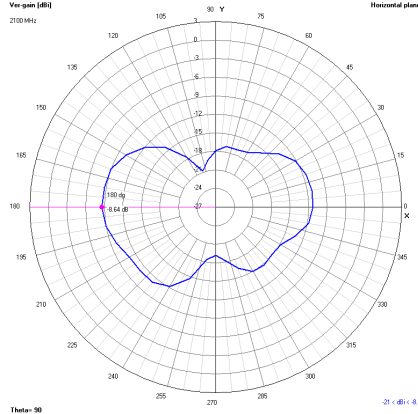

XZ



YZ

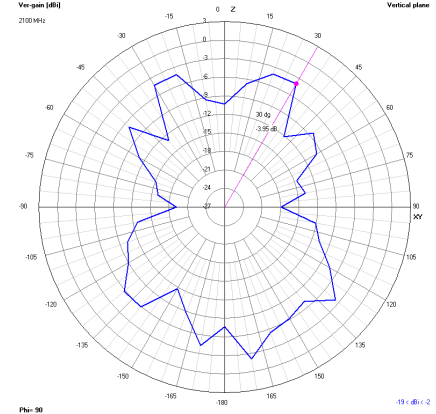

2200 MHz XY

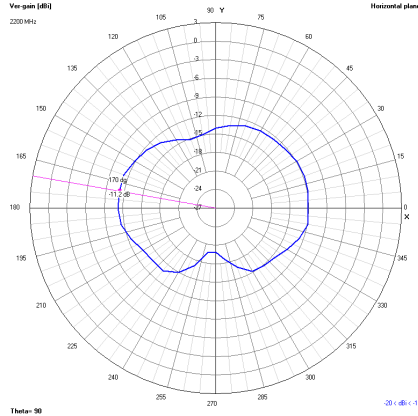

XZ

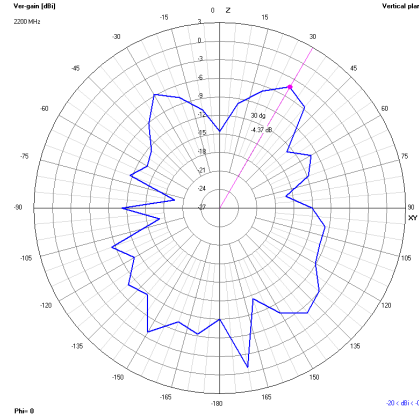

YZ

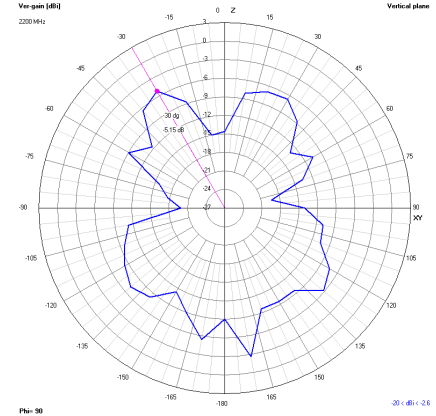



Tango 24

DUAL BAND WIFI 2.4/5.8 GHZ WITH LTE BANDS THROUGH HOLE MOUNT ANTENNA

Radiation Plots tested with 1 m cable

2400 MHz XY

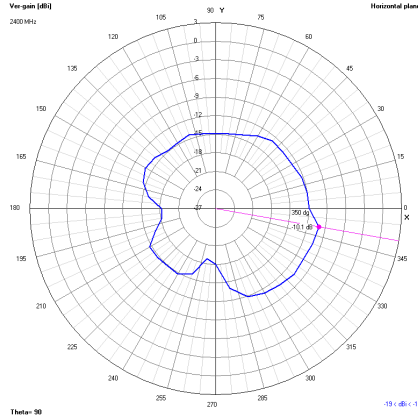

XZ

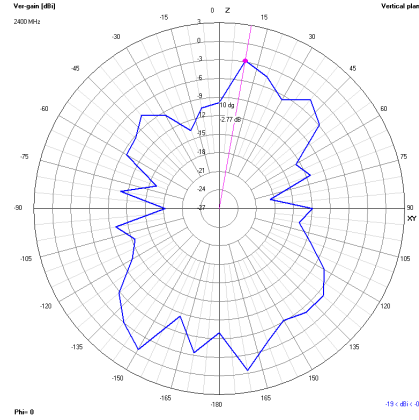

YZ

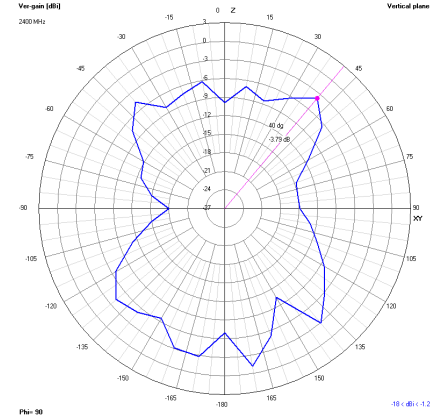

2500 MHz XY

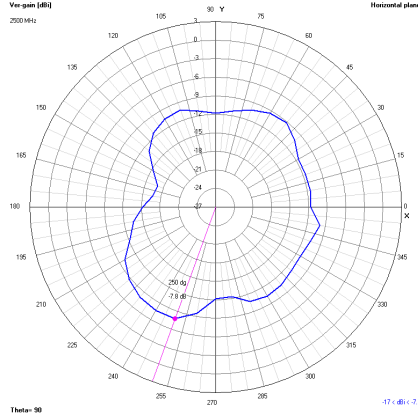

XZ

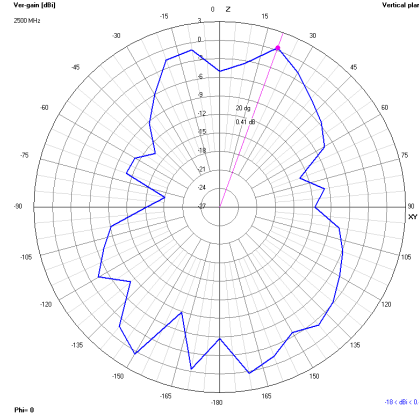

YZ

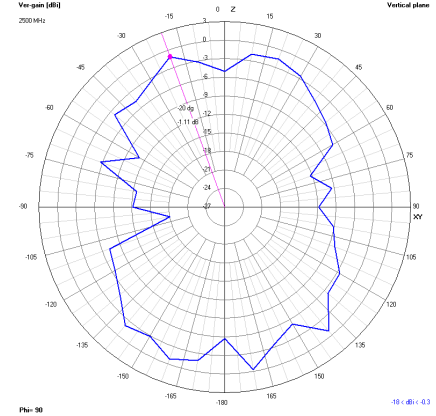

2600 MHz XY

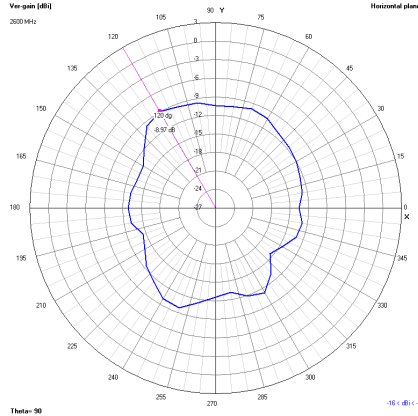

XZ

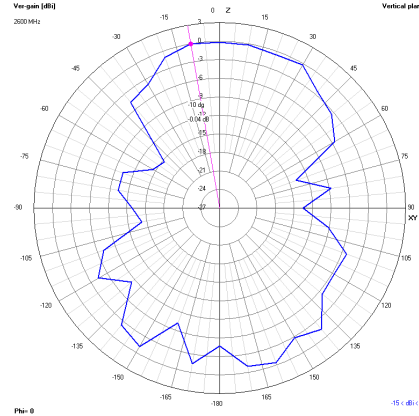

YZ

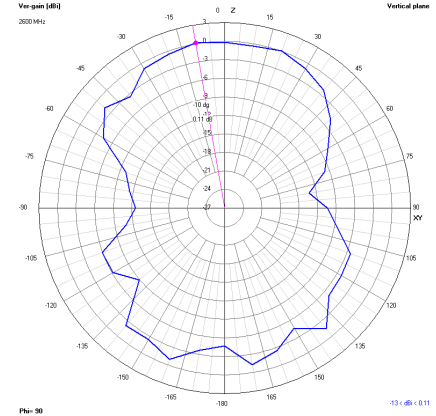



Tango 24

DUAL BAND WIFI 2.4/5.8 GHZ WITH LTE BANDS THROUGH HOLE MOUNT ANTENNA

Radiation Plots tested with 1 m cable

2700 MHz XY

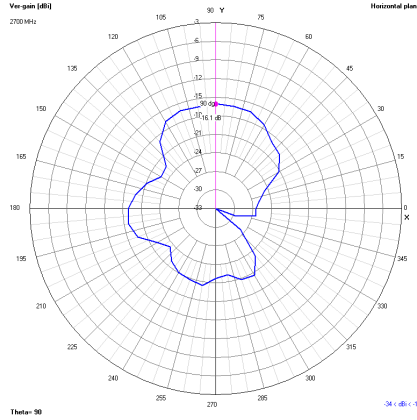

XZ

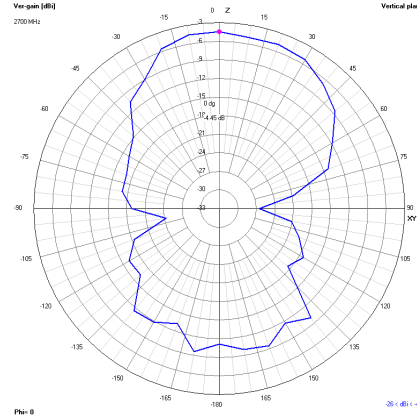

YZ

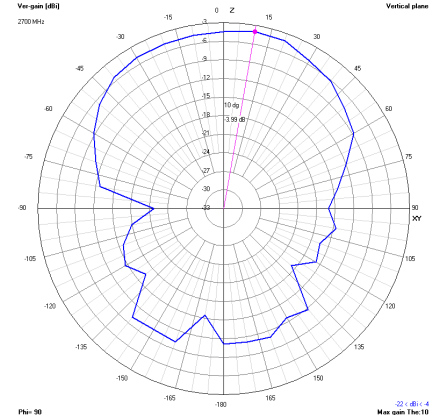

3500 MHz XY

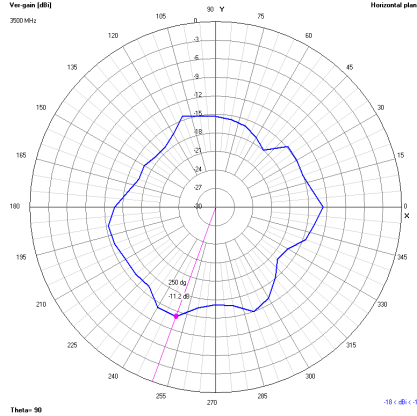

XZ

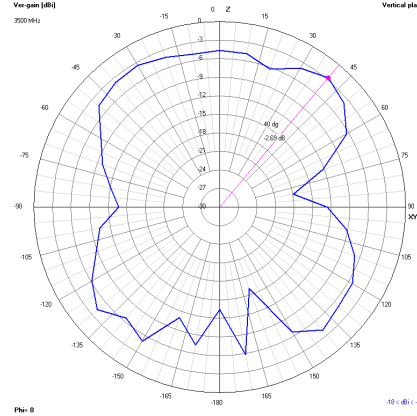

YZ

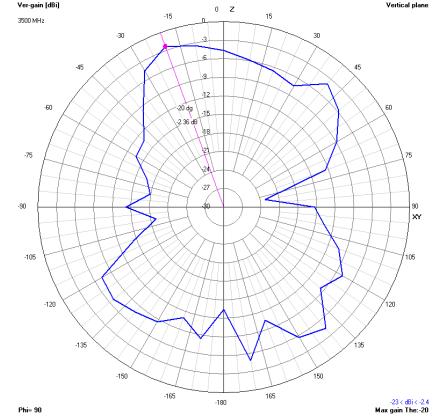

3600 MHz XY

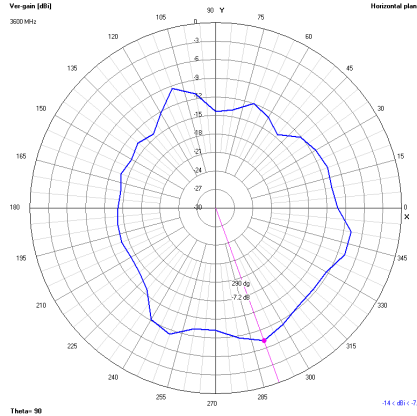

XZ

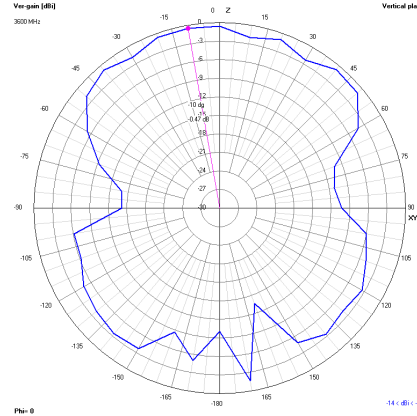

YZ

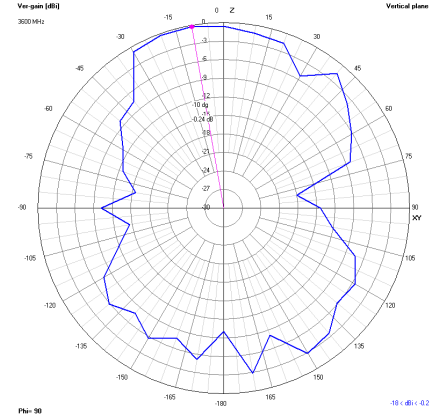



Tango 24

DUAL BAND WIFI 2.4/5.8 GHz WITH LTE BANDS THROUGH HOLE MOUNT ANTENNA

Radiation Plots tested with 1 m cable

3700 MHz XY

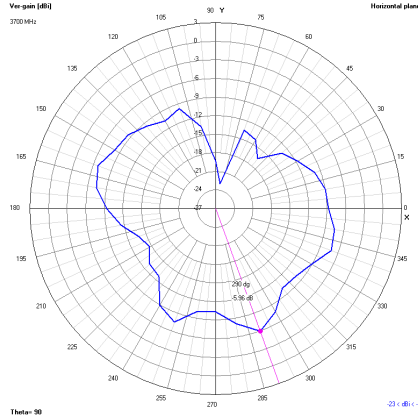

XZ

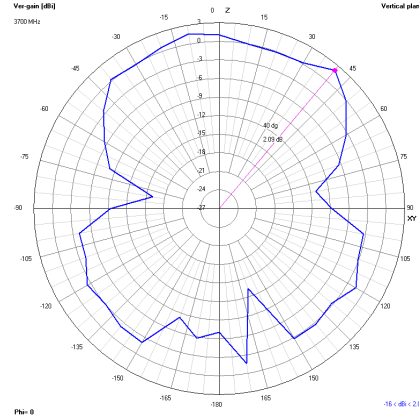

YZ

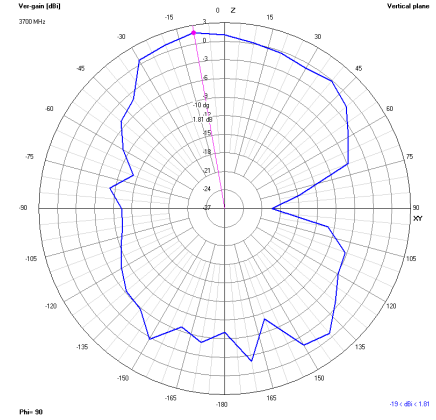

3800 MHz XY

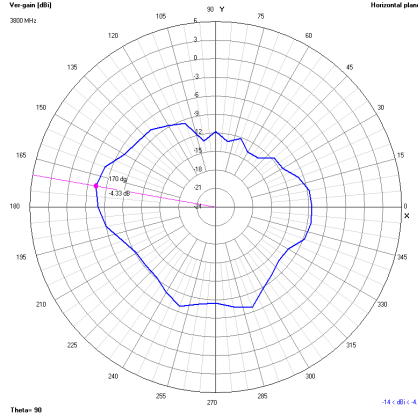

XZ

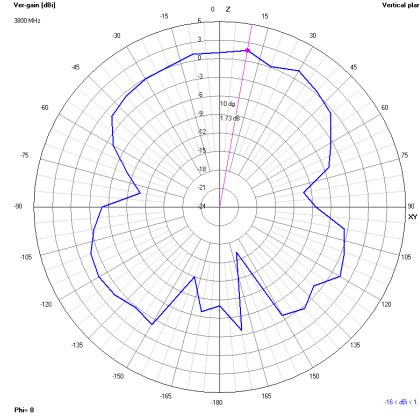

YZ

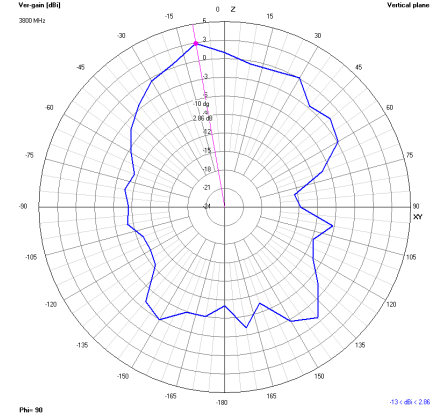

4400 MHz XY

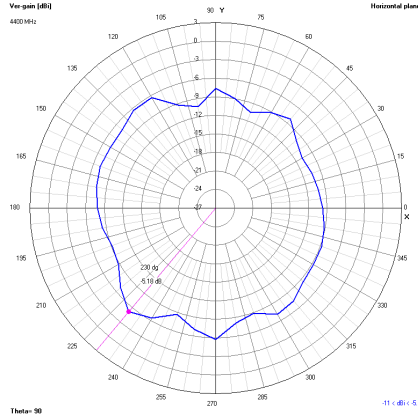

XZ

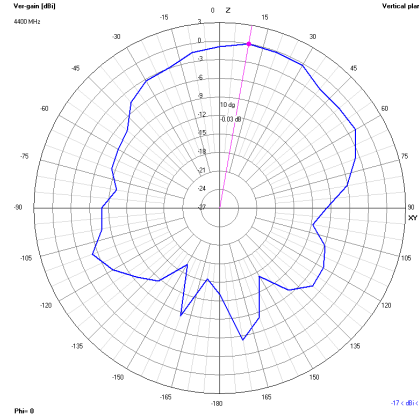

YZ

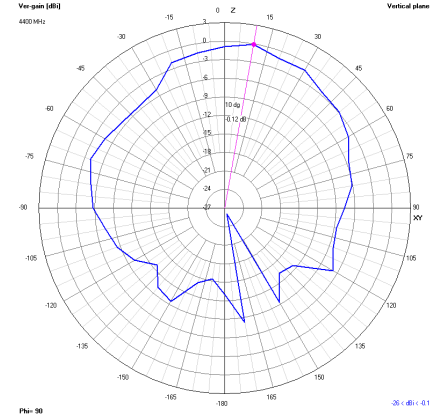



Tango 24

DUAL BAND WIFI 2.4/5.8 GHZ WITH LTE BANDS THROUGH HOLE MOUNT ANTENNA

Radiation Plots tested with 1 m cable

4500 MHz XY

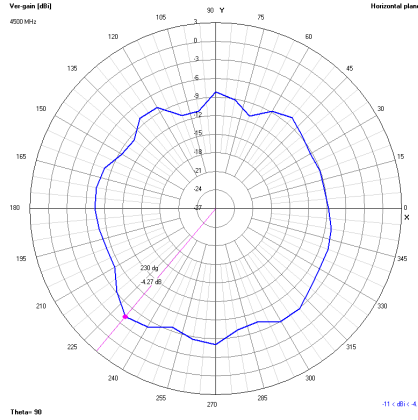

XZ

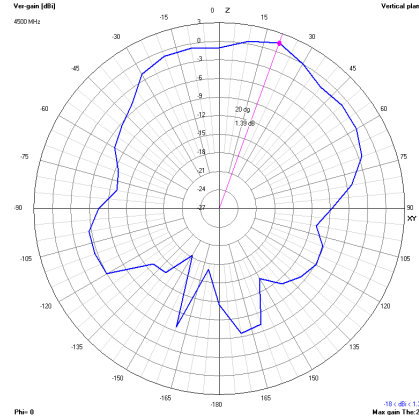

YZ

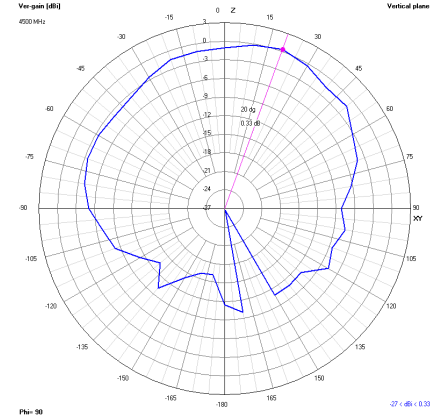

4600 MHz XY

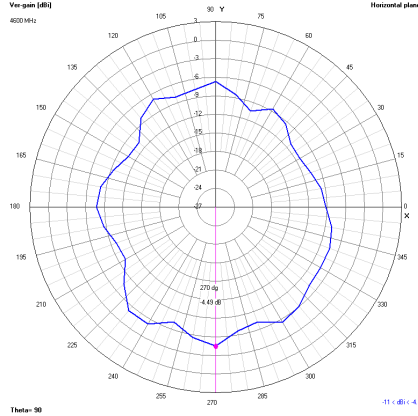

XZ

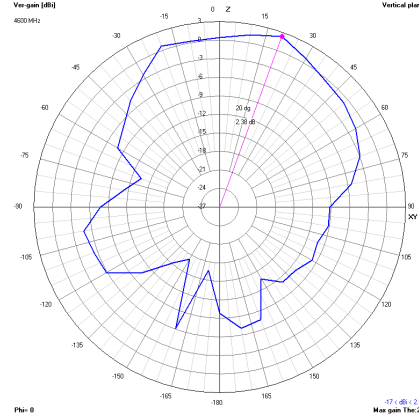

YZ

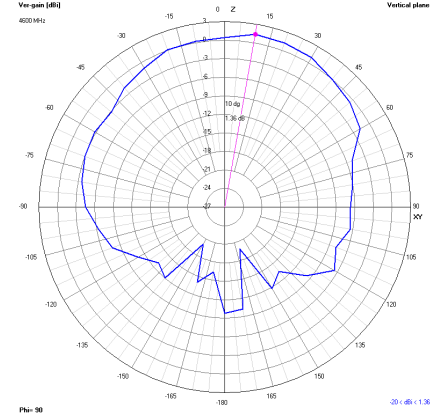

4700 MHz XY

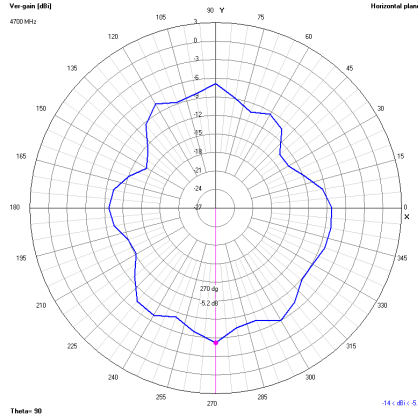

XZ

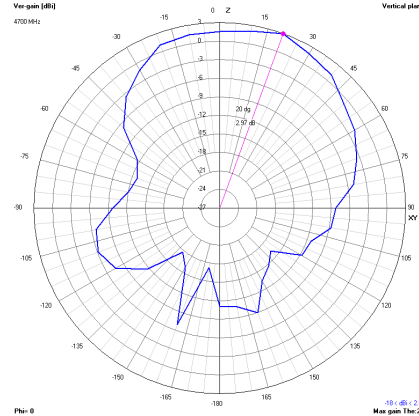

YZ

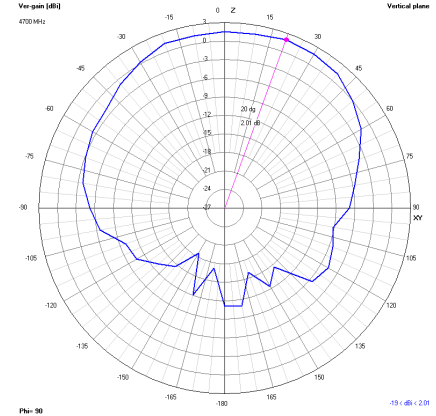



Tango 24

DUAL BAND WIFI 2.4/5.8 GHZ WITH LTE BANDS THROUGH HOLE MOUNT ANTENNA

Radiation Plots tested with 1 m cable

4800 MHz XY

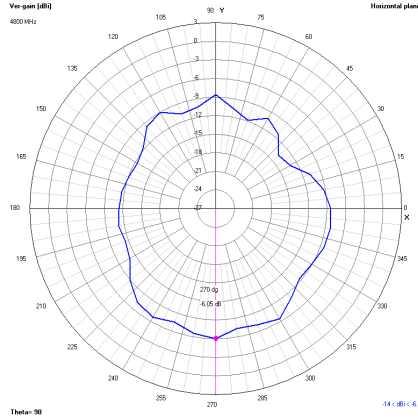

XZ

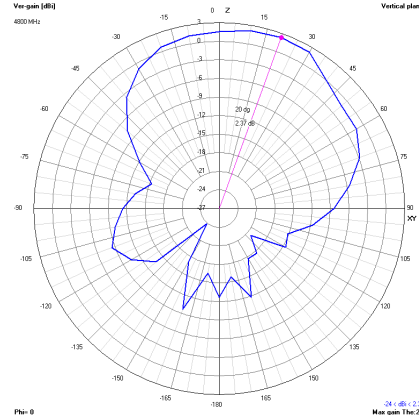

YZ

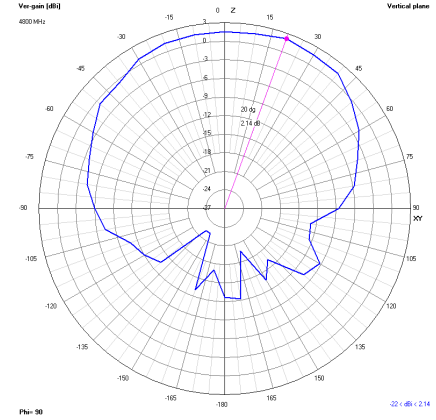

4900 MHz XY

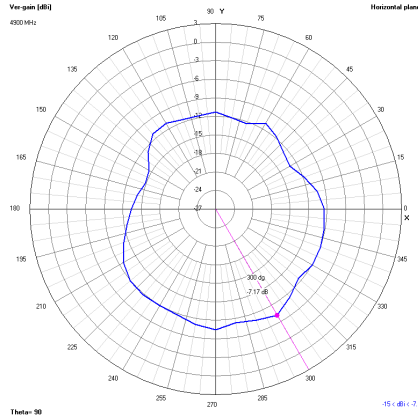

XZ

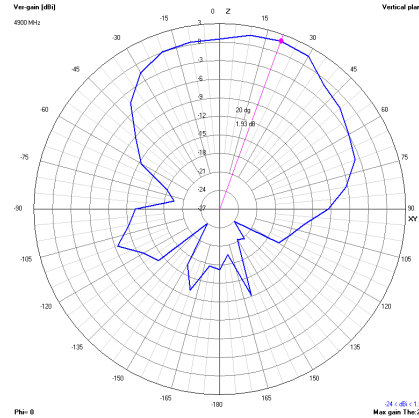

YZ

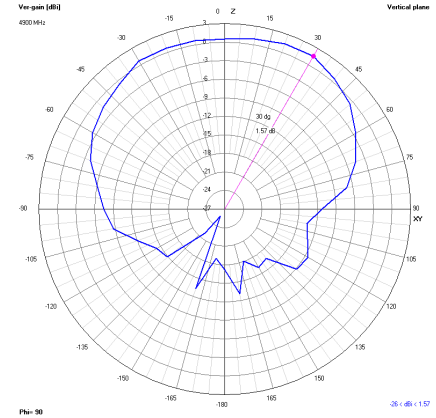

5000 MHz XY

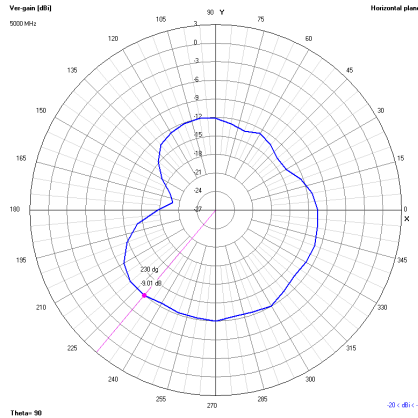

XZ

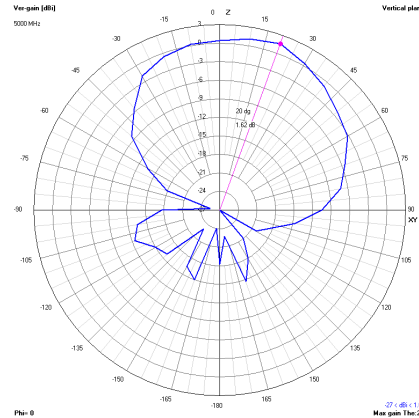

YZ

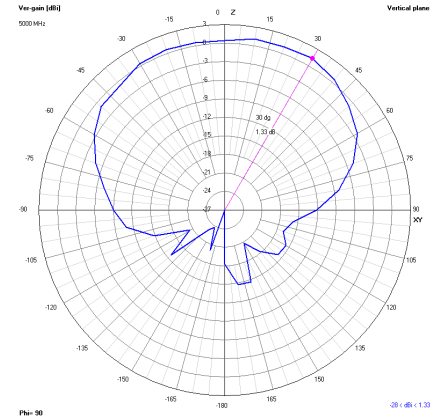



Tango 24

DUAL BAND WIFI 2.4/5.8 GHZ WITH LTE BANDS THROUGH HOLE MOUNT ANTENNA

Radiation Plots tested with 1 m cable

5100 MHz XY

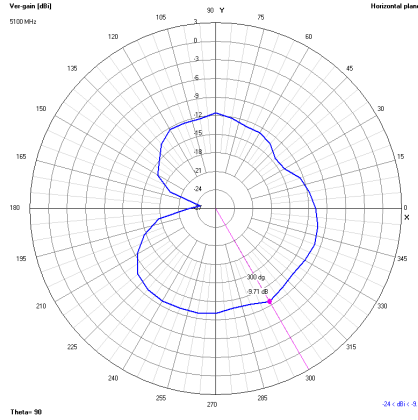

XZ

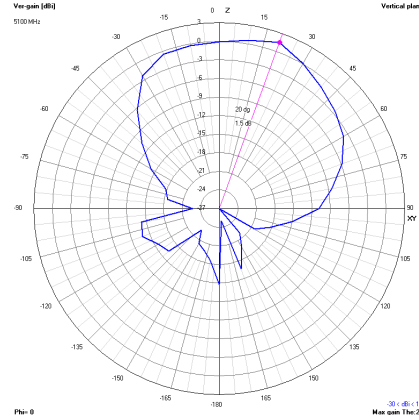

YZ

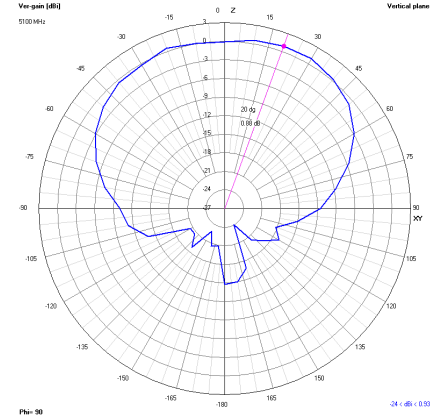

5200 MHz XY

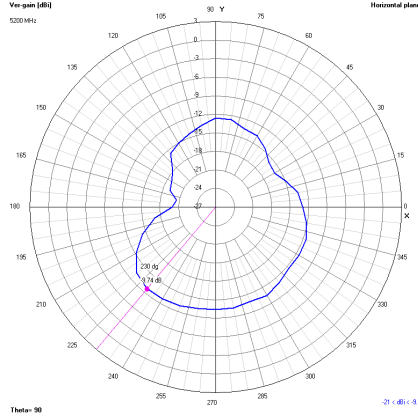

XZ

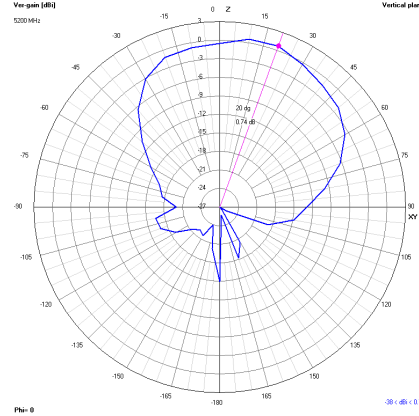

YZ

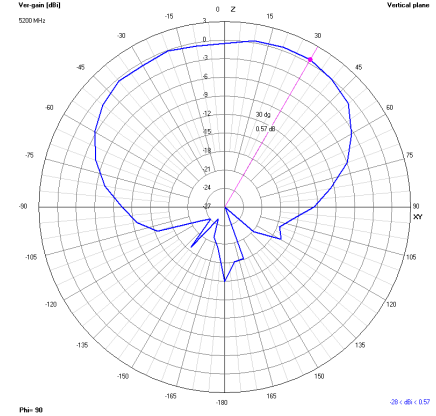

5300 MHz XY

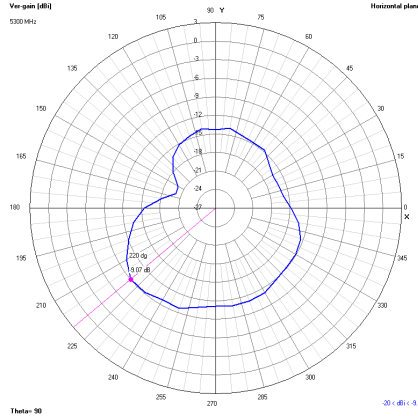

XZ

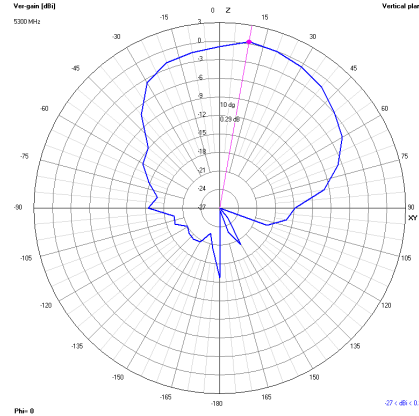

YZ

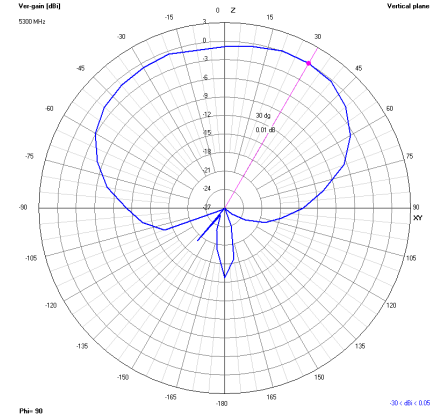



Tango 24

DUAL BAND WIFI 2.4/5.8 GHZ WITH LTE BANDS THROUGH HOLE MOUNT ANTENNA

Radiation Plots tested with 1 m cable

5400 MHz XY

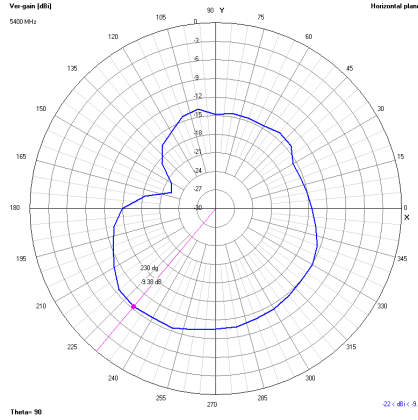

XZ

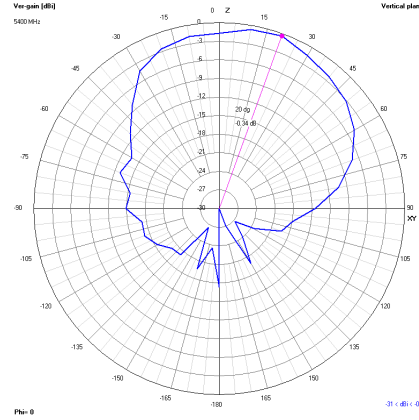

YZ

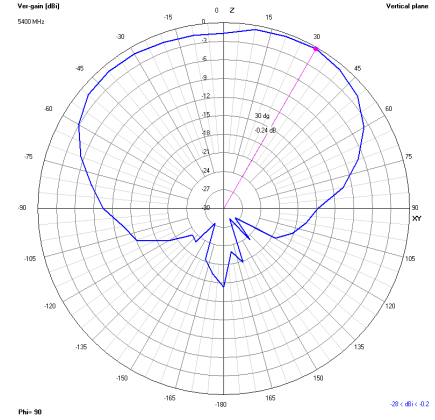

5500 MHz XY

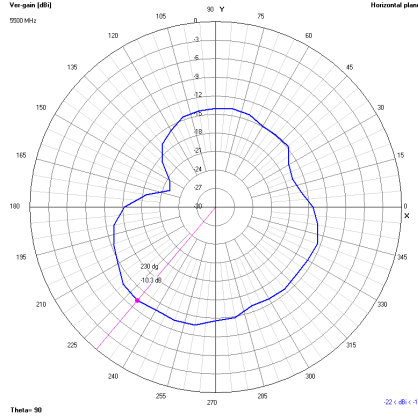

XZ

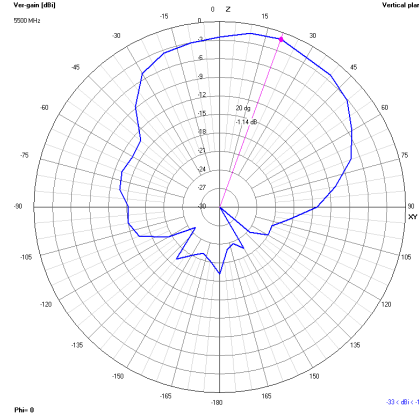

YZ

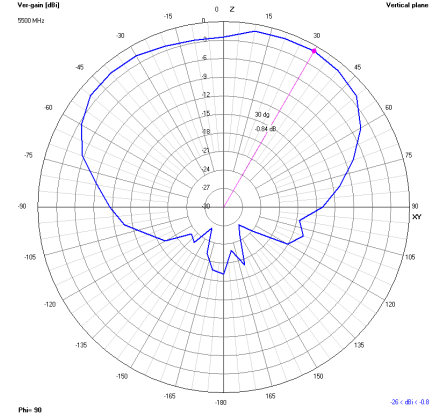

5600 MHz XY

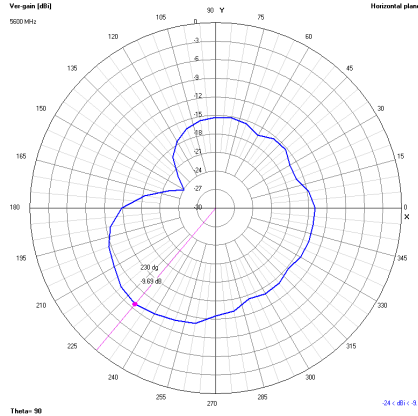

XZ

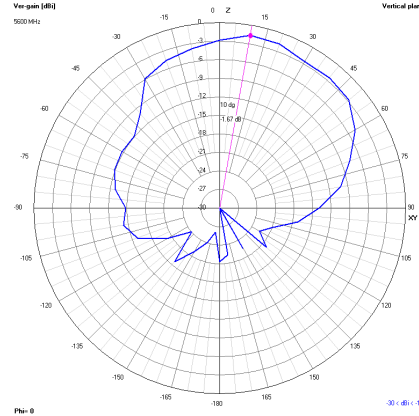

YZ

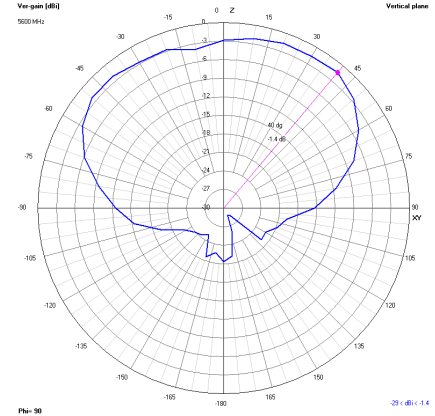



Tango 24

DUAL BAND WIFI 2.4/5.8 GHZ WITH LTE BANDS THROUGH HOLE MOUNT ANTENNA

Radiation Plots tested with 1 m cable

5700 MHz XY

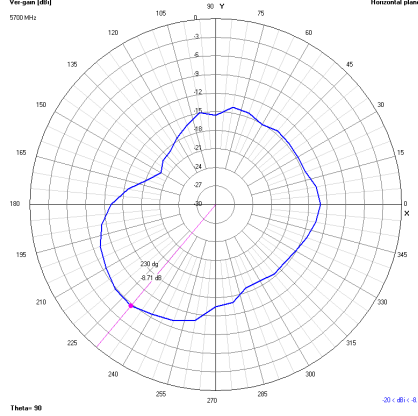

XZ

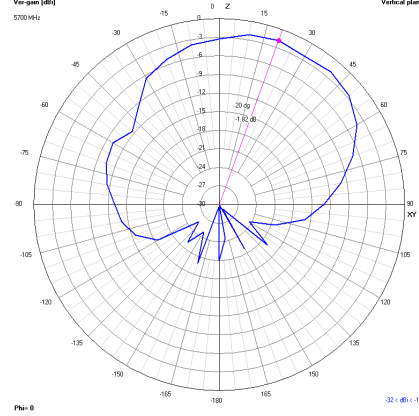

YZ

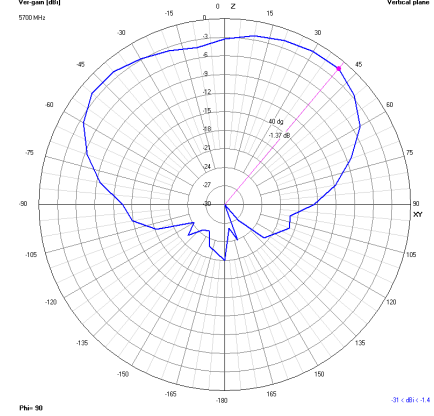

5800 MHz XY

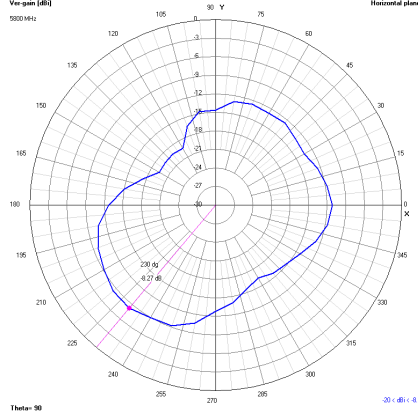

XZ

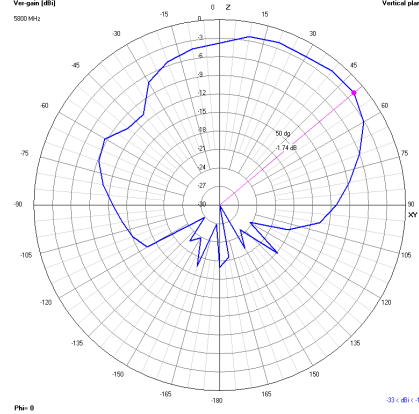

YZ

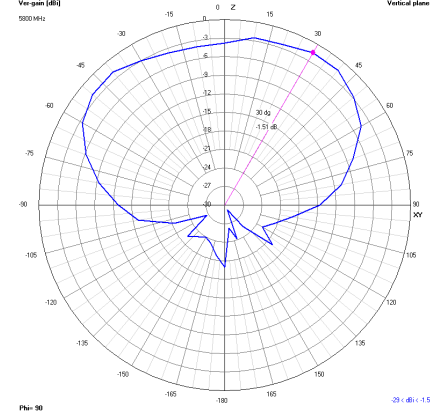

5900 MHz XY

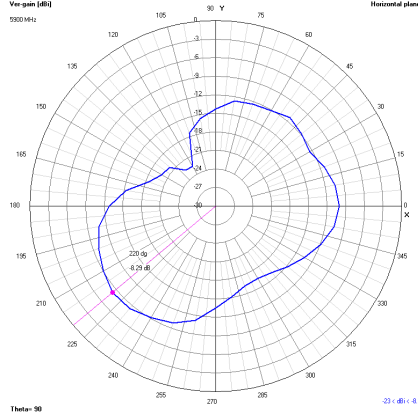

XZ

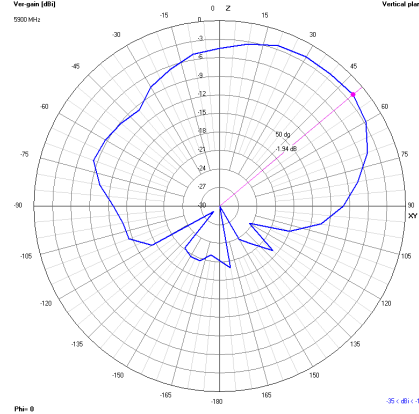

YZ

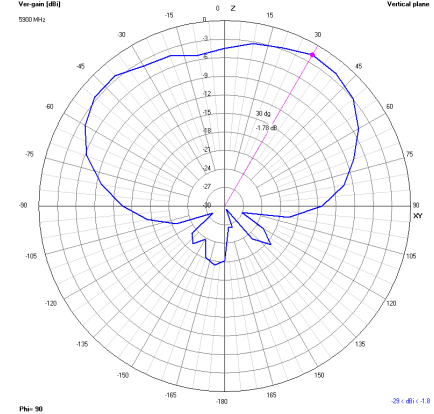



3D Radiation Plots tested with 1 m cable

1400 MHz

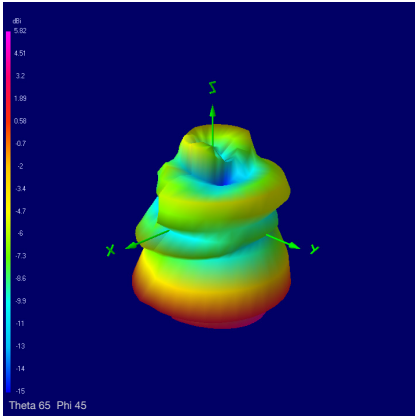

1500 MHz

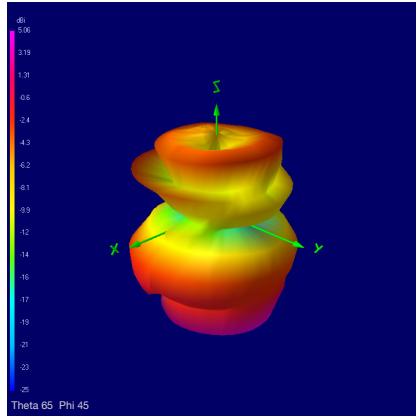

1600 MHz

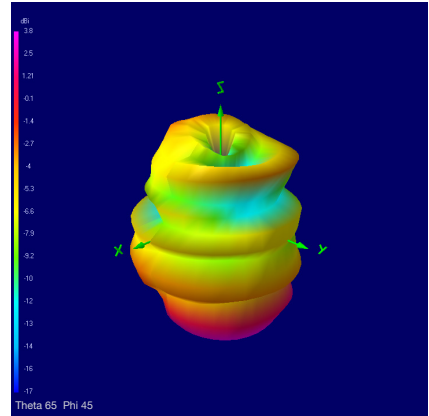

1700 MHz

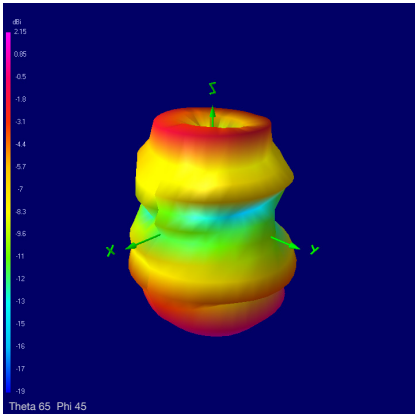

1800 MHz

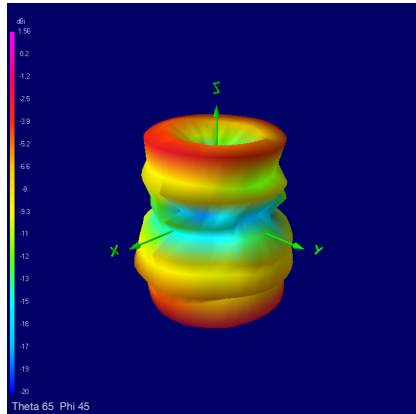

1900 MHz

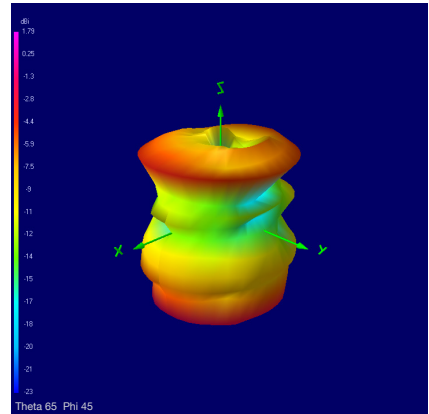

2000 MHz

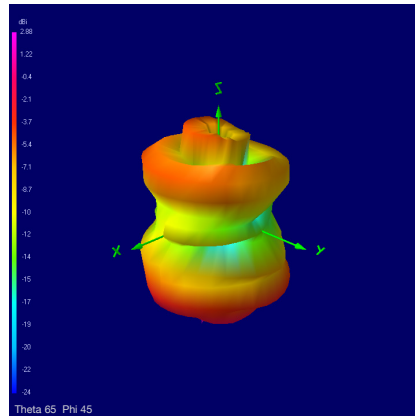

2100 MHz

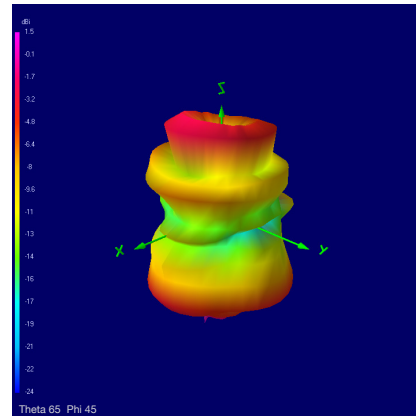

2200 MHz

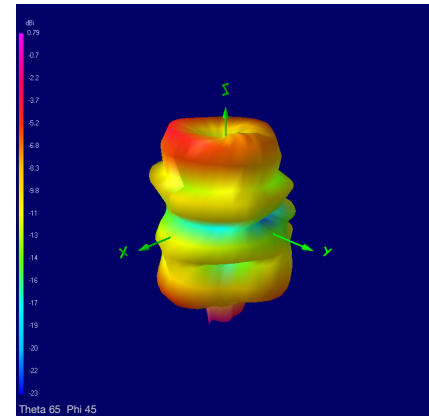



3D Radiation Plots tested with 1 m cable

2400 MHz

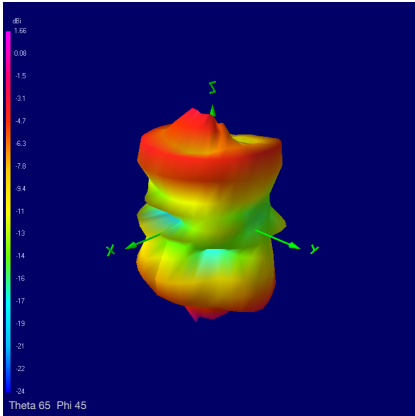

2500 MHz

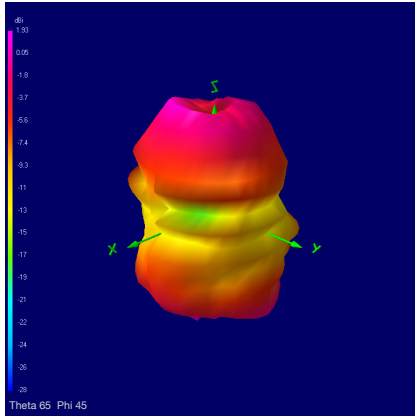

2600 MHz

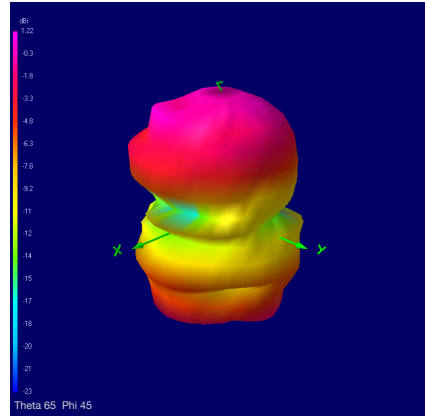

2700 MHz

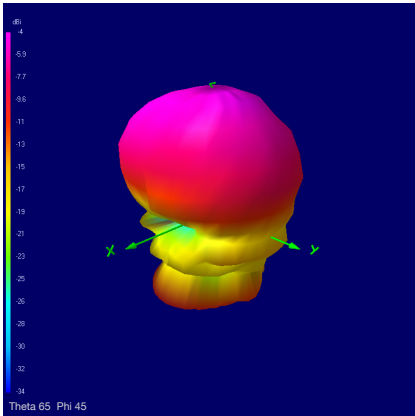

3500 MHz

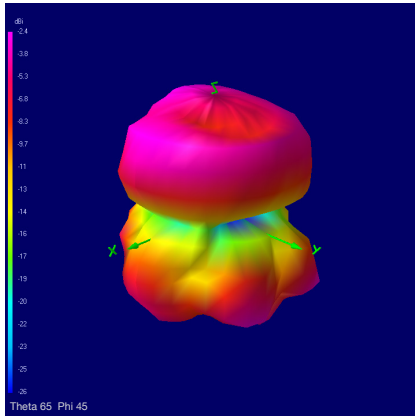

3600 MHz

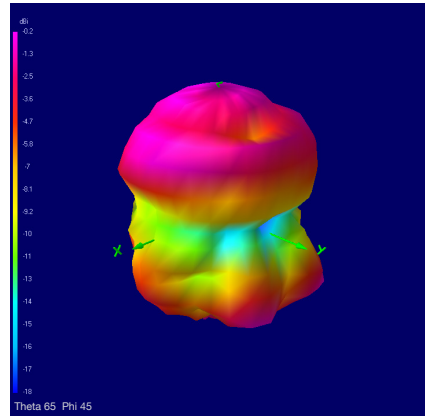

3700 MHz

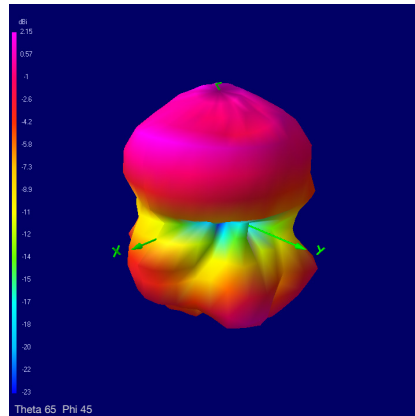

3800 MHz

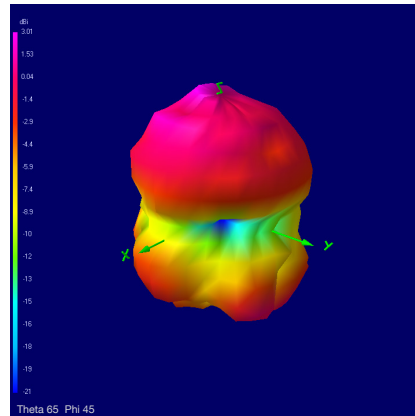

4400 MHz

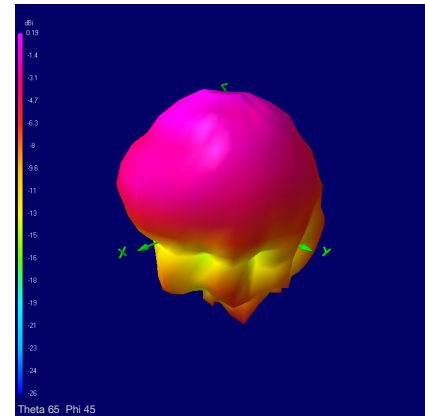



3D Radiation Plots tested with 1 m cable

4500 MHz

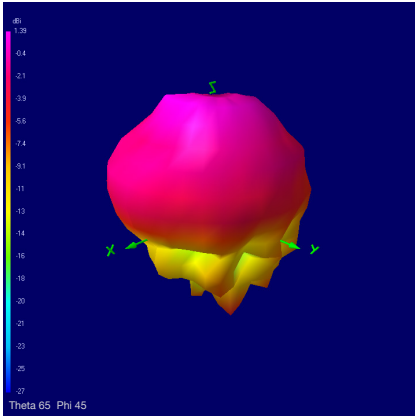

4600 MHz

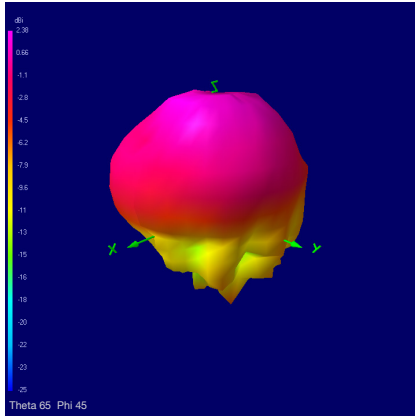

4700 MHz

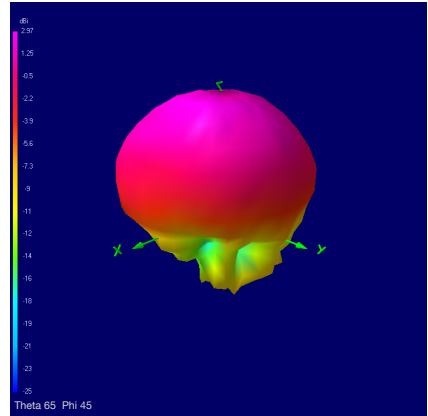

4800 MHz

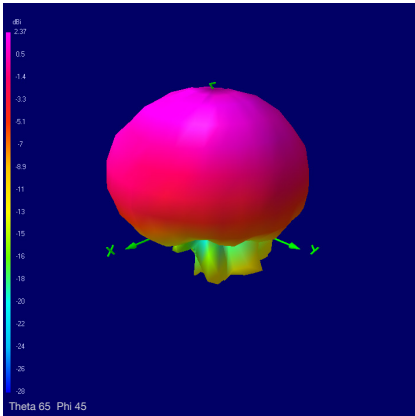

4900 MHz

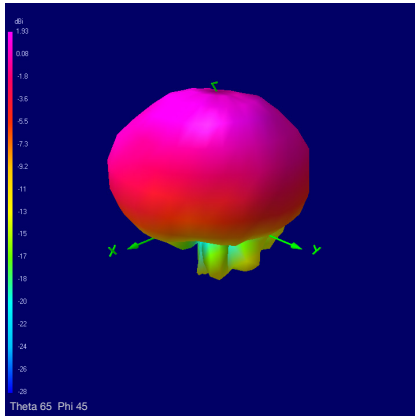

5000 MHz

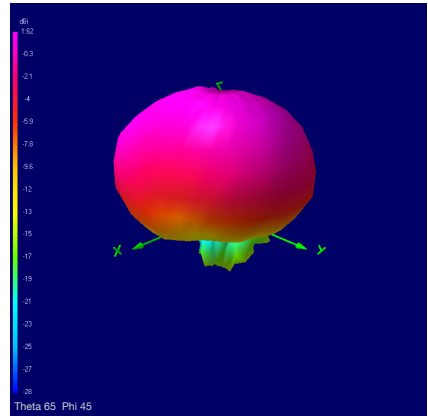

5100 MHz

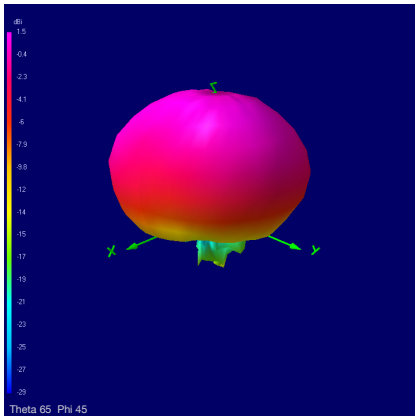

5200 MHz

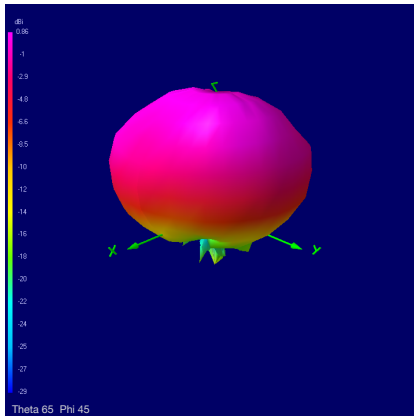

5300 MHz

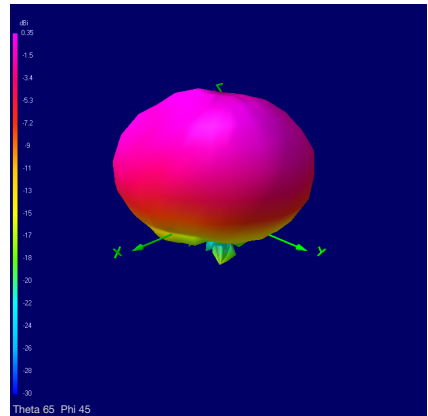



3D Radiation Plots tested with 1 m cable

5400 MHz

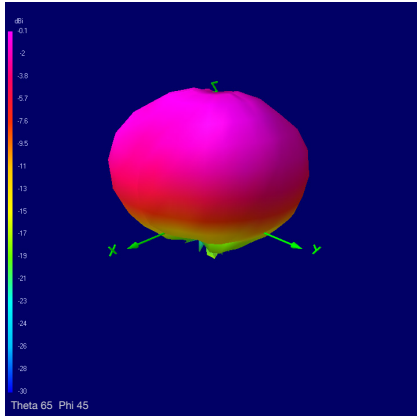

5500 MHz

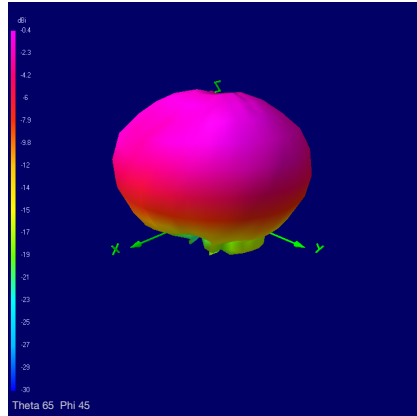

5600 MHz

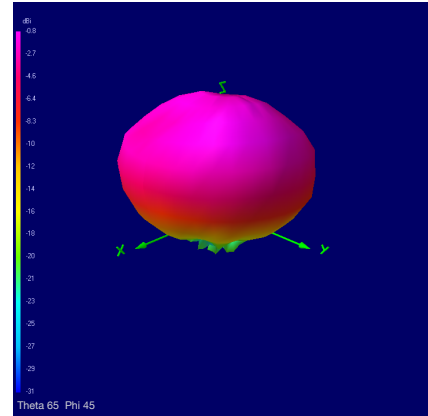

5700 MHz

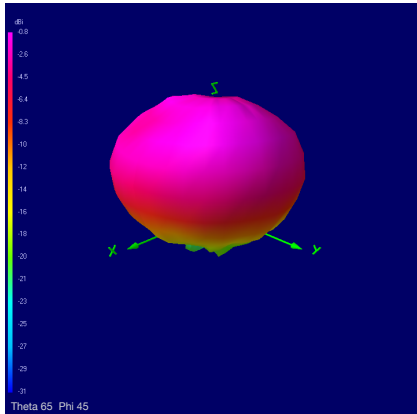

5800 MHz

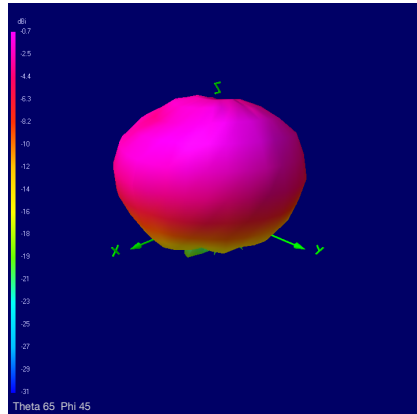

5900 MHz

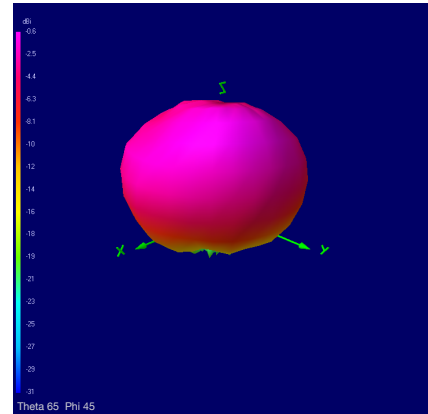

Ordering Details

Part Number	Description
TANGO24/1M/SMAM/S/RP/17	DUAL BAND WIFI 2.4/5.8 GHZ WITH LTE BANDS THROUGH HOLE MOUNT ANTENNA SMA MALE RP CONNECTOR 1M CABLE
TANGO24/2M/SMAM/S/RP/17	DUAL BAND WIFI 2.4/5.8 GHZ WITH LTE BANDS THROUGH HOLE MOUNT ANTENNA SMA MALE RP CONNECTOR 2M CABLE
TANGO24/2.5M/SMAM/S/RP/17	DUAL BAND WIFI 2.4/5.8 GHZ WITH LTE BANDS THROUGH HOLE MOUNT ANTENNA SMA MALE RP CONNECTOR 2.5M CABLE
TANGO24/1M/SMAM/S/S/17	DUAL BAND WIFI 2.4/5.8 GHZ WITH LTE BANDS THROUGH HOLE MOUNT ANTENNA SMA MALE CONNECTOR 1M CABLE
TANGO24/2M/SMAM/S/S/17	DUAL BAND WIFI 2.4/5.8 GHZ WITH LTE BANDS THROUGH HOLE MOUNT ANTENNA SMA MALE CONNECTOR 2M CABLE