

## Important notice

Dear Customer,

On 7 February 2017 the former NXP Standard Product business became a new company with the tradename **Nexperia**. Nexperia is an industry leading supplier of Discrete, Logic and PowerMOS semiconductors with its focus on the automotive, industrial, computing, consumer and wearable application markets

In data sheets and application notes which still contain NXP or Philips Semiconductors references, use the references to Nexperia, as shown below.

Instead of <http://www.nxp.com>, <http://www.philips.com/> or <http://www.semiconductors.philips.com/>, use <http://www.nexperia.com>

Instead of [sales.addresses@www.nxp.com](mailto:sales.addresses@www.nxp.com) or [sales.addresses@www.semiconductors.philips.com](mailto:sales.addresses@www.semiconductors.philips.com), use [salesaddresses@nexperia.com](mailto:salesaddresses@nexperia.com) (email)

Replace the copyright notice at the bottom of each page or elsewhere in the document, depending on the version, as shown below:

- © NXP N.V. (year). All rights reserved or © Koninklijke Philips Electronics N.V. (year). All rights reserved

Should be replaced with:

- © **Nexperia B.V. (year). All rights reserved.**

If you have any questions related to the data sheet, please contact our nearest sales office via e-mail or telephone (details via [salesaddresses@nexperia.com](mailto:salesaddresses@nexperia.com)). Thank you for your cooperation and understanding,

Kind regards,

Team Nexperia

# DATA SHEET

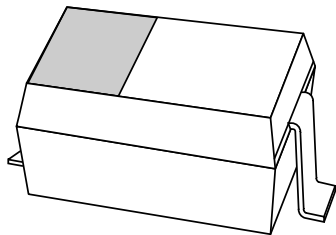

## **PMEG2020AEA**

20 V, 2 A very low  $V_F$  MEGA  
Schottky barrier rectifier in SOD323  
(SC-76) package

# 20 V, 2 A very low $V_F$ MEGA Schottky barrier rectifier in SOD323 (SC-76) package

**PMEG2020AEA**

## FEATURES

- Forward current: 2 A
- Reverse voltage: 20 V
- Very low forward voltage
- Very small SMD package.

## APPLICATIONS

- Low voltage rectification
- High efficiency DC/DC conversion
- Switch mode power supply
- Inverse polarity protection
- Low power consumption applications.

## DESCRIPTION

Planar Maximum Efficiency General Application (MEGA) Schottky barrier rectifier with an integrated guard ring for stress protection, encapsulated in a SOD323 (SC-76) very small SMD plastic package.

## MARKING

TYPE NUMBER	MARKING CODE
PMEG2020AEA	S3

## QUICK REFERENCE DATA

SYMBOL	PARAMETER	VALUE	UNIT
$I_F$	forward current	2	A
$V_R$	reverse voltage	20	V

## PINNING

PIN	DESCRIPTION
1	cathode
2	anode

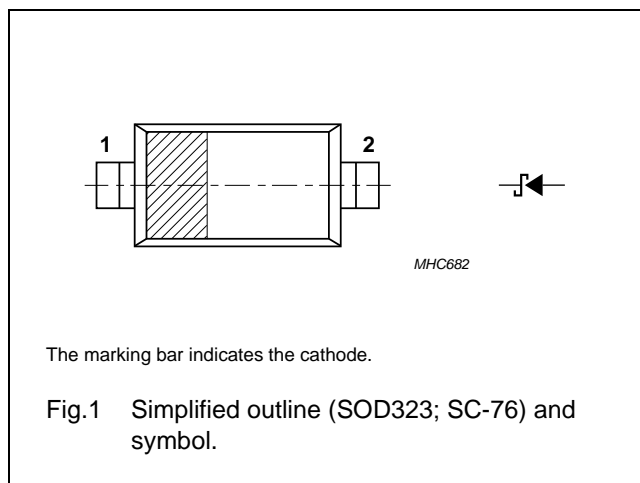

## RELATED PRODUCTS

TYPE NUMBER	DESCRIPTION	FEATURES
PMEG1020EA	2 A; 10 V ultra low $V_F$ MEGA Schottky barrier rectifier	SOD323 package; lower reverse voltage; lower forward voltage
PMEG2010EA	1 A; 20 V ultra low $V_F$ MEGA Schottky barrier rectifier	SOD323 package; lower forward current; lower reverse current and diode capacitance

## ORDERING INFORMATION

TYPE NUMBER	PACKAGE		
	NAME	DESCRIPTION	VERSION
PMEG2020AEA	-	plastic surface mounted package; 2 leads	SOD323

# 20 V, 2 A very low $V_F$ MEGA Schottky barrier rectifier in SOD323 (SC-76) package

PMEG2020AEA

## LIMITING VALUES

In accordance with the Absolute Maximum Rating System (IEC 60134)

SYMBOL	PARAMETER	CONDITIONS	MIN.	MAX.	UNIT
$V_R$	continuous reverse voltage		–	20	V
$I_F$	continuous forward current	$T_{sp} \leq 55\text{ °C}$	–	2	A
$I_{FRM}$	repetitive peak forward current	$t_p \leq 1\text{ ms}$ ; $\delta \leq 0.25$	–	7	A
$I_{FSM}$	non-repetitive peak forward current	$t = 8\text{ ms square wave}$	–	9	A
$T_{stg}$	storage temperature		–65	+150	°C
$T_j$	junction temperature		–	150	°C
$T_{amb}$	operating ambient temperature		–65	+150	°C

## THERMAL CHARACTERISTICS

SYMBOL	PARAMETER	CONDITIONS	VALUE	UNIT
$R_{th(j-a)}$	thermal resistance from junction to ambient	notes 1 and 2	450	K/W
$R_{th(j-a)}$	thermal resistance from junction to ambient	notes 2 and 3	210	K/W
$R_{th(j-s)}$	thermal resistance from junction to solder point	note 4	90	K/W

### Notes

1. Refer to SOD323 (SC-76) standard mounting conditions.
2. For Schottky barrier diodes thermal runaway has to be considered, as in some applications, the reverse power losses  $P_R$  are a significant part of the total power losses. Nomograms for determination of the reverse power losses  $P_R$  and  $I_F$  (AV) rating will be available on request.
3. Device mounted on a on an FR4 printed-circuit board with copper clad 10 x 10 mm.
4. Soldering point of cathode tab.

## ELECTRICAL CHARACTERISTICS

$T_j = 25\text{ °C}$  unless otherwise specified.

SYMBOL	PARAMETER	CONDITIONS	TYP.	MAX.	UNIT
$V_F$	forward voltage	see Fig.2; note 1			
		$I_F = 0.01\text{ A}$	200	220	mV
		$I_F = 0.1\text{ A}$	265	290	mV
		$I_F = 1\text{ A}$	380	430	mV
$I_R$	reverse current	$V_R = 5\text{ V}$ ; see Fig.3	15	50	$\mu\text{A}$
		$V_R = 10\text{ V}$	20	80	$\mu\text{A}$
		$V_R = 20\text{ V}$	50	200	$\mu\text{A}$
$C_d$	diode capacitance	$V_R = 5\text{ V}$ ; $f = 1\text{ MHz}$ ; see Fig.4	55	70	pF

### Note

1. Pulse test:  $t_p \leq 300\text{ }\mu\text{s}$ ;  $\delta \leq 0.02$ .

20 V, 2 A very low  $V_F$  MEGA Schottky barrier rectifier in SOD323 (SC-76) package

PMEG2020AEA

GRAPHICAL DATA

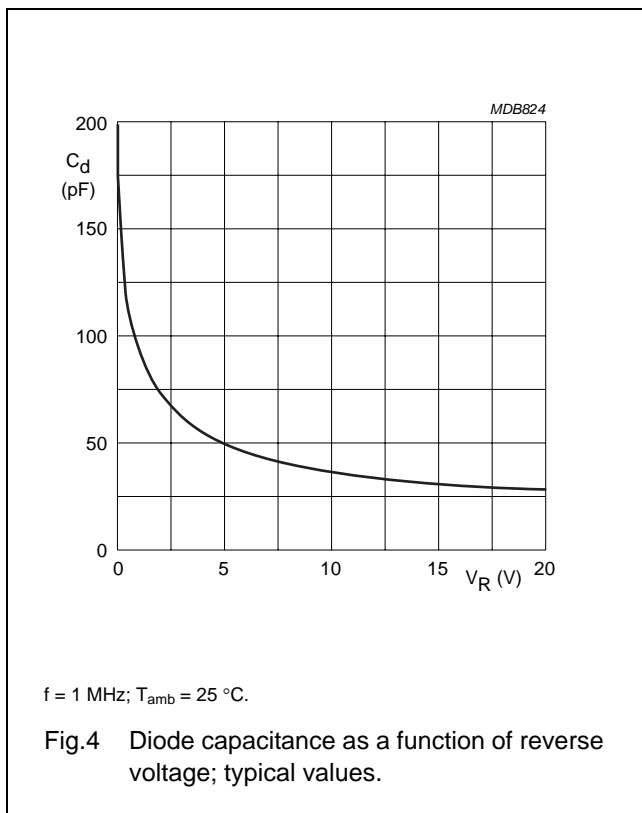
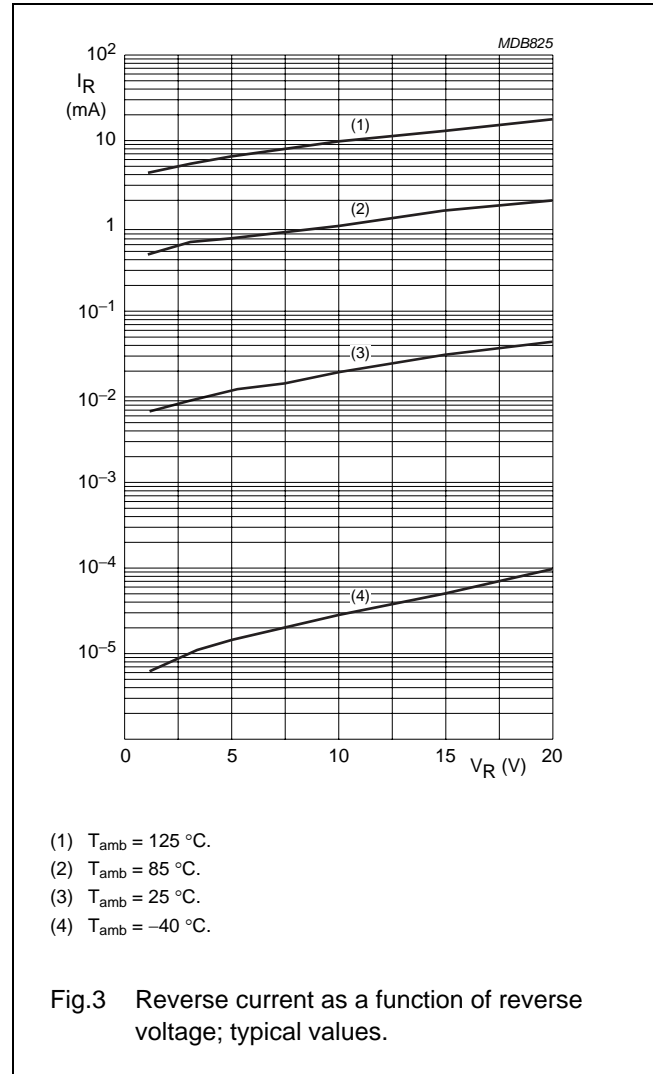
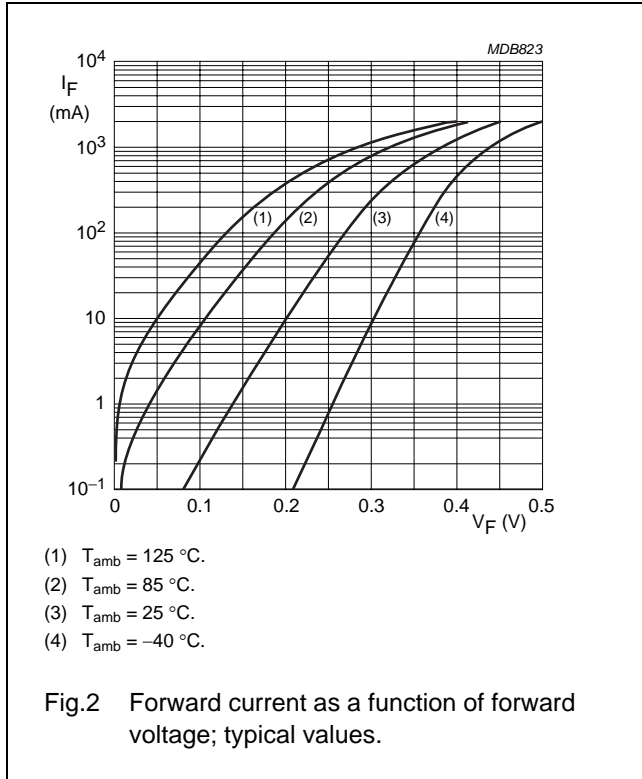

20 V, 2 A very low  $V_F$  MEGA Schottky barrier rectifier in SOD323 (SC-76) package

PMEG2020AEA

PACKAGE OUTLINE

Plastic surface-mounted package; 2 leads

SOD323

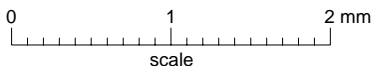
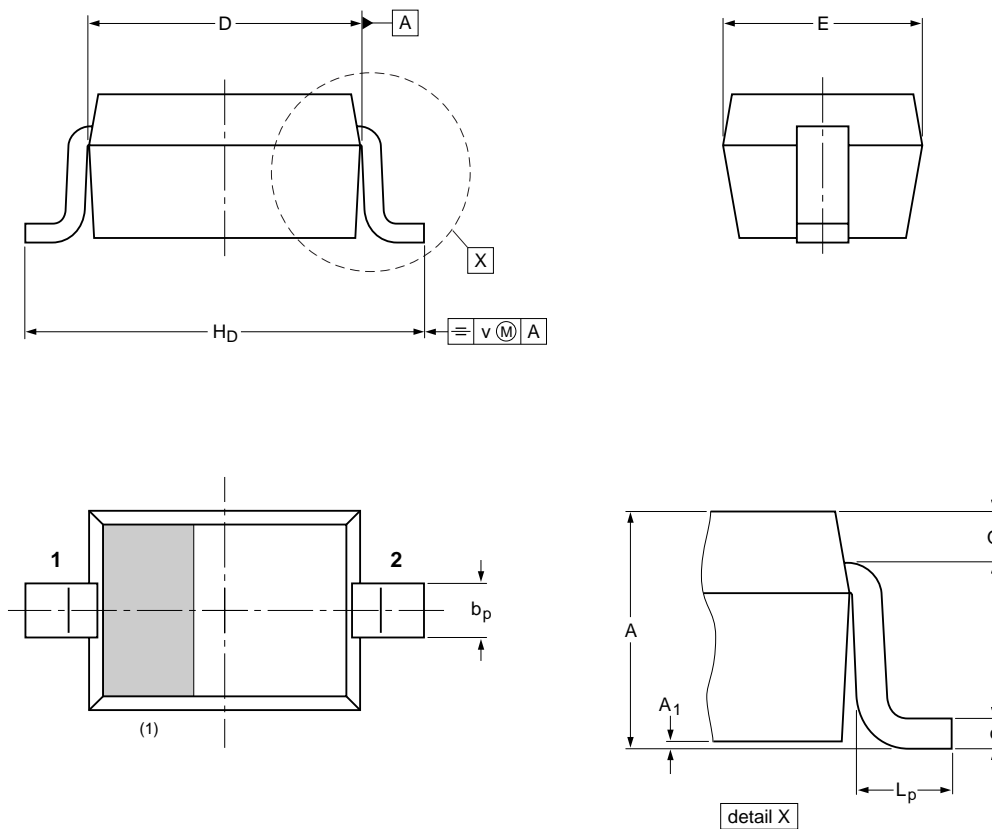

DIMENSIONS (mm are the original dimensions)

UNIT	A	A <sub>1</sub> max	b <sub>p</sub>	c	D	E	H <sub>D</sub>	L <sub>p</sub>	Q	v
mm	1.1 0.8	0.05	0.40 0.25	0.25 0.10	1.8 1.6	1.35 1.15	2.7 2.3	0.45 0.15	0.25 0.15	0.2

Note

1. The marking bar indicates the cathode

OUTLINE VERSION	REFERENCES			EUROPEAN PROJECTION	ISSUE DATE
	IEC	JEDEC	JEITA		
SOD323			SC-76		<del>03-12-17</del> 06-03-16

# 20 V, 2 A very low $V_F$ MEGA Schottky barrier rectifier in SOD323 (SC-76) package

PMEG2020AEA

## DATA SHEET STATUS

DOCUMENT STATUS <sup>(1)</sup>	PRODUCT STATUS <sup>(2)</sup>	DEFINITION
Objective data sheet	Development	This document contains data from the objective specification for product development.
Preliminary data sheet	Qualification	This document contains data from the preliminary specification.
Product data sheet	Production	This document contains the product specification.

## Notes

1. Please consult the most recently issued document before initiating or completing a design.
2. The product status of device(s) described in this document may have changed since this document was published and may differ in case of multiple devices. The latest product status information is available on the Internet at URL <http://www.nxp.com>.

## DISCLAIMERS

**General** — Information in this document is believed to be accurate and reliable. However, NXP Semiconductors does not give any representations or warranties, expressed or implied, as to the accuracy or completeness of such information and shall have no liability for the consequences of use of such information.

**Right to make changes** — NXP Semiconductors reserves the right to make changes to information published in this document, including without limitation specifications and product descriptions, at any time and without notice. This document supersedes and replaces all information supplied prior to the publication hereof.

**Suitability for use** — NXP Semiconductors products are not designed, authorized or warranted to be suitable for use in medical, military, aircraft, space or life support equipment, nor in applications where failure or malfunction of an NXP Semiconductors product can reasonably be expected to result in personal injury, death or severe property or environmental damage. NXP Semiconductors accepts no liability for inclusion and/or use of NXP Semiconductors products in such equipment or applications and therefore such inclusion and/or use is at the customer's own risk.

**Applications** — Applications that are described herein for any of these products are for illustrative purposes only. NXP Semiconductors makes no representation or warranty that such applications will be suitable for the specified use without further testing or modification.

**Limiting values** — Stress above one or more limiting values (as defined in the Absolute Maximum Ratings System of IEC 60134) may cause permanent damage to the device. Limiting values are stress ratings only and operation of the device at these or any other conditions above those given in the Characteristics sections of this document is not implied. Exposure to limiting values for extended periods may affect device reliability.

**Terms and conditions of sale** — NXP Semiconductors products are sold subject to the general terms and conditions of commercial sale, as published at <http://www.nxp.com/profile/terms>, including those pertaining to warranty, intellectual property rights infringement and limitation of liability, unless explicitly otherwise agreed to in writing by NXP Semiconductors. In case of any inconsistency or conflict between information in this document and such terms and conditions, the latter will prevail.

**No offer to sell or license** — Nothing in this document may be interpreted or construed as an offer to sell products that is open for acceptance or the grant, conveyance or implication of any license under any copyrights, patents or other industrial or intellectual property rights.

**Export control** — This document as well as the item(s) described herein may be subject to export control regulations. Export might require a prior authorization from national authorities.

**Quick reference data** — The Quick reference data is an extract of the product data given in the Limiting values and Characteristics sections of this document, and as such is not complete, exhaustive or legally binding.

# ***NXP Semiconductors***

## **Customer notification**

This data sheet was changed to reflect the new company name NXP Semiconductors, including new legal definitions and disclaimers. No changes were made to the technical content, except for package outline drawings which were updated to the latest version.

## **Contact information**

For additional information please visit: <http://www.nxp.com>

For sales offices addresses send e-mail to: [salesaddresses@nxp.com](mailto:salesaddresses@nxp.com)

© NXP B.V. 2009

All rights are reserved. Reproduction in whole or in part is prohibited without the prior written consent of the copyright owner.

The information presented in this document does not form part of any quotation or contract, is believed to be accurate and reliable and may be changed without notice. No liability will be accepted by the publisher for any consequence of its use. Publication thereof does not convey nor imply any license under patent- or other industrial or intellectual property rights.

Printed in The Netherlands

R76/01/pp7

Date of release: 2004 Feb 26

Document order number: 9397 750 11976

