

Disinfection Module Solution

Specification

XMD-FBC-LLVA



Product Brief

Description

- This module is designed for disinfection.

Features and Benefits

- Lead free product
- Push-in connectors
- Can be used in daisy chain configuration
- UL Compliant: E518993
- CE Tested to Standards:
 - EN55105 : 2013
 - EN61547 : 2009
 - EN62031 : 2008 + A1: 2013 + A2: 2015
 - EN62741 : 2008

Key Applications

- Horticulture
- Reptile lighting
- Surface disinfection
- Fluorescent spectroscopy
- Chemical and biological analysis

Table 1. Product

Model	Input Current[I_f]	Φ_e [mW]	W_p [nm]			Remark
			MIN	TYP	MAX	
XMD-FBC-LLVA	1.8A	828	270	275	280	Constant Current

Table of Contents

Index	
• Product Brief	
• Table of Contents	
• Performance Characteristics	
• Drawing	
• Wire Guide	
• Packing	
• Label Information	
• Precaution for Use	

Performance Characteristics

Table 2. Electro Optical Characteristics at 1.8A(Constant Current)

($T_a=25^{\circ}\text{C}$ RH=30%)

Parameter	Symbol	Value			Unit
		Min.	Typ.	Max.	
Peak wavelength ^[1]	λ_p	270	275	280	nm
Forward Voltage	V_F	20	24	27	V
Power Consumption	P	36	43.2	48.6	W
Radiant Flux ^[2]	Φ_e ^[3]	648	828	-	mW

Notes :

[1] P_d can be changed by surrounding temperature and current.

[2] Peak Wavelength Measurement tolerance : $\pm 3\text{nm}$

[3] Radiant Flux Measurement tolerance : $\pm 10\%$

[4] Φ_e is the Total Radiant Flux as measured with an integrated sphere.

[5] Forward Voltage Measurement tolerance : $\pm 3\%$

※Operating temperature was tested at the assigned T_c point on the PCB.

※It is recommended to drive under conditions of $T_c= 60^{\circ}\text{C}$ or less.

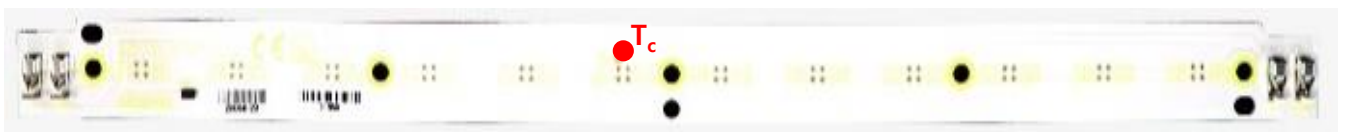
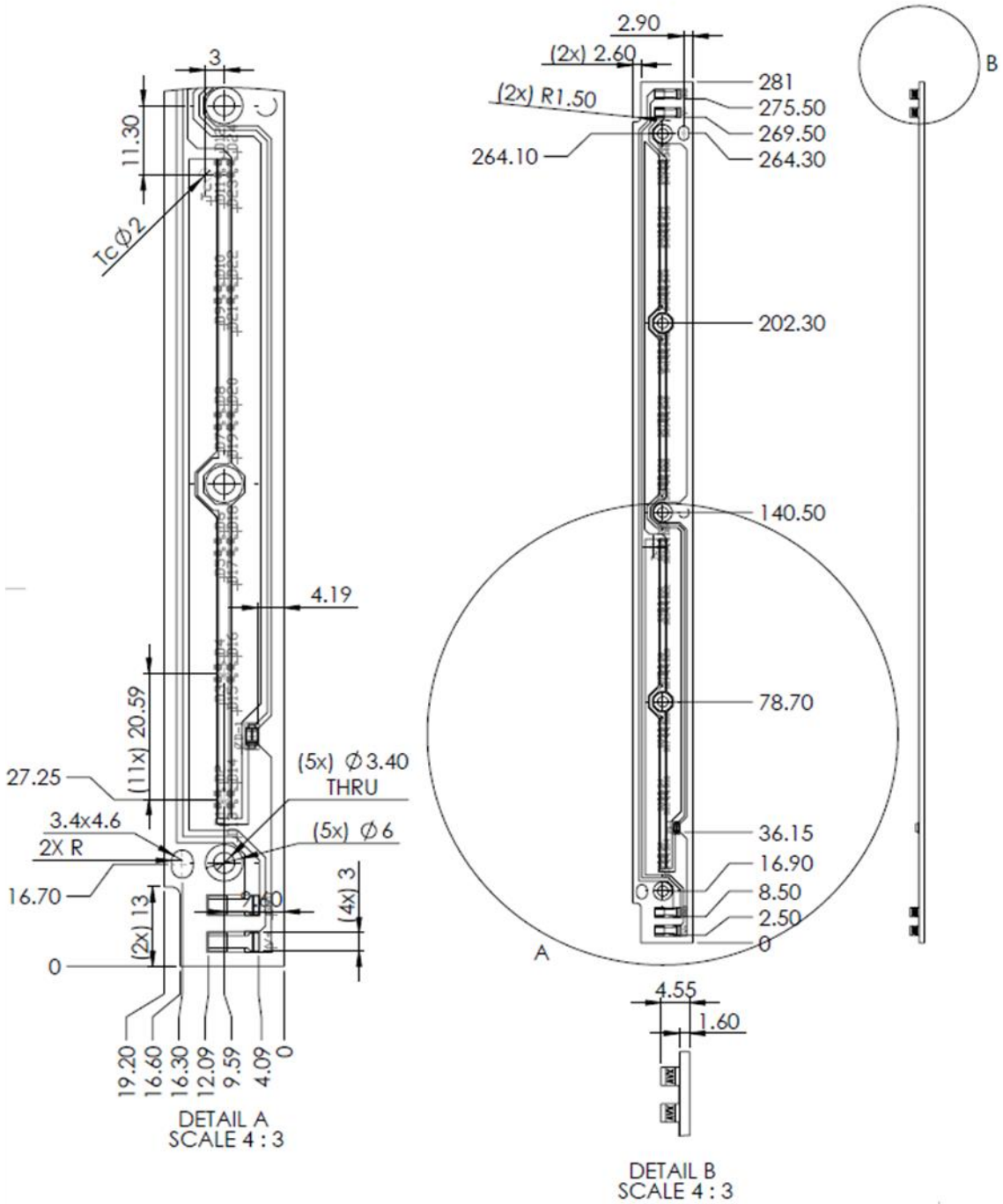

Table 3. Absolute Maximum Ratings

Parameter	Symbol	Unit	Value
Operating Temperature	T_{opr}	$^{\circ}\text{C}$	-20 ~ +40
Storage Temperature	T_{stg}	$^{\circ}\text{C}$	-20 ~ +60

Drawing



- (1) All dimensions are in mm
- (2) For reference only
- (3) Not to scale

For 4 LED clusters – clusters on centerline
 For 2 LED clusters – All LEDs on centerline
 For 1 LED clusters – LED at cluster center
 Recommended fasteners: M3 pan head

Notes :

- Module Dimensions of the indicated maximum value, and to allow a tolerance : ± 0.5 [mm]

Wire Guide

WARNING: DO NOT WIRE MORE THAN 9 BOARDS IN SERIES

Notes:

- Tool to open the contact to Insert/withdraw wire.
Contact opening tool [P/N : 06-9296-7001-01-000]
- Wire Size : 18AWG to 26AWG [solid/stranded copper conductor.]
- Wire Trim Length : $4.5 \pm 0.5\text{mm}$ [AVX Connector]

Single Board



For terminating end:
V- to GND

Multiple Boards



For all junctions:
V- to V+
GND to GND

For terminating end:
V- to GND

Packing

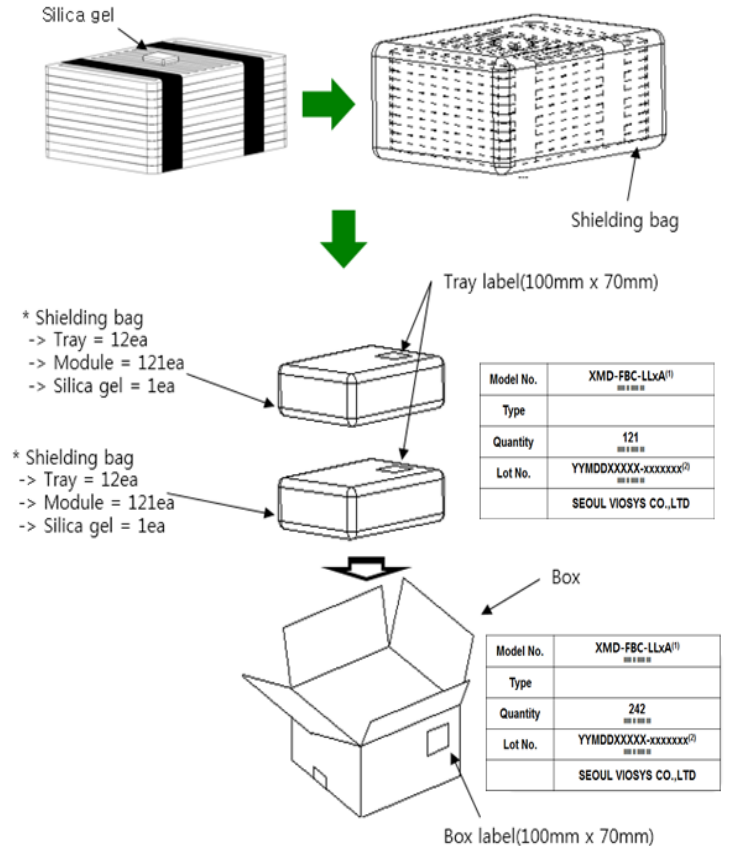
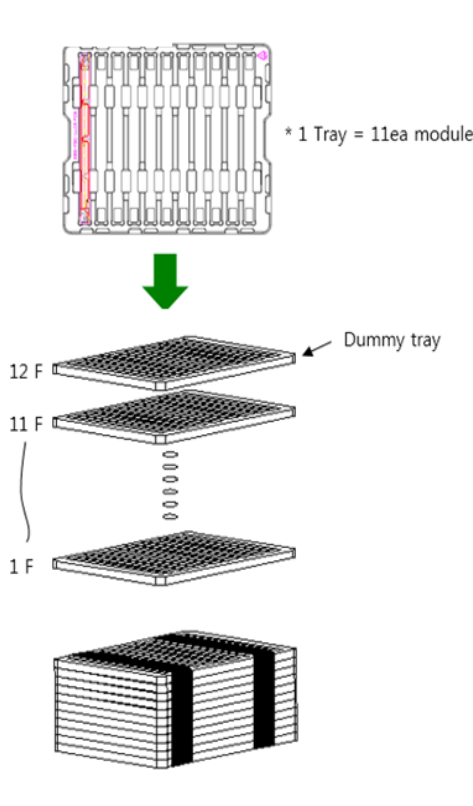

Part	Index	Unit	XMD-FBC-LLCA	Remark
Tray	Size	mm	380 X 315 X 14	
	Module Quantity	ea	11	
	Weight	kg	0.17	Without LED Module
		Kg	0.44	With LED module
BOX	Size	mm	407 X 333 X 280	
	Tray Quantity	Ea	22(+2Dummy)	
	Module Quantity	ea	242	
	Material	-	Anti-static PET	
	Weight	kg	10.5	With LED module
Pallet	Size	mm	1100(L) X 1100(W)	
	Box quantity	ea	32	8 Box X 4 Layer
	Weight	kg	5	Only Pallet
Total	Module quantity	ea	7,744	
	Weight	kg	350	With LED module

Label Information

Fig 1. Marking point

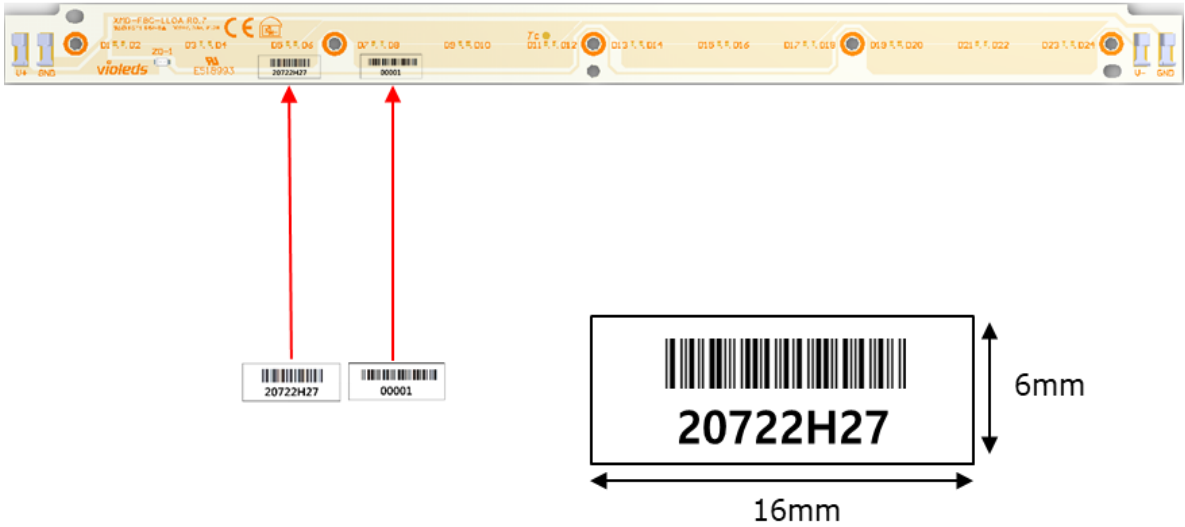
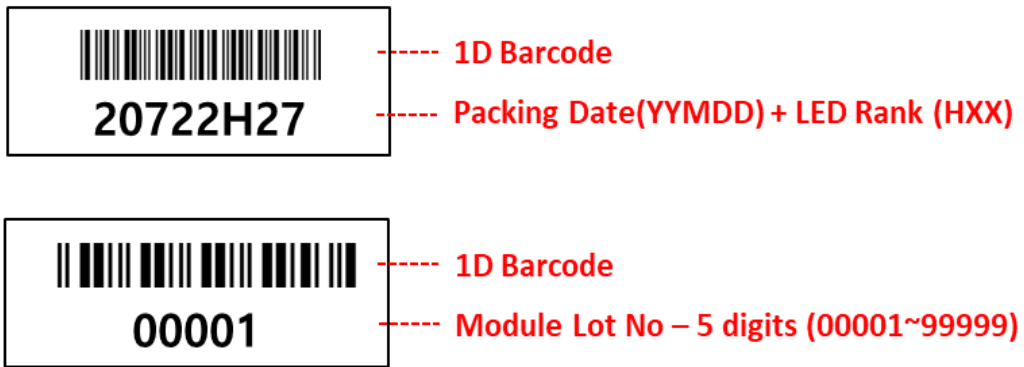



Fig 2. Marking information



Notes

- 1) Refer to the page 11 for Packing Date

Label Information

Model No.	XMD-FBC-LLVA⁽¹⁾
Type	
Quantity	XXX
Lot No.	YYMDDXXXXX-xxxxxxx⁽²⁾
	SEOUL VIOSYS CO.,LTD

Reference

- (1) It represent module part number.
- (2) YYMDD : Packing Date
 YY : last 2digits of year(ex – 2018 → 18)
 M : Oct-A, Nov-B, Dec-C(1digits)
 DD : Date(2digits)
 X : Initial of Manufacturer(1digits)
 XXXX : Sealing Pack No(4digits)
 - : dash
 XXXXXXX : SSC Code(7digits)

Note

- (1) It is attached to the top right corner of the box.

* Labeling

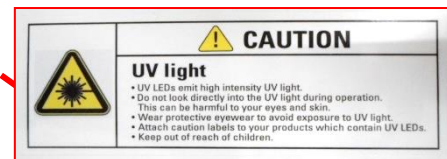
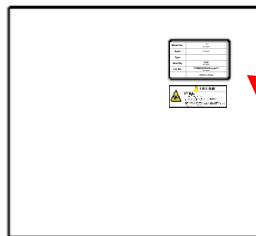

Precaution for Use

1) Storage

- To avoid moisture penetration, we recommend storing UV-Module in a dry box with a desiccant. The recommended temperature and Relative humidity are between 5°C and 30°C and below 50% respectively.
- UV-Module must be stored properly to maintain the device. If the UV-Module is stored for 3 months or more after being shipped from SVC, a sealed container with a nitrogen atmosphere should be used for storage.
- Replace the remained UV-Module into the moisture-proof bag and reseal the bag after work to avoid those UV-Module being exposed to moisture. Prolonged exposure to moisture can adversely affect the proper functioning of the UV-Module.

2) Handling Precautions

- VOCs (Volatile organic compounds) emitted from materials used in the construction of fixtures can penetrate products and discolor them when exposed to heat and photonic energy. The result can be a significant loss of light output from the fixture. Knowledge of the properties of the materials selected to be used in the construction of fixtures can help prevent these issues.
- In case of attaching UV-Module, do not use adhesives that outgas organic vapor.
- Please do not use(or storage) together with the materials containing Sulfur.
- Do not use inflammable material nearby the products.
- Do not touch the products with wet hand
- Do not fix or remodel the products.
- Do not drop the machine, or give strong impact on the products.
- The UV-Module is encapsulated with special material for the highest flux efficiency. So it needs to be handled carefully as below
 - Avoid touching quartz glass parts especially with sharp tools such as Tweezers
 - Avoid leaving fingerprints cover parts.
 - UV-Module will attract dust so use covered containers for storage.
 - It is not recommend to cover the UV-Module with other materials (epoxy, urethane, etc)

3) Safety for eyes and skin

- The Products emit high intensity ultraviolet light which can make your eyes and skin harmful, So do not look directly into the UV light and wear protective equipment during operation.



4) Cleaning

- After assembly the product, empty the water and then wipe the UV-Module with a dry towel.

Precaution for Use

5) Others

- Be sure to turn On / Off after module is connected.
When connecting the module in the power on state, LED can be damaged by the influence of the inrush voltage / current.
- The driving circuit must be designed to allow forward voltage or current only when it is ON or OFF . If the reverse voltage is applied to UV-Module, migration can be generated resulting in LED damage.
- Do not handle this product with acid or sulfur material in sealed space
- Please handle using equipment that prevents static electricity.
- Do not touch unless ESD protection is used.
- Ionizer, grounding and keeping appropriate humidity are necessary for work environment.
- The appearance and specifications of the product may be modified for improvement without notice

	 CAUTION
	<ul style="list-style-type: none"> •UV LEDs emit high intensity UV light. •Do not look directly into the UV light during operation. This can be harmful to your eyes and skin. •Wear protective eyewear to avoid exposure to UV light. •Attach caution labels to your products which contain UV LEDs. <p style="text-align: center;">Avoid direct eye and skin exposure to UV light. Keep out of reach of children.</p>