



Glass Passivated Three Phase Rectifier Bridge

VRRM 800 to 1800V
ID 160 A

Applications

- Three phase rectifiers for power supplies
- Rectifiers for DC motor field supplies
- Battery charger rectifiers
- Input rectifiers for variable frequency drives

Features

- Three phase bridge rectifier
- Blocking voltage:800 to 1800V
- Heat transfer through aluminum oxide DBC ceramic isolated metal baseplate
- Glass passivated chip
- UL recognized applied for file no. E360040

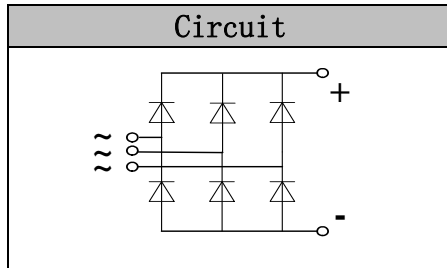

Module Type

| TYPE | VRRM | VRSM |
|------------|-------|-------|
| MD160S08M5 | 800V | 900V |
| MD160S12M5 | 1200V | 1300V |
| MD160S16M5 | 1600V | 1700V |
| MD160S18M5 | 1800V | 1900V |

Maximum Ratings

| Symbol | Conditions | Values | Units |
|------------------|---------------------------------|-------------|------------------|
| ID | Three phase, full wave Tc=100°C | 160 | A |
| IFSM | t=10mS Tvj =45°C | 1800 | A |
| i ² t | t=10mS Tvj =45°C | 16200 | A ² s |
| Visol | a.c.50HZ;r.m.s.;1min | 3000 | V |
| Tvj | | -40 to +150 | °C |
| Tstg | | -40 to +125 | °C |
| Mt | To terminals(M6) | 5±15% | Nm |
| Ms | To heatsink(M6) | 5±15% | Nm |
| Weight | Module (Approximately) | 194 | g |

Thermal Characteristics

| Symbol | Conditions | Values | Units |
|----------|------------|--------|-------|
| Rth(j-c) | Per diode | 0.65 | °C/W |
| Rth(c-s) | Module | 0.03 | °C/W |

Electrical Characteristics

| Symbol | Conditions | Values | | | Units |
|--------|---|--------|------|----------|----------|
| | | Min. | Typ. | Max. | |
| VFM | T=25°C IF =300A | — | 1.50 | 1.75 | V |
| IRD | Tvj=25°C VRD=VRRM Tvj=150°C VRD=VRRM | — | — | 0.5 6 | mA mA |



Performance Curves

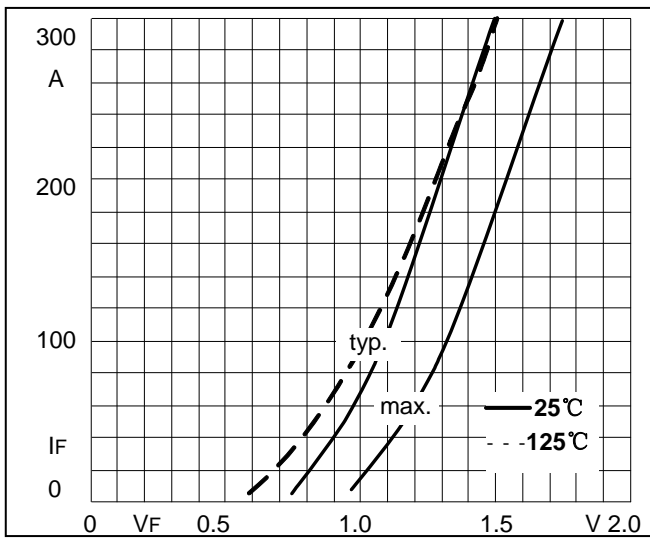

Fig1. Forward Characteristics

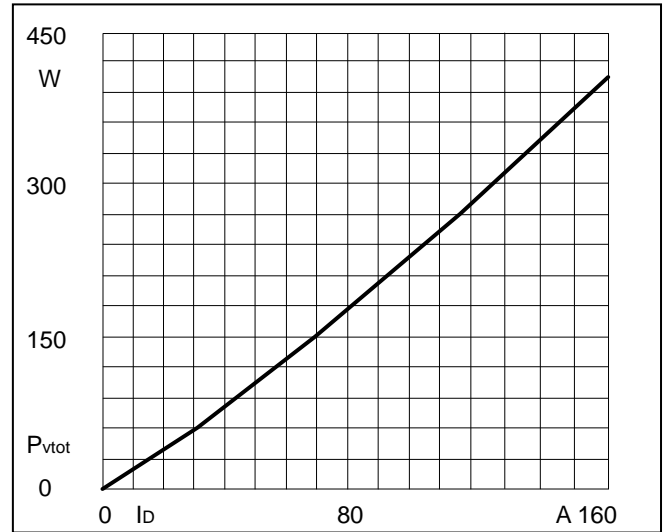

Fig2. Power dissipation

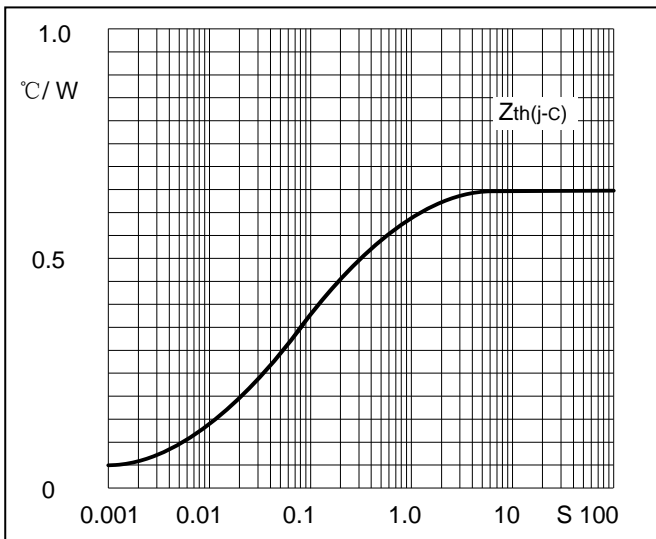

Fig3. Transient thermal impedance

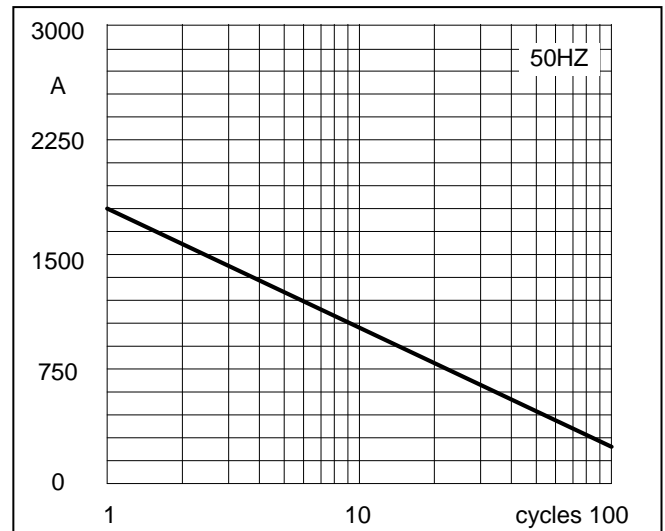

Fig4. Max Non-Repetitive Forward Surge Current

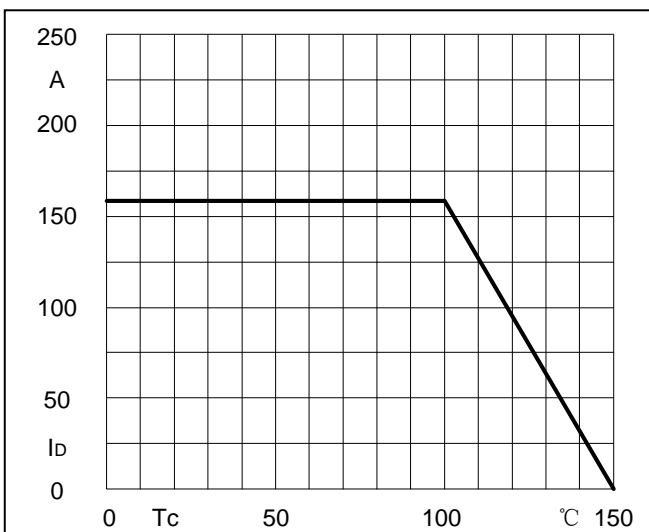
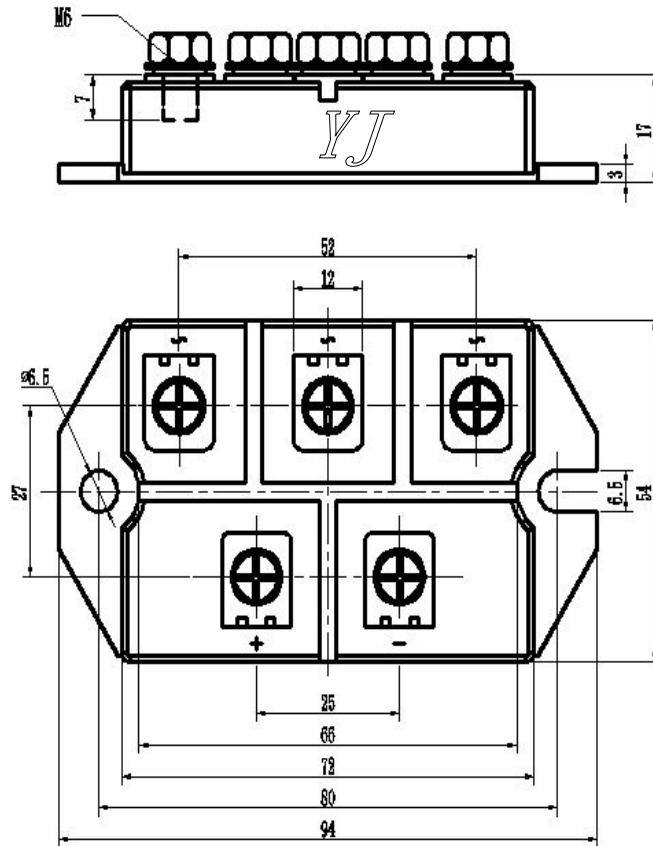

Fig5. Forward Current Derating Curve



Package Outline Information

CASE: M5



Dimensions in mm