

5x

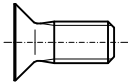

M6x12

5x

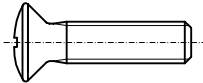

M6x30

5x

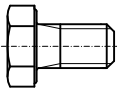

M6x16

5x

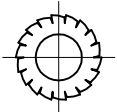

5,3

15x

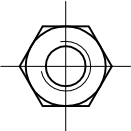

M6

5x

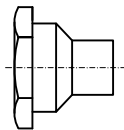

M5

5x



für M6



SZ
2519.000

Raum für Verpackungsdatum
Area for date of packing
(MMJJTT / MMYDD)

5x

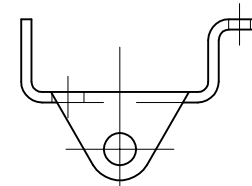

5x

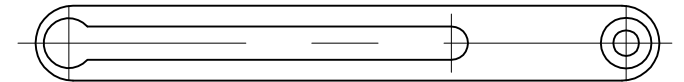

5x

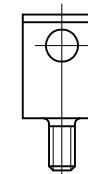

Zchng.-Nr. / No. of dwg. : A3262201SZ

Versandbeutel-Nr. / No. of accessory bag : -

Lieferanten-Nr. / No. of supplier :

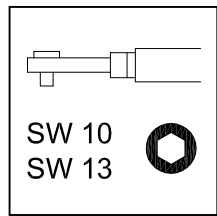
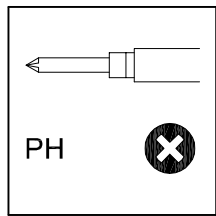
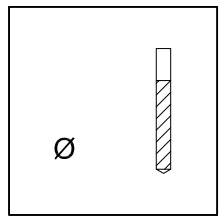
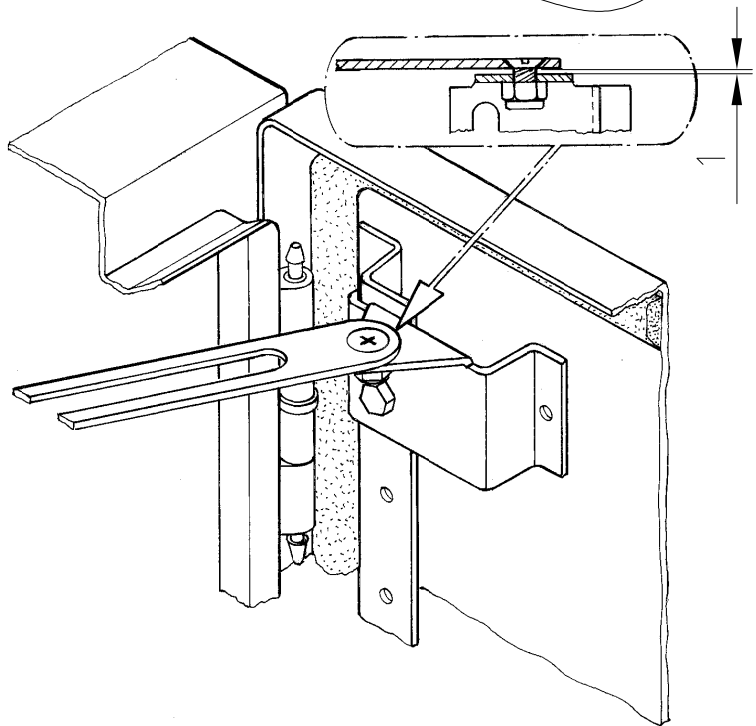
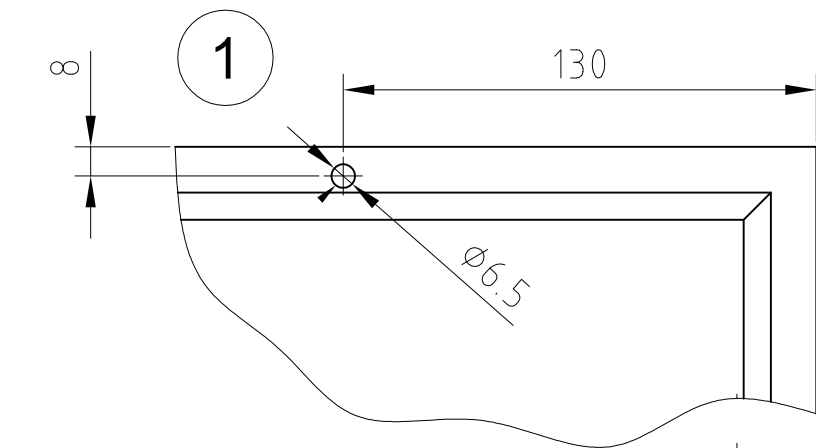

3

