

## LM341 and LM78M05 Series 3-Terminal 500-mA Positive Voltage Regulators

### 1 Features

- For a lower cost alternative, see the [UA78M](#)
- Output current in excess of 0.5 A
- No external components
- Internal thermal overload protection
- Internal short circuit current-limiting
- Output transistor safe-area compensation
- Available in 3-pin TO-220, TO-252, and TO packages
- Output voltages of 5 V and 15 V

### 2 Applications

- [Electronic point-of-sale](#)
- [Motor drives](#)
- [Building automation](#)
- [Appliances and white goods](#)
- [TVs and set-top boxes](#)

### 3 Description

The LM341 and LM78M05 three-pin positive voltage regulators employ built-in current limiting, thermal shutdown, and safe-operating area protection, which makes them virtually immune to damage from output overloads.

With adequate heat sinking, they can deliver in excess of 0.5-A output current. Typical applications would include local (on-card) regulators which can eliminate the noise and degraded performance associated with single-point regulation.

#### Device Information<sup>(1)</sup>

PART NUMBER	PACKAGE	BODY SIZE (NOM)
LM341	TO-220 (3)	10.16 mm × 14.986 mm
LM78M05	TO-220 (3)	10.16 mm × 14.986 mm
	TO-252 (3)	6.10 mm × 6.58 mm
	TO (3)	9.14 mm × 9.14 mm

(1) For all available packages, see the orderable addendum at the end of the data sheet.

#### Available Pinouts

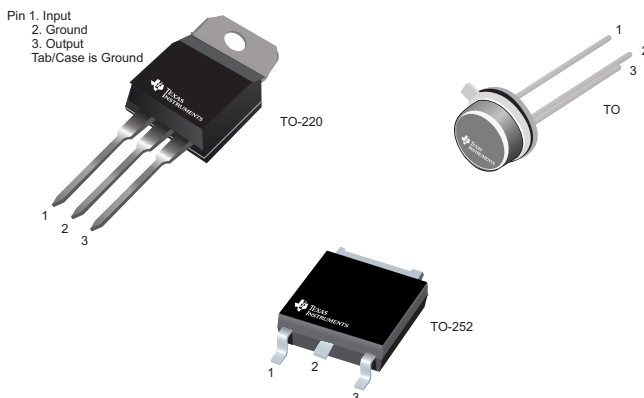

#### Typical Application

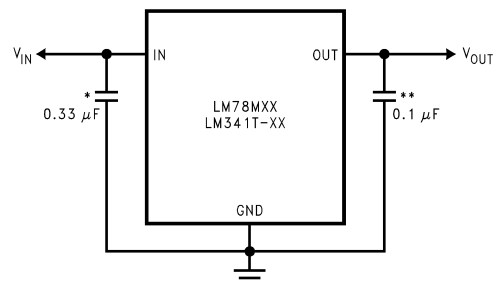

## Table of Contents

<b>1 Features</b> .....	1	8.3 Feature Description.....	10
<b>2 Applications</b> .....	1	8.4 Device Functional Modes.....	10
<b>3 Description</b> .....	1	<b>9 Application and Implementation</b> .....	11
<b>4 Revision History</b> .....	2	9.1 Application Information.....	11
<b>5 Device Comparison Table</b> .....	3	9.2 Typical Application .....	11
<b>6 Pin Configuration and Functions</b> .....	4	<b>10 Power Supply Recommendations</b> .....	12
<b>7 Specifications</b> .....	4	<b>11 Layout</b> .....	12
7.1 Absolute Maximum Ratings .....	4	11.1 Layout Guidelines .....	12
7.2 Recommended Operating Conditions.....	4	11.2 Layout Example .....	15
7.3 Thermal Information .....	5	<b>12 Device and Documentation Support</b> .....	16
7.4 Electrical Characteristics: LM341 (5 V) and LM78M05 .....	5	12.1 Documentation Support .....	16
7.5 Electrical Characteristics: LM341 (12 V).....	5	12.2 Related Links .....	16
7.6 Electrical Characteristics: LM341 (15 V).....	6	12.3 Receiving Notification of Documentation Updates .....	16
7.7 Typical Characteristics.....	7	12.4 Support Resources .....	16
<b>8 Detailed Description</b> .....	9	12.5 Trademarks .....	16
8.1 Overview .....	9	12.6 Electrostatic Discharge Caution.....	16
8.2 Functional Block Diagram .....	9	12.7 Glossary .....	16
		<b>13 Mechanical, Packaging, and Orderable Information</b> .....	16

## 4 Revision History

NOTE: Page numbers for previous revisions may differ from page numbers in the current version.

Changes from Revision F (December 2016) to Revision G	Page
• Added lower cost alternative bullet to <i>Features</i> section .....	1
• Changed <i>Applications</i> section .....	1
• Added <i>Device Comparison Table</i> .....	3
• Changed OUTPUT from pin 2 to pin 3 in <i>Pin Functions</i> table .....	4

Changes from Revision E (August 2005) to Revision F	Page
• Added <i>Applications</i> section, <i>Device Information</i> table, <i>Pin Configuration and Functions</i> section, <i>ESD Ratings</i> table, <i>Recommended Operating Conditions</i> table, <i>Thermal Information</i> table, <i>Detailed Description</i> section, <i>Application and Implementation</i> section, <i>Power Supply Recommendations</i> section, <i>Layout</i> section, <i>Device and Documentation Support</i> section, and <i>Mechanical, Packaging, and Orderable Information</i> section.....	1
• Deleted parts marked as obsolete: LM78M12 and LM78M15.....	1
• Changed package type names throughout.....	1
• Deleted 12-V output voltage option from <i>Features</i> .....	1
• Changed $R_{\theta JA}$ values in <i>Thermal Information</i> table From: 60°C/W To: 22.6°C/W (NDE), From: 92°C/W To: 38°C/W (NDP), and From: 120°C/W To: 162.4°C/W (NDT) .....	5
• Changed $R_{\theta JC(top)}$ values in <i>Thermal Information</i> table From: 5°C/W To: 17.8°C/W (NDE), From: 10°C/W To: 48.4°C/W (NDP), and From: 18°C/W To: 23.9°C/W (NDT).....	5
• Updated <i>Thermal Considerations</i> section .....	13

## 5 Device Comparison Table

I <sub>OUT</sub>	PARAMETER	LM78xx	UA78	LM340	LM340A	UNIT
1.5 A	Input voltage range	7 - 35	7 - 38	7 - 35	7 - 35	V
	Fixed output voltage option	5, 12, 15	5, 8, 10, 12, 15, 24	5, 12, 15	5, 12, 15	V
	Load regulation accuracy	4	4	4	2	%
	PSRR (120 Hz)	80	78	80	80	dB
	Recommended operating temperature	0 - 125	0 - 125	0 - 125	0 - 125	°C
	TO-220 T <sub>JA</sub>	23.9	19	23.9	23.9	°C/W
	SOT-223 T <sub>JA</sub>	62.1	N/A	62.1	62.1	°C/W
	TO-3 T <sub>JA</sub>	39	N/A	39	39	°C/W
TO-263 T <sub>JA</sub>	44.8	25.3	44.8	44.8	°C/W	
0.5 A		<b>LM78Mxx</b>	<b>UA78MxxC</b>	<b>UA78MxxI</b>	<b>LM341</b>	
	Input voltage range	7.2 - 35	5.3 - 30	5.3 - 30	7.2 - 35	V
	Fixed output voltage option	5	3.3, 5, 6, 8, 9, 10, 12	3.3, 5	5	V
	Load regulation accuracy	4	3	3	4	%
	PSRR (120 Hz)	78	80	80	78	dB
	Recommended operating temperature	-40 - 125	0 - 125	-40 - 125	-40 - 125	°C
	TO-220 T <sub>JA</sub>	22.6	19	19	22.6	°C/W
	SOT-223 T <sub>JA</sub>	N/A	53	53	N/A	°C/W
	TO-3 T <sub>JA</sub>	162.4	N/A	N/A	N/A	°C/W
	TO-252 Powerflex T <sub>JA</sub>	N/A	28	28	N/A	°C/W
TO-252 T <sub>JA</sub>	38	30.3	30.3	N/A	°C/W	
0.1 A		<b>LM78LxxAC</b>	<b>LM78LxxAI / LM78LxxIT</b>	<b>UA78LxxC</b>	<b>UA78LxxI</b>	
	Input voltage range	7.0 - 30	7.0 - 30	4.75 - 30	4.75 - 30	V
	Fixed output voltage option	5, 6.2, 12, 15	5, 9	2.6, 5, 6.2, 8, 9, 10, 12, 15	5	V
	Load regulation accuracy (A/non -A)	4	4	4/8	4/8	%
	PSRR (120 Hz)	62	62	51	51	dB
	Recommended operating temperature	0 - 125	-40 - 125	0 - 125	-40 - 125	°C
	SOT-89 T <sub>JA</sub>	N/A	N/A	54.7	54.7	°C/W
	SO-8 T <sub>JA</sub>	128.8	128.8	115	115	°C/W
DSBGA T <sub>JA</sub>	N/A	108.4	N/A	N/A	°C/W	
TO-92 T <sub>JA</sub>	158.7	N/A	143.6	143.6	°C/W	

## 6 Pin Configuration and Functions

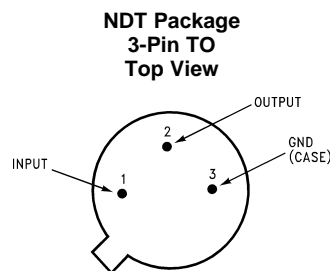
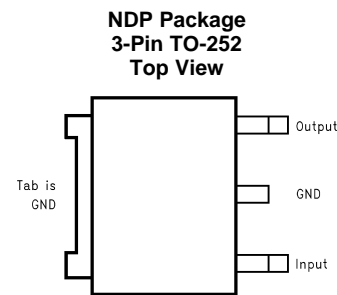
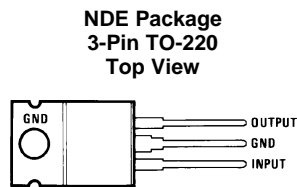

### Pin Functions

NAME	PIN NO.			I/O	DESCRIPTION
	TO-220	TO-252	TO		
GND	2/TAB	2/TAB	3	—	Tab is GND
INPUT	1	1	1	I	Input
OUTPUT	3	3	2	O	Output

## 7 Specifications

### 7.1 Absolute Maximum Ratings

over operating free-air temperature range (unless otherwise noted)<sup>(1)(2)</sup>

	MIN	MAX	UNIT	
Input voltage	$V_O = 5\text{ V to }15\text{ V}$		35	V
Power dissipation	Internally limited			
Lead temperature (Soldering, 10 s)	TO package (NDT)		300	°C
	TO-220 package (NDE)		260	
Operating junction temperature	-40	125	°C	
Storage temperature, $T_{stg}$	-65	150	°C	

- (1) Stresses beyond those listed under *Absolute Maximum Ratings* may cause permanent damage to the device. These are stress ratings only, which do not imply functional operation of the device at these or any other conditions beyond those indicated under *Recommended Operating Conditions*. Exposure to absolute-maximum-rated conditions for extended periods may affect device reliability.
- (2) If Military/Aerospace specified devices are required, please contact the Texas Instruments Sales Office/Distributors for availability and specifications.

### 7.2 Recommended Operating Conditions

over operating free-air temperature range (unless otherwise noted)

	MIN	MAX	UNIT
Input voltage	$V_{OUT} + 1.8$	35	V
Output current		0.5	A

### 7.3 Thermal Information

THERMAL METRIC <sup>(1)</sup>		LM341	LM78M05		UNIT
		NDE (TO-220)	NDP (TO-252)	NDT (TO)	
		3 PINS	3 PINS	3 PINS	
R <sub>θJA</sub>	Junction-to-ambient thermal resistance	22.6	38	162.4	°C/W
R <sub>θJC(top)</sub>	Junction-to-case (top) thermal resistance	17.8	48.4	23.9	°C/W
R <sub>θJB</sub>	Junction-to-board thermal resistance	6	17.7	—	°C/W
ψ <sub>JT</sub>	Junction-to-top characterization parameter	3.3	6.7	—	°C/W
ψ <sub>JB</sub>	Junction-to-board characterization parameter	6	17.9	—	°C/W
R <sub>θJC(bot)</sub>	Junction-to-case (bottom) thermal resistance	1.3	4.4	—	°C/W

(1) For more information about traditional and new thermal metrics, see the [Semiconductor and IC package thermal metrics application report](#).

### 7.4 Electrical Characteristics: LM341 (5 V) and LM78M05

V<sub>IN</sub> = 10 V, C<sub>IN</sub> = 0.33 μF, C<sub>O</sub> = 0.1 μF, T<sub>J</sub> = 25°C (unless otherwise noted). Limits are specified by production testing or correlation techniques using standard Statistical Quality Control (SQC) methods.

PARAMETER		TEST CONDITIONS	MIN	TYP	MAX	UNIT
V <sub>O</sub>	Output voltage	I <sub>L</sub> = 500 mA	4.8	5	5.2	V
		I <sub>L</sub> = 5 mA to 500 mA, P <sub>D</sub> ≤ 7.5 W, V <sub>IN</sub> = 7.5 V to 20 V, T <sub>J</sub> = -40°C to 125°C	4.75	5	5.25	
V <sub>RLINE</sub>	Line regulation	V <sub>IN</sub> = 7.2 V to 25 V	I <sub>L</sub> = 100 mA		50	mV
			I <sub>L</sub> = 500 mA		100	
V <sub>RLOAD</sub>	Load regulation	I <sub>L</sub> = 5 mA to 500 mA			100	mV
I <sub>Q</sub>	Quiescent current	I <sub>L</sub> = 500 mA		4	10	mA
ΔI <sub>Q</sub>	Quiescent current change	I <sub>L</sub> = 5 mA to 500 mA		0.5		mA
		V <sub>IN</sub> = 7.5 V to 25 V, I <sub>L</sub> = 500 mA		1		
V <sub>n</sub>	Output noise voltage	f = 10 Hz to 100 kHz		40		μV
ΔV <sub>IN</sub>	Ripple rejection	f = 120 Hz, I <sub>L</sub> = 500 mA		78		dB
V <sub>IN</sub>	Input voltage required to maintain line regulation	I <sub>L</sub> = 500 mA	7.2			V
ΔV <sub>O</sub>	Long-term stability	I <sub>L</sub> = 500 mA, T <sub>J</sub> = -40°C to 125°C			20	mV/khrs

### 7.5 Electrical Characteristics: LM341 (12 V)

V<sub>IN</sub> = 19 V, C<sub>IN</sub> = 0.33 μF, C<sub>O</sub> = 0.1 μF, T<sub>J</sub> = 25°C (unless otherwise noted). Limits are specified by production testing or correlation techniques using standard Statistical Quality Control (SQC) methods.

PARAMETER		TEST CONDITIONS	MIN	TYP	MAX	UNIT
V <sub>O</sub>	Output voltage	I <sub>L</sub> = 500 mA	11.5	12	12.5	V
		I <sub>L</sub> = 5 mA to 500 mA, P <sub>D</sub> ≤ 7.5 W, V <sub>IN</sub> = 14.8 V to 27 V, T <sub>J</sub> = -40°C to 125°C	11.4	12	12.6	
V <sub>RLINE</sub>	Line regulation	V <sub>IN</sub> = 14.5 V to 30 V	I <sub>L</sub> = 100 mA		120	mV
			I <sub>L</sub> = 500 mA		240	
V <sub>RLOAD</sub>	Load regulation	I <sub>L</sub> = 5 mA to 500 mA			240	mV
I <sub>Q</sub>	Quiescent current	I <sub>L</sub> = 500 mA		4	10	mA
ΔI <sub>Q</sub>	Quiescent current change	I <sub>L</sub> = 5 mA to 500 mA		0.5		mA
		V <sub>IN</sub> = 14.8 V to 30 V, I <sub>L</sub> = 500 mA		1		
V <sub>n</sub>	Output noise voltage	f = 10 Hz to 100 kHz		75		μV
ΔV <sub>IN</sub>	Ripple rejection	f = 120 Hz, I <sub>L</sub> = 500 mA		71		dB
V <sub>IN</sub>	Input voltage required to maintain line regulation	I <sub>L</sub> = 500 mA	14.5			V
ΔV <sub>O</sub>	Long-term stability	I <sub>L</sub> = 500 mA, T <sub>J</sub> = -40°C to 125°C			48	mV/khrs

## 7.6 Electrical Characteristics: LM341 (15 V)

$V_{IN} = 23\text{ V}$ ,  $C_{IN} = 0.33\text{ }\mu\text{F}$ ,  $C_O = 0.1\text{ }\mu\text{F}$ ,  $T_J = 25^\circ\text{C}$  (unless otherwise noted). Limits are specified by production testing or correlation techniques using standard Statistical Quality Control (SQC) methods.

PARAMETER		TEST CONDITIONS	MIN	TYP	MAX	UNIT
$V_O$	Output voltage	$I_L = 500\text{ mA}$	14.4	15	15.6	V
		$I_L = 5\text{ mA to }500\text{ mA}$ , $P_D \leq 7.5\text{ W}$ , $V_{IN} = 18\text{ V to }30\text{ V}$ , $T_J = -40^\circ\text{C to }125^\circ\text{C}$	14.25	15	15.75	
$V_{RLINE}$	Line regulation	$V_{IN} = 17.6\text{ V to }30\text{ V}$	$I_L = 100\text{ mA}$		150	mV
			$I_L = 500\text{ mA}$		300	
$V_{RLOAD}$	Load regulation	$I_L = 5\text{ mA to }500\text{ mA}$			300	mV
$I_Q$	Quiescent current	$I_L = 500\text{ mA}$		4	10	mA
$\Delta I_Q$	Quiescent current change	$I_L = 5\text{ mA to }500\text{ mA}$			0.5	mA
		$V_{IN} = 18\text{ V to }30\text{ V}$ , $I_L = 500\text{ mA}$			1	
$V_n$	Output noise voltage	$f = 10\text{ Hz to }100\text{ kHz}$		90		$\mu\text{V}$
$\Delta V_{IN}$	Ripple rejection	$f = 120\text{ Hz}$ , $I_L = 500\text{ mA}$		69		dB
$V_{IN}$	Input voltage required to maintain line regulation	$I_L = 500\text{ mA}$		17.6		V
$\Delta V_O$	Long-term stability	$I_L = 500\text{ mA}$ , $T_J = -40^\circ\text{C to }125^\circ\text{C}$			60	mV/khrs

### 7.7 Typical Characteristics

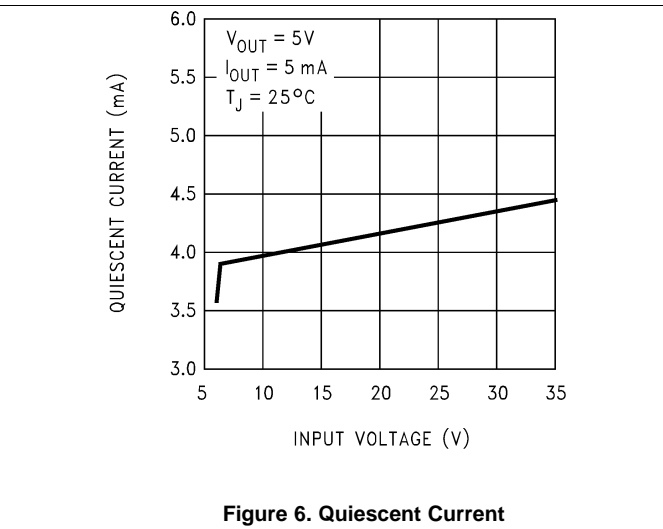
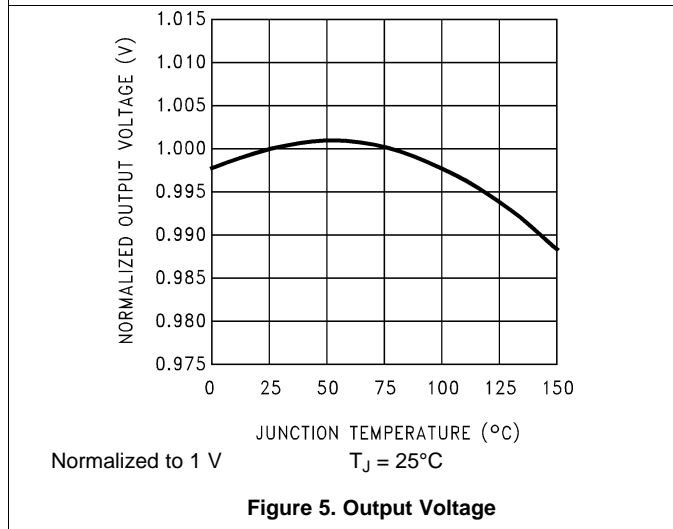
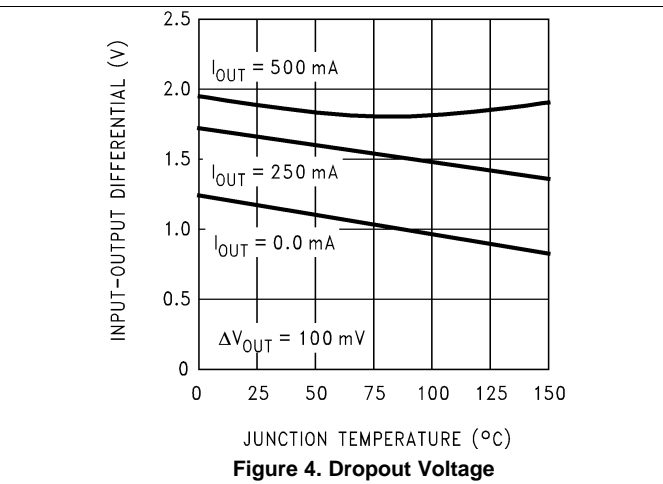
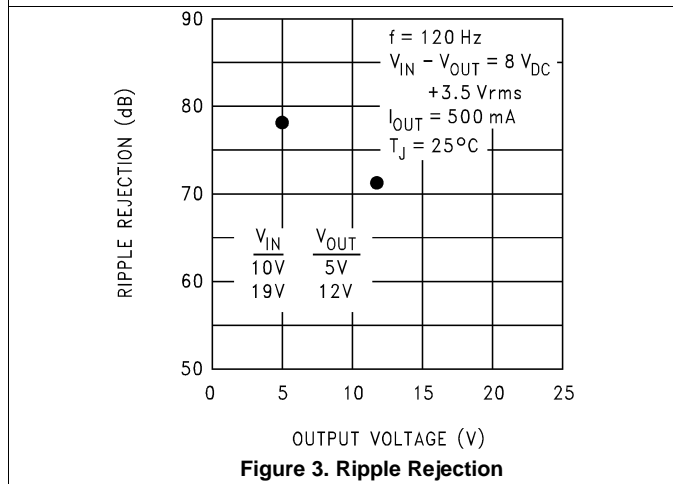
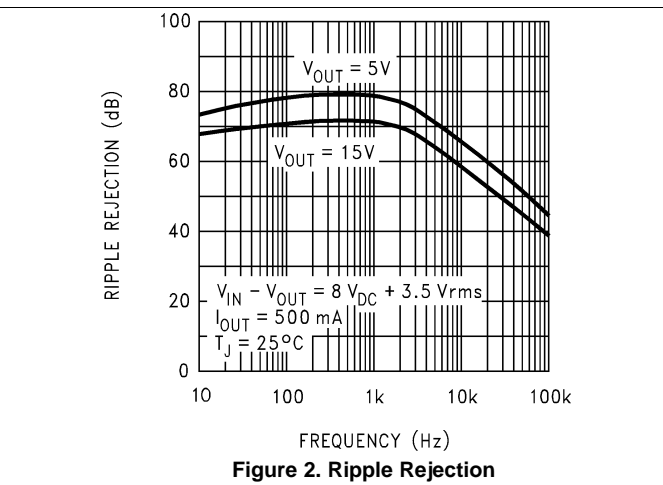
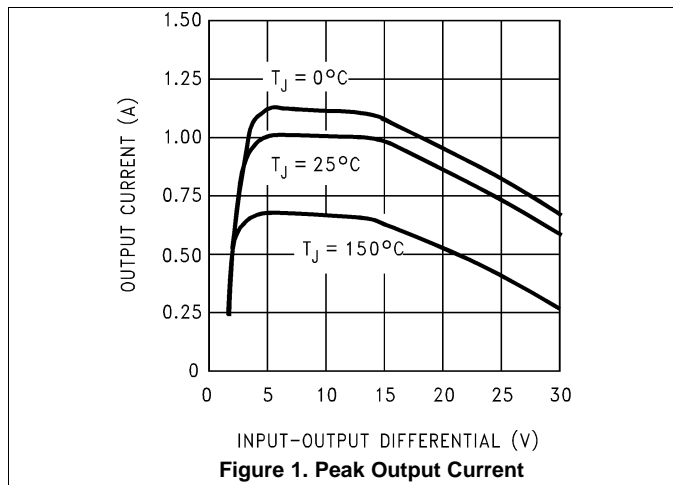

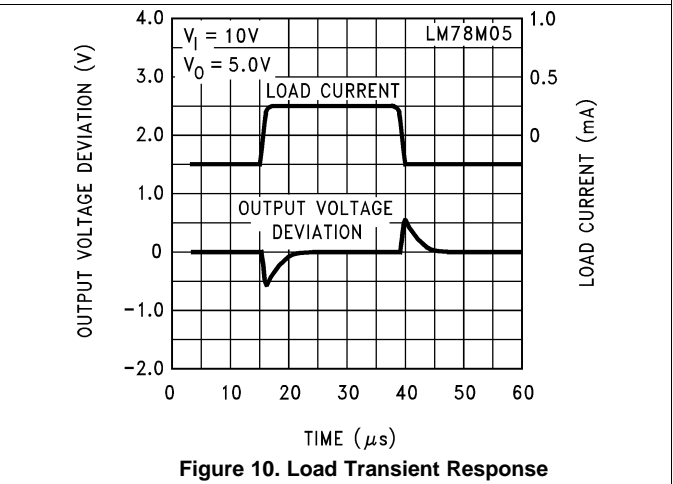
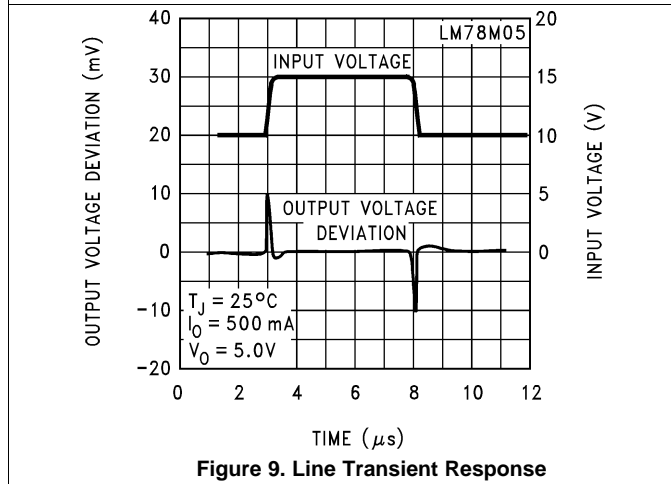
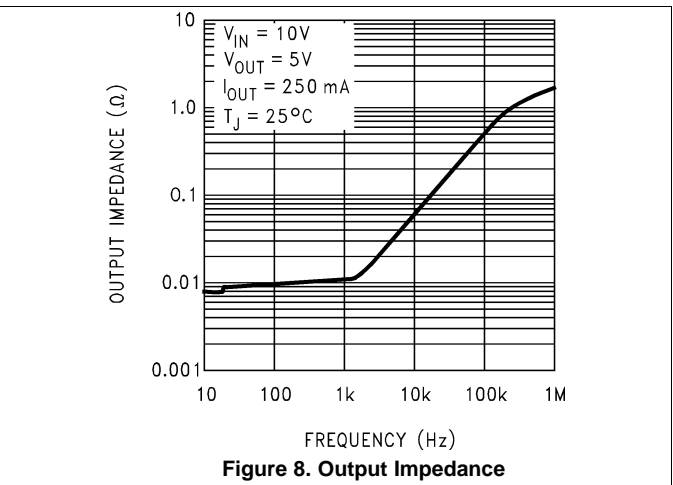
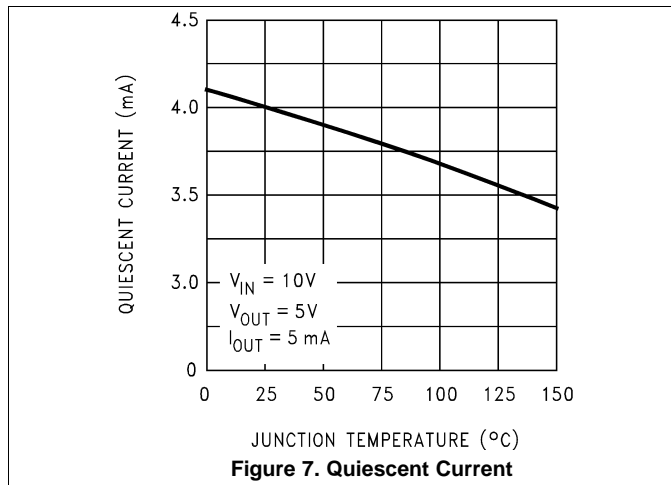
**Typical Characteristics (continued)**



## 8 Detailed Description

### 8.1 Overview

The LM341 and LM78M05 devices are a family of fixed positive voltage regulators. They can accept up to 35 V at the input and regulate it down to outputs of 5 V, 12 V, or 15 V. The devices are capable of supplying up to 500 mA of output current, although it is important to ensure there is adequate heat sinking to avoid exceeding thermal limits. However, in the case of accidental overload the device has built in current limiting, thermal shutdown and safe-operating area protection to prevent damage from occurring.

### 8.2 Functional Block Diagram

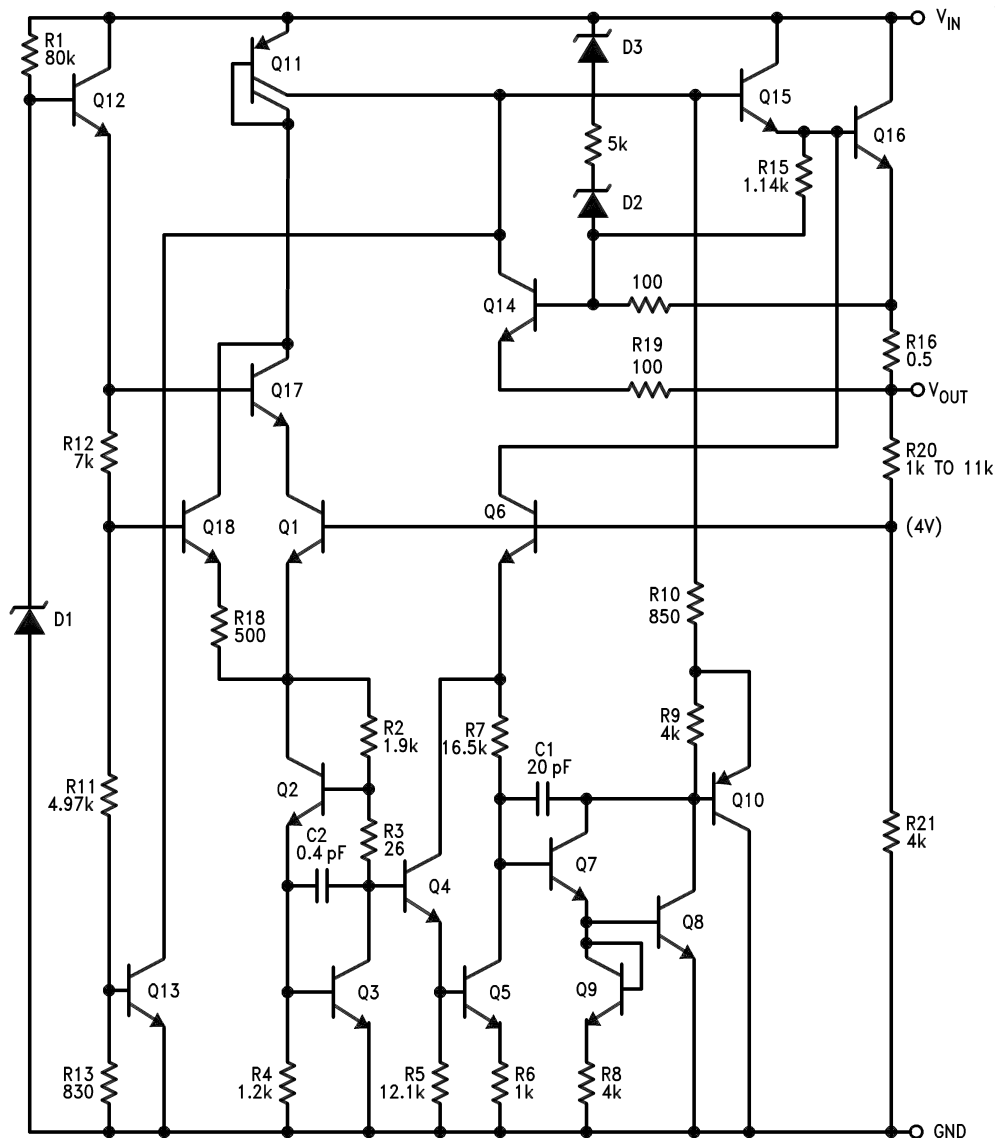

### 8.3 Feature Description

The LM341 and LM78M05 fixed voltage regulators have built-in thermal overload protection which prevents the device from being damaged due to excessive junction temperature.

The regulators also contain internal short-circuit protection which limits the maximum output current, and safe-area protection for the pass transistor which reduces the short-circuit current as the voltage across the pass transistor is increased.

Although the internal power dissipation is automatically limited, the maximum junction temperature of the device must be kept below 125°C to meet data sheet specifications. An adequate heat sink must be provided to assure this limit is not exceeded under worst-case operating conditions (maximum input voltage and load current) if reliable performance is to be obtained.

### 8.4 Device Functional Modes

#### 8.4.1 Normal Operation

The device OUTPUT pin sources current necessary to make the voltage at the OUTPUT pin equal to the fixed voltage level of the device.

#### 8.4.2 Operation With Low Input Voltage

The device requires up to 2-V headroom ( $V_I - V_O$ ) to operate in regulation. With less headroom, the device may drop out of regulation in which the OUTPUT voltage would equal INPUT voltage minus dropout voltage.

#### 8.4.3 Operation in Self Protection

When an overload occurs, the device shuts down Darlington NPN output stage or reduce the output current to prevent device damage. The device automatically resets from the overload. The output may be reduced or alternate between on and off until the overload is removed.

## 9 Application and Implementation

### NOTE

Information in the following applications sections is not part of the TI component specification, and TI does not warrant its accuracy or completeness. TI's customers are responsible for determining suitability of components for their purposes. Customers should validate and test their design implementation to confirm system functionality.

### 9.1 Application Information

The LM341 and LM78Mxx devices are fixed voltage regulators meaning no external feedback resistors are required to set the output voltage. Input and output capacitors are also not required for the device to be stable. However input capacitance helps filter noise from the supply and output capacitance improves the transient response.

### 9.2 Typical Application

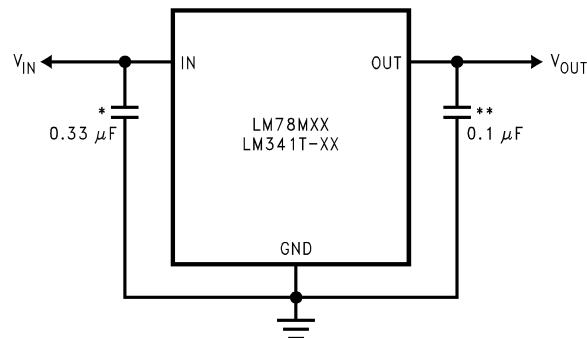

\*Required if regulator input is more than 4 inches from input filter capacitor (or if no input filter capacitor is used).

\*\*Optional for improved transient response.

Figure 11. Typical Application

#### 9.2.1 Design Requirements

For this design example, use the parameters listed in [Table 1](#) as the input parameters.

Table 1. Design Parameters

PARAMETER	VALUE
$C_{IN}$	0.33 $\mu F$
$C_{OUT}$	0.1 $\mu F$

#### 9.2.2 Detailed Design Procedure

##### 9.2.2.1 Input Voltage

Regardless of the output voltage option being used (5 V, 12 V, 15 V), the input voltage must be at least 2 V greater to ensure proper regulation (7 V, 14 V, 17 V).

##### 9.2.2.2 Output Current

Depending on the input-output voltage differential, the output current must be limited to ensure maximum power dissipation is not exceeded. The graph in [Figure 1](#) shows the appropriate current limit for a variety of conditions.

##### 9.2.2.3 Input Capacitor

If no power supply filter capacitor is used or if the device is placed more than four inches away from the capacitor of the power supply, an additional capacitor placed at the input pin of the device helps bypass noise.

### 9.2.2.4 Output Capacitor

These devices are designed to be stable with no output capacitance and can be omitted from the design if needed. However if large changes in load are expected, an output capacitor is recommended to improve the transient response.

### 9.2.3 Application Curves

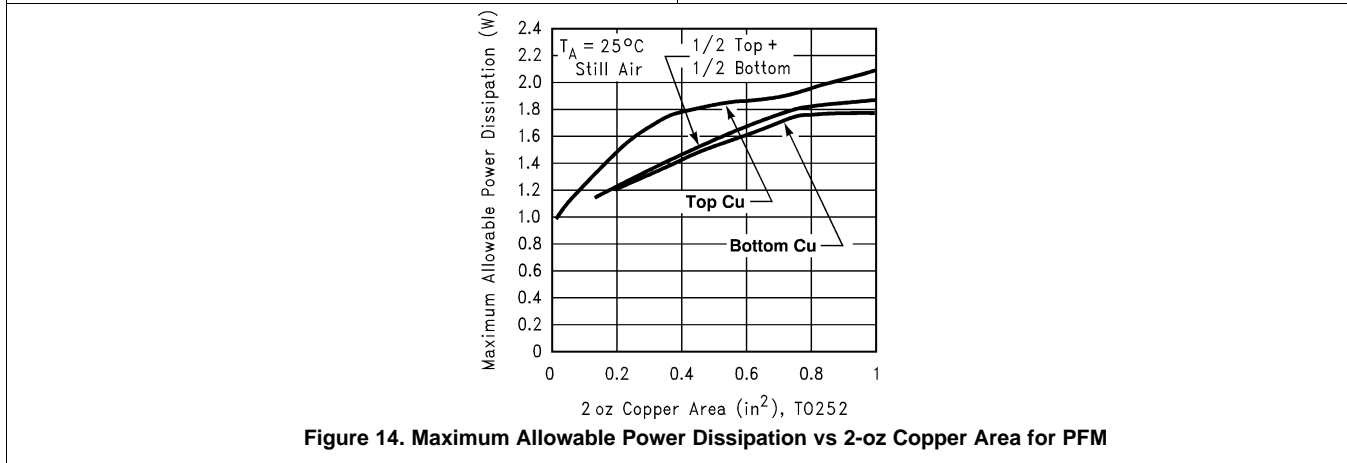
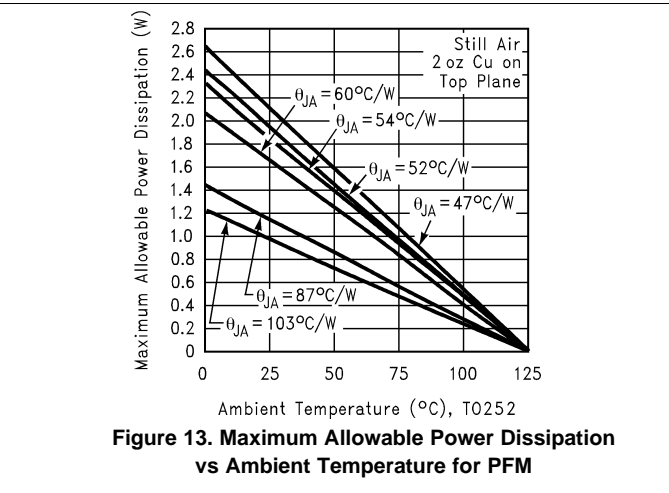
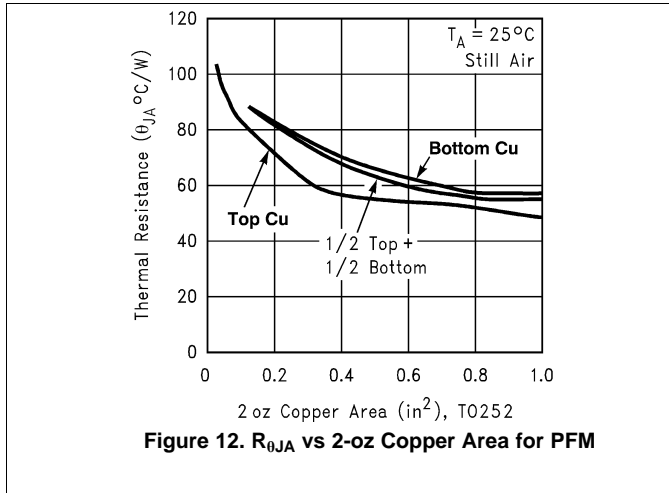

## 10 Power Supply Recommendations

The LM341 and LM78M05 devices are designed to operate from an input voltage supply range between  $V_{OUT} + 2\text{ V}$  to 35 V. If the device is more than four inches from the power supply filter capacitors, an input bypass capacitor 0.1- $\mu\text{F}$  or greater of any type is recommended.

## 11 Layout

### 11.1 Layout Guidelines

Some layout guidelines must be followed to ensure proper regulation of the output voltage with minimum noise. TI recommends that the input terminal be bypassed to ground with a bypass capacitor. The optimum placement is closest to the input terminal of the device and the system GND. Take care to minimize the loop area formed by the bypass-capacitor connection, the input terminal, and the system GND. Traces carrying the load current must be wide to reduce the amount of parasitic trace inductance. In cases when  $V_{IN}$  shorts to ground, an external diode must be placed from  $V_{OUT}$  to  $V_{IN}$  to divert the surge current from the output capacitor and protect the IC. This diode must be placed close to the corresponding IC pins to increase their effectiveness.

## Layout Guidelines (continued)

### 11.1.1 Thermal Considerations

When an integrated circuit operates with appreciable current, its junction temperature is elevated. It is important to quantify its thermal limits to achieve acceptable performance and reliability. This limit is determined by summing the individual parts consisting of a series of temperature rises from the semiconductor junction to the operating environment. A one-dimension steady-state model of conduction heat transfer is demonstrated in Figure 15. The heat generated at the device junction flows through the die to the die attach pad, through the lead frame to the surrounding case material, to the printed-circuit board, and eventually to the ambient environment.

There are several variables that may affect the thermal resistance and in turn the need for a heat sink, which includes the following.

Component variables ( $R_{\theta JC}$ )

- Leadframe size and material
- Number of conduction pins
- Die size
- Die attach material
- Molding compound size and material

Application variables ( $R_{\theta CA}$ )

- Mounting pad size, material, and location
- Placement of mounting pad
- PCB size and material
- Traces length and width
- Adjacent heat sources
- Volume of air
- Ambient temperature
- Shape of mounting pad

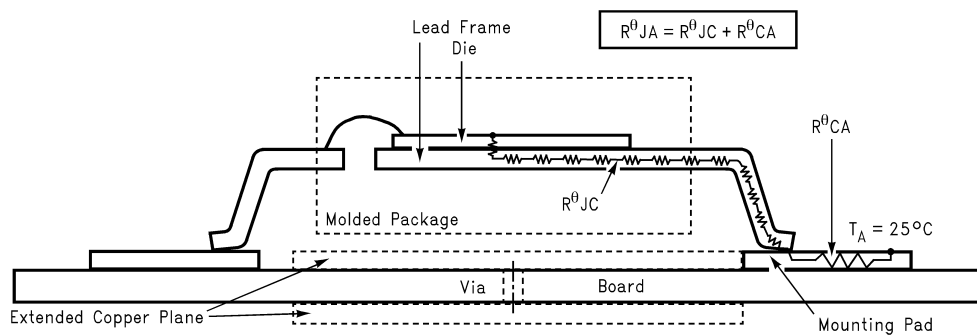

The case temperature is measured at the point where the leads contact the mounting pad surface

**Figure 15. Cross-Sectional View of Integrated Circuit Mounted on a Printed-Circuit Board**

The LM341 and LM78M05 regulators have internal thermal shutdown to protect the device from overheating. Under all possible operating conditions, the junction temperature of the LM341 and LM78M05 must be within the range of 0°C to 125°C. A heat sink may be required depending on the maximum power dissipation and maximum ambient temperature of the application. To determine if a heat sink is needed, the power dissipated by the regulator ( $P_D$ ) is calculated using Equation 1.

$$I_{IN} = I_L + I_G \quad (1)$$

$$P_D = (V_{IN} - V_{OUT}) \times I_L + (V_{IN} \times I_G) \quad (2)$$

## Layout Guidelines (continued)

Figure 16 shows the voltages and currents which are present in the circuit.

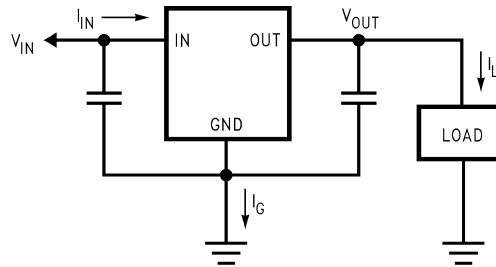

**Figure 16. Power Dissipation Diagram**

The next parameter which must be calculated is the maximum allowable temperature rise,  $T_{R(MAX)}$ .

$$T_{R(MAX)} = T_{J(MAX)} - T_{A(MAX)}$$

where

- $T_{J(MAX)}$  is the maximum allowable junction temperature (125°C)
- $T_{A(MAX)}$  is the maximum ambient temperature encountered in the application

Using the calculated values for  $T_{R(MAX)}$  and  $P_D$ , the maximum allowable value for the junction-to-ambient thermal resistance ( $R_{\theta JA}$ ) can be calculated with Equation 3.

$$R_{\theta JA} = T_{R(MAX)} / P_D \quad (3)$$

As a design aid, Table 2 lists the value of the  $R_{\theta JA}$  of TO-252 for different heat sink area. The copper patterns that we used to measure these  $R_{\theta JA}$  are shown at the end of the [AN-1028 Maximum Power Enhancement Techniques for Power Packages application note](#). Figure 12 reflects the same test results as what are in the Table 2.

Figure 13 illustrates the maximum allowable power dissipation versus ambient temperature for the PFM device. Figure 14 illustrates the maximum allowable power dissipation versus copper area (in<sup>2</sup>) for the TO-252 device. For power enhancement techniques to be used with TO-252 package, see the [AN-1028 Maximum Power Enhancement Techniques for Power Packages application note](#).

## Layout Guidelines (continued)

Table 2.  $R_{\theta JA}$  Different Heat Sink Area

LAYOUT	COPPER AREA (in <sup>2</sup> )		THERMAL RESISTANCE: $R_{\theta JA}$ (°C/W)
	TOP SIDE <sup>(1)</sup>	BOTTOM SIDE	TO-252
1	0.0123	0	103
2	0.066	0	87
3	0.3	0	60
4	0.53	0	54
5	0.76	0	52
6	1	0	47
7	0	0.2	84
8	0	0.4	70
9	0	0.6	63
10	0	0.8	57
11	0	1	57
12	0.066	0.066	89
13	0.175	0.175	72
14	0.284	0.284	61
15	0.392	0.392	55
16	0.5	0.5	53

(1) Tab of device is attached to topside copper.

## 11.2 Layout Example

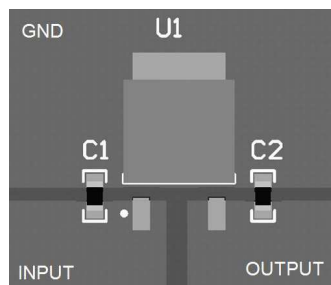

Figure 17. Layout Recommendation

## 12 Device and Documentation Support

### 12.1 Documentation Support

#### 12.1.1 Related Documentation

For related documentation see the following:

Texas Instruments, [AN-1028 Maximum Power Enhancement Techniques for Power Packages application note](#)

### 12.2 Related Links

The table below lists quick access links. Categories include technical documents, support and community resources, tools and software, and quick access to order now.

**Table 3. Related Links**

PARTS	PRODUCT FOLDER	ORDER NOW	TECHNICAL DOCUMENTS	TOOLS & SOFTWARE	SUPPORT & COMMUNITY
LM341	<a href="#">Click here</a>	<a href="#">Click here</a>	<a href="#">Click here</a>	<a href="#">Click here</a>	<a href="#">Click here</a>
LM78M05	<a href="#">Click here</a>	<a href="#">Click here</a>	<a href="#">Click here</a>	<a href="#">Click here</a>	<a href="#">Click here</a>

### 12.3 Receiving Notification of Documentation Updates

To receive notification of documentation updates, navigate to the device product folder on ti.com. In the upper right corner, click on *Alert me* to register and receive a weekly digest of any product information that has changed. For change details, review the revision history included in any revised document.

### 12.4 Support Resources

[TI E2E™ support forums](#) are an engineer's go-to source for fast, verified answers and design help — straight from the experts. Search existing answers or ask your own question to get the quick design help you need.

Linked content is provided "AS IS" by the respective contributors. They do not constitute TI specifications and do not necessarily reflect TI's views; see TI's [Terms of Use](#).

### 12.5 Trademarks

E2E is a trademark of Texas Instruments.

All other trademarks are the property of their respective owners.

### 12.6 Electrostatic Discharge Caution



These devices have limited built-in ESD protection. The leads should be shorted together or the device placed in conductive foam during storage or handling to prevent electrostatic damage to the MOS gates.

### 12.7 Glossary

[SLYZ022](#) — *TI Glossary*.

This glossary lists and explains terms, acronyms, and definitions.

## 13 Mechanical, Packaging, and Orderable Information

The following pages include mechanical, packaging, and orderable information. This information is the most current data available for the designated devices. This data is subject to change without notice and revision of this document. For browser-based versions of this data sheet, refer to the left-hand navigation.



**PACKAGING INFORMATION**

Orderable Device	Status (1)	Package Type	Package Drawing	Pins	Package Qty	Eco Plan (2)	Lead finish/ Ball material (6)	MSL Peak Temp (3)	Op Temp (°C)	Device Marking (4/5)	Samples
LM341T-15/NOPB	ACTIVE	TO-220	NDE	3	45	RoHS & Green	SN	Level-1-NA-UNLIM	-40 to 125	LM341T-15 LM78M15CT	
LM341T-5.0	NRND	TO-220	NDE	3	45	Non-RoHS & Non-Green	Call TI	Call TI	-40 to 125	LM341T-5.0 LM78M05CT	
LM341T-5.0/NOPB	ACTIVE	TO-220	NDE	3	45	RoHS & Green	SN	Level-1-NA-UNLIM	-40 to 125	LM341T-5.0 LM78M05CT	
LM78M05CDT	NRND	TO-252	NDP	3	75	Non-RoHS & Non-Green	Call TI	Call TI	-40 to 125	LM78M05 CDT	
LM78M05CDT/NOPB	ACTIVE	TO-252	NDP	3	75	RoHS & Green	SN	Level-2-260C-1 YEAR	-40 to 125	LM78M05 CDT	
LM78M05CDTX	NRND	TO-252	NDP	3	2500	Non-RoHS & Non-Green	Call TI	Call TI	-40 to 125	LM78M05 CDT	
LM78M05CDTX/NOPB	ACTIVE	TO-252	NDP	3	2500	RoHS & Green	SN	Level-2-260C-1 YEAR	-40 to 125	LM78M05 CDT	
LM78M05CT	NRND	TO-220	NDE	3	45	Non-RoHS & Non-Green	Call TI	Call TI	-40 to 125	LM341T-5.0 LM78M05CT	
LM78M05CT/NOPB	ACTIVE	TO-220	NDE	3	45	RoHS & Green	SN	Level-1-NA-UNLIM	-40 to 125	LM341T-5.0 LM78M05CT	
LM78M15CT/NOPB	ACTIVE	TO-220	NDE	3	45	RoHS & Green	SN	Level-1-NA-UNLIM	-40 to 125	LM341T-15 LM78M15CT	

(1) The marketing status values are defined as follows:

**ACTIVE:** Product device recommended for new designs.

**LIFEBUY:** TI has announced that the device will be discontinued, and a lifetime-buy period is in effect.

**NRND:** Not recommended for new designs. Device is in production to support existing customers, but TI does not recommend using this part in a new design.

**PREVIEW:** Device has been announced but is not in production. Samples may or may not be available.

**OBSOLETE:** TI has discontinued the production of the device.

(2) **RoHS:** TI defines "RoHS" to mean semiconductor products that are compliant with the current EU RoHS requirements for all 10 RoHS substances, including the requirement that RoHS substance do not exceed 0.1% by weight in homogeneous materials. Where designed to be soldered at high temperatures, "RoHS" products are suitable for use in specified lead-free processes. TI may reference these types of products as "Pb-Free".

**RoHS Exempt:** TI defines "RoHS Exempt" to mean products that contain lead but are compliant with EU RoHS pursuant to a specific EU RoHS exemption.

**Green:** TI defines "Green" to mean the content of Chlorine (Cl) and Bromine (Br) based flame retardants meet JS709B low halogen requirements of <=1000ppm threshold. Antimony trioxide based flame retardants must also meet the <=1000ppm threshold requirement.

- (3) MSL, Peak Temp. - The Moisture Sensitivity Level rating according to the JEDEC industry standard classifications, and peak solder temperature.
- (4) There may be additional marking, which relates to the logo, the lot trace code information, or the environmental category on the device.
- (5) Multiple Device Markings will be inside parentheses. Only one Device Marking contained in parentheses and separated by a "~" will appear on a device. If a line is indented then it is a continuation of the previous line and the two combined represent the entire Device Marking for that device.
- (6) Lead finish/Ball material - Orderable Devices may have multiple material finish options. Finish options are separated by a vertical ruled line. Lead finish/Ball material values may wrap to two lines if the finish value exceeds the maximum column width.

**Important Information and Disclaimer:**The information provided on this page represents TI's knowledge and belief as of the date that it is provided. TI bases its knowledge and belief on information provided by third parties, and makes no representation or warranty as to the accuracy of such information. Efforts are underway to better integrate information from third parties. TI has taken and continues to take reasonable steps to provide representative and accurate information but may not have conducted destructive testing or chemical analysis on incoming materials and chemicals. TI and TI suppliers consider certain information to be proprietary, and thus CAS numbers and other limited information may not be available for release.

In no event shall TI's liability arising out of such information exceed the total purchase price of the TI part(s) at issue in this document sold by TI to Customer on an annual basis.

**TAPE AND REEL INFORMATION**

**QUADRANT ASSIGNMENTS FOR PIN 1 ORIENTATION IN TAPE**

\*All dimensions are nominal

Device	Package Type	Package Drawing	Pins	SPQ	Reel Diameter (mm)	Reel Width W1 (mm)	A0 (mm)	B0 (mm)	K0 (mm)	P1 (mm)	W (mm)	Pin1 Quadrant
LM78M05CDTX	TO-252	NDP	3	2500	330.0	16.4	6.9	10.5	2.7	8.0	16.0	Q2
LM78M05CDTX/NOPB	TO-252	NDP	3	2500	330.0	16.4	6.9	10.5	2.7	8.0	16.0	Q2

**TAPE AND REEL BOX DIMENSIONS**

\*All dimensions are nominal

Device	Package Type	Package Drawing	Pins	SPQ	Length (mm)	Width (mm)	Height (mm)
LM78M05CDTX	TO-252	NDP	3	2500	367.0	367.0	35.0
LM78M05CDTX/NOPB	TO-252	NDP	3	2500	367.0	367.0	38.0

NDE0003B



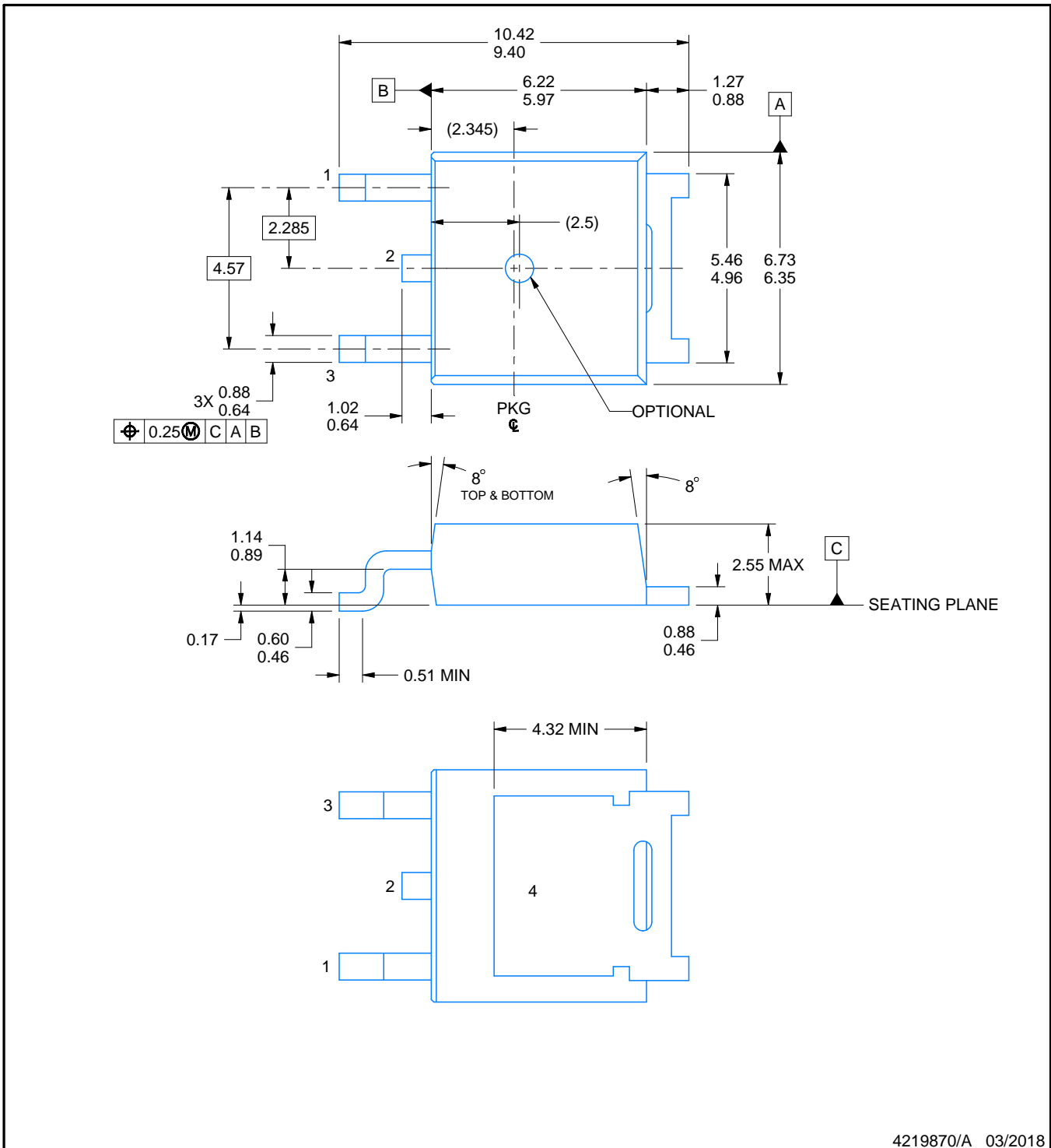

NOTES:

- All linear dimensions are in millimeters. Any dimensions in parenthesis are for reference only. Dimensioning and tolerancing per ASME Y14.5M.
- This drawing is subject to change without notice.
- Reference JEDEC registration TO-252.

# EXAMPLE BOARD LAYOUT

NDP0003B

TO-252 - 2.55 mm max height

TRANSISTOR OUTLINE



LAND PATTERN EXAMPLE  
EXPOSED METAL SHOWN  
SCALE: 8X

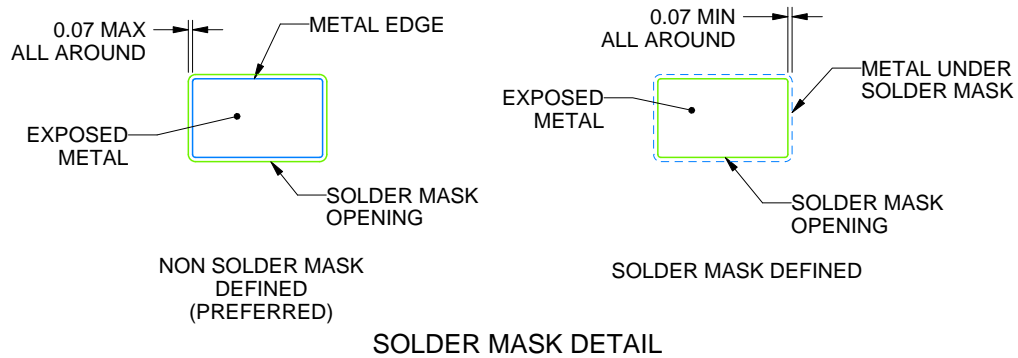

4219870/A 03/2018

NOTES: (continued)

4. This package is designed to be soldered to a thermal pad on the board. For more information, see Texas Instruments literature numbers SLMA002([www.ti.com/lit/slm002](http://www.ti.com/lit/slm002)) and SLMA004 ([www.ti.com/lit/slma004](http://www.ti.com/lit/slma004)).
5. Vias are optional depending on application, refer to device data sheet. It is recommended that vias under paste be filled, plugged or tented.

# EXAMPLE STENCIL DESIGN

NDP0003B

TO-252 - 2.55 mm max height

TRANSISTOR OUTLINE



SOLDER PASTE EXAMPLE  
BASED ON 0.125 MM THICK STENCIL  
SCALE: 8X

4219870/A 03/2018

NOTES: (continued)

6. Laser cutting apertures with trapezoidal walls and rounded corners may offer better paste release. IPC-7525 may have alternate design recommendations.
7. Board assembly site may have different recommendations for stencil design.



## IMPORTANT NOTICE AND DISCLAIMER

TI PROVIDES TECHNICAL AND RELIABILITY DATA (INCLUDING DATASHEETS), DESIGN RESOURCES (INCLUDING REFERENCE DESIGNS), APPLICATION OR OTHER DESIGN ADVICE, WEB TOOLS, SAFETY INFORMATION, AND OTHER RESOURCES "AS IS" AND WITH ALL FAULTS, AND DISCLAIMS ALL WARRANTIES, EXPRESS AND IMPLIED, INCLUDING WITHOUT LIMITATION ANY IMPLIED WARRANTIES OF MERCHANTABILITY, FITNESS FOR A PARTICULAR PURPOSE OR NON-INFRINGEMENT OF THIRD PARTY INTELLECTUAL PROPERTY RIGHTS.

These resources are intended for skilled developers designing with TI products. You are solely responsible for (1) selecting the appropriate TI products for your application, (2) designing, validating and testing your application, and (3) ensuring your application meets applicable standards, and any other safety, security, or other requirements. These resources are subject to change without notice. TI grants you permission to use these resources only for development of an application that uses the TI products described in the resource. Other reproduction and display of these resources is prohibited. No license is granted to any other TI intellectual property right or to any third party intellectual property right. TI disclaims responsibility for, and you will fully indemnify TI and its representatives against, any claims, damages, costs, losses, and liabilities arising out of your use of these resources.

TI's products are provided subject to TI's Terms of Sale ([www.ti.com/legal/termsofsale.html](http://www.ti.com/legal/termsofsale.html)) or other applicable terms available either on [ti.com](http://ti.com) or provided in conjunction with such TI products. TI's provision of these resources does not expand or otherwise alter TI's applicable warranties or warranty disclaimers for TI products.

Mailing Address: Texas Instruments, Post Office Box 655303, Dallas, Texas 75265  
Copyright © 2020, Texas Instruments Incorporated