

● ● ● Price index



UL94-V2 classifications upon request



ESD classification: Electrically conductive ESD/ATEX version upon request



e-tubes with HT-material for hot chips up to 850°C available upon request



To open the e-tube Series R100 lift up the lid and swivel lid to the side



When to use the Series R157/R158:

- If snap-open accessibility along inner or outer radius is required
- If a low-cost, lightweight e-tube for many types of applications required
- If flush attachment is required
- If chip-repellent features are required



When not to use it:

- For extremely chip repellent e-tubes
▶ **System RX, Series RX32, page 6.58**
- If snap-open accessibility along both sides is required
▶ **System E4.1, Series R4.32, page 7.42**
- If very smooth travel due to small pitch is required
▶ **Type R, Series R58, page 6.34**

- ❶ Snap-open lids along inner or outer radius
- ❷ Snap-open from the side, covered pin/bore connection
- ❸ Effective chip protection, even against hot metal chips
- ❹ Double stop dog for strong unsupported length
- ❺ Lateral glide surfaces for side-mounted operation
- ❻ Universal KMA mounting brackets with attachment capability on all sides
- ❼ Space-efficient with optimized ratio of inner dimension to outer dimension
- ❽ **Strain relief separator** - Separator with integrated strain relief for the use in the first or last chain link ▶ **page 6.18**



Order example complete e-tube

Please indicate e-tube-lengths or number of links **Example: 1 m or 22 links**

1 m **157.088.100.0**

e-tube

with 2 separators **1586.01** assembled every 2nd link

Interior separation

1 set **15800.088.12**

Mounting bracket



Unsupported length

FL_G = with straight upper run

FL_B = with permitted sag

Further information ► **Design, page 1.12**

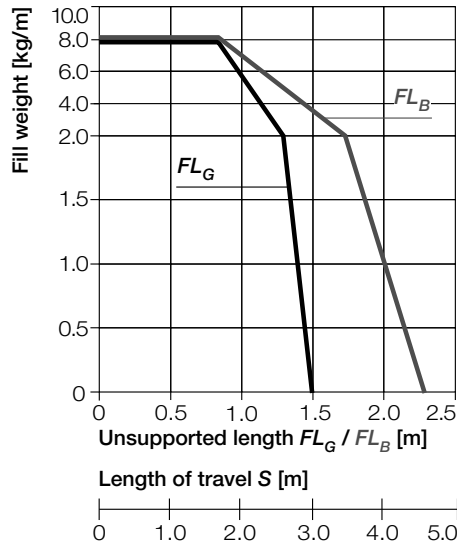
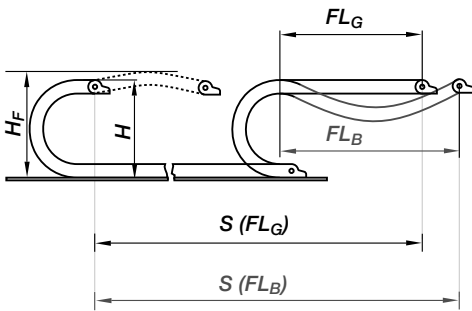

- S = Length of travel
- R = Bending radius
- H = Nominal clearance height
- H_F = Required clearance height
- D = Overlength e-chain® radius in final position
- $K = \pi \cdot R + \text{"safety"}$

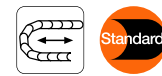
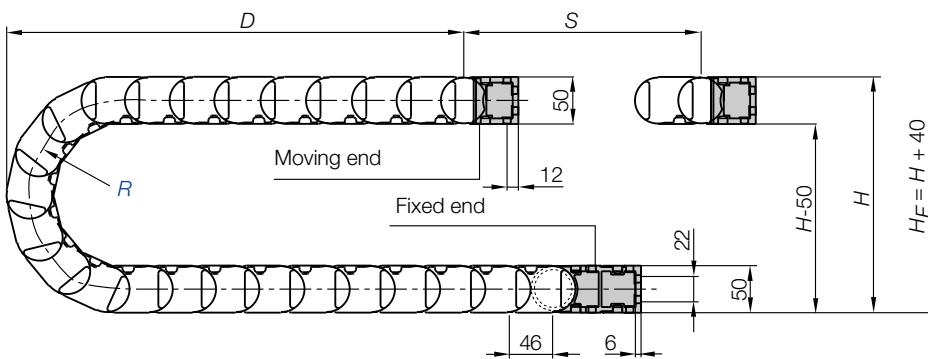

Short travels - unsupported

Unsupported e-chains® feature positive camber over short travels. This must be accounted for when specifying the clearance height H_F . Please consult igus® if space is particularly restricted.

Pitch = 46 mm/link Links/m = 22 (1012 mm) Chain length = $S/2 + K$

R	100	125	150	175	200	250
H	250	300	350	400	450	550
D	194	219	244	269	294	344
K	410	485	565	645	725	880

The required clearance height:
 $H_F = H + 40$ mm
(with 1,0 kg/m fill weight)

Hot Chips up to 850°C

e-tubes that repel hot chips, up to 850 °C. Some applications, depending on amount and size of the chips, can burn or melt the surface. That is no longer the case with the igus® "igumid HT" material.

Order example - Full e-tube made of HT*: 158.100.100.0.HT

Order example - Lids made of HT: 158.100HT.100.0

*for long travels upon request

Delivery time up to 4 weeks! Further Information: www.igus.de/en/HT



Technical Data

Speed / acceleration FL_G	max. 10 [m/s] / max. 100 [m/s ²]
Speed / acceleration FL_B	max. 3 [m/s] / max. 6 [m/s ²]
Gliding speed / acceleration (maximum)	max. 0,5 [m/s] / max. 5 [m/s ²]
Material - permitted temperature °C	igumid G / -40° up to +120° C
Flammability class, igumid G	VDE 0304 IIC UL94 HB



Details of material properties

► page 1.38

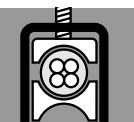

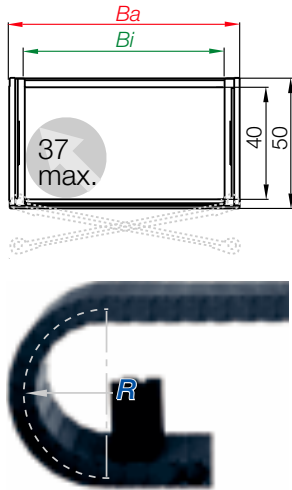

Series R157 - hinged, snap-open on both sides of the inner radius

Part No.	B_i [mm]	B_a [mm]	R [mm]	Bending radii					Weight [kg/m]
157.040.□.0*	40	56	100	125	150	175	200	250	≈ 1,21
157.050.□.0	50	66	100	125	150	175	200	250	≈ 1,30
157.075.□.0	75	91	100	125	150	175	200	250	≈ 1,50
157.088.□.0	88	104	100	125	150	175	200	250	≈ 1,57
157.090.□.0**	88	104	100	125	150	175	200	250	≈ 1,63
157.100.□.0	100	116	100	125	150	175	200	250	≈ 1,71
157.125.□.0	125	141	100	125	150	175	200	250	≈ 1,92
157.135.□.0	135	150	100	125	150	175	200	250	≈ 2,10
157.150.□.0	150	166	100	125	150	175	200	250	≈ 2,13
157.175.□.0	175	191	100	125	150	175	200	250	≈ 2,34
157.200.□.0	200	216	100	125	150	175	200	250	≈ 2,55

* Lid removable only, not hinged

** Same dimensions as 157.088 - less recent design, no hinged option

Supplement Part No. with required radius. Example: 157.100.□100□.0

0 = standard color, other colors ▶ page 1.39 · Pitch = 46 mm/link - Links/m = 22

Part No. structure

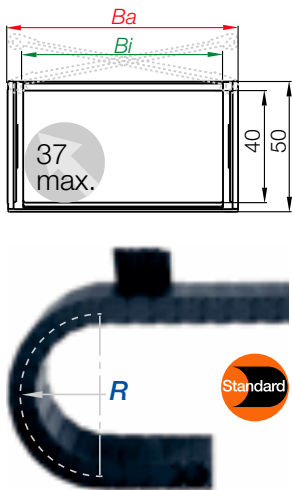
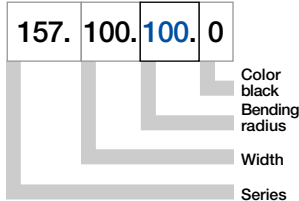

Series R158 - hinged, snap-open on both sides of the outer radius

Part No.	B_i [mm]	B_a [mm]	R [mm]	Bending radii					Weight [kg/m]
158.040.□.0*	40	56	100	125	150	175	200	250	≈ 1,21
158.050.□.0	50	66	100	125	150	175	200	250	≈ 1,30
158.075.□.0	75	91	100	125	150	175	200	250	≈ 1,50
158.088.□.0	88	104	100	125	150	175	200	250	≈ 1,57
158.090.□.0**	88	104	100	125	150	175	200	250	≈ 1,63
158.100.□.0	100	116	100	125	150	175	200	250	≈ 1,71
158.125.□.0	125	141	100	125	150	175	200	250	≈ 1,92
158.135.□.0	135	150	100	125	150	175	200	250	≈ 2,10
158.150.□.0	150	166	100	125	150	175	200	250	≈ 2,13
158.175.□.0	175	191	100	125	150	175	200	250	≈ 2,34
158.200.□.0	200	216	100	125	150	175	200	250	≈ 2,55

* Lid removable only, not hinged

** Same dimensions as 158.088 - less recent design, no hinged option

The size 125 is available upon request. Delivery time: approx. 8-10 weeks after receipt of order

Supplement Part No. with required radius. Example: 158.100.□100□.0

0 = standard color, other colors ▶ page 1.39 · Pitch = 46 mm/link - Links/m = 22

Part No. structure

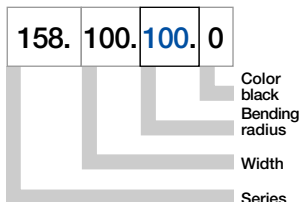

Option 1: Vertical Separators

Vertical Separators are used if a vertical subdivision of the e-chain® interior is required -

By standard Vertical Separators are assembled every other e-chain® link

- **Standard** subdivision with Vertical Separator 1586.01
- **Asymetrical Separator 1586.01.A** for side-mounted operations
- **Strain Relief Separator 1586.01.Z**, integrable in the mounting bracket, to position at any point - can be combined with **Full-Width Shelf 221.X** and **Shelf 2210.X**

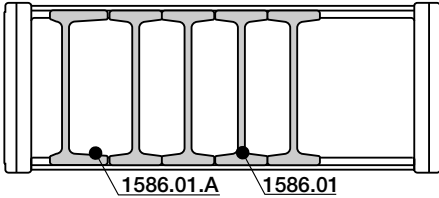

Vertical Separator

unassembled	1585.01
assembled	1586.01

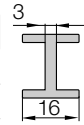

Asymetrical Separator

unassembled	1585.01.A
assembled	1586.01.A

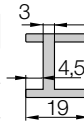

Strain Relief Separator

unassembled	1585.01.Z
assembled	1586.01.Z

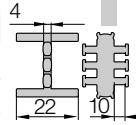

E2 e-tubes Type R
Inner height: 40 mm

Option 2: Full-Width Shelves

For applications involving many thin cables with similar or identical diameters

- Vertical Separator, slotted 1586.02 for applications with Full-Width Shelf 221.X

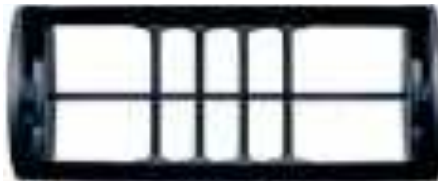
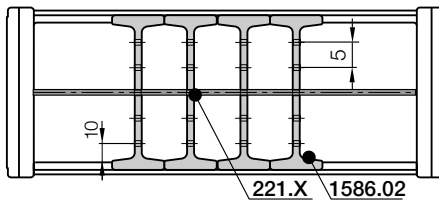

Vert. Separator, slotted

unassembled	1585.02
assembled	1586.02

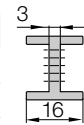

Width X [mm]	Part No. unassembled	Part No. assembled
040	220.40	221.40
050	220.50	221.50
075	220.75	221.75
088	220.87	221.87
100	220.100	221.100

Width X [mm]	Part No. unassembled	Part No. assembled
125	220.125	221.125
135	220.135	221.135
150	220.150	221.150
175	220.175	221.175
200	220.200	221.200

Full-Width Shelf

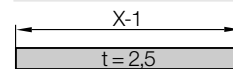

Option 3: Shelves

For applications involving many cables with similar or identical diameters. Partial separation into individual chambers can be achieved and the entire width B_i-10 mm can be used

- Shelf 2210.X can be combined with Middle Plate 1586.03

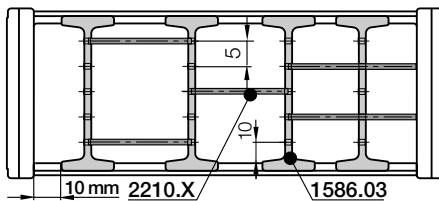

Middle Plate

unassembled	1585.03
assembled	1586.03

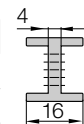

Width X [mm]	Part No. unassembled	Part No. assembled
018	2200.18	2210.18
023	2200.23	2210.23
028	2200.28	2210.28
033	2200.33	2210.33
038	2200.38	2210.38
043	2200.43	2210.43
048	2200.48	2210.48

Width X [mm]	Part No. unassembled	Part No. assembled
058	2200.58	2210.58
068	2200.68	2210.68
073	2200.73	2210.73
088	2200.88	2210.88
099	2200.99	2210.99
124	2200.124	2210.124
149	2200.149	2210.149

Shelf

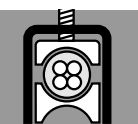
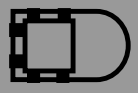
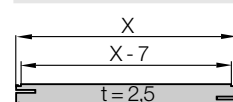

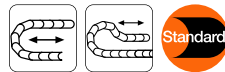

Option KMA* - pivoting, extended

- Recommended for unsupported and gliding applications
- Extended, pivoting
- Easy to install
- Universally mountable with attachment capability on all sides
- Locked connection to e-tube
- Long travels with lowered mounting height possible

*KMA = Polymer Metal Mounting Bracket

Moving end (outer link)
15800/15801 ...1

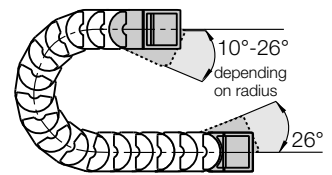

15800/15801...2
Fixed end (inner link)

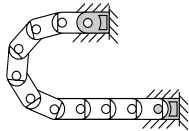

The attachment variants arising automatically by the choice of the KMA mounting bracket

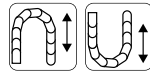

Option KMA - locking, extended

- Recommended for vertical hanging / standing applications
- Extended, locking
- Easy to install
- Flush mounting at both ends of the e-tube
- Universally mountable with attachment capability on all sides
- Corrosion-resistant

Moving end (outer link)
15800/15801 ...3

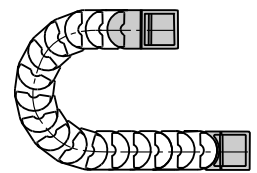

15800/15801...4
Fixed end (inner link)

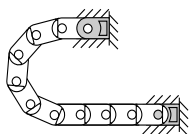

The attachment variants arising automatically by the choice of the KMA mounting bracket

Dimensions and order configurations



Quickflange upon request

Part No. structure (pivoting)

15800.100.12.A

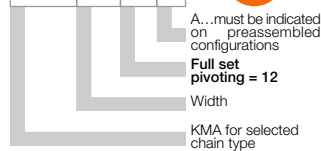

Full set, for both ends:

15800.100.12

Single-part order:

15800.100.1

Mounting bracket with bore

15800.100.2

Mounting bracket with pin

Part No. structure (locking)

15800.100.34.A

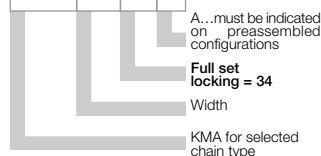

Full set, for both ends:

15800.100.34

Single-part order:

15800.100.3

Mounting bracket with bore

15800.100.4

Mounting bracket with pin

15800/15801...1 Standard! (pivoting)

15800/15801...3 (locking)

Moving end

Standard! (pivoting) 15800/15801...2
(locking) 15800/15801...4

Fixed end

Quickflange available upon request

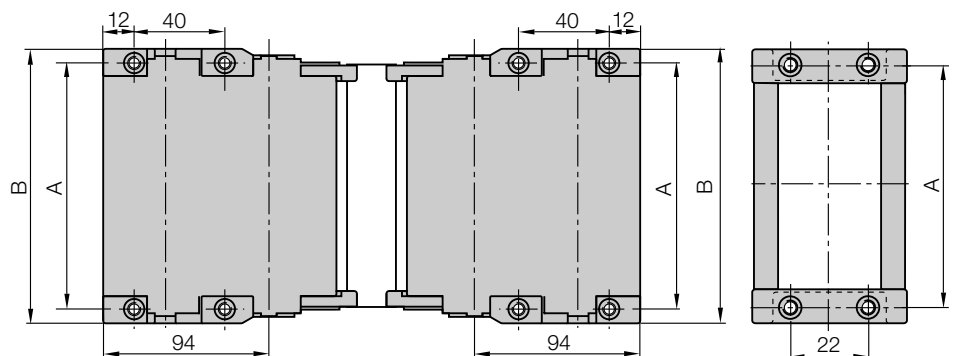

For Series	Part No. full set	Dim. A [mm]	Dim. B [mm]
157-158.040 ▶	15801.040. <input type="text"/>	50	61
157-158.050 ▶	15800.050. <input type="text"/>	60	71
157-158.075 ▶	15800.075. <input type="text"/>	85	96
157-158.088 ▶	15800.088. <input type="text"/>	98	109
157-158.090 ▶	15801.090. <input type="text"/>	98	109
157-158.100 ▶	15800.100. <input type="text"/>	110	121
157-158.125 ▶	15800.125. <input type="text"/>	135	146
157-158.135 ▶	15800.135. <input type="text"/>	145	156
157-158.150 ▶	15800.150. <input type="text"/>	160	171
157-158.175 ▶	15800.175. <input type="text"/>	185	196
157-158.200 ▶	15800.200. <input type="text"/>	210	221

Please add the Part No. with the requested index - 12 for the pivoting configuration

e.g. 15800.100.12 or 34 for the locking configuration e.g. 15800.100.34

For the preassembled mode please add the index A e.g. 15800.100.12.A

The following parts are required for attachment of the mounting brackets:

- Socket head cap bolt M5 DIN 912-8.8 Length depends on the thickness of the attachment base
- Washer 5,3 DIN 125-ST ● Hexagon nut M5 DIN 934-8



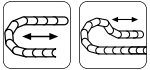

Option KMA* - pivoting, abbreviated

- Recommended for unsupported and gliding applications
- Abbreviated, pivoting
- Universally mountable with attachment capability on all sides
- Locked connection to e-tube
- Corrosion-resistant
- Space-restricted
- Long travels with lowered mounting height possible

*KMA = Polymer Metal Mounting Bracket

Moving end (outer link)

1580...1

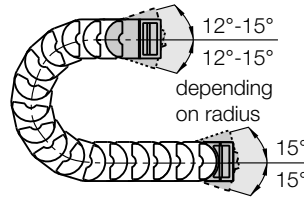

1580...2

Fixed end (inner link)



The attachment variants arising automatically by the choice of the KMA mounting bracket

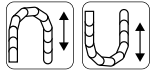
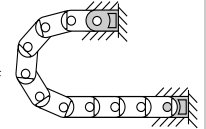

Option KMA - locking, abbreviated

- Recommended for vertical hanging / standing applications
- Abbreviated, locking
- Flush mounting at both ends of the e-tube
- Corrosion-resistant
- Flush mounting, turned 90° at fixed end option

Moving end (outer link)

1585...1

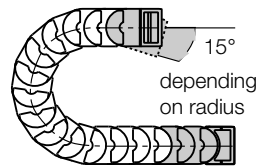

1585...2

Fixed end (inner link)



The attachment variants arising automatically by the choice of the KMA mounting bracket

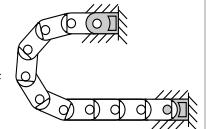

1580...1 (pivoting)

(pivoting) 1580...2

Quickflange available upon request

1585...1 (locking)

(locking) 1585...2

Moving end

Fixed end

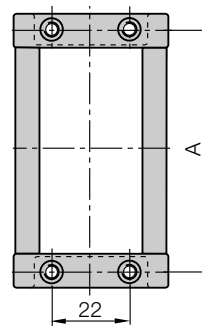
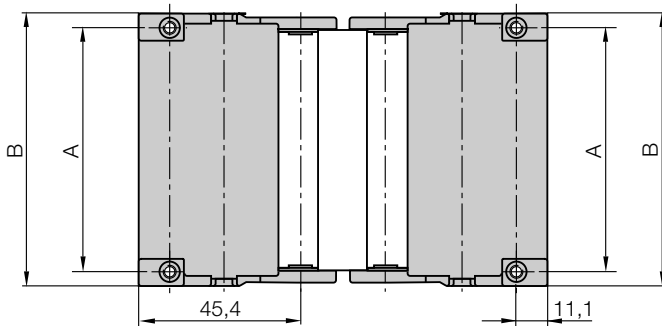

Dimensions and order configurations



Quickflange upon request

Part No. structure (pivoting)

1580.040.12 A

A... must be indicated on preassembled configurations

Full set

Width

KMA pivoting for selected chain type

Full set, for both ends:

1580.040.12

Single-part order:

1580.040.1

Mounting bracket with bore

1580.040.2

Mounting bracket with pin

Part No. structure (locking)

1585.040.12 A

A... must be indicated on preassembled configurations

Full set

Width

KMA locking for selected chain type

Full set, for both ends:

1585.040.12

Single-part order:

1585.040.1

Mounting bracket with bore

1585.040.2

Mounting bracket with pin

For Series	Part No. full set	Dim. A [mm]	Dim. B [mm]
157-158.040 ▶	.040.12	50	61
157-158.050 ▶	.050.12	60	71
157-158.075 ▶	.075.12	85	96
157-158.088 ▶	.088.12	98	109
157-158.090 ▶	.090.12	98	109
157-158.100 ▶	.100.12	110	121
157-158.125 ▶	.125.12	135	146
157-158.135 ▶	.135.12	145	156
157-158.150 ▶	.150.12	160	171
157-158.175 ▶	.175.12	185	196
157-158.200 ▶	.200.12	210	221

Please add the Part No. with the requested index - 1580 for the pivoting configuration

e.g. 1580.100.12 or 1585 for the locking configuration e.g. 1585.100.12

For the preassembled mode please add the index [A] e.g. 1580.100.12 [A]

The following parts are required for attachment of the mounting brackets:

- Socket head cap bolt M5 DIN 912-8.8 Length depends on the thickness of the attachment base
- Washer 5,3 DIN 125-ST ● Hexagon nut M5 DIN 934-8



Strain relief separator for the use in the first or last chain link ▶ page 6.18

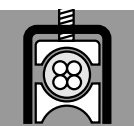

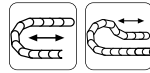

Flange mounting brackets made of steel

- Metallic flange brackets with popular hole patterns, easily be replaced by their modern successors, without having to alter the hole pattern
- Bolted connection outside of chain cross-section possible
- Universally mountable with attachment capability on all sides
- Steel, galvanized
- One-piece mounting bracket
- High stability

Moving end (outer link)
906.461.X

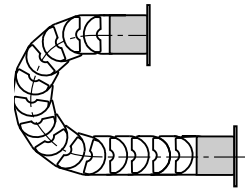

906.461.X

Fixed end (inner link)

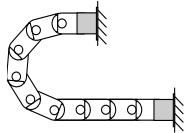

Flush mounting possibilities
at both ends of the e-tube

Dimensions and order configurations

Hole patterns flange steel
mounting brackets 906.461.X

906.461.X
Moving end

906.461.X
Fixed end

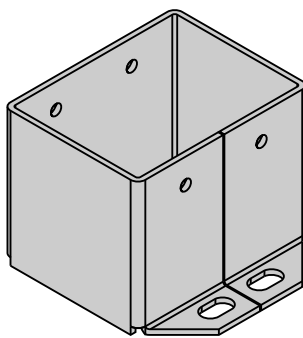

Principle sketch flange
steel mounting brackets

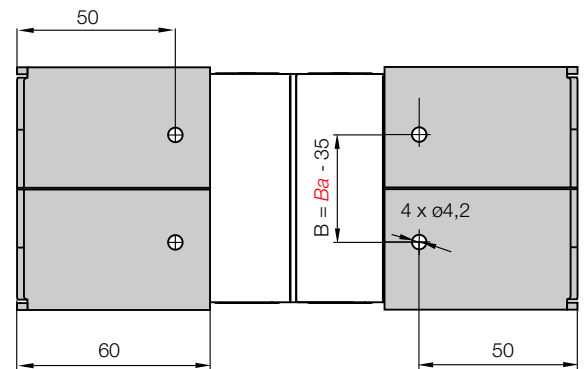
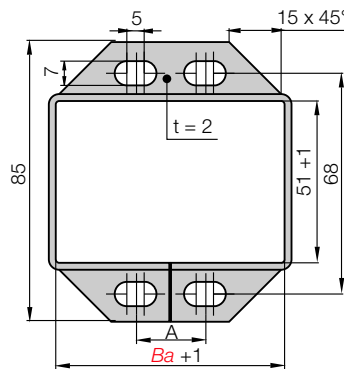

For Series	Hole pattern	Part No. full set	Bi [mm]	Ba [mm]	Dim. A [mm]	Dim. B [mm]
157-158.050	▶ 58.05	906.461.1	50	66	20	31
157-158.075	▶ 58.1	906.461.2	75	91	30	57



Mounting only with hexagon socket DIN 912 M6 and washer DIN 125, 6,3 mm

Phone +49- (0) 22 03-96 49-800
Fax +49- (0) 22 03-96 49-222

igus® GmbH
51147 Cologne

Internet: www.igus.eu
E-mail: info@igus.de

R100 | Series R157·R158 | Accessories | Strain Relief

Strain relief separator

Separator with integrated strain relief, for use in the first or last chain link. For manufacturing of switchgear cabinets or for the assembly of machines. Easy to assemble without any fastening device. Separator base 1585.01.Z is 22 mm wide. The possible number of separators per e-chain® is defined by its inner width B_i and by the cable-diameter. **Details ▶ chapter 10**

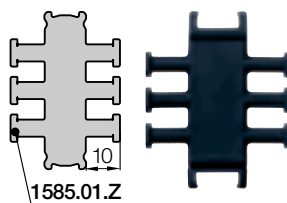

Part No.	Number of teeth	For Series
1585.01.Z	3 both sides	R157/158 e-tube



Other strain relief elements
▶ chapter 10

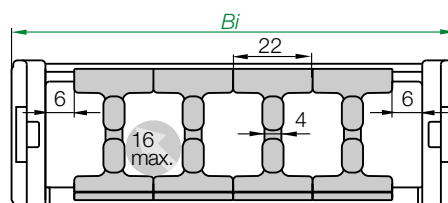

Strain Relief Separator - The number of separators is depending on the cables and the available inner space. Example: e-chain® inner width B_i 100 mm: 4 Strain Relief Separator, max. cable diameter 16 mm.

Details ▶ chapter 10



E2 e-tubes Type R
Inner height: 40 mm



igus® e-tubes Series R100
in a medical application

Phone +49- (0) 22 03-96 49-800
Fax +49- (0) 22 03-96 49-222



▶ chapter 10



▶ page 6.5