

Leiterplatten-Layout Vorschlag für SMT
PCB-Layout Proposal for SMT

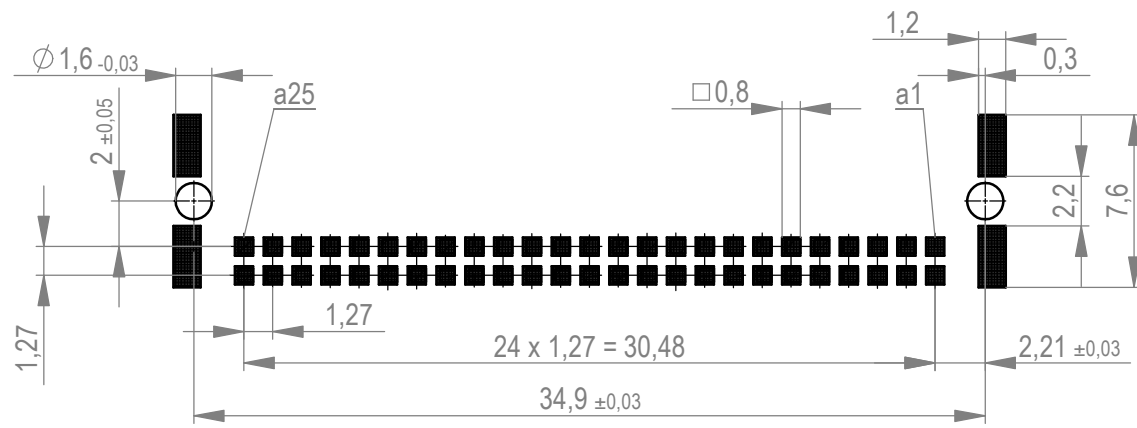

Verpackt im Gurt in Anlehnung an DIN IEC 60286-3
tape on reel packaging according to DIN IEC 60286-3
Verpackungseinheit: 560 Stück
packaging unit: 560 pcs

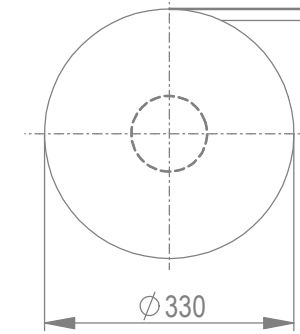

Abspulrichtung - reel off direction

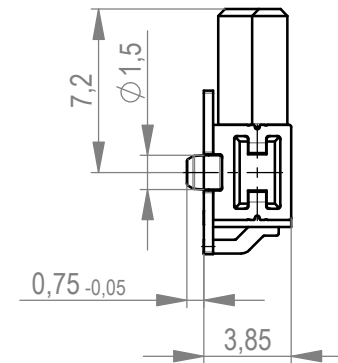
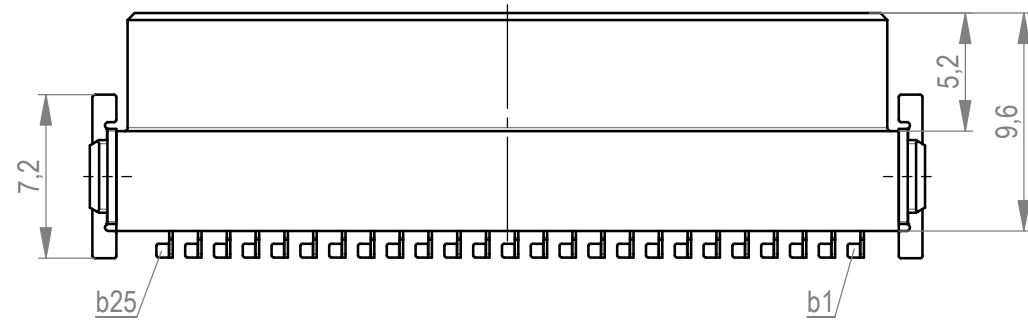
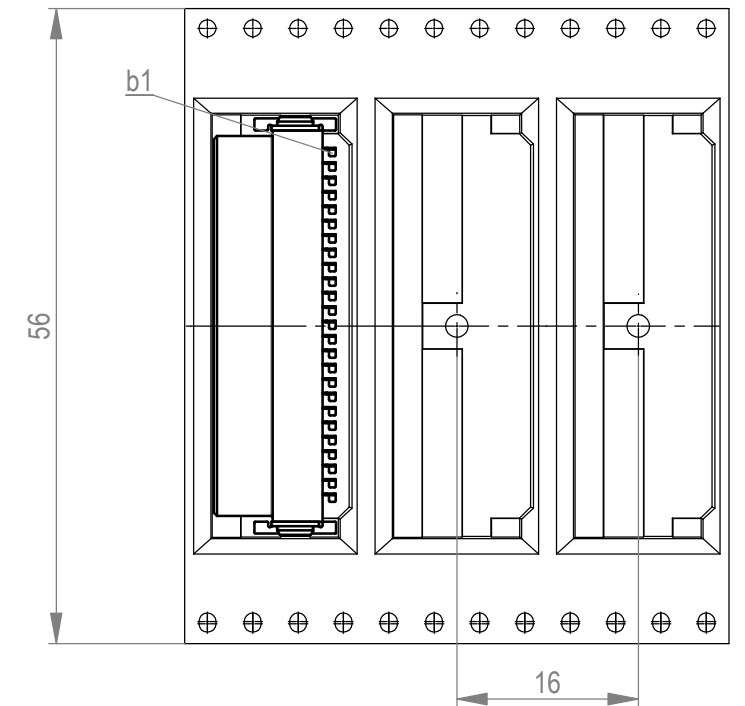

Anforderungsstufe 1
performance level 1

Kontaktbereich vergoldet
mating area gold plating

Anschlussbereich verzinkt 4-6 μm
terminal area 4-6 μm tin plating

Koplanarität der Anschlüsse $\leq 0,1 \text{ mm}$
coplanarity area of termination $\leq 0,1 \text{ mm}$

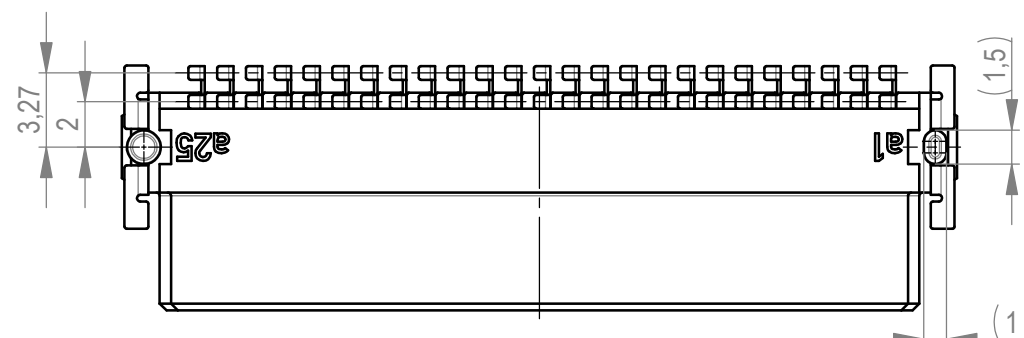
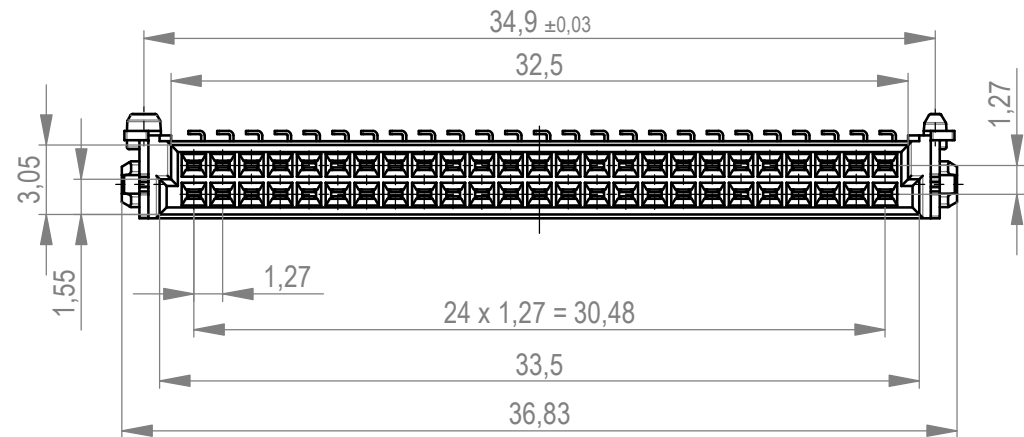

BA7-03 - Standard Bauhöhe
type7-03 - Standard Assembly Height

Weitergabe sowie Vervielfältigung dieses Dokuments, Verwertung und Mitteilung seines Inhalts sind verboten, soweit nicht ausdrücklich gestattet. Zuwiderhandlungen verpflichten zu Schadenersatz. Alle Rechte für den Fall der Patent-, Gebrauchsmuster- oder Geschmacksunterstützung vorbehalten. The reproduction, distribution and utilization of this document as well as the communication of its contents to others without express authorization is prohibited. Offenders will be held liable for the payment of damages. All rights reserved in the event of a patent, utility model or design.

Die deutsche Version dieser Zeichnung dient nur zur Erleichterung der Handhabung. Bei Abweichungen von dem englischen Original gilt das englische Original. The german version of this drawing has been offered for convenience only and may deviate from the english original. In case of any deviation the English version shall prevail.

Dimension no.	Tolerances		Scale	5:1
	ISO 8015	All Dimensions in mm	Material	
Customer drawing:	Subject to modification without prior notice. Drawing will not be updated.		Federl. SMC-Q 50-SMD-BA7-03 Female SMC-Q 50-SMD-type7-03	
All rights reserved. Only for Information. To ensure that this is the latest version of this drawing, please contact one of the ERNI companies before using.			154742	
h	04.02.2020	ERNI International AG Zürichstrasse 72 8306 Brüttisellen - Zürich Switzerland	Class	SMCQ
Index	Date			I A3