



TELECOM EQUIPMENT PROTECTION: TRISIL™

FEATURES

- Bidirectional crowbar protection
- Voltage range from 8V to 262V
- Low capacitance from 30 pF to 45pF typ @ 50V
- Low leakage current : $I_R = 2 \mu\text{A max}$
- Holding current: $I_H = 150 \text{ mA min}$
- Repetitive peak pulse current :
 $I_{PP} = 100 \text{ A (10/1000}\mu\text{s)}$

MAIN APPLICATIONS

Any sensitive equipment requiring protection against lightning strikes and power crossing:

- Analog and digital line cards (xDSL, T1/ E1, ISDN...)
- Terminals (phone, fax, modem...) and central of-
fice equipment

DESCRIPTION

The SMP100LC-xxx series is a low capacitance transient surge arrester designed for the protection of high debit rate communication equipment. Its low capacitance avoids any distortion of the signal and is compatible with digital line cards (xDSL, T1/E1, ISDN...).

BENEFITS

Trisils are not subject to ageing and provide a fail safe mode in short circuit for a better protection. They are used to help equipment to meet main standards such as UL1950, IEC950 / CSA C22.2 and UL1459. They have UL94 V0 approved resin. SMB package is JEDEC registered (DO-214AA). Trisils are UL497B approved (file: E136224) and comply with the following standards GR-1089 Core, ITU-T-K20/K21, VDE0433, VDE0878, IEC61000-4-5 and FCC part 68.

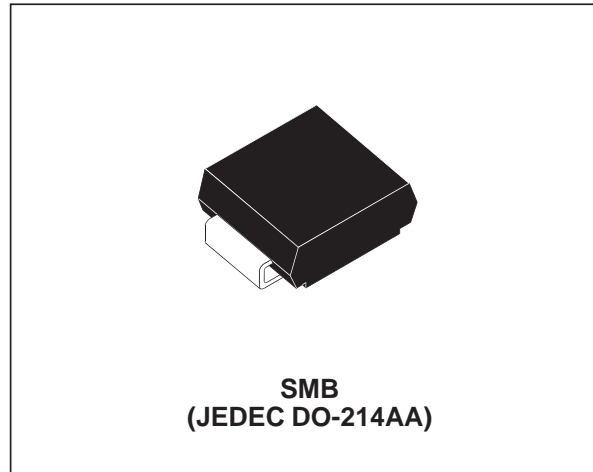

SCHEMATIC DIAGRAM

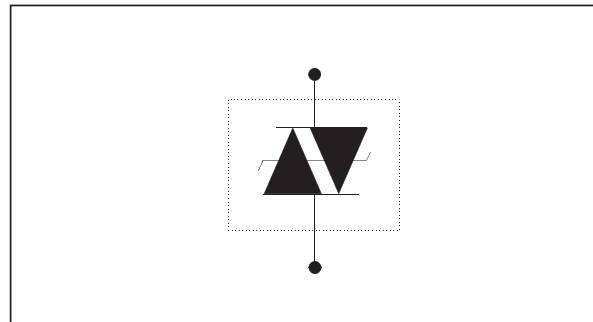

IN COMPLIANCES WITH THE FOLLOWING STANDARDS

STANDARD	Peak Surge Voltage (V)	Voltage Waveform	Required peak current (A)	Current waveform	Minimum serial resistor to meet standard (Ω)
GR-1089 Core First level	2500 1000	2/10 μ s 10/1000 μ s	500 100	2/10 μ s 10/1000 μ s	0 0
GR-1089 Core Second level	5000	2/10 μ s	500	2/10 μ s	0
GR-1089 Core Intra-building	1500	2/10 μ s	100	2/10 μ s	0
ITU-T-K20/K21	6000 1500	10/700 μ s	150 37.5	5/310 μ s	0 0
ITU-T-K20 (IEC61000-4-2)	8000 15000	1/60 ns	ESD contact discharge ESD air discharge		0 0
VDE0433	4000 2000	10/700 μ s	100 50	5/310 μ s	0 0
VDE0878	4000 2000	1.2/50 μ s	100 50	1/20 μ s	0 0
IEC61000-4-5	4000 4000	10/700 μ s 1.2/50 μ s	100 100	5/310 μ s 8/20 μ s	0 0
FCC Part 68, lightning surge type A	1500 800	10/160 μ s 10/560 μ s	200 100	10/160 μ s 10/560 μ s	0 0
FCC Part 68, lightning surge type B	1000	9/20 μ s	25	5/320 μ s	0

THERMAL RESISTANCES

Symbol	Parameter	Value	Unit
$R_{th(j-a)}$	Junction to ambient with recommended footprint	100	$^{\circ}\text{C/W}$
$R_{th(j-l)}$	Junction to leads	20	$^{\circ}\text{C/W}$

ELECTRICAL CHARACTERISTICS ($T_{amb} = 25^{\circ}\text{C}$)

Symbol	Parameter
V_{RM}	Stand-off voltage
I_{RM}	Leakage current at V_{RM}
V_R	Continuous reverse voltage
I_R	Leakage current at V_R
V_{BR}	Breakdown voltage
V_{BO}	Breakover voltage
I_H	Holding current
I_{BO}	Breakover current
I_{PP}	Peak pulse current
C	Capacitance

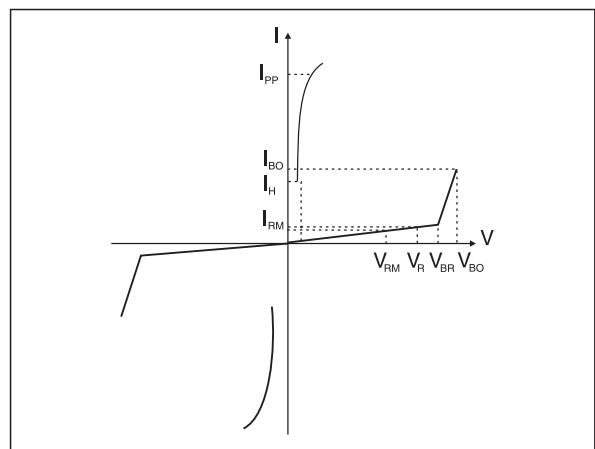

ABSOLUTE RATINGS ($T_{amb} = 25^{\circ}C$)

Symbol	Parameter	Value	Unit	
I_{pp}	Repetitive peak pulse current:	10/1000 μs	100	A
		8/20 μs	250	
		10/560 μs	120	
		5/310 μs	150	
		10/160 μs	200	
		1/20 μs	250	
		2/10 μs	500	
		I_{FS}	Fail-safe mode : maximum current (note 1)	
I_{TSM}	Non repetitive surge peak on-state current (Sinusoidal)	t = 20ms	55	A
		t = 16.6ms	60	
		t = 0.2s	25	
		t = 2s	12	
I^2t	I^2t value for fusing	t = 16.6ms t = 20ms	30	A ² s
T_L	Maximum lead temperature for soldering during 10s		260	$^{\circ}C$
T_{stg} T_j	Storage temperature range		- 55 to + 150	$^{\circ}C$
	Maximum junction temperature		150	$^{\circ}C$

Note 1: in fail safe mode, the device acts as a short circuit.

Repetitive peak pulse current

tr: rise time (μs)

tp: pulse duration time (μs)

ex: Pulse waveform 10/1000 μs

tr = 10 μs tp = 1000 μs

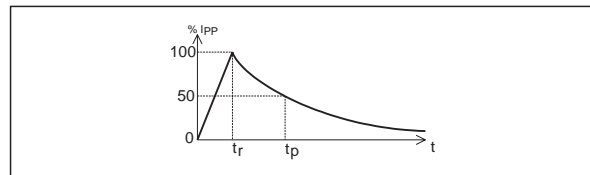

ELECTRICAL PARAMETERS ($T_{amb} = 25^{\circ}C$)

Type	$I_{RM} @ V_{RM}$ max.		$I_R @ V_R$ max. Note 1		Dynamic $V_{BO} @ I_{BO}$ max. max Note 2		Static $V_{BO} @ I_{BO}$ max. max Note 3		I_H min. Note 4	C typ. Note 5	C typ. Note 6
	μA	V	μA	V	V	mA	V	mA	mA	pF	pF
SMP100LC-8	2	6	50	8	25	800	15	800	50 (typ)	NA	75
SMP100LC-25		22		25	40		35		150	NA	65
SMP100LC-35		32		35	55		55		150	NA	55
SMP100LC-65		55		65	85		85		150	45	90
SMP100LC-90		81		90	120		125		150	40	80
SMP100LC-120		108		120	155		160		150	35	75
SMP100LC-140		120		140	185		190		150	30	65
SMP100LC-160		144		160	210		220		150	30	65
SMP100LC-200		170		200	265		275		150	30	60
SMP100LC-230		200		230	300		320		150	30	60
SMP100LC-270		230		262	350		370		150	30	60

Note 1: I_R measured at V_R guarantee $V_{BR} min \geq V_R$

Note 2: See functional test circuit 1

Note 3: See test circuit 2

Note 4: See functional holding current test circuit 3

Note 5: $V_R = 50V$ bias, $V_{RMS} = 1V$, $F = 1MHz$

Note 6: $V_R = 2V$ bias, $V_{RMS} = 1V$, $F = 1MHz$



Fig. 1: Non repetitive surge peak on-state current versus overload duration (T_j initial = 25 °C).

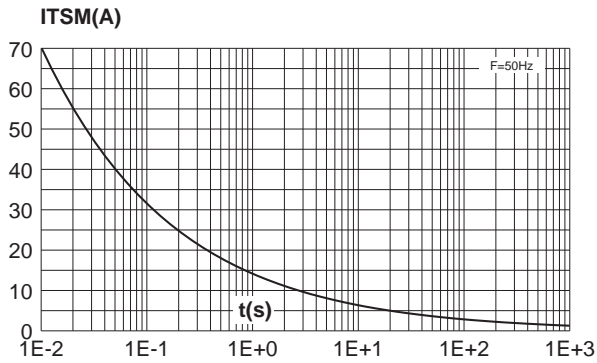

Fig. 2: On-state voltage versus on-state current (typical values)

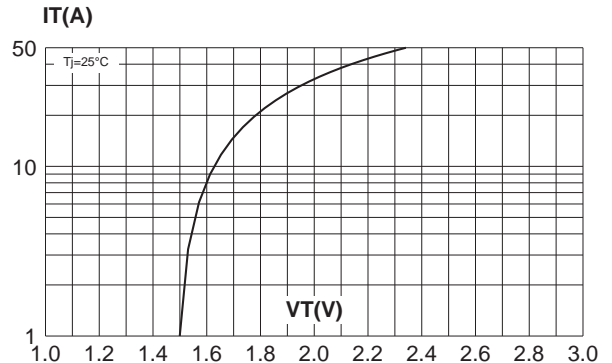

Fig. 3: Relative variation of holding current versus junction temperature .

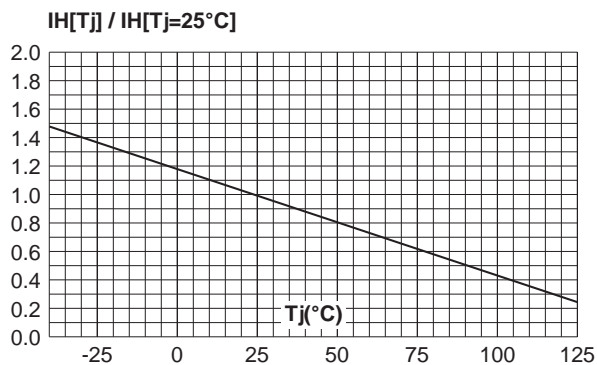

Fig. 4: Relative variation of breakover voltage versus junction temperature.

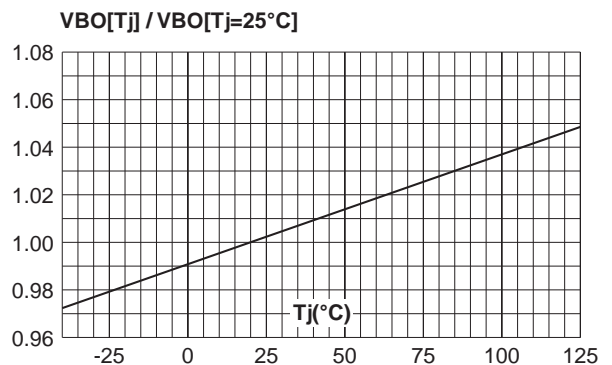

Fig. 5: Relative variation of leakage current versus junction temperature (typical values).

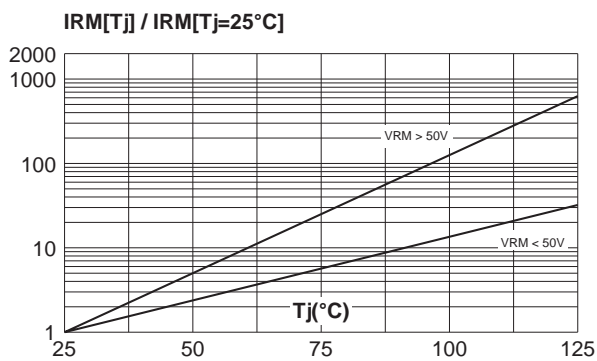

Fig. 6: Variation of thermal impedance junction to ambient versus pulse duration (Printed circuit board FR4, SCu=35µm, recommended pad layout).

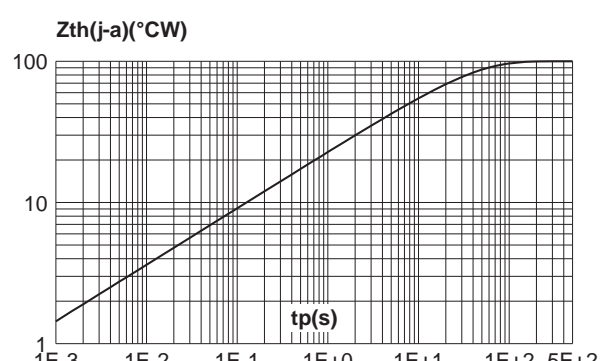
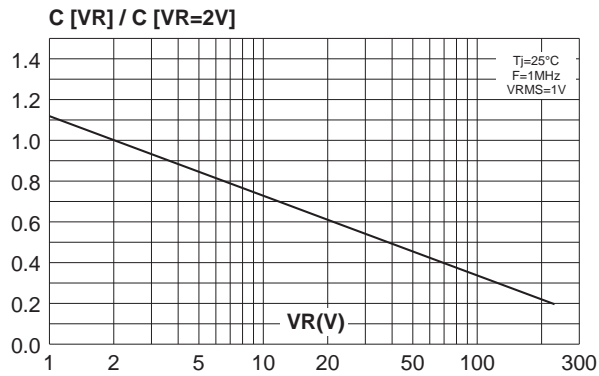
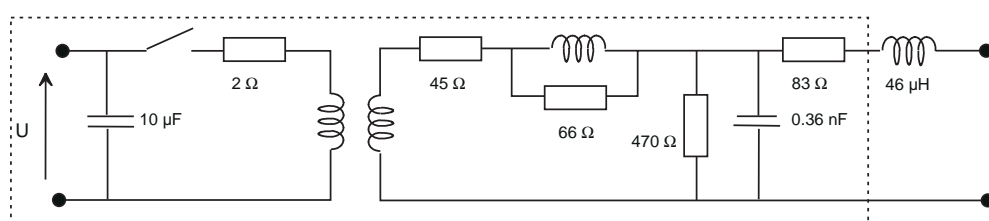

Fig. 7: Relative variation of junction capacitance versus reverse voltage applied (typical values).



TEST CIRCUIT 1 FOR DYNAMIC I_{B0} AND V_{B0} PARAMETERS

100 V / μs , $di/dt < 10 \text{ A} / \mu\text{s}$, $I_{pp} = 100 \text{ A}$



KeyTek 'System 2' generator with PN246I module

1 kV / μs , $di/dt < 10 \text{ A} / \mu\text{s}$, $I_{pp} = 10 \text{ A}$

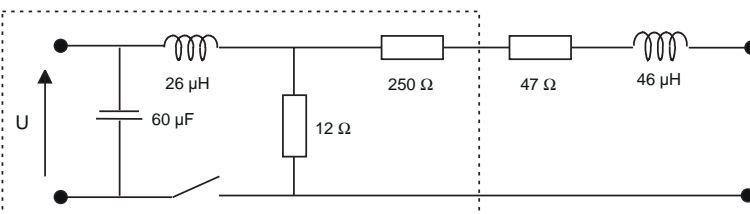

KeyTek 'System 2' generator with PN246I module

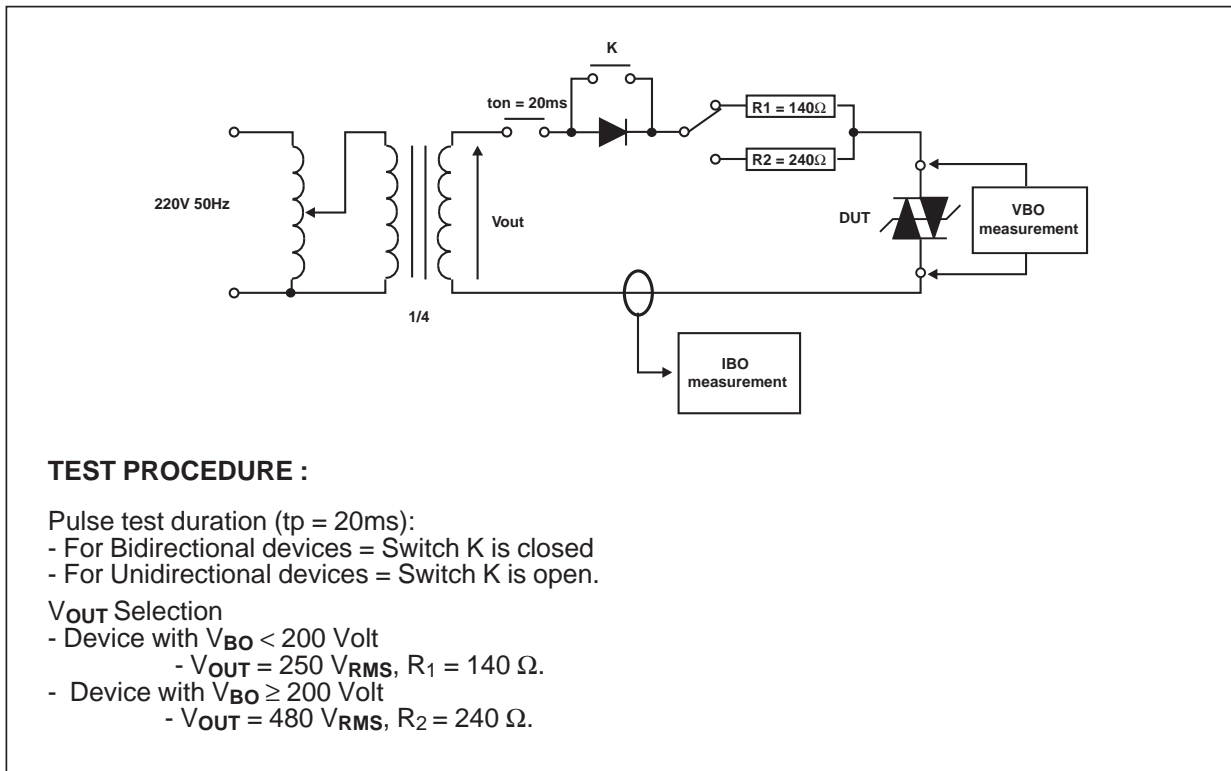
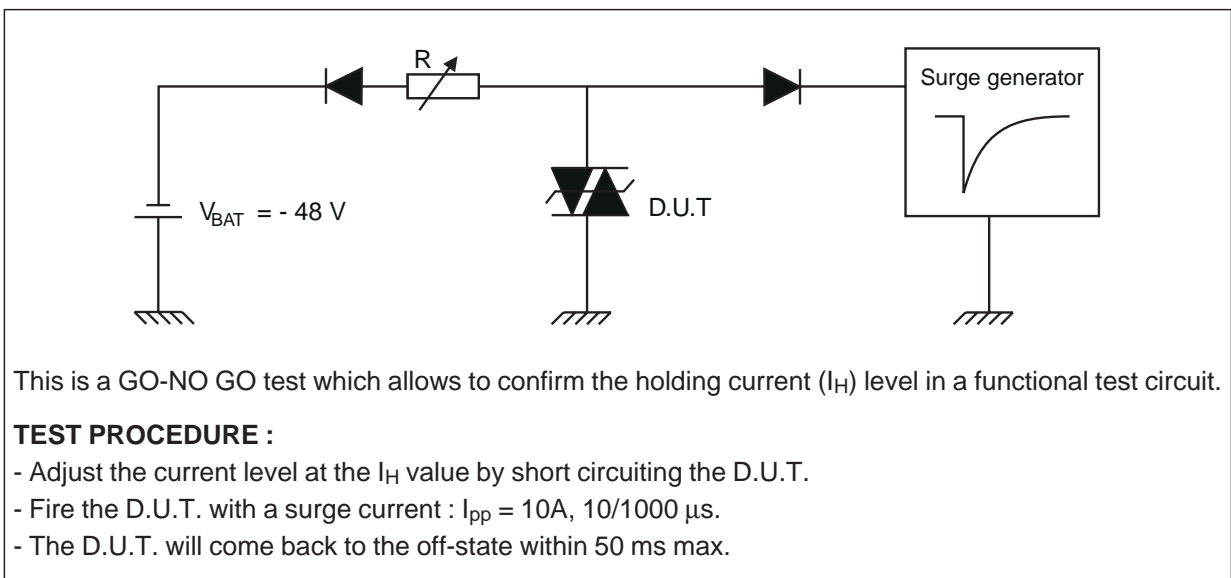
TEST CIRCUIT 2 FOR I_{BO} and V_{BO} parameters :**TEST CIRCUIT 3 FOR I_H PARAMETER**

PACKAGE MECHANICAL DATA
SMB (Plastic)

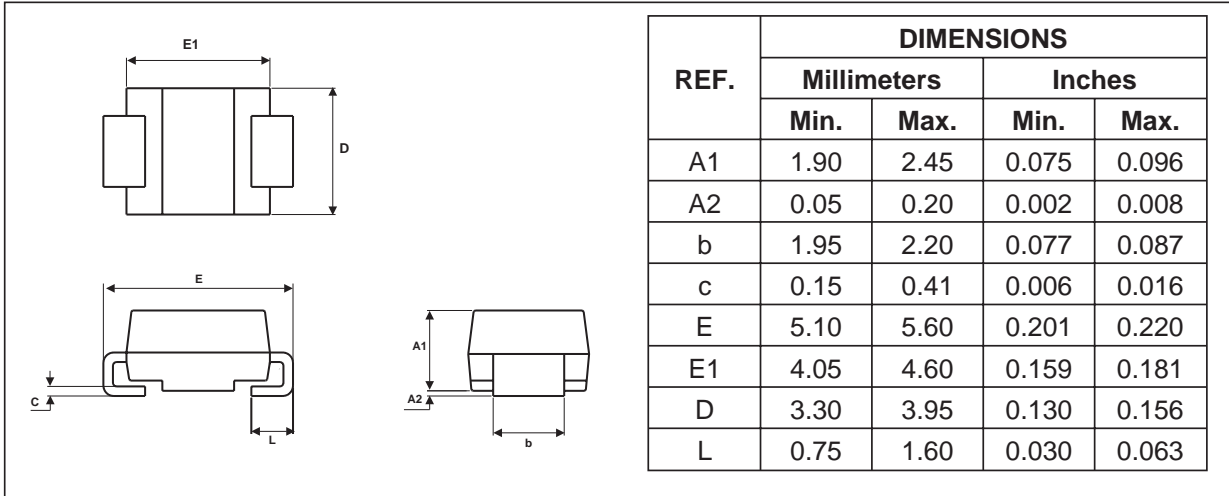

FOOT PRINT in millimeters (inches)

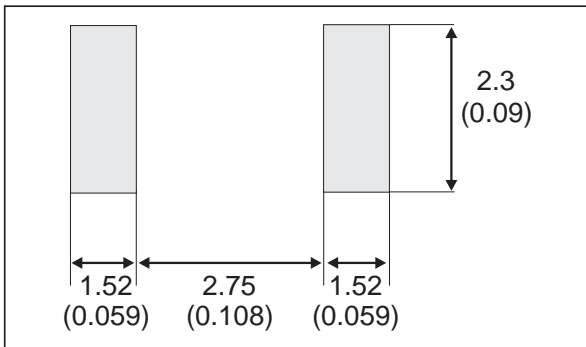

ORDER CODE

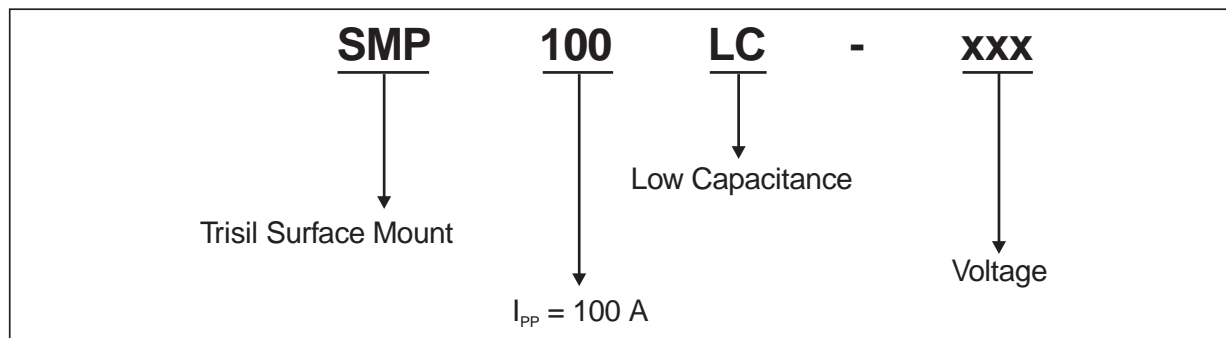

Ordering type	Marking	Package	Weight	Base qty	Delivery mode
SMP100LC-8	PL8	SMB	0.11g	2500	Tape & Reel
SMP100LC-25	L25				
SMP100LC-35	L35				
SMP100LC-65	L06				
SMP100LC-90	L09				
SMP100LC-120	L12				
SMP100LC-140	L14				
SMP100LC-160	L16				
SMP100LC-200	L20				
SMP100LC-230	L23				
SMP100LC-270	L27				

Information furnished is believed to be accurate and reliable. However, STMicroelectronics assumes no responsibility for the consequences of use of such information nor for any infringement of patents or other rights of third parties which may result from its use. No license is granted by implication or otherwise under any patent or patent rights of STMicroelectronics. Specifications mentioned in this publication are subject to change without notice. This publication supersedes and replaces all information previously supplied. STMicroelectronics products are not authorized for use as critical components in life support devices or systems without express written approval of STMicroelectronics.

The ST logo is a registered trademark of STMicroelectronics

© 2002 STMicroelectronics - Printed in Italy - All rights reserved.

STMicroelectronics GROUP OF COMPANIES

Australia - Brazil - Canada - China - Finland - France - Germany
 Hong Kong - India - Israel - Italy - Japan - Malaysia - Malta - Morocco - Singapore
 Spain - Sweden - Switzerland - United Kingdom - United States.

<http://www.st.com>