

LM4862 Boomer® Audio Power Amplifier Series **675 mW Audio Power Amplifier with Shutdown Mode**

Check for Samples: [LM4862](#)

FEATURES

- **No Output Coupling Capacitors, Bootstrap Capacitors or Snubber Circuits are Necessary**
- **Small Outline or PDIP Packaging**
- **Unity-Gain Stable**
- **External Gain Configuration Capability**
- **Pin Compatible with LM4861**

APPLICATIONS

- **Portable Computers**
- **Cellular Phones**
- **Toys and Games**

KEY SPECIFICATIONS

- **THD+N for 500mW Continuous Average Output Power at 1kHz into 8Ω 1% (max)**
- **Output Power at 10% THD+N at 1kHz into 8Ω 825 mW (typ)**
- **Shutdown Current 0.7μA (typ)**

Typical Application

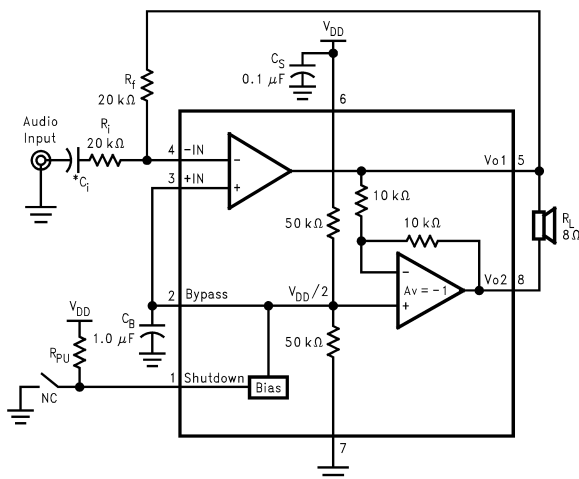

*Refer to [Application Information](#) for information concerning proper selection of the input coupling capacitor.

Figure 1. Typical Audio Amplifier Application Circuit

DESCRIPTION

The LM4862 is a bridge-connected audio power amplifier capable of delivering typically 675mW of continuous average power to an 8Ω load with 1% THD+N from a 5V power supply.

Boomer audio power amplifiers were designed specifically to provide high quality output power with a minimal amount of external components. Since the LM4862 does not require output coupling capacitors, bootstrap capacitors, or snubber networks, it is optimally suited for low-power portable systems.

The LM4862 features an externally controlled, low-power consumption shutdown mode, as well as an internal thermal shutdown protection mechanism.

The unity-gain stable LM4862 can be configured by external gain-setting resistors.

Connection Diagram

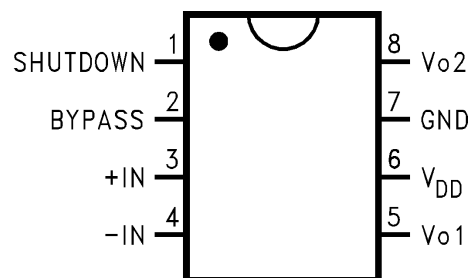

Figure 2. Small Outline and PDIP Package-Top View
See Package Number D0008A or P0008E



Please be aware that an important notice concerning availability, standard warranty, and use in critical applications of Texas Instruments semiconductor products and disclaimers thereto appears at the end of this data sheet.

All trademarks are the property of their respective owners.



These devices have limited built-in ESD protection. The leads should be shorted together or the device placed in conductive foam during storage or handling to prevent electrostatic damage to the MOS gates.

Absolute Maximum Ratings⁽¹⁾⁽²⁾

Supply Voltage		6.0V	
Storage Temperature		-65°C to +150°C	
Input Voltage		-0.3V to $V_{DD} + 0.3V$	
Power Dissipation ⁽³⁾		Internally limited	
ESD Susceptibility ⁽⁴⁾		2000V	
ESD Susceptibility ⁽⁵⁾		200V	
Junction Temperature		150°C	
Soldering Information	Small Outline Package	Vapor Phase (60 sec.)	215°C
		Infrared (15 sec.)	220°C
Thermal Resistance		θ_{JC} (typ)—D0008A	35°C/W
		θ_{JA} (typ)—D0008A	170°C/W
		θ_{JC} (typ)—P0008E	37°C/W
		θ_{JA} (typ)—P0008E	107°C/W

- (1) Absolute Maximum Ratings indicate limits beyond which damage to the device may occur. Operating Ratings indicate conditions for which the device is functional, but do not ensure specific performance limits. Electrical Characteristics state DC and AC electrical specifications under particular test conditions which ensure specific performance limits. This assumes that the device is within the Operating Ratings. Specifications are not ensured for parameters where no limit is given, however, the typical value is a good indication of device performance.
- (2) If Military/Aerospace specified devices are required, please contact the Texas Instruments Sales Office/ Distributors for availability and specifications
- (3) The maximum power dissipation must be derated at elevated temperatures and is dictated by T_{JMAX} , θ_{JA} , and the ambient temperature T_A . The maximum allowable power dissipation is $P_{DMAX} = (T_{JMAX} - T_A)/\theta_{JA}$. For the LM4862, $T_{JMAX} = 150^\circ\text{C}$. The typical junction-to-ambient thermal resistance, when board mounted, is 170°C/W for package number D0008A and is 107°C/W for package number P0008E.
- (4) Human body model, 100 pF discharged through a 1.5 kΩ resistor.
- (5) Machine Model, 200 pF–240 pF discharged through all pins.

Operating Ratings

Temperature Range	$T_{MIN} \leq T_A \leq T_{MAX}$	$-40^\circ\text{C} \leq T_A \leq 85^\circ\text{C}$
Supply Voltage		$2.7V \leq V_{DD} \leq 5.5V$

Electrical Characteristics⁽¹⁾⁽²⁾

The following specifications apply for $V_{DD} = 5V$ unless otherwise specified. Limits apply for $T_A = 25^\circ C$.

Symbol	Parameter	Conditions	LM4862		Units (Limits)
			Typical ⁽³⁾	Limit ⁽⁴⁾	
V_{DD}	Supply Voltage			2.7 5.5	V (min) V (max)
I_{DD}	Quiescent Power Supply Current	$V_{IN} = 0V, I_O = 0A^{(5)}$	3.6	6.0	mA (max)
I_{SD}	Shutdown Current	$V_{PIN1} = V_{DD}$	0.7	5	μA (max)
V_{OS}	Output Offset Voltage	$V_{IN} = 0V$	5	50	mV (max)
P_O	Output Power	THD = 1% (max); $f = 1\text{ kHz}; R_L = 8\Omega$ THD + N = 10%; $f = 1\text{ kHz}; R_L = 8\Omega$	675 825	500	mW (min) mW
THD + N	Total Harmonic Distortion + Noise	$P_O = 500\text{ mWrms}; R_L = 8\Omega$ $A_{VD} = 2; 20\text{ Hz} \leq f \leq 20\text{ kHz}$	0.55		%
PSRR	Power Supply Rejection Ratio	$V_{DD} = 4.9V\text{ to }5.1V$	50		dB

- (1) All voltages are measured with respect to the ground pin, unless otherwise specified.
- (2) Absolute Maximum Ratings indicate limits beyond which damage to the device may occur. Operating Ratings indicate conditions for which the device is functional, but do not ensure specific performance limits. Electrical Characteristics state DC and AC electrical specifications under particular test conditions which ensure specific performance limits. This assumes that the device is within the Operating Ratings. Specifications are not ensured for parameters where no limit is given, however, the typical value is a good indication of device performance.
- (3) Typicals are measured at $25^\circ C$ and represent the parametric norm.
- (4) Limits are ensured to TI's AOQL (Average Outgoing Quality Level).
- (5) The quiescent power supply current depends on the offset voltage when a practical load is connected to the amplifier.

Automatic Switching Circuit

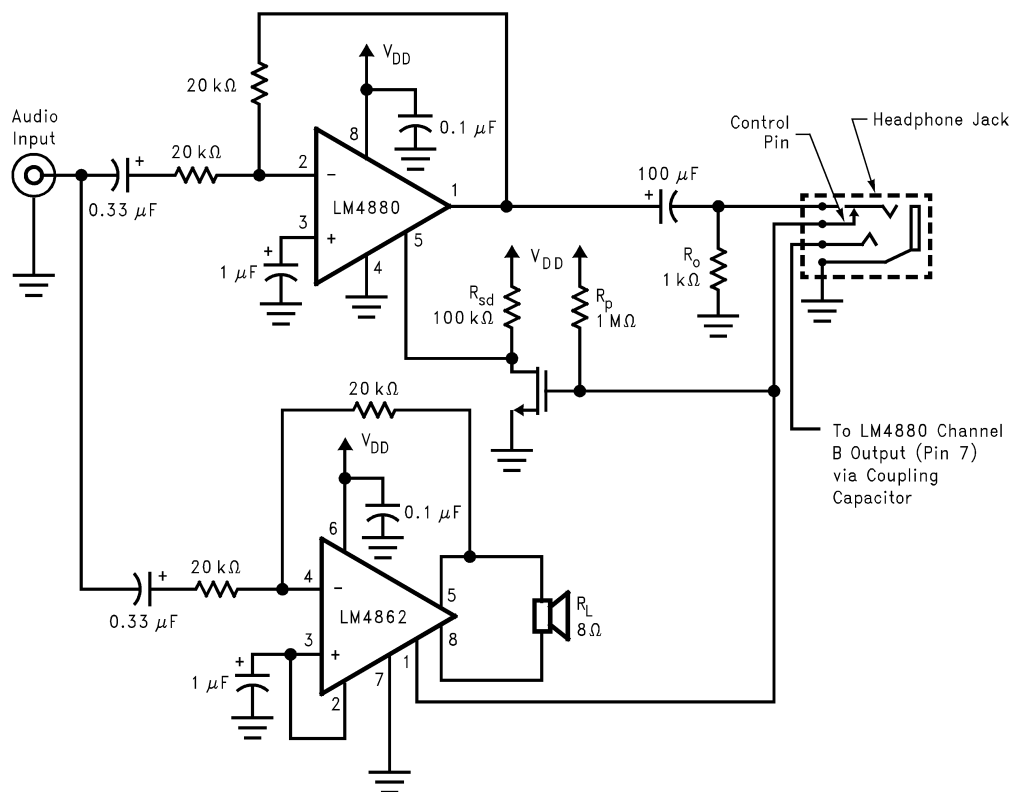

Figure 3. Automatic Switching Circuit

External Components Description

(Figure 1)

Components	Functional Description
1. R_i	Inverting input resistance which sets the closed-loop gain in conjunction with R_f . This resistor also forms a high pass filter with C_i at $f_c = 1/(2\pi R_i C_i)$.
2. C_i	Input coupling capacitor which blocks the DC voltage at the amplifier's input terminals. Also creates a highpass filter with R_i at $f_c = 1/(2\pi R_i C_i)$. Refer to PROPER SELECTION OF EXTERNAL COMPONENTS for an explanation of how to determine the value of C_i .
3. R_f	Feedback resistance which sets the closed-loop gain in conjunction with R_i .
4. C_S	Supply bypass capacitor which provides power supply filtering. Refer to POWER SUPPLY BYPASSING for proper placement and selection of the supply bypass capacitor.
5. C_B	Bypass pin capacitor which provides half-supply filtering. Refer to PROPER SELECTION OF EXTERNAL COMPONENTS for proper placement and selection of the half-supply bypass capacitor.

Typical Performance Characteristics

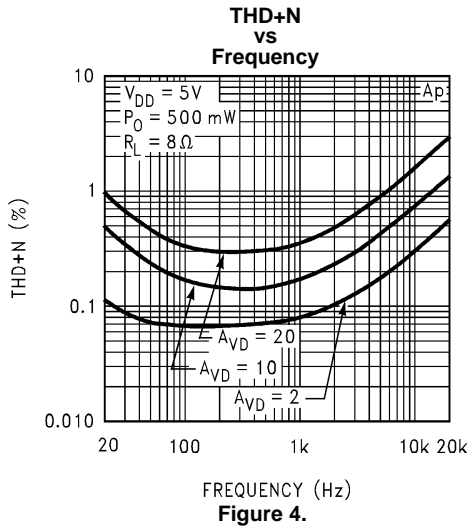

Figure 4.

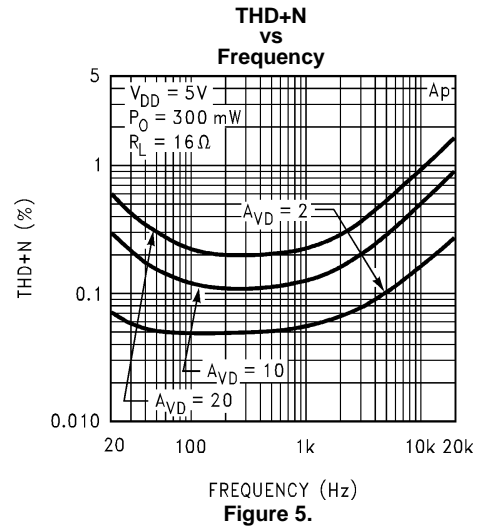

Figure 5.

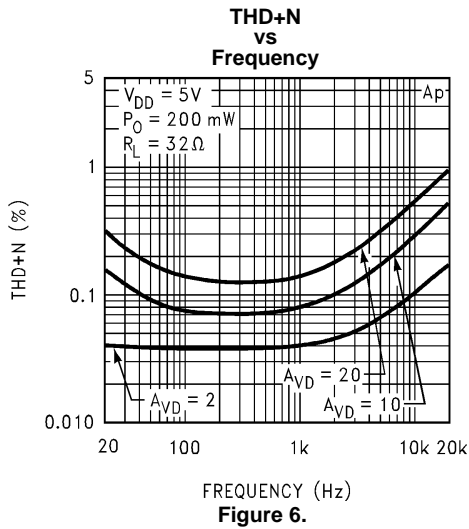

Figure 6.

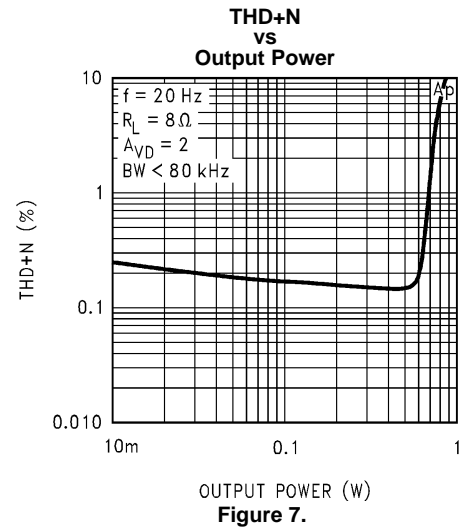

Figure 7.

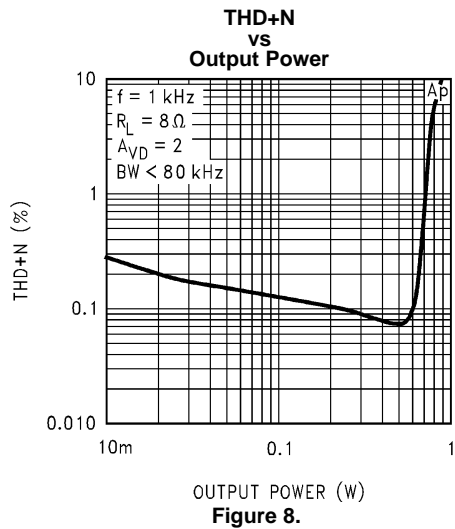

Figure 8.

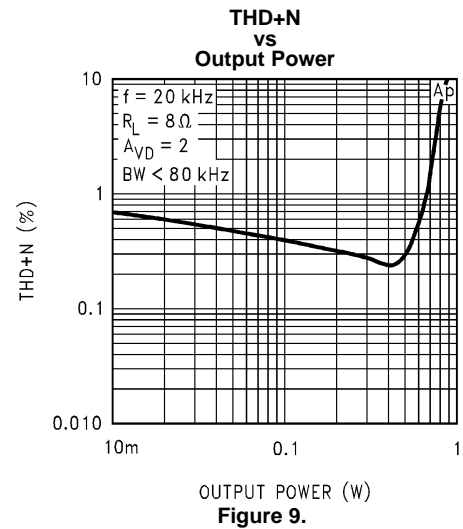

Figure 9.

Typical Performance Characteristics (continued)

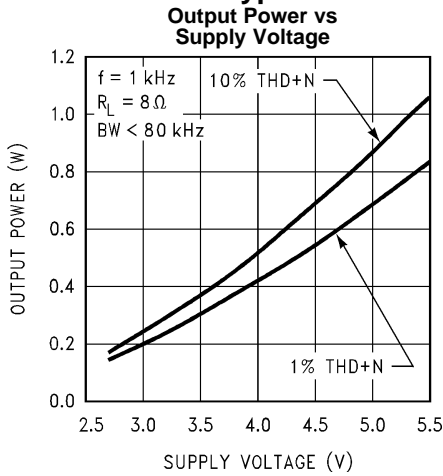

Figure 10.

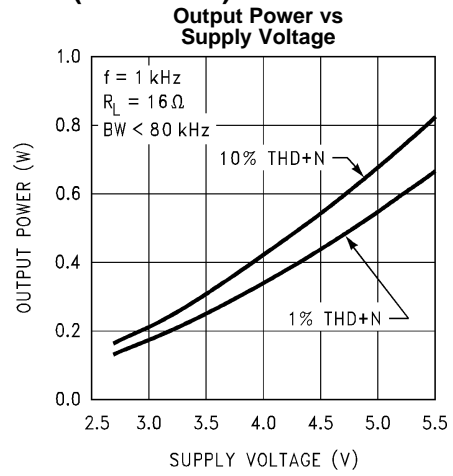

Figure 11.

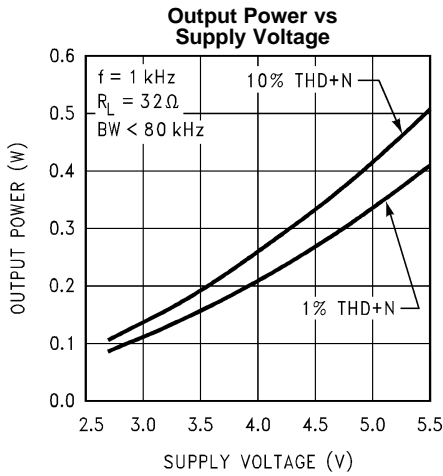

Figure 12.

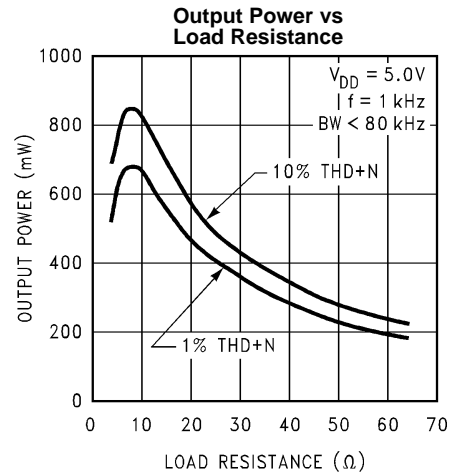

Figure 13.

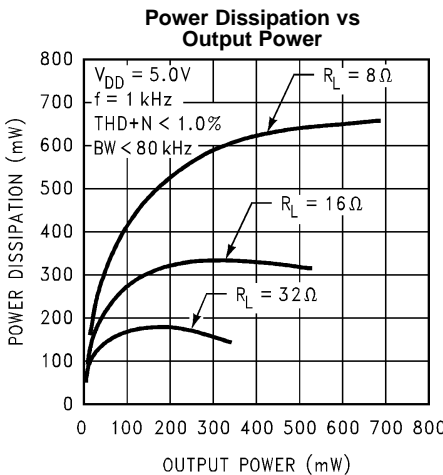

Figure 14.

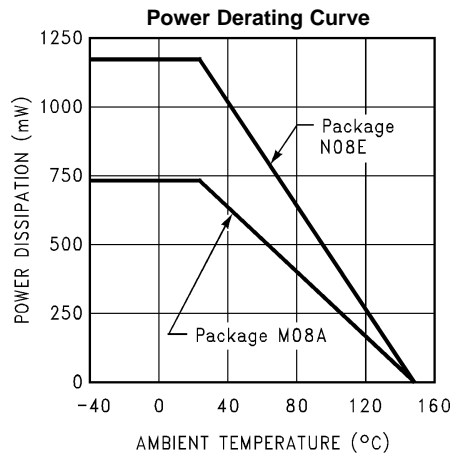

Figure 15.

Typical Performance Characteristics (continued)

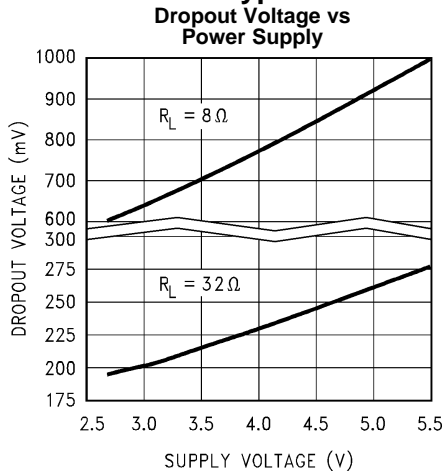

Figure 16.

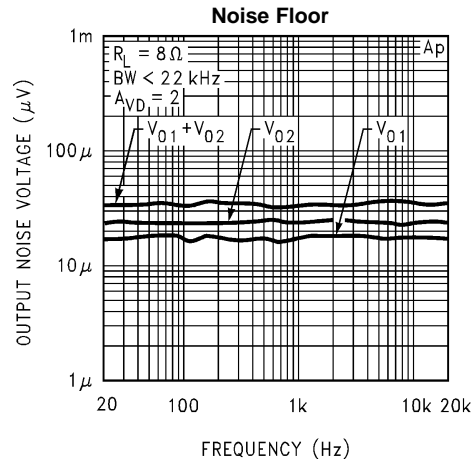

Figure 17.

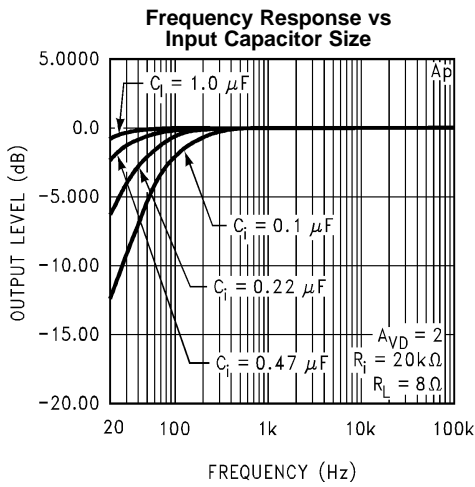

Figure 18.

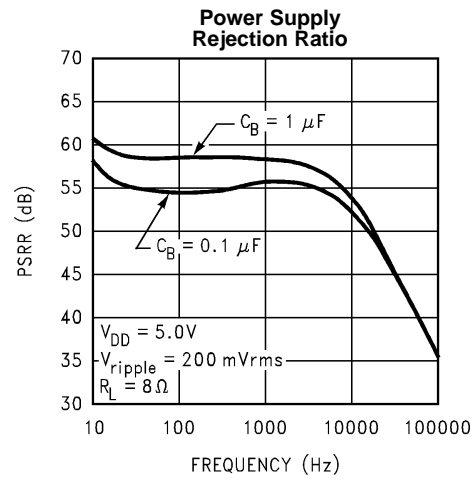

Figure 19.

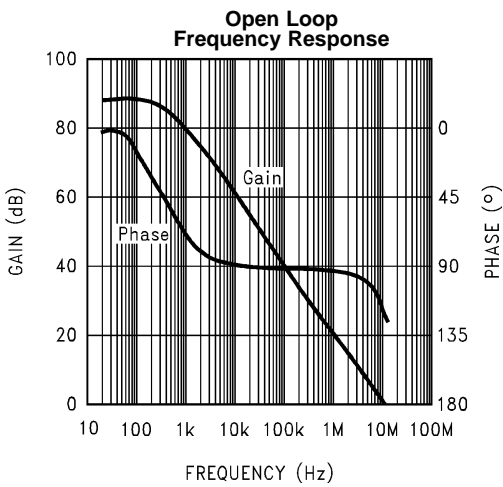

Figure 20.

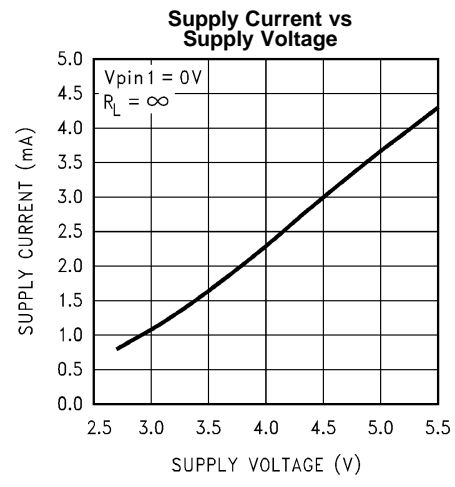

Figure 21.

APPLICATION INFORMATION

BRIDGE CONFIGURATION EXPLANATION

As shown in [Figure 1](#), the LM4862 has two operational amplifiers internally, allowing for a few different amplifier configurations. The first amplifier's gain is externally configurable, while the second amplifier is internally fixed in a unity-gain, inverting configuration. The closed-loop gain of the first amplifier is set by selecting the ratio of R_f to R_i while the second amplifier's gain is fixed by the two internal 10 k Ω resistors. [Figure 1](#) shows that the output of amplifier one serves as the input to amplifier two which results in both amplifiers producing signals identical in magnitude, but out of phase 180°. Consequently, the differential gain for the IC is

$$A_{VD} = 2 \cdot (R_f/R_i) \quad (1)$$

By driving the load differentially through outputs V_{o1} and V_{o2} , an amplifier configuration commonly referred to as “bridged mode” is established. Bridged mode operation is different from the classical single-ended amplifier configuration where one side of the load is connected to ground.

A bridge amplifier design has a few distinct advantages over the single-ended configuration, as it provides differential drive to the load, thus doubling output swing for a specified supply voltage. Consequently, four times the output power is possible as compared to a single-ended amplifier under the same conditions. This increase in attainable output power assumes that the amplifier is not current limited or clipped. In order to choose an amplifier's closed-loop gain without causing excessive clipping which will damage high frequency transducers used in loudspeaker systems, please refer to [AUDIO POWER AMPLIFIER DESIGN](#).

A bridge configuration, such as the one used in LM4862, also creates a second advantage over single-ended amplifiers. Since the differential outputs, V_{o1} and V_{o2} , are biased at half-supply, no net DC voltage exists across the load. This eliminates the need for an output coupling capacitor which is required in a single supply, single-ended amplifier configuration. Without an output coupling capacitor, the half-supply bias across the load would result in both increased internal IC power dissipation and also permanent loudspeaker damage.

POWER DISSIPATION

Power dissipation is a major concern when designing a successful amplifier, whether the amplifier is bridged or single-ended. A direct consequence of the increased power delivered to the load by a bridge amplifier is an increase in internal power dissipation. [Equation 2](#) states the maximum power dissipation point for a bridge amplifier operating at a given supply voltage and driving a specified output load.

$$P_{DMAX} = 4 \cdot (V_{DD})^2 / (2\pi^2 R_L) \quad (2)$$

Since the LM4862 has two operational amplifiers in one package, the maximum internal power dissipation is 4 times that of a single-ended amplifier. Even with this substantial increase in power dissipation, the LM4862 does not require heatsinking. From [Equation 2](#), assuming a 5V power supply and an 8 Ω load, the maximum power dissipation point is 625 mW. The maximum power dissipation point obtained from [Equation 2](#) must not be greater than the power dissipation that results from [Equation 3](#):

$$P_{DMAX} = (T_{JMAX} - T_A) / \theta_{JA} \quad (3)$$

For package D0008A, $\theta_{JA} = 170^\circ\text{C/W}$ and for package P0008E, $\theta_{JA} = 107^\circ\text{C/W}$. $T_{JMAX} = 150^\circ\text{C}$ for the LM4862. Depending on the ambient temperature, T_A , of the system surroundings, [Equation 3](#) can be used to find the maximum internal power dissipation supported by the IC packaging. If the result of [Equation 2](#) is greater than that of [Equation 3](#), then either the supply voltage must be decreased, the load impedance increased, or the ambient temperature reduced. For the typical application of a 5V power supply, with an 8 Ω load, the maximum ambient temperature possible without violating the maximum junction temperature is approximately 44°C provided that device operation is around the maximum power dissipation point. Power dissipation is a function of output power and thus, if typical operation is not around the maximum power dissipation point, the ambient temperature can be increased. Refer to [Typical Performance Characteristics](#) for power dissipation information for lower output powers.

POWER SUPPLY BYPASSING

As with any power amplifier, proper supply bypassing is critical for low noise performance and high power supply rejection. The capacitor location on both the bypass and power supply pins should be as close to the device as possible. As displayed in [Typical Performance Characteristics](#), the effect of a larger half supply bypass capacitor is improved PSSR due to increased half-supply stability. Typical applications employ a 5V regulator with 10 μF and a 0.1 μF bypass capacitors which aid in supply stability, but do not eliminate the need for bypassing the supply nodes of the LM4862. The selection of bypass capacitors, especially C_B , is thus dependant upon desired PSSR requirements, click and pop performance as explained in [PROPER SELECTION OF EXTERNAL COMPONENTS](#), system cost, and size constraints.

SHUTDOWN FUNCTION

In order to reduce power consumption while not in use, the LM4862 contains a shutdown pin to externally turn off the amplifier's bias circuitry. The shutdown feature turns the amplifier off when a logic high is placed on the shutdown pin. The trigger point between a logic low and logic high level is typically half supply. It is best to switch between ground and supply to provide maximum device performance. By switching the shutdown pin to V_{DD} , the LM4862 supply current draw will be minimized in idle mode. While the device will be disabled with shutdown pin voltages less than V_{DD} , the idle current may be greater than the typical value of 0.7 μA . In either case, the shutdown pin should be tied to a definite voltage because leaving the pin floating may result in an unwanted shutdown condition.

In many applications, a microcontroller or microprocessor output is used to control the shutdown circuitry which provides a quick, smooth transition into shutdown. Another solution is to use a single-pole, single-throw switch that when closed, is connected to ground and enables the amplifier. If the switch is open, then a soft pull-up resistor of 47 k Ω will disable the LM4862. There are no soft pull-down resistors inside the LM4862, so a definite shutdown pin voltage must be applied externally, or the internal logic gate will be left floating which could disable the amplifier unexpectedly.

AUTOMATIC SWITCHING CIRCUIT

As shown in [Figure 3](#), the LM4862 and the LM4880 can be set up to automatically switch on and off depending on whether headphones are plugged in. The LM4880 is used to drive a stereo single ended load, while the LM4862 drives a bridged internal speaker.

The [Automatic Switching Circuit](#) is based upon a single control pin common in many headphone jacks which forms a normally closed switch with one of the output pins. The output of this circuit (the voltage on pin 5 of the LM4880) has two states based on the position of the switch. When the switch inside the headphone jack is open, the LM4880 is enabled and the LM4862 is disabled since the NMOS inverter is on. If a headphone jack is not present, it is assumed that the internal speakers should be on and the external speakers should be off. Thus the voltage on the LM4862 shutdown pin is low and the voltage on the LM4880 shutdown pin is high.

The operation of this circuit is rather simple. With the switch closed, R_P and R_O form a resistor divider which produces a gate voltage of less than 50 mV. The gate voltage keeps the NMOS inverter off and R_{SD} pulls the shutdown pin of the LM4880 to the supply voltage. This shuts down the LM4880 and places the LM4862 in its normal mode of operation. When the switch is open, the opposite condition is produced. Resistor R_P pulls the gate of the NMOS high which turns on the inverter and produces a logic low signal on the shutdown pin of the LM4880. This state enables the LM4880 and places the LM4862 in shutdown mode.

Only one channel of this circuit is shown in [Figure 3](#) to keep the drawing simple but a typical application would be a LM4880 driving a stereo headphone jack and two LM4862's driving a pair of internal speakers. If a single internal speaker is required, one LM4862 can be used as a summer to mix the left and right inputs into a mono channel.

PROPER SELECTION OF EXTERNAL COMPONENTS

Proper selection of external components in applications using integrated power amplifiers is critical to optimize device and system performance. While the LM4862 is tolerant of external component combinations, consideration to component values must be used to maximize overall system quality.

The LM4862 is unity-gain stable which gives a designer maximum system flexibility. The LM4862 should be used in low gain configurations to minimize THD+N values, and maximize the signal to noise ratio. Low gain configurations require large input signals to obtain a given output power. Input signals equal to or greater than 1 V_{rms} are available from sources such as audio codecs. Please refer to [AUDIO POWER AMPLIFIER DESIGN](#) for a more complete explanation of proper gain selection.

Besides gain, one of the major considerations is the closed-loop bandwidth of the amplifier. To a large extent, the band-width is dictated by the choice of external components shown in [Figure 1](#). The input coupling capacitor, C_i, forms a first order high pass filter which limits low frequency response. This value should be chosen based on needed frequency response for a few distinct reasons.

Selection of Input Capacitor Size

Large input capacitors are both expensive and space hungry for portable designs. Clearly, a certain sized capacitor is needed to couple in low frequencies without severe attenuation. But in many cases the speakers used in portable systems, whether internal or external, have little ability to reproduce signals below 100–150 Hz. Thus using a large input capacitor may not increase system performance.

In addition to system cost and size, click and pop performance is effected by the size of the input coupling capacitor, C_i. A larger input coupling capacitor requires more charge to reach its quiescent DC voltage (nominally ½ V_{DD}). This charge comes from the output via the feedback and is apt to create pops upon device enable. Thus, by minimizing the capacitor size based on necessary low frequency response, turn-on pops can be minimized.

Besides minimizing the input capacitor size, careful consideration should be paid to the bypass capacitor value. Bypass capacitor, C_B, is the most critical component to minimize turn-on pops since it determines how fast the LM4862 turns on. The slower the LM4862's outputs ramp to their quiescent DC voltage (nominally ½ V_{DD}), the smaller the turn-on pop. Choosing C_B equal to 1.0 μF along with a small value of C_i (in the range of 0.1 μF to 0.39 μF), should produce a virtually clickless and popless shutdown function. While the device will function properly, (no oscillations or motorboating), with C_B equal to 0.1 μF, the device will be much more susceptible to turn-on clicks and pops. Thus, a value of C_B equal to 1.0 μF or larger is recommended in all but the most cost sensitive designs.

AUDIO POWER AMPLIFIER DESIGN

Design a 500 mW/8Ω Audio Amplifier

Given:	
Power Output	500 mW _{rms}
Load Impedance	8Ω
Input Level	1 V _{rms}
Input Impedance	20 kΩ
Bandwidth	100 Hz–20 kHz ± 0.25 dB

A designer must first determine the minimum supply rail to obtain the specified output power. By extrapolating from [Figure 10](#), [Figure 11](#), and [Figure 12](#) in [Typical Performance Characteristics](#), the supply rail can be easily found. A second way to determine the minimum supply rail is to calculate the required V_{opeak} using [Equation 4](#) and add the dropout voltage. Using this method, the minimum supply voltage would be (V_{opeak} + (2*V_{OD})), where V_{OD} is extrapolated from the [Figure 16](#) in [Typical Performance Characteristics](#).

$$V_{opeak} = \sqrt{(2R_L P_O)} \quad (4)$$

Using the Output Power vs Supply Voltage graph for an 8Ω load, the minimum supply rail is 4.3V. But since 5V is a standard supply voltage in most applications, it is chosen for the supply rail. Extra supply voltage creates headroom that allows the LM4862 to reproduce peaks in excess of 500 mW without clipping the signal. At this time, the designer must make sure that the power supply choice along with the output impedance does not violate the conditions explained in [POWER DISSIPATION](#).

Once the power dissipation equations have been addressed, the required differential gain can be determined from [Equation 5](#).

$$A_{VD} \geq \sqrt{(P_O R_L)} / (V_{IN}) = V_{orms} / V_{inrms} \quad (5)$$

$$R_f / R_i = A_{VD} / 2 \quad (6)$$

From [Equation 5](#), the minimum A_{VD} is 2; use $A_{VD} = 2$.

Since the desired input impedance was 20 k Ω , and with a A_{VD} of 2, a ratio of 1:1 of R_f to R_i results in an allocation of $R_i = R_f = 20$ k Ω . The final design step is to address the bandwidth requirements which must be stated as a pair of -3 dB frequency points. Five times away from a -3 dB point is 0.17 dB down from passband response which is better than the required ± 0.25 dB specified. This fact results in a low and high frequency pole of 20 Hz and 100 kHz respectively. As stated in [External Components Description](#), R_i in conjunction with C_i create a highpass filter.



$$C_i \geq 1/(2\pi * 20 \text{ k}\Omega * 20 \text{ Hz}) = 0.397 \mu\text{F}; \text{ use } 0.39 \mu\text{F}. \quad (7)$$

The high frequency pole is determined by the product of the desired high frequency pole, f_H , and the differential gain, A_{VD} . With an $A_{VD} = 2$ and $f_H = 100$ kHz, the resulting GBWP = 100 kHz which is much smaller than the LM4862 GBWP of 12.5 MHz. This figure displays that if a designer has a need to design an amplifier with a higher differential gain, the LM4862 can still be used without running into bandwidth problems.

REVISION HISTORY

Changes from Revision E (May 2013) to Revision F	Page
• Changed layout of National Data Sheet to TI format	11

PACKAGING INFORMATION

Orderable Device	Status (1)	Package Type	Package Drawing	Pins	Package Qty	Eco Plan (2)	Lead finish/ Ball material (6)	MSL Peak Temp (3)	Op Temp (°C)	Device Marking (4/5)	Samples
LM4862M	ACTIVE	SOIC	D	8	95	Non-RoHS & Non-Green	Call TI	Call TI	-40 to 85	LM 4862M	
LM4862M/NOPB	ACTIVE	SOIC	D	8	95	RoHS & Green	SN	Level-1-260C-UNLIM	-40 to 85	LM 4862M	
LM4862MX/NOPB	ACTIVE	SOIC	D	8	2500	RoHS & Green	SN	Level-1-260C-UNLIM	-40 to 85	LM 4862M	

(1) The marketing status values are defined as follows:

ACTIVE: Product device recommended for new designs.

LIFEBUY: TI has announced that the device will be discontinued, and a lifetime-buy period is in effect.

NRND: Not recommended for new designs. Device is in production to support existing customers, but TI does not recommend using this part in a new design.

PREVIEW: Device has been announced but is not in production. Samples may or may not be available.

OBSELETE: TI has discontinued the production of the device.

(2) **RoHS:** TI defines "RoHS" to mean semiconductor products that are compliant with the current EU RoHS requirements for all 10 RoHS substances, including the requirement that RoHS substance do not exceed 0.1% by weight in homogeneous materials. Where designed to be soldered at high temperatures, "RoHS" products are suitable for use in specified lead-free processes. TI may reference these types of products as "Pb-Free".

RoHS Exempt: TI defines "RoHS Exempt" to mean products that contain lead but are compliant with EU RoHS pursuant to a specific EU RoHS exemption.

Green: TI defines "Green" to mean the content of Chlorine (Cl) and Bromine (Br) based flame retardants meet JS709B low halogen requirements of <=1000ppm threshold. Antimony trioxide based flame retardants must also meet the <=1000ppm threshold requirement.

(3) MSL, Peak Temp. - The Moisture Sensitivity Level rating according to the JEDEC industry standard classifications, and peak solder temperature.

(4) There may be additional marking, which relates to the logo, the lot trace code information, or the environmental category on the device.

(5) Multiple Device Markings will be inside parentheses. Only one Device Marking contained in parentheses and separated by a "~" will appear on a device. If a line is indented then it is a continuation of the previous line and the two combined represent the entire Device Marking for that device.

(6) Lead finish/Ball material - Orderable Devices may have multiple material finish options. Finish options are separated by a vertical ruled line. Lead finish/Ball material values may wrap to two lines if the finish value exceeds the maximum column width.

Important Information and Disclaimer:The information provided on this page represents TI's knowledge and belief as of the date that it is provided. TI bases its knowledge and belief on information provided by third parties, and makes no representation or warranty as to the accuracy of such information. Efforts are underway to better integrate information from third parties. TI has taken and continues to take reasonable steps to provide representative and accurate information but may not have conducted destructive testing or chemical analysis on incoming materials and chemicals. TI and TI suppliers consider certain information to be proprietary, and thus CAS numbers and other limited information may not be available for release.

In no event shall TI's liability arising out of such information exceed the total purchase price of the TI part(s) at issue in this document sold by TI to Customer on an annual basis.

TAPE AND REEL INFORMATION



QUADRANT ASSIGNMENTS FOR PIN 1 ORIENTATION IN TAPE



*All dimensions are nominal

Device	Package Type	Package Drawing	Pins	SPQ	Reel Diameter (mm)	Reel Width W1 (mm)	A0 (mm)	B0 (mm)	K0 (mm)	P1 (mm)	W (mm)	Pin1 Quadrant
LM4862MX/NOPB	SOIC	D	8	2500	330.0	12.4	6.5	5.4	2.0	8.0	12.0	Q1

TAPE AND REEL BOX DIMENSIONS



*All dimensions are nominal

Device	Package Type	Package Drawing	Pins	SPQ	Length (mm)	Width (mm)	Height (mm)
LM4862MX/NOPB	SOIC	D	8	2500	367.0	367.0	35.0



D0008A

PACKAGE OUTLINE

SOIC - 1.75 mm max height

SMALL OUTLINE INTEGRATED CIRCUIT



4214825/C 02/2019

NOTES:

1. Linear dimensions are in inches [millimeters]. Dimensions in parenthesis are for reference only. Controlling dimensions are in inches. Dimensioning and tolerancing per ASME Y14.5M.
2. This drawing is subject to change without notice.
3. This dimension does not include mold flash, protrusions, or gate burrs. Mold flash, protrusions, or gate burrs shall not exceed $.006$ [0.15] per side.
4. This dimension does not include interlead flash.
5. Reference JEDEC registration MS-012, variation AA.

EXAMPLE BOARD LAYOUT

D0008A

SOIC - 1.75 mm max height

SMALL OUTLINE INTEGRATED CIRCUIT



LAND PATTERN EXAMPLE
EXPOSED METAL SHOWN
SCALE:8X



SOLDER MASK DETAILS

4214825/C 02/2019

NOTES: (continued)

- 6. Publication IPC-7351 may have alternate designs.
- 7. Solder mask tolerances between and around signal pads can vary based on board fabrication site.

EXAMPLE STENCIL DESIGN

D0008A

SOIC - 1.75 mm max height

SMALL OUTLINE INTEGRATED CIRCUIT



SOLDER PASTE EXAMPLE
BASED ON .005 INCH [0.125 MM] THICK STENCIL
SCALE:8X

4214825/C 02/2019

NOTES: (continued)

8. Laser cutting apertures with trapezoidal walls and rounded corners may offer better paste release. IPC-7525 may have alternate design recommendations.
9. Board assembly site may have different recommendations for stencil design.

IMPORTANT NOTICE AND DISCLAIMER

TI PROVIDES TECHNICAL AND RELIABILITY DATA (INCLUDING DATASHEETS), DESIGN RESOURCES (INCLUDING REFERENCE DESIGNS), APPLICATION OR OTHER DESIGN ADVICE, WEB TOOLS, SAFETY INFORMATION, AND OTHER RESOURCES "AS IS" AND WITH ALL FAULTS, AND DISCLAIMS ALL WARRANTIES, EXPRESS AND IMPLIED, INCLUDING WITHOUT LIMITATION ANY IMPLIED WARRANTIES OF MERCHANTABILITY, FITNESS FOR A PARTICULAR PURPOSE OR NON-INFRINGEMENT OF THIRD PARTY INTELLECTUAL PROPERTY RIGHTS.

These resources are intended for skilled developers designing with TI products. You are solely responsible for (1) selecting the appropriate TI products for your application, (2) designing, validating and testing your application, and (3) ensuring your application meets applicable standards, and any other safety, security, or other requirements. These resources are subject to change without notice. TI grants you permission to use these resources only for development of an application that uses the TI products described in the resource. Other reproduction and display of these resources is prohibited. No license is granted to any other TI intellectual property right or to any third party intellectual property right. TI disclaims responsibility for, and you will fully indemnify TI and its representatives against, any claims, damages, costs, losses, and liabilities arising out of your use of these resources.

TI's products are provided subject to TI's Terms of Sale (www.ti.com/legal/termsofsale.html) or other applicable terms available either on ti.com or provided in conjunction with such TI products. TI's provision of these resources does not expand or otherwise alter TI's applicable warranties or warranty disclaimers for TI products.

Mailing Address: Texas Instruments, Post Office Box 655303, Dallas, Texas 75265
Copyright © 2020, Texas Instruments Incorporated