

LM48310 Boomer® Audio Power Amplifier Series Ultra-Low EMI, Filterless, 2.6W, Mono, Class D Audio Power Amplifier with E²S

Check for Samples: [LM48310](#)

FEATURES

- Passes FCC Class B Radiated Emissions with 20 inches of cable
- E²S System Reduces EMI while Preserving Audio Quality and Efficiency
- Output Short Circuit Protection with Auto-Recovery
- Stereo Class D Operation
- No Output Filter Required
- Internally Configured Gain (12dB)
- Synchronizable Oscillator for Multi-Channel Operation
- Low Power Shutdown Mode
- Minimum External Components
- "Click and Pop" Suppression
- Micro-Power Shutdown
- Available in Space-Saving WSON Package

APPLICATIONS

- Mobile Phones
- PDAs
- Laptops

KEY SPECIFICATIONS

- Efficiency at 3.6V, 400mW into 8Ω 85% (typ)
- Efficiency at 5V, 1W into 8Ω 88% (typ)
- Quiescent Power Supply Current at 5V 3.2mA
- Power Output at V_{DD} = 5V, R_L = 4Ω, THD+N ≤ 10% 2.6W (typ)
- Power Output at V_{DD} = 5V, R_L = 8Ω, THD+N ≤ 10% 1.6W (typ)
- Shutdown current 0.01μA (typ)

DESCRIPTION

The LM48310 is a single supply, high efficiency, mono, 2.6W, filterless switching audio amplifier. The LM48310 features TI's Enhanced Emissions Suppression (E²S) system, that features a unique patent-pending ultra low EMI, spread spectrum, PWM architecture, that significantly reduces RF emissions while preserving audio quality and efficiency. The E²S system improves battery life, reduces external component count, board area consumption, system cost, and simplifying design.

The LM48310 is designed to meet the demands of portable multimedia devices. Operating from a single 5V supply, the device is capable of delivering 2.6W of continuous output power to a 4Ω load with less than 10% THD+N. Flexible power supply requirements allow operation from 2.4V to 5.5V. The LM48310 offers two logic selectable modulation schemes, fixed frequency mode, and an EMI suppressing spread spectrum mode. The E²S system includes an advanced, patent-pending edge rate control (ERC) architecture that further reduce emissions by minimizing the high frequency component of the device output, while maintaining high quality audio reproduction (THD+N = 0.03%) and high efficiency (η = 88%). The LM48310 also features a SYNC_IN input and SYNC_OUT, which allows multiple devices to operate with the same switching frequency, eliminating beat frequencies and any other interference caused by clock intermodulation.

The LM48310 features high efficiency compared to conventional Class AB amplifiers, and other low EMI Class D amplifiers. When driving an 8Ω speaker from a 5V supply, the device operates with 88% efficiency at P_O = 1W. The gain of the LM48310 is internally set to 12dB, further reducing external component count. A low power shutdown mode reduces supply current consumption to 0.01μA.

Advanced output short circuit protection with auto-recovery prevents the device from being damaged during fault conditions. Superior click and pop suppression eliminates audible transients on power-up/down and during shutdown.



Please be aware that an important notice concerning availability, standard warranty, and use in critical applications of Texas Instruments semiconductor products and disclaimers thereto appears at the end of this data sheet.

All trademarks are the property of their respective owners.

EMI Graph 20in of Speaker Cable

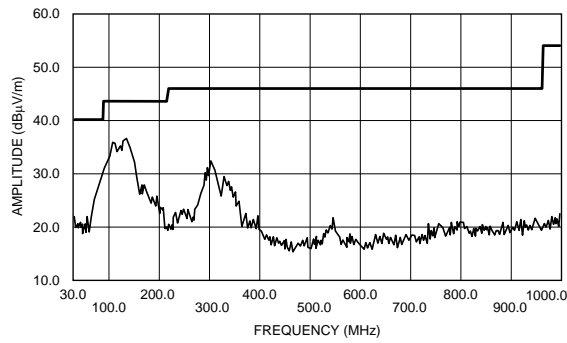

Typical Application

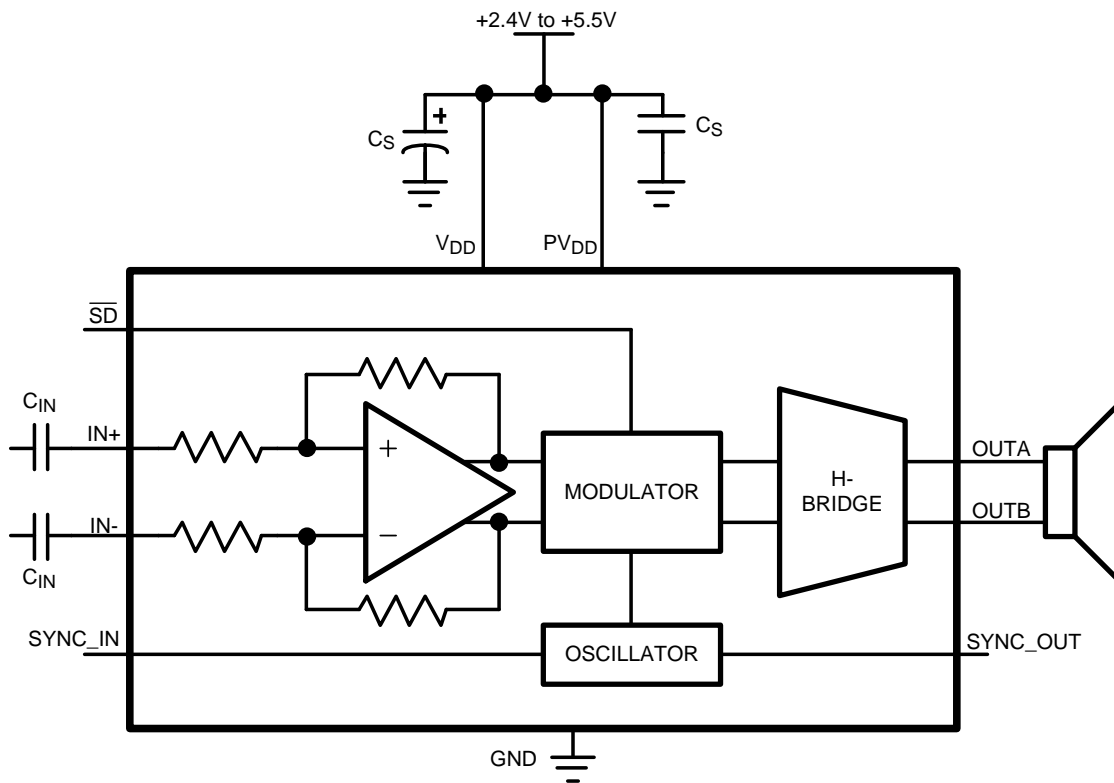

Figure 1. Typical Audio Amplifier Application Circuit

Connection Diagram

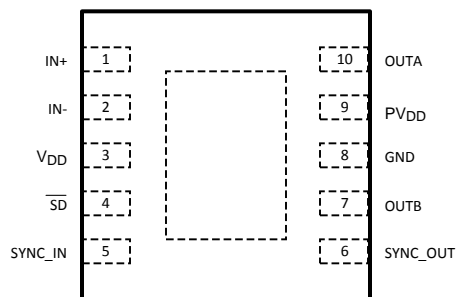

Figure 2. WSON Package - Top View
See Package Number DSC0010

PIN DESCRIPTIONS

Pin	Name	Description
1	IN+	Non-Inverting Input
2	IN-	Inverting Input
3	V _{DD}	Power Supply
4	$\overline{\text{SD}}$	Active Low Shutdown Input. Connect to V _{DD} for normal operation.
5	SYNC_IN	Mode Select and External Oscillator Input. SYNC_IN = V _{DD} : Spread spectrum mode with $f_s = 300\text{kHz} \pm 30\%$ SYNC_IN = GND: Fixed frequency mode with $f_s = 300\text{kHz}$ SYNC_IN = Clocked: $f_s = \text{external clock frequency}$
6	SYNC_OUT	Clock Output
7	OUTB	Inverting Output
8	GND	Ground
9	PV _{DD}	H-Bridge Power Supply
10	OUTA	Non-Inverting Output



These devices have limited built-in ESD protection. The leads should be shorted together or the device placed in conductive foam during storage or handling to prevent electrostatic damage to the MOS gates.

ABSOLUTE MAXIMUM RATINGS⁽¹⁾⁽²⁾⁽³⁾

Supply Voltage		6.0V
Storage Temperature		-65°C to +150°C
Input Voltage		- 0.3V to V _{DD} +0.3V
Power Dissipation ⁽⁴⁾		Internally Limited
ESD Rating ⁽⁵⁾		2000V
ESD Rating ⁽⁶⁾		200V
Junction Temperature		150°C
Thermal Resistance	θ_{JC}	8.2°C/W
	θ_{JA}	49.2°C/W

- (1) “*Absolute Maximum Ratings*” indicate limits beyond which damage to the device may occur, including inoperability and degradation of device reliability and/or performance. Functional operation of the device and/or non-degradation at the *Absolute Maximum Ratings* or other conditions beyond those indicated in the *Recommended Operating Conditions* is not implied. The *Recommended Operating Conditions* indicate conditions at which the device is functional and the device should not be operated beyond such conditions. All voltages are measured with respect to the ground pin, unless otherwise specified.
- (2) The *Electrical Characteristics* tables list ensured specifications under the listed *Recommended Operating Conditions* except as otherwise modified or specified by the *Electrical Characteristics Conditions* and/or Notes. Typical specifications are estimations only and are not ensured.
- (3) If Military/Aerospace specified devices are required, please contact the TI Sales Office/ Distributors for availability and specifications.
- (4) The maximum power dissipation must be derated at elevated temperatures and is dictated by T_{JMAX}, θ_{JA} , and the ambient temperature, T_A. The maximum allowable power dissipation is P_{DMAX} = (T_{JMAX} - T_A) / θ_{JA} or the number given in *Absolute Maximum Ratings*, whichever is lower.
- (5) Human body model, applicable std. JESD22-A114C.
- (6) Machine model, applicable std. JESD22-A115-A.

OPERATING RATINGS⁽¹⁾⁽²⁾

Temperature Range T _{MIN} ≤ T _A ≤ T _{MAX}	-40°C ≤ T _A ≤ +85°C
Supply Voltage	2.4V ≤ V _{DD} ≤ 5.5V

- (1) “*Absolute Maximum Ratings*” indicate limits beyond which damage to the device may occur, including inoperability and degradation of device reliability and/or performance. Functional operation of the device and/or non-degradation at the *Absolute Maximum Ratings* or other conditions beyond those indicated in the *Recommended Operating Conditions* is not implied. The *Recommended Operating Conditions* indicate conditions at which the device is functional and the device should not be operated beyond such conditions. All voltages are measured with respect to the ground pin, unless otherwise specified.
- (2) The *Electrical Characteristics* tables list ensured specifications under the listed *Recommended Operating Conditions* except as otherwise modified or specified by the *Electrical Characteristics Conditions* and/or Notes. Typical specifications are estimations only and are not ensured.

ELECTRICAL CHARACTERISTICS V_{DD} = PV_{DD} = 5V⁽¹⁾⁽²⁾

The following specifications apply for A_V = 12dB, (R_L = 8Ω, SYNC_IN = V_{DD} (Spread Spectrum mode), f = 1kHz, unless otherwise specified. Limits apply for T_A = 25°C.

Symbol	Parameter	Conditions	LM48310		Units (Limits)
			Typical ⁽³⁾	Limit ⁽⁴⁾⁽²⁾	
V _{OS}	Differential Output Offset Voltage	V _{IN} = 0	1	3	mV (max)
I _{DD}	Quiescent Power Supply Current	V _{IN} = 0, R _L = ∞ V _{DD} = 3.6V	2.7	3.9	mA (max)
		V _{IN} = 0, R _L = ∞ V _{DD} = 5V	3.2	4.4	mA (max)
I _{DD}	Quiescent Power Supply Current	V _{IN} = 0, V _{DD} = 3.6V	2.7		mA
		V _{IN} = 0, V _{DD} = 5V	3.2		mA
I _{SD}	Shutdown Current	V _{SD} = GND	0.01	1.0	μA
V _{IH}	Logic Input High Voltage	\overline{SD} input, V _{DD} = 3.6V		1.4	V (min)

- (1) The *Electrical Characteristics* tables list ensured specifications under the listed *Recommended Operating Conditions* except as otherwise modified or specified by the *Electrical Characteristics Conditions* and/or Notes. Typical specifications are estimations only and are not ensured.
- (2) R_L is a resistive load in series with two inductors to simulate an actual speaker load. For R_L = 8Ω, the load is 15μH + 8Ω, +15μH. For R_L = 4Ω, the load is 15μH + 4Ω + 15μH.
- (3) Typical values represent most likely parametric norms at T_A = +25°C, and at the *Recommended Operation Conditions* at the time of product characterization and are not specified.
- (4) Datasheet min/max specification limits are specified by test or statistical analysis.

ELECTRICAL CHARACTERISTICS $V_{DD} = PV_{DD} = 5V^{(1)(2)}$ (continued)

The following specifications apply for $A_V = 12\text{dB}$, ($R_L = 8\Omega$, $\text{SYNC_IN} = V_{DD}$ (Spread Spectrum mode), $f = 1\text{kHz}$, unless otherwise specified. Limits apply for $T_A = 25^\circ\text{C}$.

Symbol	Parameter	Conditions	LM48310		Units (Limits)
			Typical ⁽³⁾	Limit ⁽⁴⁾⁽²⁾	
V_{IL}	Logic Input Low Voltage	$\overline{\text{SD}}$ input, $V_{DD} = 3.6\text{V}$		0.4	V (max)
T_{WU}	Wake Up Time		7.5		ms
f_{SW}	Switching Frequency	$\text{SYNC_IN} = V_{DD}$ (Spread Spectrum)	300±30		kHz
		$\text{SYNC_IN} = \text{GND}$ (Fixed Frequency)	300		kHz
		$\text{SYNC_IN} = \text{External Clock}$ Minimum Frequency	200		kHz
		$\text{SYNC_IN} = \text{External Clock}$ Maximum Frequency	1000		kHz
A_V	Gain		12	11 13	dB (min) dB (max)
R_{IN}	Input Resistance		20	17	k Ω (min)
P_O	Output Power	$R_L = 4\Omega$, THD = 10% $f = 1\text{kHz}$, 22kHz BW $V_{DD} = 5\text{V}$ $V_{DD} = 3.6\text{V}$ $V_{DD} = 2.5\text{V}$	2.6 1.3 555		W W mW
		$R_L = 8\Omega$, THD = 10% (max) $f = 1\text{kHz}$, 22kHz BW $V_{DD} = 5\text{V}$ $V_{DD} = 3.6\text{V}$ $V_{DD} = 2.5\text{V}$	1.6 800 354		W mW mW
		$R_L = 4\Omega$, THD = 1% (max) $f = 1\text{kHz}$, 22kHz BW $V_{DD} = 5\text{V}$ $V_{DD} = 3.6\text{V}$ $V_{DD} = 2.5\text{V}$	2.1 1 446		W W mW
		$R_L = 8\Omega$, THD = 1% (max) $f = 1\text{kHz}$, 22kHz BW $V_{DD} = 5\text{V}$ $V_{DD} = 3.6\text{V}$ $V_{DD} = 2.5\text{V}$	1.3 640 286	1.1	W (min) mW mW
THD+N	Total Harmonic Distortion + Noise	$P_O = 200\text{mW}$, $R_L = 8\Omega$, $f = 1\text{kHz}$	0.03		% (max)
		$P_O = 100\text{mW}$, $R_L = 8\Omega$, $f = 1\text{kHz}$	0.03		%
PSRR	Power Supply Rejection Ratio (Input Referred)	$V_{RIPPLE} = 200\text{mV}_{P-P}$ Sine, $f_{RIPPLE} = 217\text{Hz}$, Inputs AC GND, $C_{IN} = 1\mu\text{F}$, Input referred	82		dB
		$V_{RIPPLE} = 200\text{mV}_{P-P}$ Sine, $f_{RIPPLE} = 1\text{kHz}$, Inputs AC GND, $C_{IN} = 1\mu\text{F}$, Input referred	80		dB
CMRR	Common Mode Rejection Ratio	$V_{RIPPLE} = 1\text{V}_{P-P}$ $f_{RIPPLE} = 217\text{Hz}$	70		dB
η	Efficiency	$V_{DD} = 5\text{V}$, $P_{OUT} = 1\text{W}$ $R_L = 8\Omega$, $f = 1\text{kHz}$	88		%
		$V_{DD} = 3.6\text{V}$, $P_{OUT} = 400\text{mW}$ $R_L = 8\Omega$, $f = 1\text{kHz}$	85		%
SNR	Signal to Noise Ratio	$V_{DD} = 5\text{V}$, $P_O = 1\text{W}$, Fixed Frequency Mode	97		dB
		$V_{DD} = 5\text{V}$, $P_O = 1\text{W}$, Spread Spectrum Mode	97		dB
ϵ_{OS}	Output Noise	Input referred, Fixed Frequency Mode, A-weighted Filter	14		μV
		Input referred, Spread Spectrum Mode, Unweighted	28		μV

TYPICAL PERFORMANCE CHARACTERISTICS

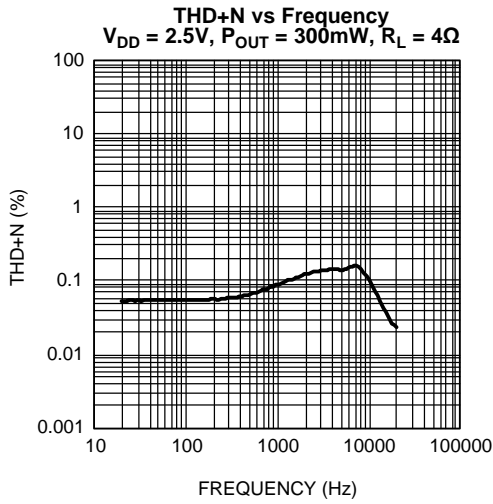

Figure 3.

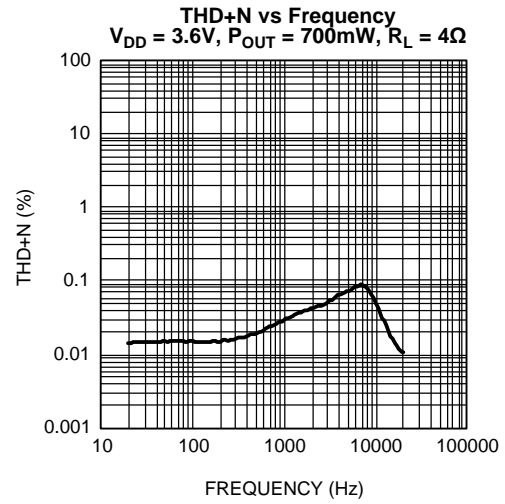

Figure 4.

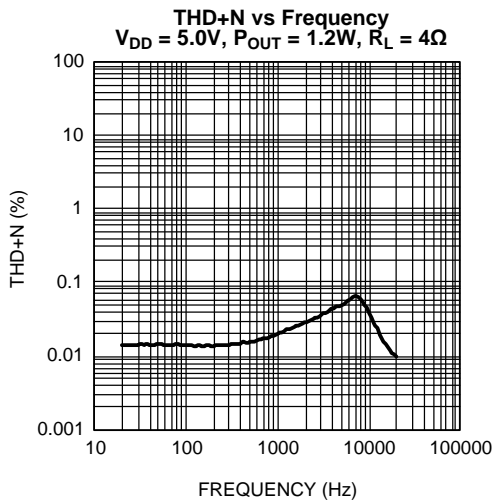

Figure 5.

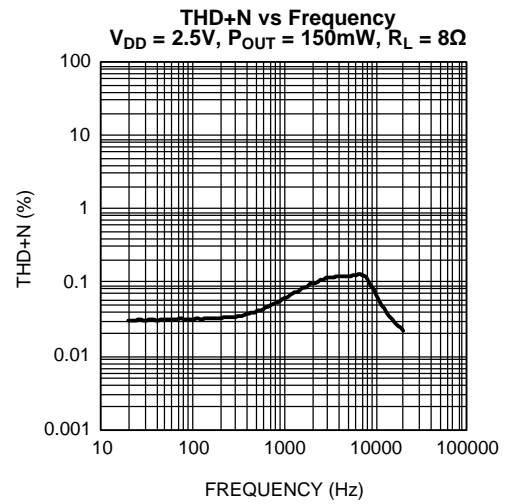

Figure 6.

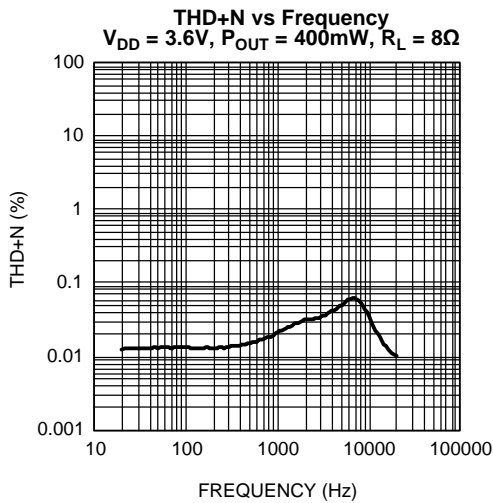

Figure 7.

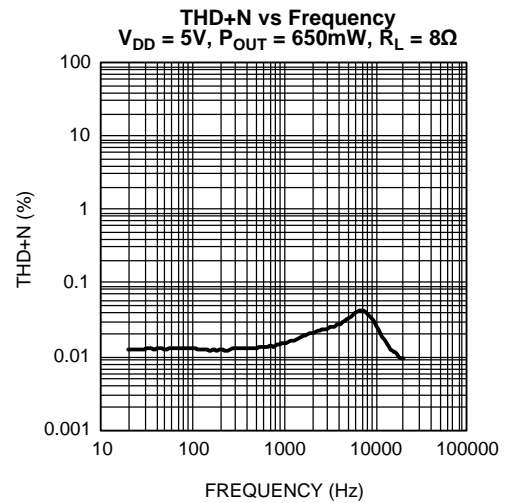

Figure 8.

TYPICAL PERFORMANCE CHARACTERISTICS (continued)

THD+N vs Output Power
f = 1kHz, R_L = 4Ω

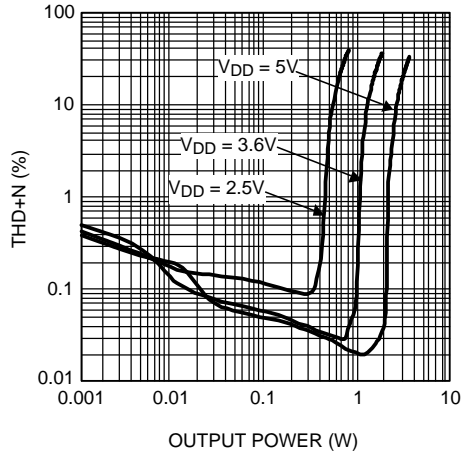

Figure 9.

THD+N vs Output Power
f = 1kHz, R_L = 8Ω

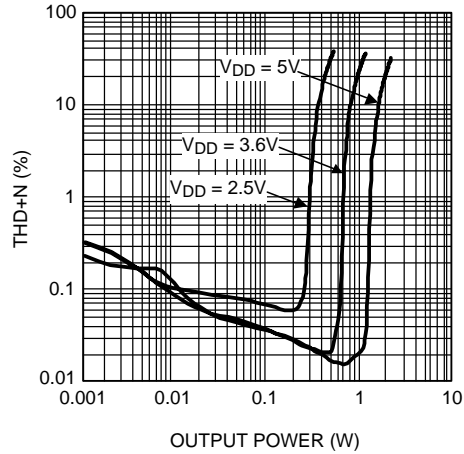

Figure 10.

Efficiency vs Output Power
f = 1kHz, R_L = 4Ω

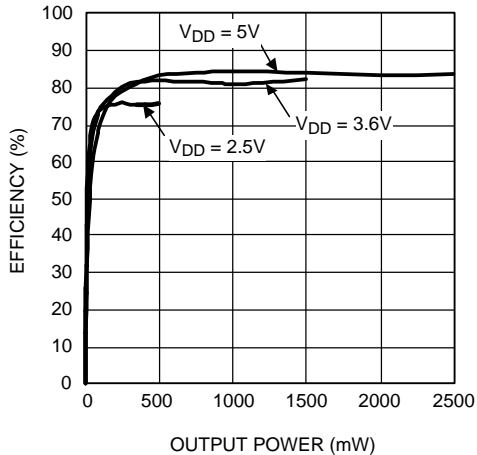

Figure 11.

Efficiency vs Output Power
f = 1kHz, R_L = 8Ω

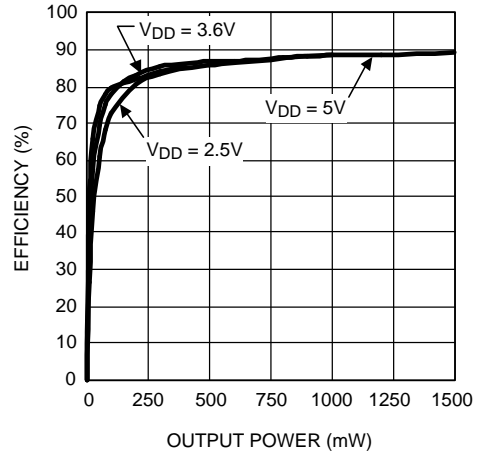

Figure 12.

Power Dissipation vs Output Power
f = 1kHz, R_L = 4Ω

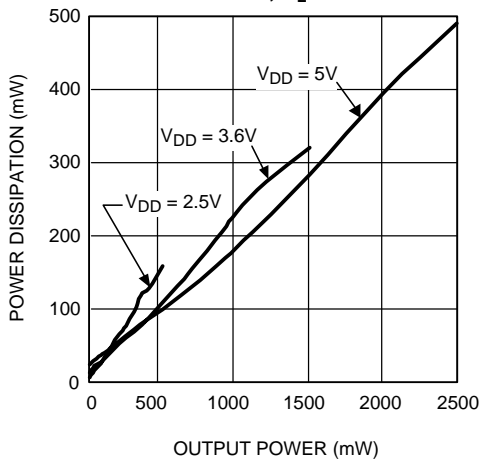

Figure 13.

Power Dissipation vs Output Power
f = 1kHz, R_L = 8Ω

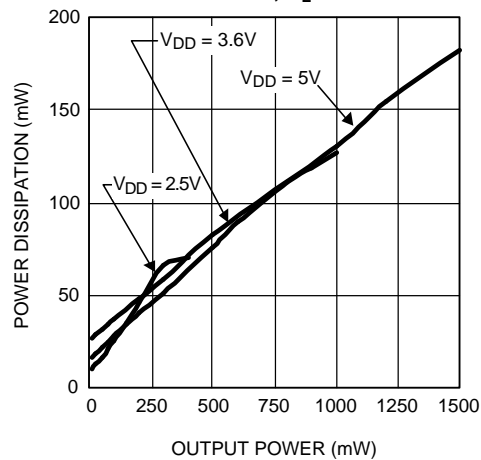

Figure 14.

TYPICAL PERFORMANCE CHARACTERISTICS (continued)

Output Power vs Supply Voltage
 $f = 1\text{kHz}, R_L = 4\Omega$

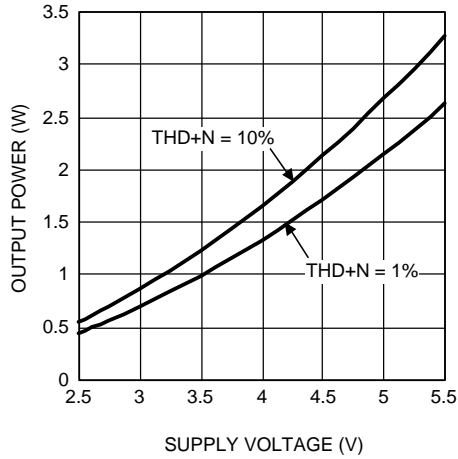

Figure 15.

Output Power vs Supply Voltage
 $f = 1\text{kHz}, R_L = 8\Omega$

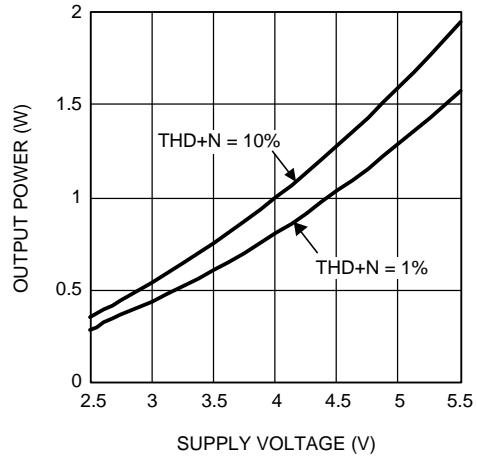

Figure 16.

PSRR vs Frequency
 $V_{DD} = 3.6\text{V}, V_{RIPPLE} = 200\text{mV}_{P-P}, R_L = 8\Omega$

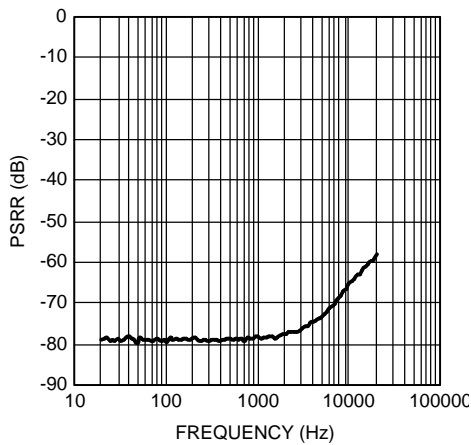

Figure 17.

PSRR vs Frequency
 $V_{DD} = 5.0\text{V}, V_{RIPPLE} = 200\text{mV}_{P-P}, R_L = 8\Omega$

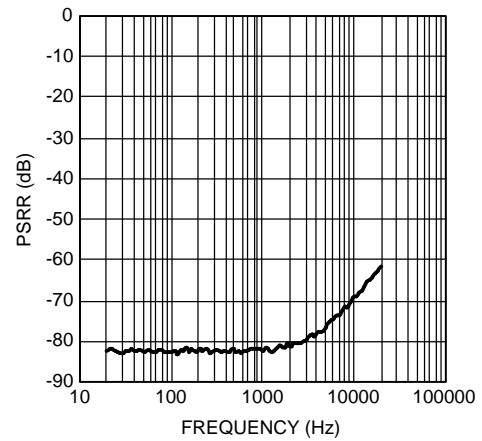

Figure 18.

CMRR vs Frequency
 $V_{DD} = 3.6\text{V}, V_{RIPPLE} = 1\text{V}_{P-P}, R_L = 8\Omega$

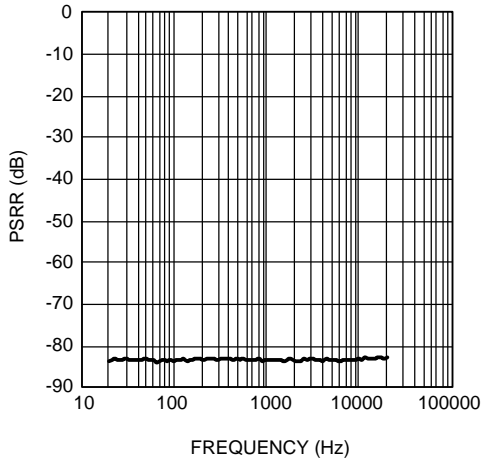

Figure 19.

CMRR vs Frequency
 $V_{DD} = 5.0\text{V}, V_{RIPPLE} = 1\text{V}_{P-P}, R_L = 8\Omega$

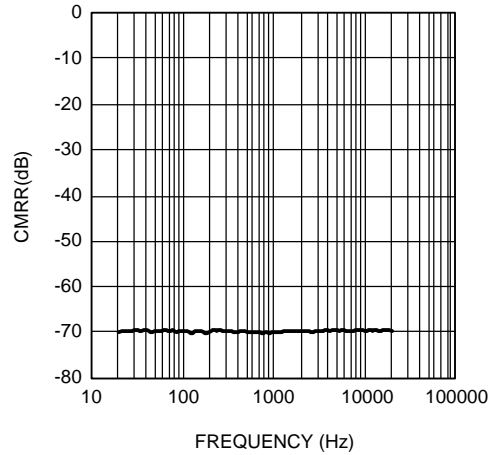

Figure 20.

TYPICAL PERFORMANCE CHARACTERISTICS (continued)

Fixed Frequency Output Spectrum vs Frequency
 $V_{DD} = 5.0V, V_{IN} = 1V_{RMS}, R_L = 8\Omega$

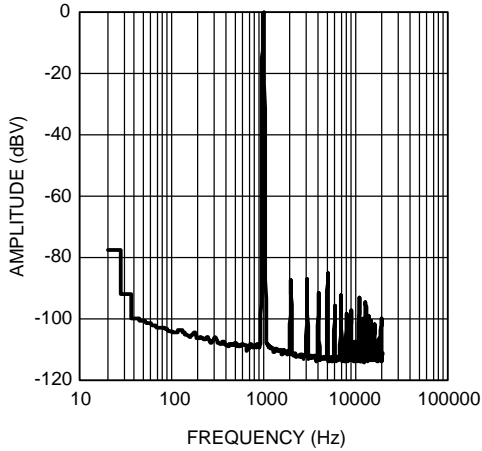

Figure 21.

Spread Spectrum Output Spectrum vs Frequency
 $V_{DD} = 5.0V, V_{IN} = 1V_{RMS}, R_L = 8\Omega$

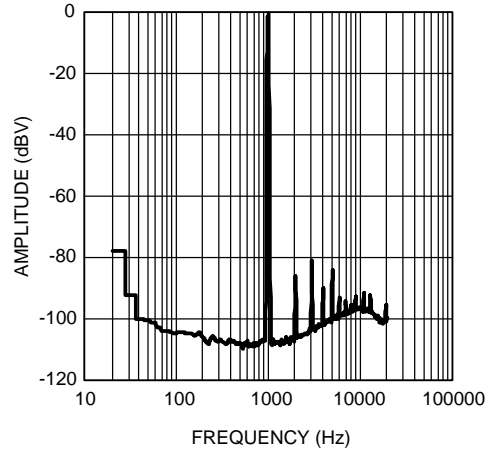

Figure 22.

Wideband Fixed Frequency Output Spectrum vs Frequency
 $V_{DD} = 5.0V, R_L = 8\Omega$

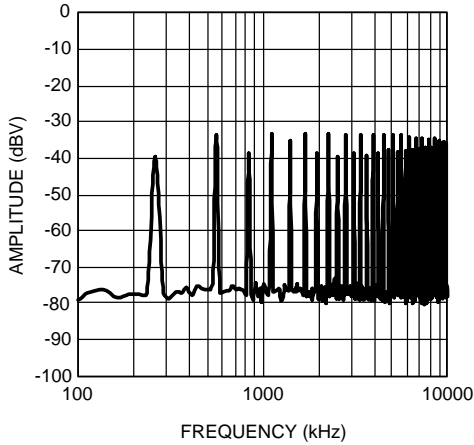

Figure 23.

Wideband Spread Spectrum Output Spectrum vs Frequency
 $V_{DD} = 5.0V, R_L = 8\Omega$

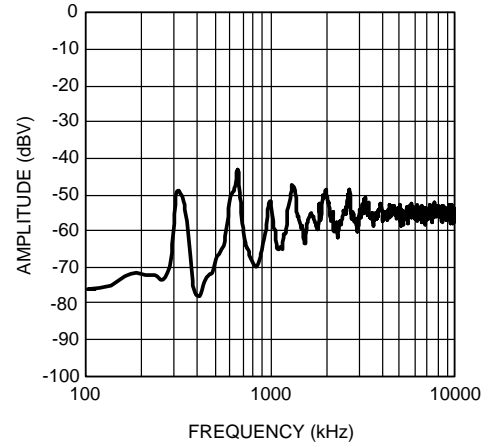

Figure 24.

Supply Current vs Supply Voltage No Load

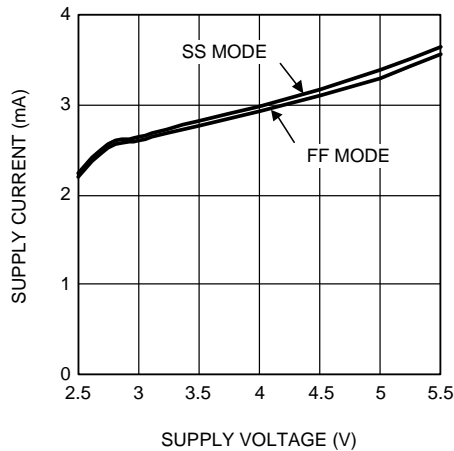

Figure 25.

Shutdown Supply Current vs Supply Voltage No Load

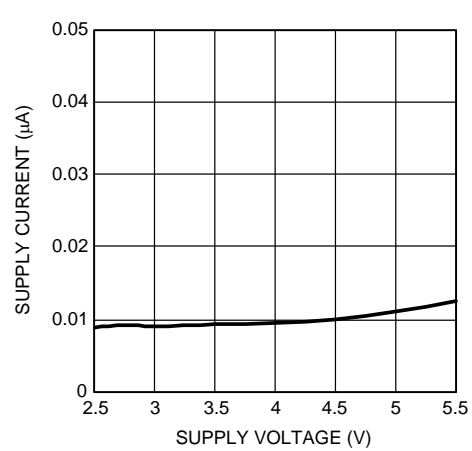

Figure 26.

APPLICATION INFORMATION

GENERAL AMPLIFIER FUNCTION

The LM48310 mono Class D audio power amplifier features a filterless modulation scheme that reduces external component count, conserving board space and reducing system cost. With no signal applied, the outputs (V_{OUTA} and V_{OUTB}) switch between V_{DD} and GND with a 50% duty cycle, in phase, causing the two outputs to cancel. This cancellation results in no net voltage across the speaker, thus there is no current to the load in the idle state.

With the input signal applied, the duty cycle (pulse width) of the LM48310 outputs changes. For increasing output voltage, the duty cycle of V_{OUTA} increases, while the duty cycle of V_{OUTB} decreases. For decreasing output voltages, the converse occurs. The difference between the two pulse widths yields the differential output voltage.

ENHANCED EMISSIONS SUPPRESSION SYSTEM (E²S)

The LM48310 features 's patent-pending E²S system that reduces EMI, while maintaining high quality audio reproduction and efficiency. The E²S system features a synchronizable oscillator with selectable spread spectrum, and advanced edge rate control (ERC). The LM48310 ERC greatly reduces the high frequency components of the output square waves by controlling the output rise and fall times, slowing the transitions to reduce RF emissions, while maximizing THD+N and efficiency performance. The overall result of the E²S system is a filterless Class D amplifier that passes FCC Class B radiated emissions standards with 20in of twisted pair cable, with excellent 0.03% THD+N and high 88% efficiency.

FIXED FREQUENCY MODE (SYNC_IN = GND)

The LM48310 features two modulations schemes, a fixed frequency mode and a spread spectrum mode. Select the fixed frequency mode by setting SYNC_IN = GND. In fixed frequency mode, the amplifier output switch at a constant 300kHz. In fixed frequency mode, the output spectrum consists of the fundamental and its associated harmonics (see [TYPICAL PERFORMANCE CHARACTERISTICS](#)).

SPREAD SPECTRUM MODE (SYNC_IN = V_{DD})

The logic selectable spread spectrum mode eliminates the need for output filters, ferrite beads or chokes. In spread spectrum mode, the switching frequency varies randomly by 30% about a 300kHz center frequency, reducing the wideband spectral contend, improving EMI emissions radiated by the speaker and associated cables and traces. Where a fixed frequency class D exhibits large amounts of spectral energy at multiples of the switching frequency, the spread spectrum architecture of the LM48310 spreads that energy over a larger bandwidth (See [TYPICAL PERFORMANCE CHARACTERISTICS](#)). The cycle-to-cycle variation of the switching period does not affect the audio reproduction, efficiency, or PSRR. Set SYNC_IN = V_{DD} for spread spectrum mode.

EXTERNAL CLOCK MODE (SYNC_IN = CLOCK)

Connecting a clock signal to SYNC_IN synchronizes the LM48310 oscillator to an external clock, moving the output spectral components out of a sensitive frequency band, and minimizing audible beat frequencies when multiple LM48310s are used in a single system. The LM48310 accepts an external clock frequency between 200kHz and 1MHz. The LM48310 can be synchronized to a spread spectrum clock, allowing multiple LM48310s to be synchronized in spread spectrum mode (see [TYPICAL PERFORMANCE CHARACTERISTICS](#)).

SYNC_OUT

SYNC_OUT is a clock output for synchronizing external devices. The SYNC_OUT signal is identical in frequency and duty cycle of the amplifier's switching frequency. When the LM48310 is in fixed frequency mode, SYNC_OUT is a fixed, 300kHz clock. When the LM48310 is in spread spectrum mode, SYNC_OUT is an identical spread spectrum clock. When the LM48310 is driven by an external clock, SYNC_OUT is identical to the external clock. If unused, leave SYNC_OUT floating.

Multiple LM48310s can be synchronized to a single clock. In [Figure 27](#), device U1 is the master, providing a spread spectrum clock to the slave device (U2). This configuration synchronizes the switching frequencies of the two devices, eliminating any audible beat frequencies. Because SYNC_OUT has no audio content, there is minimal THD+N degradation or crosstalk between the devices, [Figure 28](#) - [Figure 30](#).

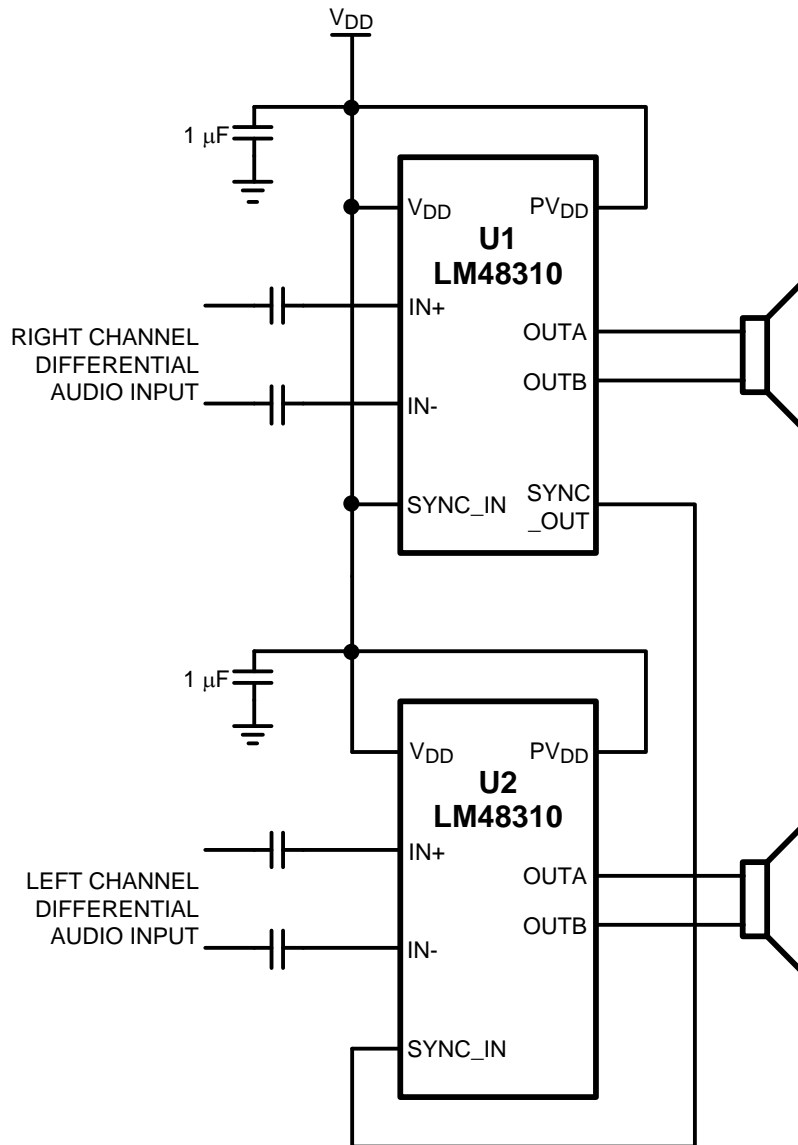

Figure 27. Cascaded LM48310

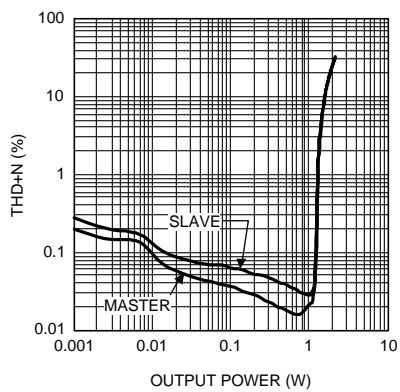

Figure 28. THD+N vs Output Power

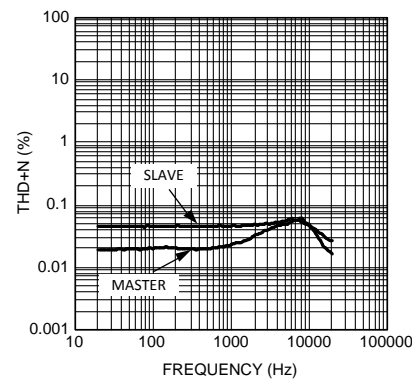

Figure 29. THD+N vs Frequency

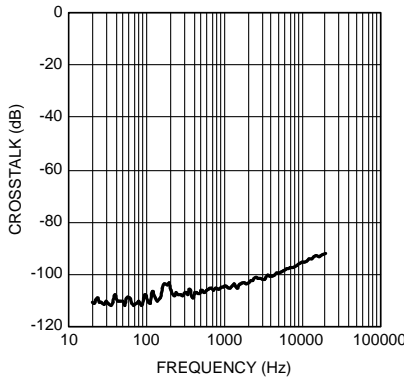

Figure 30. Crosstalk vs Frequency

DIFFERENTIAL AMPLIFIER EXPLANATION

As logic supplies continue to shrink, system designers are increasingly turning to differential analog signal handling to preserve signal to noise ratios with restricted voltage signs. The LM48310 features a fully differential speaker amplifier. A differential amplifier amplifies the difference between the two input signals. Traditional audio power amplifiers have typically offered only single-ended inputs resulting in a 6dB reduction of SNR relative to differential inputs. The LM48310 also offers the possibility of DC input coupling which eliminates the input coupling capacitors. A major benefit of the fully differential amplifier is the improved common mode rejection ratio (CMRR) over single ended input amplifiers. The increased CMRR of the differential amplifier reduces sensitivity to ground offset related noise injection, especially important in noisy systems.

POWER DISSIPATION AND EFFICIENCY

The major benefit of a Class D amplifier is increased efficiency versus a Class AB. The efficiency of the LM48310 is attributed to the region of operation of the transistors in the output stage. The Class D output stage acts as current steering switches, consuming negligible amounts of power compared to their Class AB counterparts. Most of the power loss associated with the output stage is due to the IR loss of the MOSFET on-resistance, along with switching losses due to gate charge.

SHUTDOWN FUNCTION

The LM48310 features a low current shutdown mode. Set $\overline{SD} = GND$ to disable the amplifier and reduce supply current to 0.01 μ A.

Switch \overline{SD} between GND and V_{DD} for minimum current consumption is shutdown. The LM48310 may be disabled with shutdown voltages in between GND and V_{DD} , the idle current will be greater than the typical 0.1 μ A value.

The LM48310 shutdown input has an internal pulldown resistor. The purpose of this resistor is to eliminate any unwanted state changes when \overline{SD} is floating. To minimize shutdown current, \overline{SD} should be driven to GND or left floating. If \overline{SD} is not driven to GND or floating, an increase in shutdown supply current will be noticed.

AUDIO AMPLIFIER POWER SUPPLY BYPASSING/FILTERING

Proper power supply bypassing is critical for low noise performance and high PSRR. Place the supply bypass capacitors as close to the device as possible. Typical applications employ a voltage regulator with 10 μ F and 0.1 μ F bypass capacitors that increase supply stability. These capacitors do not eliminate the need for bypassing of the LM48310 supply pins. A 1 μ F capacitor is recommended.

AUDIO AMPLIFIER INPUT CAPACITOR SELECTION

Input capacitors may be required for some applications, or when the audio source is single-ended. Input capacitors block the DC component of the audio signal, eliminating any conflict between the DC component of the audio source and the bias voltage of the LM48310. The input capacitors create a high-pass filter with the input resistors R_{IN} . The -3dB point of the high pass filter is found using Equation 1 below.

$$f = 1 / 2\pi R_{IN} C_{IN}$$

Where

- R_{IN} is the value of the input resistor given in the [Electrical Characteristics](#) table (1)

The input capacitors can also be used to remove low frequency content from the audio signal. Small speakers cannot reproduce, and may even be damaged by low frequencies. High pass filtering the audio signal helps protect the speakers. When the LM48310 is using a single-ended source, power supply noise on the ground is seen as an input signal. Setting the high-pass filter point above the power supply noise frequencies, 217Hz in a GSM phone, for example, filters out the noise such that it is not amplified and heard on the output. Capacitors with a tolerance of 10% or better are recommended for impedance matching and improved CMRR and PSRR.

AUDIO AMPLIFIER GAIN

The gain of the LM48310 is internally set to 12dB. The gain can be reduced by adding additional input resistance [Figure 31](#). In this configuration, the gain of the device is given by:

$$A_V = 2 \times [R_F / (R_{INEXT} + R_{IN})]$$

Where

- R_F is 40k Ω
- R_{IN} is 20k Ω
- R_{INEXT} is the value of the additional external resistor (2)

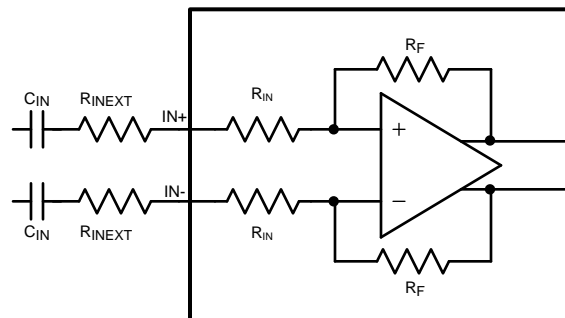

Figure 31. Reduced Gain Configuration

SINGLE-ENDED AUDIO AMPLIFIER CONFIGURATION

The LM48310 is compatible with single-ended sources. When configured for single-ended inputs, input capacitors must be used to block and DC component at the input of the device. [Figure 32](#) shows the typical single-ended applications circuit.

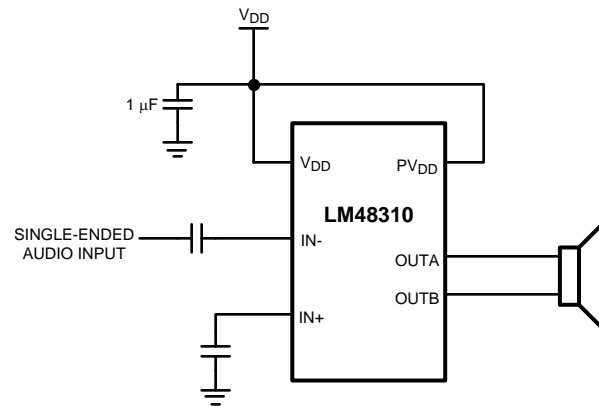

Figure 32. Single-Ended Input Configuration

PCB LAYOUT GUIDELINES

As output power increases, interconnect resistance (PCB traces and wires) between the amplifier, load and power supply create a voltage drop. The voltage loss due to the traces between the LM48310 and the load results in lower output power and decreased efficiency. Higher trace resistance between the supply and the LM48310 has the same effect as a poorly regulated supply, increasing ripple on the supply line, and reducing peak output power. The effects of residual trace resistance increases as output current increases due to higher output power, decreased load impedance or both. To maintain the highest output voltage swing and corresponding peak output power, the PCB traces that connect the output pins to the load and the supply pins to the power supply should be as wide as possible to minimize trace resistance.

The use of power and ground planes will give the best THD+N performance. In addition to reducing trace resistance, the use of power planes creates parasitic capacitors that help to filter the power supply line.

The inductive nature of the transducer load can also result in overshoot on one of both edges, clamped by the parasitic diodes to GND and V_{DD} in each case. From an EMI standpoint, this is an aggressive waveform that can radiate or conduct to other components in the system and cause interference. It is essential to keep the power and output traces short and well shielded if possible. Use of ground planes beads and micro-strip layout techniques are all useful in preventing unwanted interference.

As the distance from the LM48310 and the speaker increases, the amount of EMI radiation increases due to the output wires or traces acting as antennas become more efficient with length. Ferrite chip inductors placed close to the LM48310 outputs may be needed to reduce EMI radiation.

Designator	Quantity	Description
C1	1	10 μ F \pm 10% 16V 500 Ω Tantalum Capacitor (B Case) AVX TPSB106K016R0500
C2, C3	2	1 μ F \pm 10% 16V X7R Ceramic Capacitor (603) Panasonic ECJ-1VB1C105K
C4, C5	2	1 μ F \pm 10% 16V X7R Ceramic Capacitor (1206) Panasonic ECJ-3YB1C105K
C6	1	Not Installed Ceramic Capacitor (603)
R1	1	0 Ω \pm 1% resistor (603)
JP1 — JP2	2	3 Pin Headers
LM48310SDL	1	LM48310SD (10-pin WSON)

LM48310 Demo Board Schematic

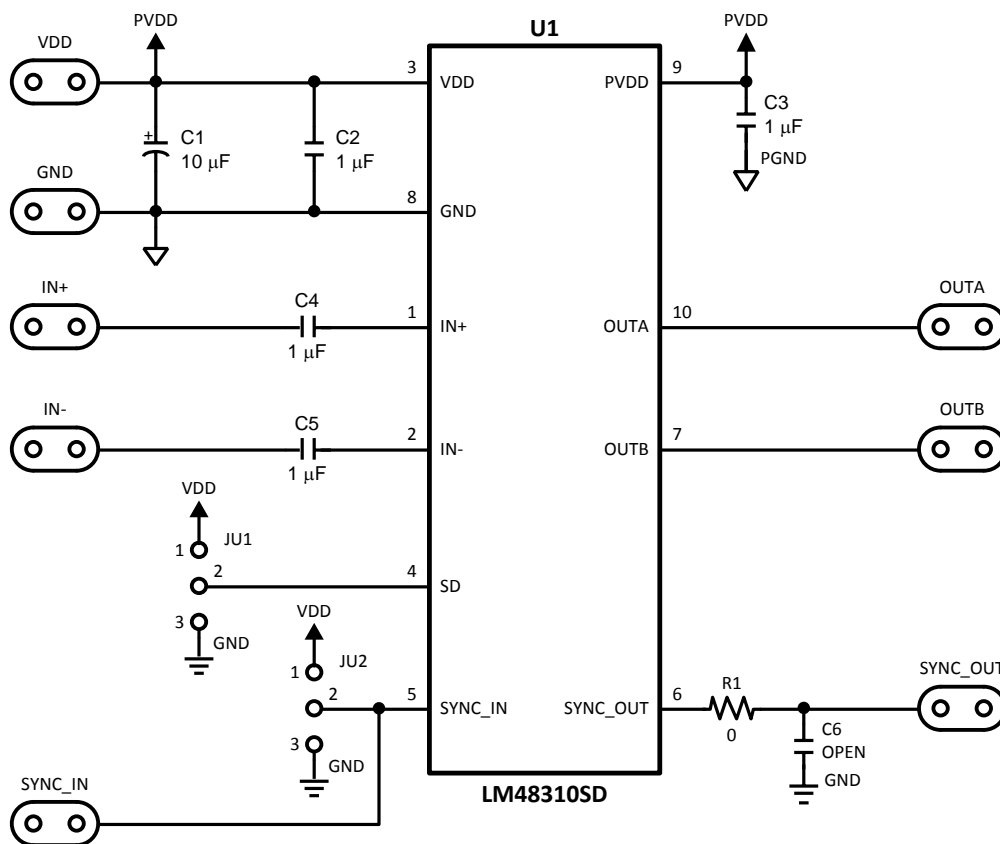

Figure 33. LM48310 DEMO BOARD SCHEMATIC

Demo Boards

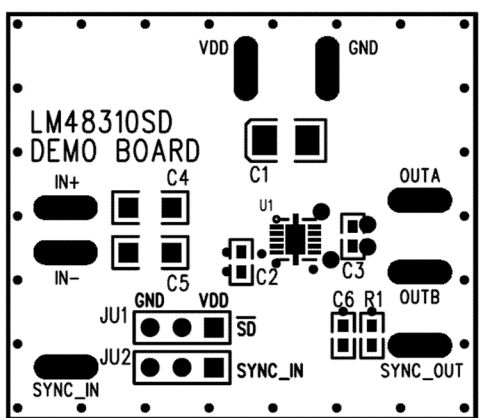

Figure 34. Top Silkscreen

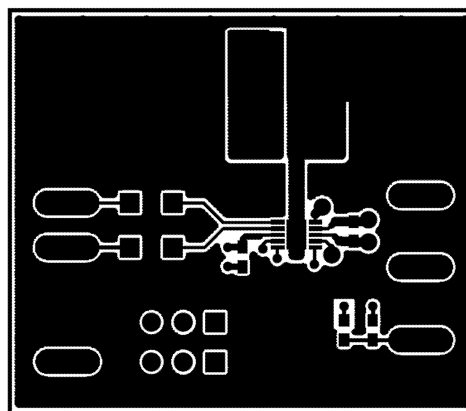

Figure 35. Top Layer

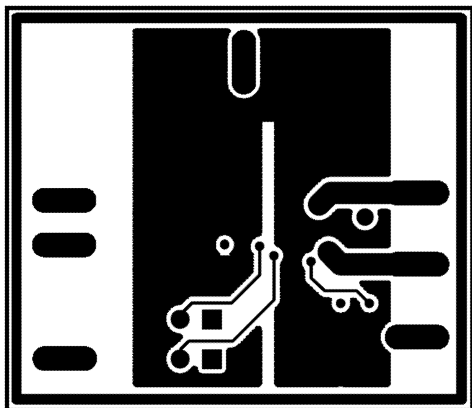

Figure 36. Layer 2 (GND)

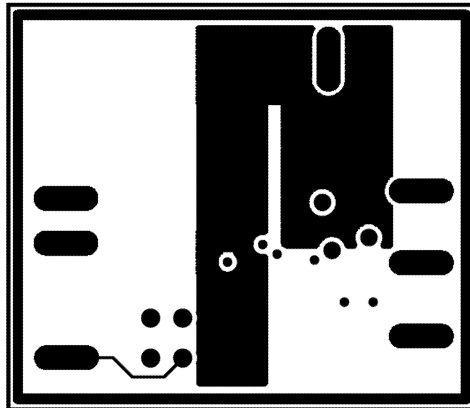

Figure 37. Layer 3 (V_{DD})

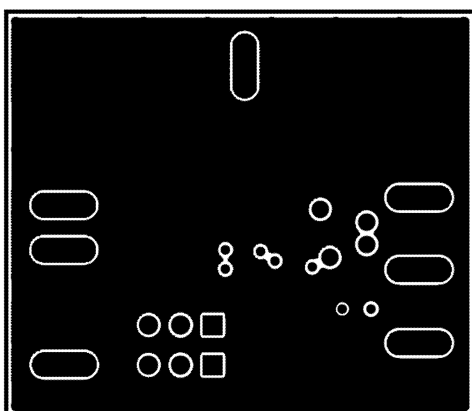

Figure 38. Bottom Layer

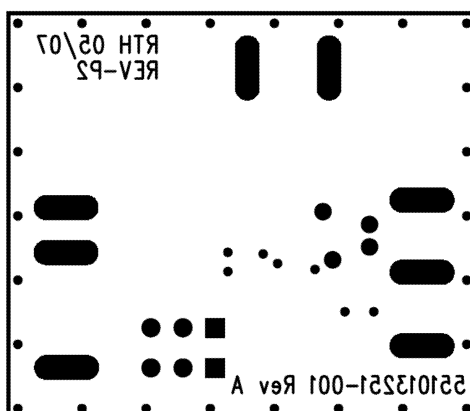

Figure 39. Bottom Silkscreen

REVISION HISTORY

Rev	Date	Description
1.0	11/13/07	Initial release.
1.01	02/26/08	Fixed few typos (Pin Description table).
1.02	03/04/08	Text edits under SHUTDOWN FUNCTION (Application Information section).
1.03	06/24/09	Text edits.

Changes from Revision C (May 2013) to Revision D
Page

-
- Changed layout of National Data Sheet to TI format [16](#)
-

PACKAGING INFORMATION

Orderable Device	Status (1)	Package Type	Package Drawing	Pins	Package Qty	Eco Plan (2)	Lead/Ball Finish (6)	MSL Peak Temp (3)	Op Temp (°C)	Device Marking (4/5)	Samples
LM48310SD/NOPB	ACTIVE	WSON	DSC	10	1000	Green (RoHS & no Sb/Br)	SN	Level-1-260C-UNLIM	-40 to 85	GI8	Samples

(1) The marketing status values are defined as follows:

ACTIVE: Product device recommended for new designs.

LIFEBUY: TI has announced that the device will be discontinued, and a lifetime-buy period is in effect.

NRND: Not recommended for new designs. Device is in production to support existing customers, but TI does not recommend using this part in a new design.

PREVIEW: Device has been announced but is not in production. Samples may or may not be available.

OBSOLETE: TI has discontinued the production of the device.

(2) **RoHS:** TI defines "RoHS" to mean semiconductor products that are compliant with the current EU RoHS requirements for all 10 RoHS substances, including the requirement that RoHS substance do not exceed 0.1% by weight in homogeneous materials. Where designed to be soldered at high temperatures, "RoHS" products are suitable for use in specified lead-free processes. TI may reference these types of products as "Pb-Free".

RoHS Exempt: TI defines "RoHS Exempt" to mean products that contain lead but are compliant with EU RoHS pursuant to a specific EU RoHS exemption.

Green: TI defines "Green" to mean the content of Chlorine (Cl) and Bromine (Br) based flame retardants meet JS709B low halogen requirements of <=1000ppm threshold. Antimony trioxide based flame retardants must also meet the <=1000ppm threshold requirement.

(3) MSL, Peak Temp. - The Moisture Sensitivity Level rating according to the JEDEC industry standard classifications, and peak solder temperature.

(4) There may be additional marking, which relates to the logo, the lot trace code information, or the environmental category on the device.

(5) Multiple Device Markings will be inside parentheses. Only one Device Marking contained in parentheses and separated by a "~" will appear on a device. If a line is indented then it is a continuation of the previous line and the two combined represent the entire Device Marking for that device.

(6) Lead/Ball Finish - Orderable Devices may have multiple material finish options. Finish options are separated by a vertical ruled line. Lead/Ball Finish values may wrap to two lines if the finish value exceeds the maximum column width.

Important Information and Disclaimer:The information provided on this page represents TI's knowledge and belief as of the date that it is provided. TI bases its knowledge and belief on information provided by third parties, and makes no representation or warranty as to the accuracy of such information. Efforts are underway to better integrate information from third parties. TI has taken and continues to take reasonable steps to provide representative and accurate information but may not have conducted destructive testing or chemical analysis on incoming materials and chemicals. TI and TI suppliers consider certain information to be proprietary, and thus CAS numbers and other limited information may not be available for release.

In no event shall TI's liability arising out of such information exceed the total purchase price of the TI part(s) at issue in this document sold by TI to Customer on an annual basis.

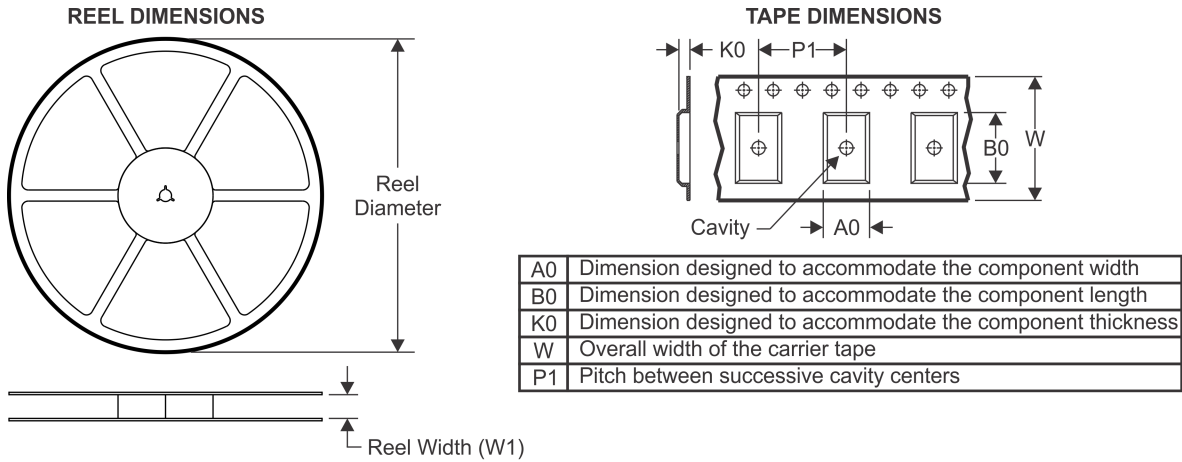
TAPE AND REEL INFORMATION

QUADRANT ASSIGNMENTS FOR PIN 1 ORIENTATION IN TAPE

*All dimensions are nominal

Device	Package Type	Package Drawing	Pins	SPQ	Reel Diameter (mm)	Reel Width W1 (mm)	A0 (mm)	B0 (mm)	K0 (mm)	P1 (mm)	W (mm)	Pin1 Quadrant
LM48310SD/NOPB	WSON	DSC	10	1000	178.0	12.4	3.3	3.3	1.0	8.0	12.0	Q1

TAPE AND REEL BOX DIMENSIONS

*All dimensions are nominal

Device	Package Type	Package Drawing	Pins	SPQ	Length (mm)	Width (mm)	Height (mm)
LM48310SD/NOPB	WSON	DSC	10	1000	210.0	185.0	35.0

IMPORTANT NOTICE AND DISCLAIMER

TI PROVIDES TECHNICAL AND RELIABILITY DATA (INCLUDING DATASHEETS), DESIGN RESOURCES (INCLUDING REFERENCE DESIGNS), APPLICATION OR OTHER DESIGN ADVICE, WEB TOOLS, SAFETY INFORMATION, AND OTHER RESOURCES "AS IS" AND WITH ALL FAULTS, AND DISCLAIMS ALL WARRANTIES, EXPRESS AND IMPLIED, INCLUDING WITHOUT LIMITATION ANY IMPLIED WARRANTIES OF MERCHANTABILITY, FITNESS FOR A PARTICULAR PURPOSE OR NON-INFRINGEMENT OF THIRD PARTY INTELLECTUAL PROPERTY RIGHTS.

These resources are intended for skilled developers designing with TI products. You are solely responsible for (1) selecting the appropriate TI products for your application, (2) designing, validating and testing your application, and (3) ensuring your application meets applicable standards, and any other safety, security, or other requirements. These resources are subject to change without notice. TI grants you permission to use these resources only for development of an application that uses the TI products described in the resource. Other reproduction and display of these resources is prohibited. No license is granted to any other TI intellectual property right or to any third party intellectual property right. TI disclaims responsibility for, and you will fully indemnify TI and its representatives against, any claims, damages, costs, losses, and liabilities arising out of your use of these resources.

TI's products are provided subject to TI's Terms of Sale (www.ti.com/legal/termsofsale.html) or other applicable terms available either on ti.com or provided in conjunction with such TI products. TI's provision of these resources does not expand or otherwise alter TI's applicable warranties or warranty disclaimers for TI products.

Mailing Address: Texas Instruments, Post Office Box 655303, Dallas, Texas 75265
Copyright © 2020, Texas Instruments Incorporated