

## HS401x

High Performance Relative Humidity and Temperature Sensor with Membrane and Digital Output

The HS401x series is a highly accurate, fully calibrated automotive-grade relative humidity and temperature sensor with a hydrophobic membrane. The membrane makes the HS401x dust resistant and waterproof. The MEMS sensor features a proprietary sensor-level protection, ensuring high reliability and long-term stability.

Integrated calibration and temperature-compensation logic provides fully corrected RH and temperature values via a standard I<sup>2</sup>C output. No user calibration of the output data is required.

The high accuracy, fast measurement response time, and long-term stability combined with the small package size makes the HS401x series ideal for a wide number of applications ranging from portable devices to products designed for harsh environments.

The HS401x series digital sensor accurately measures relative humidity and temperature levels. The measured data is internally corrected and compensated for accurate operation over a wide range of temperature and humidity levels – user calibration is not required.

The ultra-low power consumption, micro-Watt, make the HS401x the ideal choice for portable and remote applications.

### Physical Characteristics

- Supply voltage: 1.71V to 3.6V
- Operating temperature: -40°C to +125°C
- 2.5 x 2.5 x 0.9 mm DFN-style 8-LGA package

### Features

- Humidity range: 0% to 100%RH
- Automotive grade, AEC-Q100 qualified, Grade 2, -40°C to +105°C
- Industrial grade, JEDEC qualified, -40°C to +125°C
- Hydrophobic membrane, IP67 rating
- Digital I<sup>2</sup>C output with CRC checksum
- RH accuracy: ±1.5% RH, typical (HS4011)
- 14-bit resolution: 0.04% RH, typical
- Independent programmable resolution settings: 8, 10, 12, 14-bits
- Fast RH response time: 4 seconds time constant, typical
- Temperature sensor accuracy: ±0.2°C, typical (HS4011, HS4012, -10 to +80°C)
- Very low current consumption: 0.3µA average (8-bit resolution, 3.3V supply), 0.62µA average (14-bit resolution, 3.3V supply), one RH and temperature measurement per second
- Excellent stability against aging and volatile compounds
- Highly robust protection from harsh environmental conditions and mechanical shock

### Applications

- Climate control systems
- Instrumentation
- Home appliances
- Weather stations
- Building automation
- HVAC systems
- Medical equipment
- Data logging systems

### Product Image

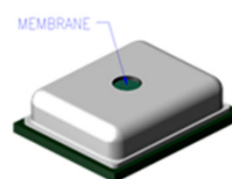

## Contents

<b>1. Pin Information .....</b>	<b>4</b>
1.1 Pin Assignments .....	4
1.2 Pin Descriptions .....	4
<b>2. Specifications .....</b>	<b>5</b>
2.1 Absolute Maximum Ratings .....	5
2.2 Recommended Operating Conditions .....	5
<b>3. Humidity and Temperature Sensor Performance .....</b>	<b>6</b>
3.1 Humidity Sensor Specification .....	6
3.2 Temperature Sensor Specification .....	6
3.3 Humidity Sensor Accuracy Graphs .....	7
3.4 Temperature Sensor Accuracy Graphs .....	8
<b>4. Sensor Interface .....</b>	<b>8</b>
4.1 I <sup>2</sup> C Features and Timing .....	9
4.2 Sensor Slave Address .....	9
4.3 I <sup>2</sup> C Communication .....	9
4.4 Measurements and Commands .....	11
4.4.1. Performing a Hold Measurement .....	11
4.4.2. Performing a No-Hold Measurement .....	12
4.4.3. Calculating Humidity and Temperature Output .....	12
4.4.4. Measurement Conversion Times .....	13
4.4.5. CRC Checksum Calculation .....	13
4.5 Periodic Measurement Mode .....	13
4.6 Alert Feature .....	14
4.7 Accessing Configurable HS401x Registers .....	16
4.7.1. Read Register Command .....	16
4.7.2. Write Register Command .....	17
4.8 Configuration Bits .....	18
4.8.1. Setting the Measurement Resolution .....	18
4.8.2. Periodic Measurement Settings .....	18
4.9 Reading the Sensor ID Number .....	20
<b>5. Application Circuit .....</b>	<b>21</b>
<b>6. Soldering Information .....</b>	<b>21</b>
<b>7. PCB Layout Guide .....</b>	<b>23</b>
<b>8. Storage and Handling .....</b>	<b>23</b>
<b>9. Quality and Reliability .....</b>	<b>23</b>
<b>10. Package Outline Drawings .....</b>	<b>24</b>
<b>11. Ordering Information .....</b>	<b>24</b>
<b>12. Revision History .....</b>	<b>24</b>

## List of Figures

Figure 1. HS4011 RH Accuracy Tolerance at 25°C .....	7
Figure 2. HS4011 RH Accuracy over Temperature.....	7
Figure 3. HS4012 RH Accuracy Tolerance at 25°C .....	7
Figure 4. HS4012 RH Accuracy over Temperature.....	7
Figure 5. HS4013 RH Accuracy Tolerance at 25°C .....	7
Figure 6. HS4013 RH Accuracy over Temperature.....	7
Figure 7. HS4014 RH Accuracy Tolerance at 25°C .....	8
Figure 8. HS4014 RH Accuracy over Temperature.....	8
Figure 9. HS4011/HS4012 Temperature Sensor Accuracy Tolerance .....	8
Figure 10. HS4013 Temperature Sensor Accuracy Tolerance .....	8
Figure 11. HS4014 Temperature Sensor Accuracy Tolerance .....	8
Figure 12. Timing Diagram .....	9
Figure 13. START and STOP Condition Waveform .....	10
Figure 14. Typical Hold Measurement Sequence for a Humidity and Temperature Command .....	11
Figure 15. Typical No-Hold Measurement Sequence for a Humidity and Temperature Command.....	12
Figure 16. Sequence to Retrieve the Latest Results in Periodic Measurement Mode.....	14
Figure 17. Sequence to Stop Periodic Measurements.....	14
Figure 18. Alert Pin Functionality Example.....	15
Figure 19. Data Returned from HS401x when the Alert Feature is Enabled in Periodic Measurement Mode .....	16
Figure 20. Read Register command sequence .....	17
Figure 21. Write Register Command Sequence.....	17
Figure 22. Read Sensor ID Command Sequence .....	21
Figure 23. HS401x Application Circuit (Top View) .....	21
Figure 24. Recommended Soldering Profile.....	22
Figure 25. Milled PCB Openings for Thermal Isolation .....	23

## List of Tables

Table 1. Humidity Sensor Specification, $T_A = +25^\circ\text{C}$ , $V_{DD} = 1.71\text{V}$ to $3.6\text{V}$ .....	6
Table 2. Temperature Sensor Specification, $T_A = +25^\circ\text{C}$ , $V_{DD} = 1.71\text{V}$ to $3.6\text{V}$ .....	6
Table 3. I <sup>2</sup> C Timing Parameters .....	9
Table 4. Commands Code and Description.....	10
Table 5. Measurement Command Modes .....	10
Table 6. Conversion Times.....	13
Table 7. CRC Checksum Properties .....	13
Table 8. Alert Status Bits .....	15
Table 9. Temperature and Humidity Measurement Resolution Settings.....	18
Table 10. Periodic Measurement Settings.....	18
Table 11. Alert Feature Settings.....	18

# 1. Pin Information

## 1.1 Pin Assignments

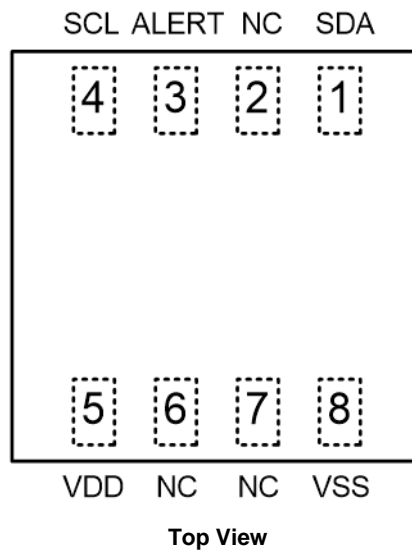

## 1.2 Pin Descriptions

Pin Number	Pin Name	Type	Description
1	SDA	In/Out	Serial data.
2	NC <sup>[1]</sup>	-	Do not connect.
3	ALERT	Out	Digital output indicating an alarm condition. Leave floating if unused.
4	SCL	In/Out	Serial clock.
5	VDD	In	Supply voltage.
6	NC <sup>[1]</sup>	-	Do not connect.
7	NC <sup>[1]</sup>	-	Do not connect.
8	VSS	In	Ground.

1. "NC" stands for not connected / no connection required / not bonded.

## 2. Specifications

### 2.1 Absolute Maximum Ratings

**CAUTION:** The absolute maximum ratings are stress ratings only. Stresses greater than those listed below can cause permanent damage to the device. Functional operation of the HS401x at absolute maximum ratings is not implied. Exposure to absolute maximum rating conditions might affect device reliability.

Parameter	Conditions	Minimum	Maximum	Unit
Storage Temperature Range	Recommended 0 to 60°C	-40	125	°C

### 2.2 Recommended Operating Conditions

Important note: The HS401x series sensors are optimized to perform best in the more common temperature and humidity ranges of 10°C to 50°C and 20% RH to 80% RH, respectively. If operated outside of these conditions for extended periods, especially at high humidity levels, the sensors may exhibit an offset. In most cases, this offset is temporary and will gradually disappear once the sensor is returned to normal temperature and humidity conditions. The amount of the shift and the duration of the offset vary depending on the duration of exposure and the severity of the relative humidity and temperature conditions.<sup>[1]</sup> The time needed for the offset to disappear can also be decreased by using the procedures described in sections 8 and 9.

Parameter	Condition		Minimum	Typical	Maximum	Unit
Operating Supply Voltage	-		1.71	3.3	3.6	V
Sleep Current	Sleep Mode	25°C	-	0.010	0.025	μA
		-40 to 125°C	-	-	2.5	
Average Current	One RH + temperature measurement/second V <sub>DD</sub> = 3.3V	8-bit resolution	0.27	0.30	0.32	μA
		10-bit resolution	0.31	0.34	0.37	
		12-bit resolution	0.39	0.43	0.47	
		14-bit resolution	0.55	0.62	0.69	
Measurement Time	Humidity and temperature including the digital compensation	8-bit resolution	-	0.64	-	ms
		10-bit resolution	-	0.80	-	
		12-bit resolution	-	1.04	-	
		14-bit resolution	-	1.70	-	
Operating Temperature Range	-		-40	-	125	°C

1. At T<sub>A</sub> = +25°C, V<sub>DD</sub> = +1.71V to +3.6V unless otherwise noted.

### 3. Humidity and Temperature Sensor Performance

#### 3.1 Humidity Sensor Specification

Table 1. Humidity Sensor Specification,  $T_A = +25^{\circ}\text{C}$ ,  $V_{DD} = 1.71\text{V}$  to  $3.6\text{V}$

Parameter	Condition		Minimum	Typical	Maximum	Unit
Range	-		0	-	100	%RH
Accuracy <sup>[1][2]</sup>	HS4011	10% to 90%RH	-	±1.5	±1.8	%RH
	HS4012		-	±1.8	±2.0	
	HS4013	20% to 80%RH	-	±2.5	±3.5	
	HS4014		-	±3.5	±4.5	
Resolution	14-bit		-	0.04	0.05	%RH
Hysteresis	-		-	-	±1.0	%RH
Non-Linearity from Response Curve	HS4011	10% to 90%RH	-	±0.15	±0.25	%RH
	HS4012					
	HS4013	20% to 80%RH				
	HS4014					
Long-Term Stability	-		-	±0.1	±0.25	%RH/Yr
Response Time Constant <sup>[3]</sup> ( $\tau_H$ )	20% to 80% RH Still Air		3.0	4.0	6.0	sec

1. Monotonic increases from 10 to 90% RH after sensor has been stabilized at 50% RH.
2. Refer to section 3.3 for additional details.
3. Initial value to 63% of total variation. Response time depend on system airflow.

#### 3.2 Temperature Sensor Specification

Table 2. Temperature Sensor Specification,  $T_A = +25^{\circ}\text{C}$ ,  $V_{DD} = 1.71\text{V}$  to  $3.6\text{V}$

Parameter	Condition		Minimum	Typical	Maximum	Unit
Range	-		-40	-	125	°C
Accuracy <sup>[1]</sup>	HS4011	-10°C to 80°C	-	±0.2	±0.3	°C
	HS4012					
	HS4013	0°C to 70°C				
	HS4014					
Resolution	14-bit		-	0.01	0.02	°C
Response Time Constant <sup>[2]</sup> ( $\tau_T$ )	-		-	>2.0	-	Sec.
Long-Term Stability	-		-	-	0.03	°C/Yr
Supply Voltage Dependency <sup>[3]</sup>	-		-	0.03	0.1	°C/V

1. Refer to section 3.4 for additional details.
2. Initial value to 63% of total variation. Response time depends on system thermal mass and air flow.
3. Temperature accuracy can be optimized for specified supply voltages upon request.

### 3.3 Humidity Sensor Accuracy Graphs

The typical and maximum relative humidity sensor accuracy tolerances are shown in the following figures.

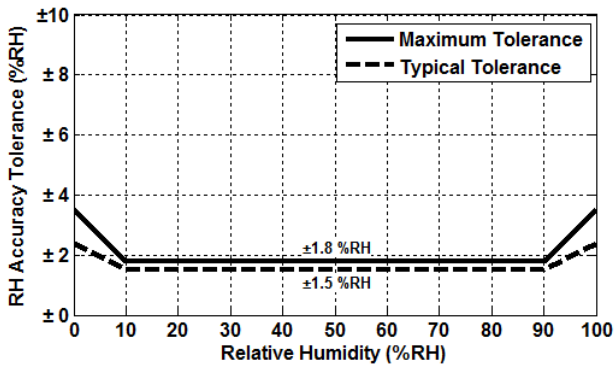

Figure 1. HS4011 RH Accuracy Tolerance at 25°C

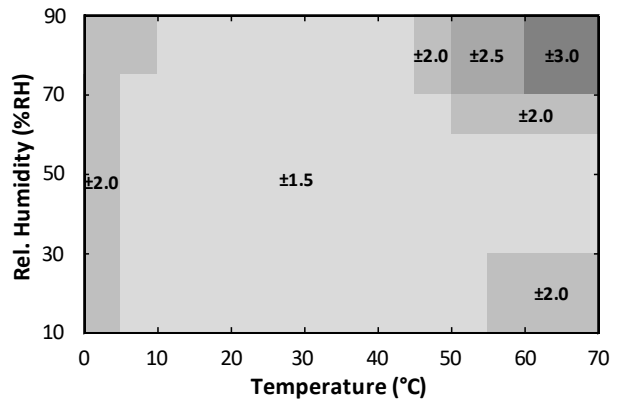

Figure 2. HS4011 RH Accuracy over Temperature

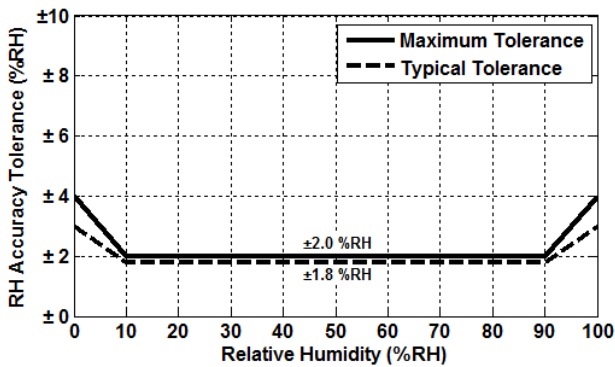

Figure 3. HS4012 RH Accuracy Tolerance at 25°C

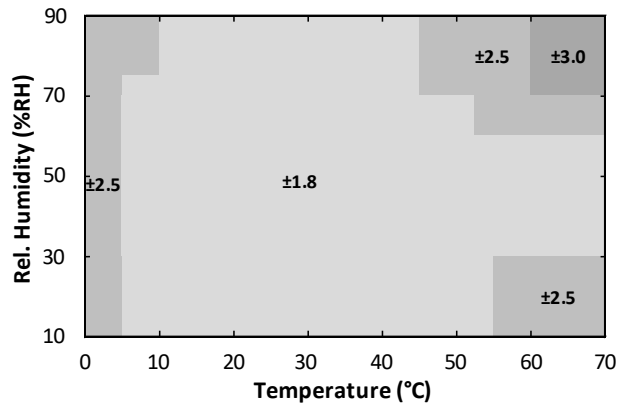

Figure 4. HS4012 RH Accuracy over Temperature

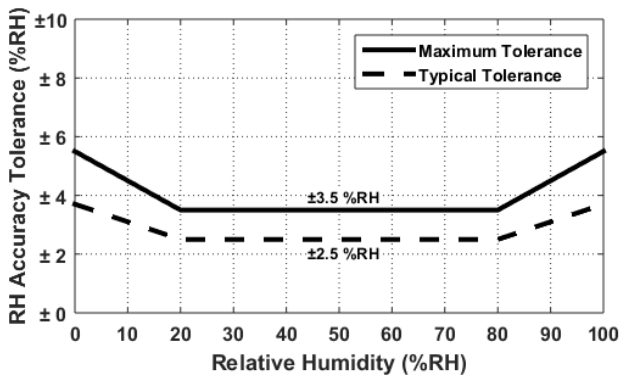

Figure 5. HS4013 RH Accuracy Tolerance at 25°C

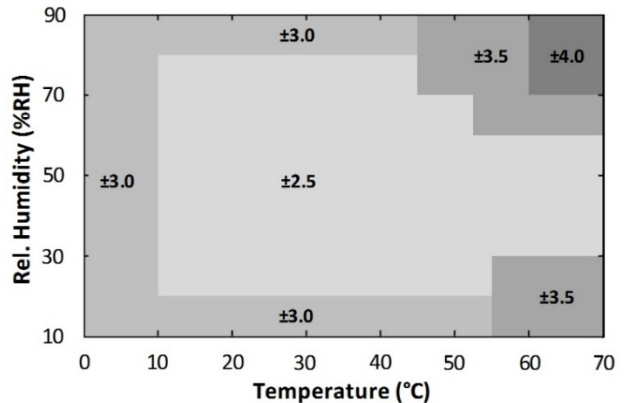

Figure 6. HS4013 RH Accuracy over Temperature

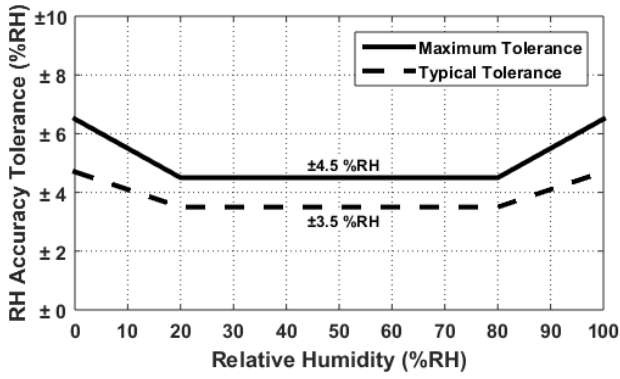

Figure 7. HS4014 RH Accuracy Tolerance at 25°C

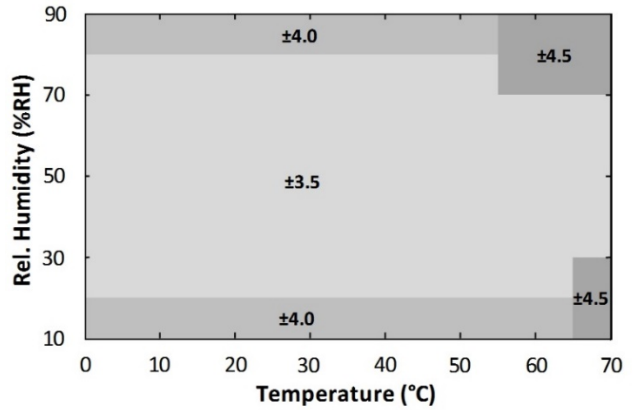

Figure 8. HS4014 RH Accuracy over Temperature

### 3.4 Temperature Sensor Accuracy Graphs

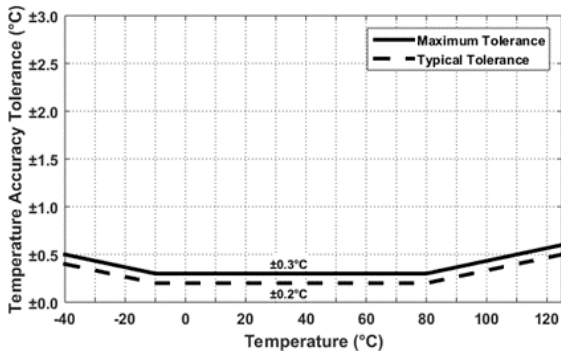

Figure 9. HS4011/HS4012 Temperature Sensor Accuracy Tolerance

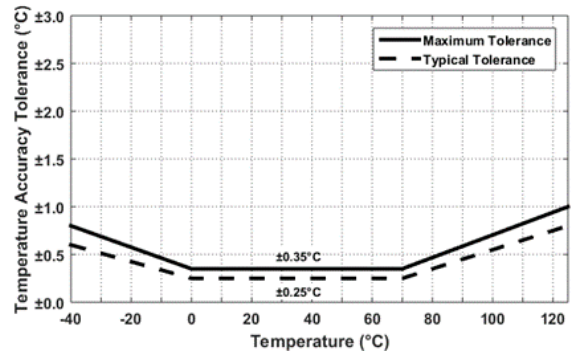

Figure 10. HS4013 Temperature Sensor Accuracy Tolerance

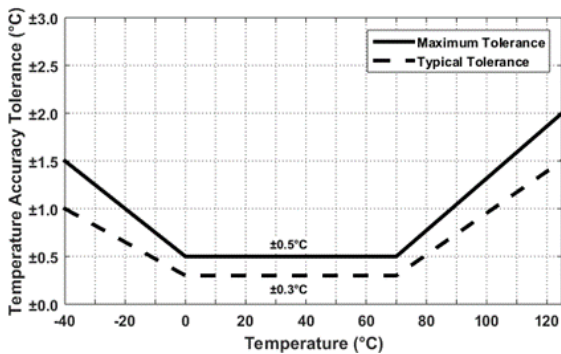

Figure 11. HS4014 Temperature Sensor Accuracy Tolerance

## 4. Sensor Interface

The HS401x series sensor uses a digital I<sup>2</sup>C-compatible communication protocol. To accommodate multiple devices, the protocol uses two bi-directional open-drain lines: the Serial Data Line (SDA) and the Serial Clock Line (SCL). Pull-up resistors to V<sub>DD</sub> are required. Several slave devices can share the bus; however only one master device can be present on the line.



## 4.1 I<sup>2</sup>C Features and Timing

The HS401x series sensor operates as a slave device on the I<sup>2</sup>C bus with support for 100kHz and 400kHz bit rates. Each transmission is initiated when the master sends a 0 START bit (S), and the transmission is terminated when the master sends a 1 STOP bit (P). These bits are exclusively transmitted while the SCL line is high.

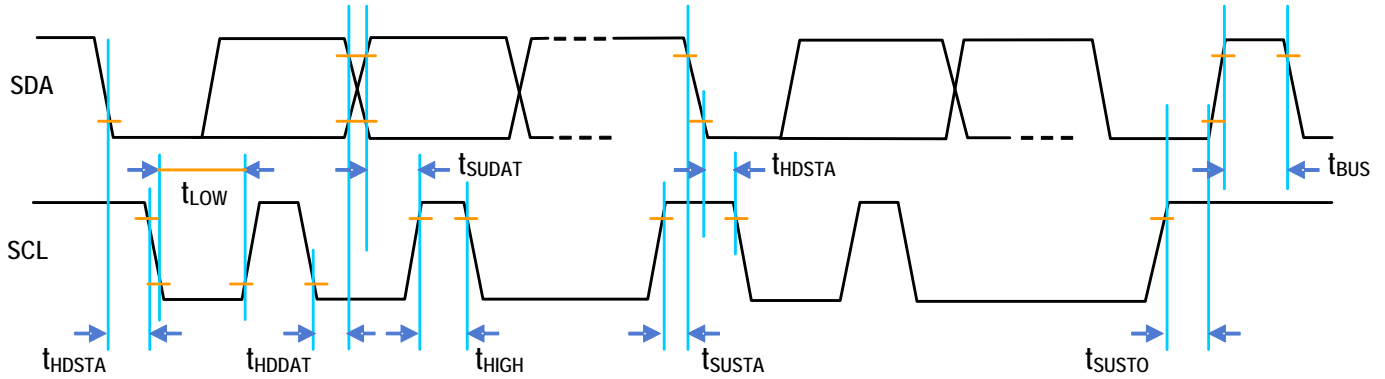

Figure 12. Timing Diagram

Table 3. I<sup>2</sup>C Timing Parameters

Parameter	Symbol	Minimum	Typical	Maximum	Units
SCL Clock Frequency	$f_{SCL}$	0	-	400	kHz
START Condition Hold Time Relative to SCL Edge	$t_{HDSTA}$	0.1	-	-	$\mu s$
Minimum SCL Clock LOW Width <sup>[1]</sup>	$t_{LOW}$	0.6	-	-	$\mu s$
Minimum SCL Clock HIGH Width <sup>[1]</sup>	$t_{HIGH}$	0.6	-	-	$\mu s$
START Condition Setup Time Relative to SCL Edge	$t_{SUSTA}$	0.1	-	-	$\mu s$
Data Hold Time on SDA Relative to SCL Edge	$t_{HDDAT}$	0	-	0.5	$\mu s$
Data Setup Time on SDA Relative to SCL Edge	$t_{SUDAT}$	0.1	-	-	$\mu s$
STOP Condition Setup Time on SCL	$t_{SUSTO}$	0.1	-	-	$\mu s$
Bus Free Time Between STOP Condition and START Condition	$t_{BUS}$	1	-	-	$\mu s$

1. Combined LOW and HIGH widths must equal or exceed the minimum SCL period.

## 4.2 Sensor Slave Address

The HS401x series default I<sup>2</sup>C address is 54<sub>HEX</sub>. The device will respond only to this 7-bit address. See section 0 for further information.

## 4.3 I<sup>2</sup>C Communication

The sensor transmission is initiated when the master sends a 0 START bit (S). The transmission is terminated when the master sends a 1 STOP bit (P). These bits are only transmitted while the SCL line is HIGH (see Figure 13 for waveforms).

Once the START condition has been set, the SCL line is toggled at the prescribed data rate, clocking subsequent data transfers. Data on the SDA line is always sampled on the rising edge of the SCL line and must remain stable while SCL is HIGH to prevent false START or STOP conditions.

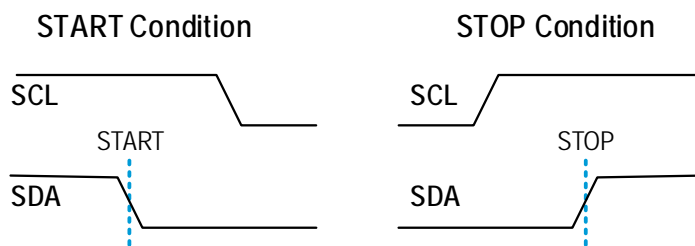

Figure 13. START and STOP Condition Waveform

After the START bit, the master device sends the 7-bit slave address (see section 4.2) to the HS401x, followed by the read/write bit, which indicates the transfer direction of any subsequent data. This bit is set to 1 to indicate a read from slave to master or set to 0 to indicate a write from master to slave.

All transfers consist of 8 bits and a response bit: 0 for Acknowledge (ACK) or 1 for Not Acknowledge (NACK). After the ACK is received, another data byte can be transferred or the communication can be stopped with a STOP bit.

The HS401x series sensors are equipped with different commands to configure the chip and to perform measurement as described in Table 4.

Table 4. Commands Code and Description

Command Code (HEX)	Description
0xE3	Hold Temperature Measurement
0xF3	No-hold Temperature Measurement
0xE5	Hold Humidity and Temperature Measurement
0xF5	No-hold Humidity and Temperature Measurement
0xA7	Read Register
0xA6	Write Register
0x30	Stop Periodic Measurements
0xD7	Read Sensor ID

The Hold and No-hold commands will be described in section 0, and the read and write register commands will be described in section 4.7. The HS401x sensor can measure only temperature or both humidity and temperature as described in Table 8. Both options return fully calibrated measurements that can be converted to humidity and temperature readings using the equations in section 4.4.3.

Table 5. Measurement Command Modes

Measurement Command Mode	Description	Number of data bytes sent on the I2C bus
Temperature	The chip only measures temperature and sends the 14-bit result once the measurement is complete.	2 bytes + 1 byte CRC
Humidity and Temperature	The chip measures humidity and temperature and sends the 14-bit humidity result followed by the 14-bit temperature result once the measurement is complete.	4 bytes + 1 byte CRC

## 4.4 Measurements and Commands

There are two types of measurement commands:

1. Hold measurement commands: The HS401x series sensor holds the SCL line low during the measurement and releases the SCL line when the measurement is complete. This lets the master know exactly when the measurement has finished. Using this mode will prevent the master from communicating with any other slave until the measurement is complete. Note that the minimum frequency for the SCL clock in this mode is 200kHz.
2. No-hold measurement commands: The HS401x series sensor does not hold the SCL line low, and the master is free to initiate communication with other slaves while the chip is performing the measurement. To obtain the measurement data, the master must request the result from the chip after the expected conversion time which depends on the measurement resolution as summarized in section 4.4.4. There is no minimum clock frequency when in this mode.

### 4.4.1. Performing a Hold Measurement

A hold measurement sequence consists of the following steps, as illustrated in Figure 14.

1. Wake up the HS401x series sensor from sleep mode by sending its I<sup>2</sup>C address with a write bit, and initiate a measurement by sending the desired hold measurement command.
2. Change the direction of communication by sending a start bit, the HS401x I<sup>2</sup>C address, and a read bit. The SCL line is held low by the sensor during the measurement process, which prevents the master from initiating any communications with other slaves on the bus.
3. Once the requested measurement is completed by the HS401x series sensor, the SCL line is released and the chip waits for the SCL clock signal to send the results. The sensor will then transmit the requested measurement data on the bus for the master to capture.

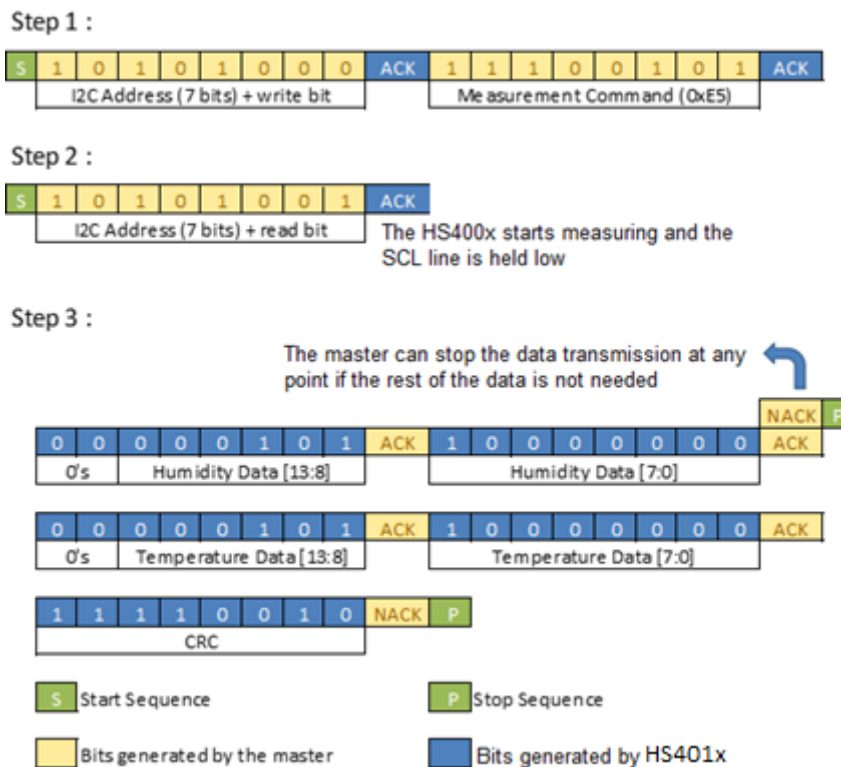

Figure 14. Typical Hold Measurement Sequence for a Humidity and Temperature Command

### 4.4.2. Performing a No-Hold Measurement

A no-hold measurement sequence consists of the following steps, as illustrated in Figure 15.

1. Wake up the HS401x series sensor from sleep mode by sending its I<sup>2</sup>C address with a write bit, and initiate a measurement by sending the desired no-hold measurement command.
2. To read the result from the HS401x series sensor, the master has to send the chip its I<sup>2</sup>C address and a read bit. If the measurement is completed and the result is ready, the chip will send an ACK bit and starts to send the result over the bus. If the measurement is still in progress, the chip will send a NACK bit and the master will need to try to read the result again.

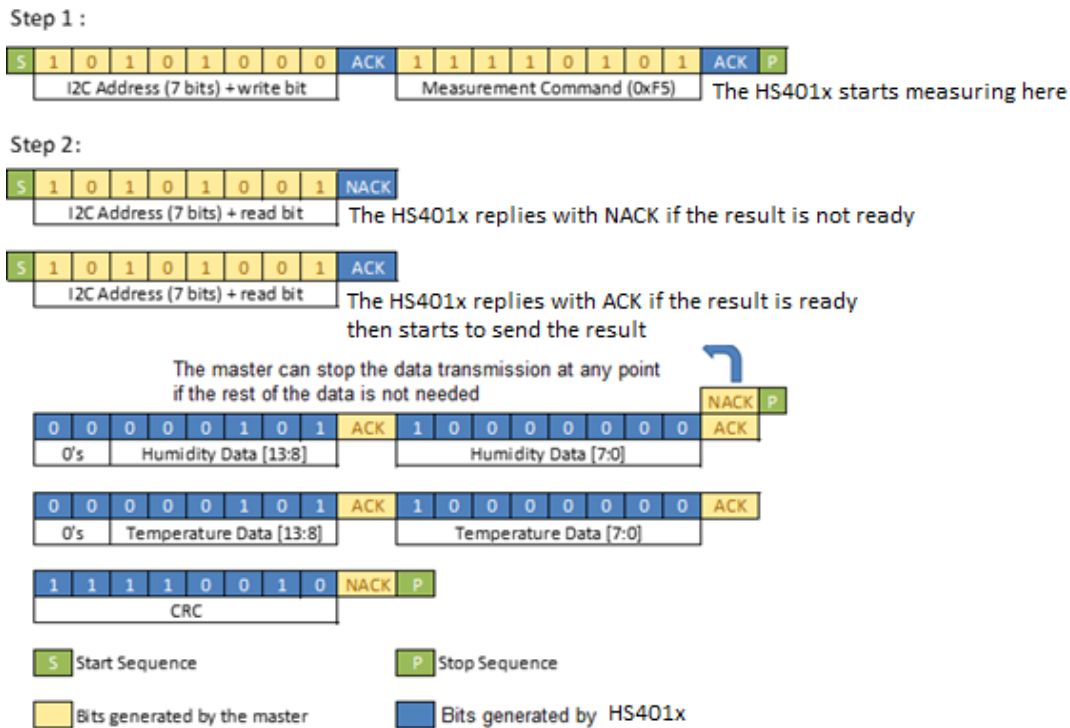

Figure 15. Typical No-Hold Measurement Sequence for a Humidity and Temperature Command

### 4.4.3. Calculating Humidity and Temperature Output

As stated in Table 5, the measurement data can either be two or four bytes long depending on whether a temperature measurement or a humidity and temperature measurement was initiated. The most significant bit of the reading is sent first followed by the least significant bits. The humidity and temperature measurements are always scaled up to a 14-bit value regardless of the selected resolution of the sensor. The relative humidity (in percent) and the temperature (in degrees Celsius) are obtained as follows:

The relative humidity (in percent) and the temperature (in degrees Celsius) are calculated with Equation 1 and Equation 2, respectively.

$$Humidity [\%RH] = \frac{Humidity[13:0]}{2^{14} - 1} * 100 \tag{Equation 1}$$

$$Temperature [^{\circ}C] = \frac{Temperature [13:0]}{2^{14} - 1} * 165 - 40 \tag{Equation 2}$$

#### 4.4.4. Measurement Conversion Times

The HS401x series sensors are designed to have relatively fast conversion times. The conversion time depends on the resolution of the measurement and the command type (temperature or humidity and temperature). Table 6 summarizes the conversion times for different resolutions.

**Table 6. Conversion Times**

Measurement	Resolution(bits)	Measurement Time (ms)
Temperature	8	0.37
	10	0.45
	12	0.60
	14	0.91
Humidity and Temperature <sup>[1]</sup>	8	0.64
	10	0.80
	12	1.04
	14	1.70

1. Assuming the same resolution settings for both humidity and temperature measurements.

#### 4.4.5. CRC Checksum Calculation

An 8-bit CRC checksum is transmitted after each measurement so the user can check for data corruption during communications if desired. The properties of the CRC algorithm used are summarized in Table 7, and the CRC is based on all 4 bytes of measurement data (2 bytes of humidity data followed by 2 bytes of temperature data). For temperature-only measurements, the 2 bytes of humidity data are set to be all 0's for the CRC calculation.

**Table 7. CRC Checksum Properties**

Property	Value
Input Data Width	32 bits
CRC Width	8 bits
Polynomial	0x1D ( $x^8 + x^4 + x^3 + x^2 + 1$ )
Initial Value	0xFF
Final XOR Value	0x00
Reflect Input	No
Reflect Output	No
Example	CRC (0x05800580) = 0xF2

### 4.5 Periodic Measurement Mode

The HS401x sensors can also be configured to measure at regular intervals without user intervention, and the process to enable this mode is described in section 4.8.2. In this mode, the user can read the latest relative humidity / temperature data by issuing a data fetch sequence, which consists of sending the HS401x I<sup>2</sup>C address with a read bit. The sensor will then send the latest measurement result over the I<sup>2</sup>C bus. The data fetch sequence is illustrated in Figure 16.

Step 1 :

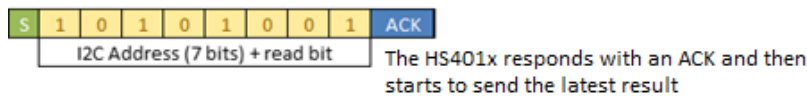

Step 2:

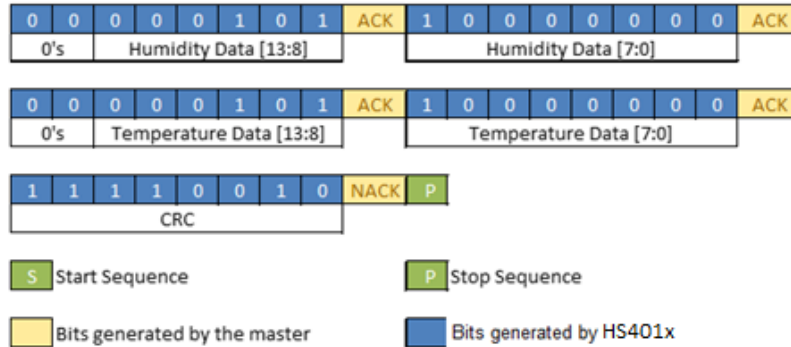

Figure 16. Sequence to Retrieve the Latest Results in Periodic Measurement Mode

The frequency of the periodic measurements can be set using the configuration registers. Section 4.7 describes how these registers are accessed, and section 4.8.2 provides the register settings needed to configure and activate the periodic measurements.

When the periodic measurement mode is active, the only commands the chip will respond to are the data fetch command, and a command to stop the periodic measurements. The command to stop periodic measurements is issued by sending the I<sup>2</sup>C address with a write bit, followed by the command 0x30, as shown in Figure 17. Once the periodic measurements have been stopped, the chip returns to sleep and is ready to accept all valid I<sup>2</sup>C commands.

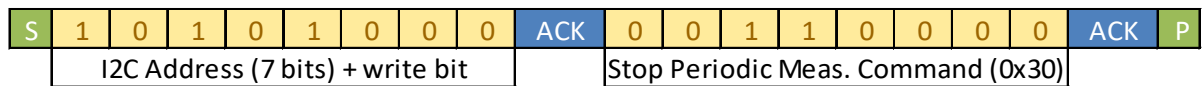

Figure 17. Sequence to Stop Periodic Measurements

### 4.6 Alert Feature

The HS401x sensors have an optional Alert feature that can be used to trigger an interrupt on the system microcontroller so an appropriate action can be taken if the temperature or humidity is outside of the desired limits. This feature is available in Periodic Measurement Mode.

The Alert feature has a programmable threshold, polarity, and hysteresis, and can apply to both temperature and humidity measurements. An example of the functionality of the Alert feature can be seen in Figure 18.

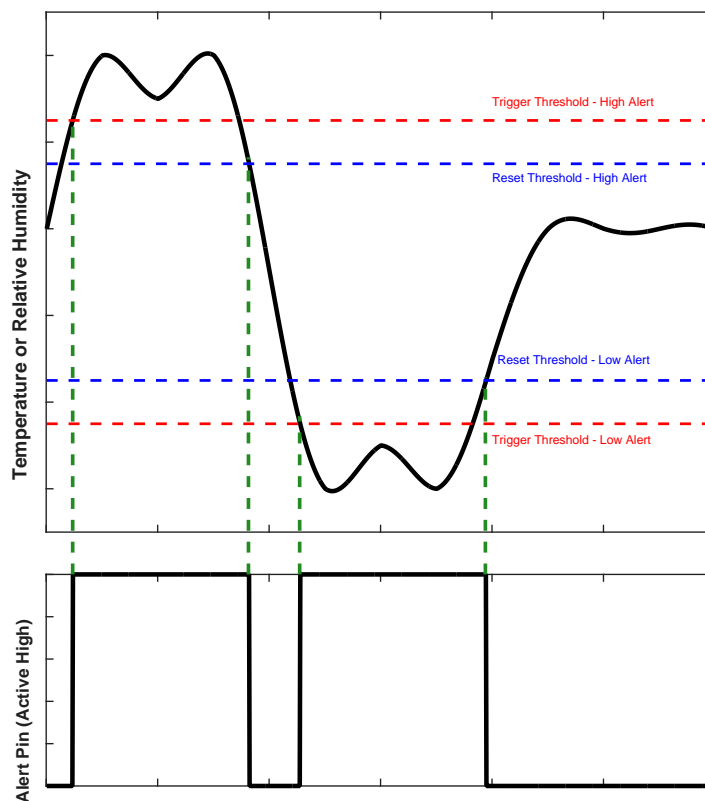

Figure 18. Alert Pin Functionality Example

The registers used to enable the Alert feature and the temperature / humidity thresholds are shown in Table 11. When the Alert feature is enabled for either humidity or temperature in Periodic Measurement Mode, an additional status byte will precede the measurement values. The format of the bits returned from the HS401x sensor when any Alert is enabled is shown in Figure 19, and the meaning of the Alert status bits are defined in Table 8.

Table 8. Alert Status Bits

Status Bit	Meaning
TH	High (0b1) if the Temperature High Alert is triggered
TL	High (0b1) if the Temperature Low Alert is triggered
HH	High (0b1) if the Humidity High Alert is triggered
HL	High (0b1) if the Humidity Low Alert is triggered

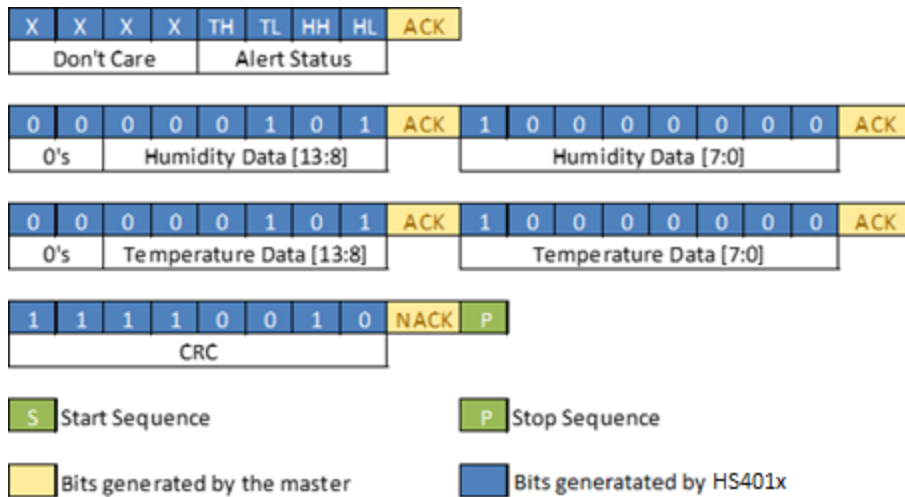

Figure 19. Data Returned from HS401x when the Alert Feature is Enabled in Periodic Measurement Mode

## 4.7 Accessing Configurable HS401x Registers

The HS401x measurement settings can be changed by accessing the appropriate configuration registers and altering their values. This can be done by issuing a Write Register command. A Read Register command is also available to read the configuration register values. These commands will be described in this section, and the configuration registers and settings will be described in section 4.8.

While accessing specific configuration bits in any register, all the other bits in that register must be left unchanged. To write a specific bit/bits in a register, the process is as follows:

1. Read the entire configuration register using the sequence described in section 4.7.1.
2. Mask the register such that only the required bits are changed, according to the configuration parameters in section 4.8.
3. Write the new register back to the appropriate address using the Write Register command sequence described in section 4.7.2.

All configuration registers will be reset to their default values if the power supply to the chip is cutoff.

### 4.7.1. Read Register Command

A Read Register sequence consists of the following steps, as illustrated in Figure 20.

1. Wake up the HS401x series sensor from sleep mode by sending its I2C address with a write bit, and initiate a Read Register command by sending the command 0xA7.
2. Send the address of the register to be read.
3. Change the direction of communication by sending the HS401x I2C address and a read bit. The chip will send the data stored in this register, after which the master replies with a NACK and a STOP bit.



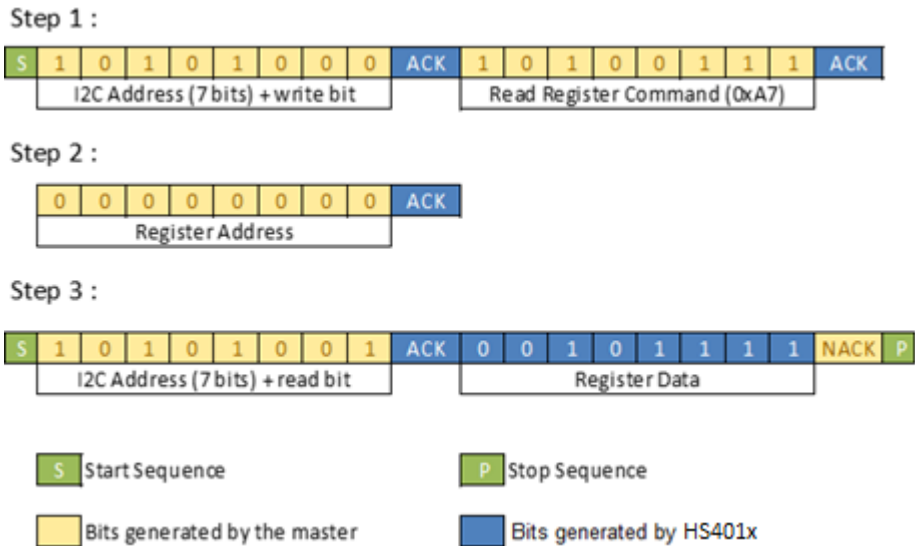

Figure 20. Read Register command sequence

### 4.7.2. Write Register Command

A Write Register sequence consists of the following steps, as illustrated in Figure 21.

1. Wake up the HS401x series sensor from sleep mode by sending its I2C address with a write bit, and initiate a Write Register command by sending the command 0xA6.
2. Send the address of the register to write.
3. Send the data to be stored in this register followed by a STOP bit.

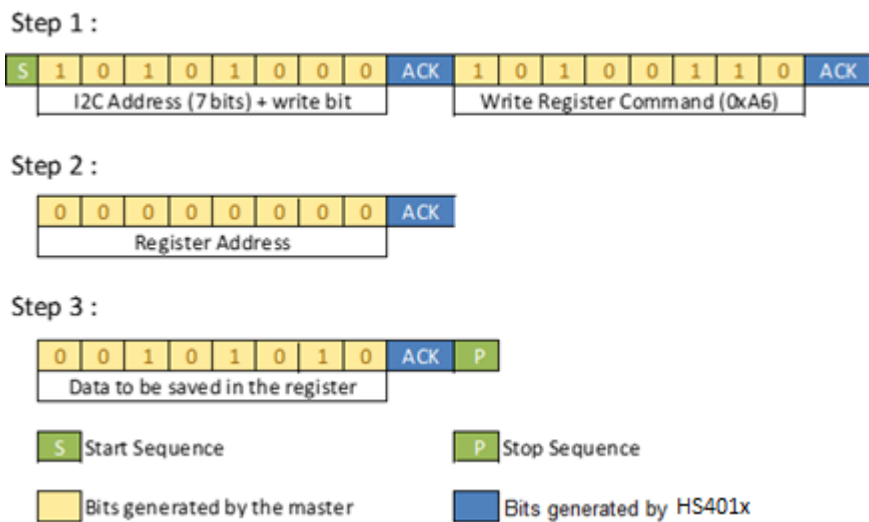

Figure 21. Write Register Command Sequence

## 4.8 Configuration Bits

### 4.8.1. Setting the Measurement Resolution

The chip can be configured to perform measurements at different humidity and temperature resolutions by using the Read and Write Register commands with the appropriate register address. There are four separate resolution settings for the temperature and humidity measurements, as summarized in Table 9.

**Table 9. Temperature and Humidity Measurement Resolution Settings**

Setting	Register Address (HEX)	Bits	Description
Resolution for Temperature Measurement	0x00	<1:0>	0b00 for 8 bits
			0b01 for 10 bits
			0b10 for 12 bits
			0b11 for 14 bits
Resolution for Humidity Measurement	0x00	<3:2>	0b00 for 8 bits
			0b01 for 10 bits
			0b10 for 12 bits
			0b11 for 14 bits

### 4.8.2. Periodic Measurement Settings

The registers that are used to activate and configure the periodic measurement settings are shown in Table 10.

**Table 10. Periodic Measurement Settings**

Setting	Register Address (HEX)	Bits	Description
Activate Periodic Measurements	0x02	<7>	0b0 when periodic measurements are deactivated
			0b1 to activate periodic measurements
Frequency of Periodic Measurements	0x02	<5:4>	0b00 for a measurement every 0.5s
			0b01 for a measurement every 1s
			0b10 for a measurement every 2.5s

**Table 11. Alert Feature Settings**

Setting	Register Address (HEX)	Bits	Description
Alert Pin Polarity	0x02	<0>	0b0 Alert pin is active high when triggered
			0b1 Alert pin is active low when triggered
Alert Enable Settings	0x03	<3:0>	<p>Enable the Alert feature when thresholds are surpassed as follows:</p> <p>Bit &lt;0&gt;: RH Low alert enable                      Bit &lt;1&gt;: RH High alert enable                      Bit &lt;2&gt;: Temperature Low alert enable                      Bit &lt;3&gt;: Temperature High alert enable</p> <p>Setting a bit to 0b1 means this specific alert condition is enabled and setting a bit to 0b0 means this specific alert condition is disabled.</p>

Setting	Register Address (HEX)	Bits	Description																																																						
Trigger Threshold for Temperature High Alert	0x08, 0x07	<13:0>	<p>Registers 0x08, 0x07 set the threshold for when the “Temperature High” alert is triggered. When the measured temperature goes above the value in this register, the Alert pin will be triggered.</p> <p>The temperature used for the threshold is composed of 14-bits as follows:</p> <table border="1"> <tr> <td colspan="7">Register 0x08</td> <td colspan="7">Register 0x07</td> </tr> <tr> <td>0</td><td>0</td><td>0</td><td>0</td><td>0</td><td>0</td><td>1</td><td>0</td><td>1</td><td>1</td><td>0</td><td>0</td><td>0</td><td>0</td><td>0</td><td>0</td><td>0</td><td>0</td><td>0</td> </tr> <tr> <td colspan="7">0's</td> <td colspan="7">Trigger Threshold [13:8]</td> <td colspan="7">Trigger Threshold [7:0]</td> </tr> </table> <p>This 14-bit value is converted into a temperature threshold using the same conversion equation shown in section 4.4.3.</p>	Register 0x08							Register 0x07							0	0	0	0	0	0	1	0	1	1	0	0	0	0	0	0	0	0	0	0's							Trigger Threshold [13:8]							Trigger Threshold [7:0]						
Register 0x08							Register 0x07																																																		
0	0	0	0	0	0	1	0	1	1	0	0	0	0	0	0	0	0	0																																							
0's							Trigger Threshold [13:8]							Trigger Threshold [7:0]																																											
Reset Threshold for Temperature High Alert	0x06, 0x05	<13:0>	<p>Registers 0x06, 0x05 set the threshold for when the “Temperature High” alert condition is reset. After the alert is triggered, it will only be reset after the measured temperature goes below the value in this register.</p> <p>The temperature used for the threshold is composed of 14-bits as follows:</p> <table border="1"> <tr> <td colspan="7">Register 0x06</td> <td colspan="7">Register 0x05</td> </tr> <tr> <td>0</td><td>0</td><td>0</td><td>0</td><td>0</td><td>0</td><td>1</td><td>0</td><td>1</td><td>1</td><td>0</td><td>0</td><td>0</td><td>0</td><td>0</td><td>0</td><td>0</td><td>0</td><td>0</td> </tr> <tr> <td colspan="7">0's</td> <td colspan="7">Reset Threshold [13:8]</td> <td colspan="7">Reset Threshold [7:0]</td> </tr> </table> <p>This 14-bit value is converted into a temperature threshold using the same conversion equation shown in section 4.4.3.</p>	Register 0x06							Register 0x05							0	0	0	0	0	0	1	0	1	1	0	0	0	0	0	0	0	0	0	0's							Reset Threshold [13:8]							Reset Threshold [7:0]						
Register 0x06							Register 0x05																																																		
0	0	0	0	0	0	1	0	1	1	0	0	0	0	0	0	0	0	0																																							
0's							Reset Threshold [13:8]							Reset Threshold [7:0]																																											
Trigger Threshold for Temperature Low Alert	0x0A, 0x09	<13:0>	<p>Registers 0x0A, 0x09 set the threshold for when the “Temperature Low” alert is triggered. When the measured temperature goes below the value in this register, the Alert pin will be triggered.</p> <p>The temperature used for the threshold is composed of 14-bits as follows:</p> <table border="1"> <tr> <td colspan="7">Register 0x0A</td> <td colspan="7">Register 0x09</td> </tr> <tr> <td>0</td><td>0</td><td>0</td><td>0</td><td>0</td><td>0</td><td>1</td><td>0</td><td>1</td><td>1</td><td>0</td><td>0</td><td>0</td><td>0</td><td>0</td><td>0</td><td>0</td><td>0</td><td>0</td> </tr> <tr> <td colspan="7">0's</td> <td colspan="7">Trigger Threshold [13:8]</td> <td colspan="7">Trigger Threshold [7:0]</td> </tr> </table> <p>This 14-bit value is converted into a temperature threshold using the same conversion equation shown in section 4.4.3.</p>	Register 0x0A							Register 0x09							0	0	0	0	0	0	1	0	1	1	0	0	0	0	0	0	0	0	0	0's							Trigger Threshold [13:8]							Trigger Threshold [7:0]						
Register 0x0A							Register 0x09																																																		
0	0	0	0	0	0	1	0	1	1	0	0	0	0	0	0	0	0	0																																							
0's							Trigger Threshold [13:8]							Trigger Threshold [7:0]																																											
Reset Threshold for Temperature Low Alert	0x0C, 0x0B	<13:0>	<p>Registers 0x0C, 0x0B set the threshold for when the “Temperature Low” alert condition is reset. After the alert is triggered, it will only be reset after the measured temperature goes above the value in this register.</p> <p>The temperature used for the threshold is composed of 14-bits as follows:</p> <table border="1"> <tr> <td colspan="7">Register 0x0C</td> <td colspan="7">Register 0x0B</td> </tr> <tr> <td>0</td><td>0</td><td>0</td><td>0</td><td>0</td><td>0</td><td>1</td><td>0</td><td>1</td><td>1</td><td>0</td><td>0</td><td>0</td><td>0</td><td>0</td><td>0</td><td>0</td><td>0</td><td>0</td> </tr> <tr> <td colspan="7">0's</td> <td colspan="7">Reset Threshold [13:8]</td> <td colspan="7">Reset Threshold [7:0]</td> </tr> </table> <p>This 14-bit value is converted into a temperature threshold using the same conversion equation shown in section 4.4.3.</p>	Register 0x0C							Register 0x0B							0	0	0	0	0	0	1	0	1	1	0	0	0	0	0	0	0	0	0	0's							Reset Threshold [13:8]							Reset Threshold [7:0]						
Register 0x0C							Register 0x0B																																																		
0	0	0	0	0	0	1	0	1	1	0	0	0	0	0	0	0	0	0																																							
0's							Reset Threshold [13:8]							Reset Threshold [7:0]																																											
Trigger Threshold for Relative Humidity High Alert	0x10, 0x0F	<13:0>	<p>Registers 0x10, 0x0F set the threshold for when the “RH High” alert is triggered. When the measured RH goes above the value in this register, the Alert pin will be triggered.</p> <p>The humidity used for the threshold is composed of 14-bits as follows:</p> <table border="1"> <tr> <td colspan="7">Register 0x10</td> <td colspan="7">Register 0x0F</td> </tr> <tr> <td>0</td><td>0</td><td>0</td><td>0</td><td>0</td><td>0</td><td>1</td><td>0</td><td>1</td><td>1</td><td>0</td><td>0</td><td>0</td><td>0</td><td>0</td><td>0</td><td>0</td><td>0</td><td>0</td> </tr> <tr> <td colspan="7">0's</td> <td colspan="7">Trigger Threshold [13:8]</td> <td colspan="7">Trigger Threshold [7:0]</td> </tr> </table> <p>This 14-bit value is converted into a humidity threshold using the same conversion equation shown in section 4.4.3.</p>	Register 0x10							Register 0x0F							0	0	0	0	0	0	1	0	1	1	0	0	0	0	0	0	0	0	0	0's							Trigger Threshold [13:8]							Trigger Threshold [7:0]						
Register 0x10							Register 0x0F																																																		
0	0	0	0	0	0	1	0	1	1	0	0	0	0	0	0	0	0	0																																							
0's							Trigger Threshold [13:8]							Trigger Threshold [7:0]																																											

Setting	Register Address (HEX)	Bits	Description																																																										
Reset Threshold for Relative Humidity High Alert	0x0E, 0x0D	<13:0>	<p>Registers 0x0E, 0x0D set the threshold for when the “RH High” alert condition is reset. After the alert is triggered, it will only be reset after the measured RH goes below the value in this register.</p> <p>The humidity used for the threshold is composed of 14-bits as follows:</p> <table border="1"> <tr> <th colspan="7">Register 0x0E</th> <th colspan="7">Register 0x0D</th> </tr> <tr> <td>0</td><td>0</td><td>0</td><td>0</td><td>0</td><td>1</td><td>0</td> <td>1</td><td>1</td><td>0</td><td>0</td><td>0</td><td>0</td><td>0</td><td>0</td><td>0</td> </tr> <tr> <td colspan="7">0's</td> <td colspan="7">Reset Threshold [13:8]</td> </tr> <tr> <td colspan="7"></td> <td colspan="7">Reset Threshold [7:0]</td> </tr> </table> <p>This 14-bit value is converted into a humidity threshold using the same conversion equation shown in section 4.4.3.</p>	Register 0x0E							Register 0x0D							0	0	0	0	0	1	0	1	1	0	0	0	0	0	0	0	0's							Reset Threshold [13:8]														Reset Threshold [7:0]						
Register 0x0E							Register 0x0D																																																						
0	0	0	0	0	1	0	1	1	0	0	0	0	0	0	0																																														
0's							Reset Threshold [13:8]																																																						
							Reset Threshold [7:0]																																																						
Trigger Threshold for Relative Humidity Low Alert	0x12, 0x11	<13:0>	<p>Registers 0x12, 0x11 set the threshold for when the “RH Low” alert is triggered. When the measured RH goes below the value in this register, the Alert pin will be triggered.</p> <p>The humidity used for the threshold is composed of 14-bits as follows:</p> <table border="1"> <tr> <th colspan="7">Register 0x12</th> <th colspan="7">Register 0x11</th> </tr> <tr> <td>0</td><td>0</td><td>0</td><td>0</td><td>0</td><td>1</td><td>0</td> <td>1</td><td>1</td><td>0</td><td>0</td><td>0</td><td>0</td><td>0</td><td>0</td><td>0</td> </tr> <tr> <td colspan="7">0's</td> <td colspan="7">Trigger Threshold [13:8]</td> </tr> <tr> <td colspan="7"></td> <td colspan="7">Trigger Threshold [7:0]</td> </tr> </table> <p>This 14-bit value is converted into a humidity threshold using the same conversion equation shown in section 4.4.3.</p>	Register 0x12							Register 0x11							0	0	0	0	0	1	0	1	1	0	0	0	0	0	0	0	0's							Trigger Threshold [13:8]														Trigger Threshold [7:0]						
Register 0x12							Register 0x11																																																						
0	0	0	0	0	1	0	1	1	0	0	0	0	0	0	0																																														
0's							Trigger Threshold [13:8]																																																						
							Trigger Threshold [7:0]																																																						
Reset Threshold for Relative Humidity Low Alert	0x14, 0x13	<13:0>	<p>Registers 0x14, 0x13 sets the threshold for when the “RH Low” alert condition is reset. After the alert is triggered, it will only be reset after the measured RH goes above the value in this register.</p> <p>The humidity used for the threshold is composed of 14-bits as follows:</p> <table border="1"> <tr> <th colspan="7">Register 0x14</th> <th colspan="7">Register 0x13</th> </tr> <tr> <td>0</td><td>0</td><td>0</td><td>0</td><td>0</td><td>1</td><td>0</td> <td>1</td><td>1</td><td>0</td><td>0</td><td>0</td><td>0</td><td>0</td><td>0</td><td>0</td> </tr> <tr> <td colspan="7">0's</td> <td colspan="7">Reset Threshold [13:8]</td> </tr> <tr> <td colspan="7"></td> <td colspan="7">Reset Threshold [7:0]</td> </tr> </table> <p>This 14-bit value is converted into a humidity threshold using the same conversion equation shown in section 4.4.3.</p>	Register 0x14							Register 0x13							0	0	0	0	0	1	0	1	1	0	0	0	0	0	0	0	0's							Reset Threshold [13:8]														Reset Threshold [7:0]						
Register 0x14							Register 0x13																																																						
0	0	0	0	0	1	0	1	1	0	0	0	0	0	0	0																																														
0's							Reset Threshold [13:8]																																																						
							Reset Threshold [7:0]																																																						

### 4.9 Reading the Sensor ID Number

The sensor ID is a 32-bit number that can be used to identify a given device. Each sensor has a unique ID that can be used for traceability. The sequence to read the sensor ID is as follows:

1. Wake up the HS401x series sensor from sleep mode by sending its I<sup>2</sup>C address with a write bit, and initiate a Read Sensor ID command by sending the command 0xD7.
2. Change the direction of communication by sending the HS401x I<sup>2</sup>C address and a read bit. The SCL line is held low by the sensor while it retrieves the ID from internal memory to prevent data corruption. The sensor takes approximately 10µs to retrieve the ID from internal memory.
3. Once the request is completed by the HS401x series sensor, the SCL line is released and the chip waits for the SCL clock signal to send the results. The sensor will then transmit the 4-byte sensor ID on the bus for the master to capture, MSB first.

The command sequence to read the sensor ID is illustrated in Figure 22.

Step 1 :

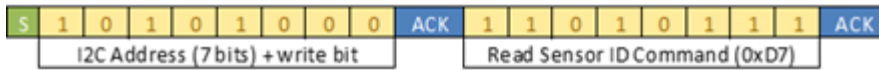

Step 2 :

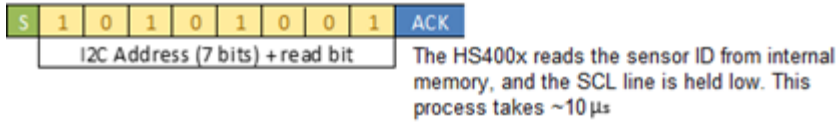

Step 3 :

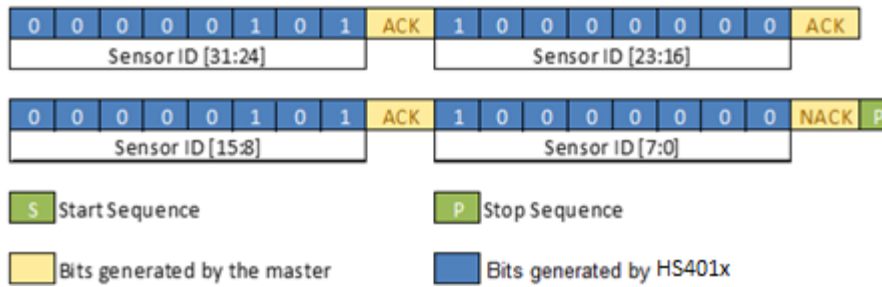

Figure 22. Read Sensor ID Command Sequence

## 5. Application Circuit

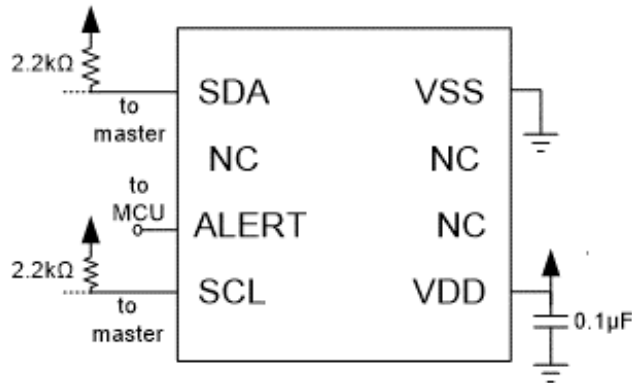

Figure 23. HS401x Application Circuit (Top View)

## 6. Soldering Information

This section discusses soldering considerations for the HS401x.

Standard reflow ovens can be used to solder the HS401x series sensor to the PCB. The peak temperature ( $T_p$ ) for use with the JEDEC J-STD-020D standard soldering profile is 260°C. For manual soldering, the contact time must be limited to 5 seconds at up to 350°C. In either case, if solder paste is used, it is recommended to use 'no-clean' solder paste to avoid the need to wash the PCB.

When a relative humidity sensor is exposed to the high heat associated with the soldering process, the sensor element tends to dry out. To avoid an offset in the relative humidity readings, the sensor element must be rehydrated after the soldering process. Care must also be taken when selecting the temperatures and durations involved in the soldering process to avoid irreversibly damaging the sensor element.

The recommended soldering profile for a lead-free (RoHS-compliant) process is shown below.

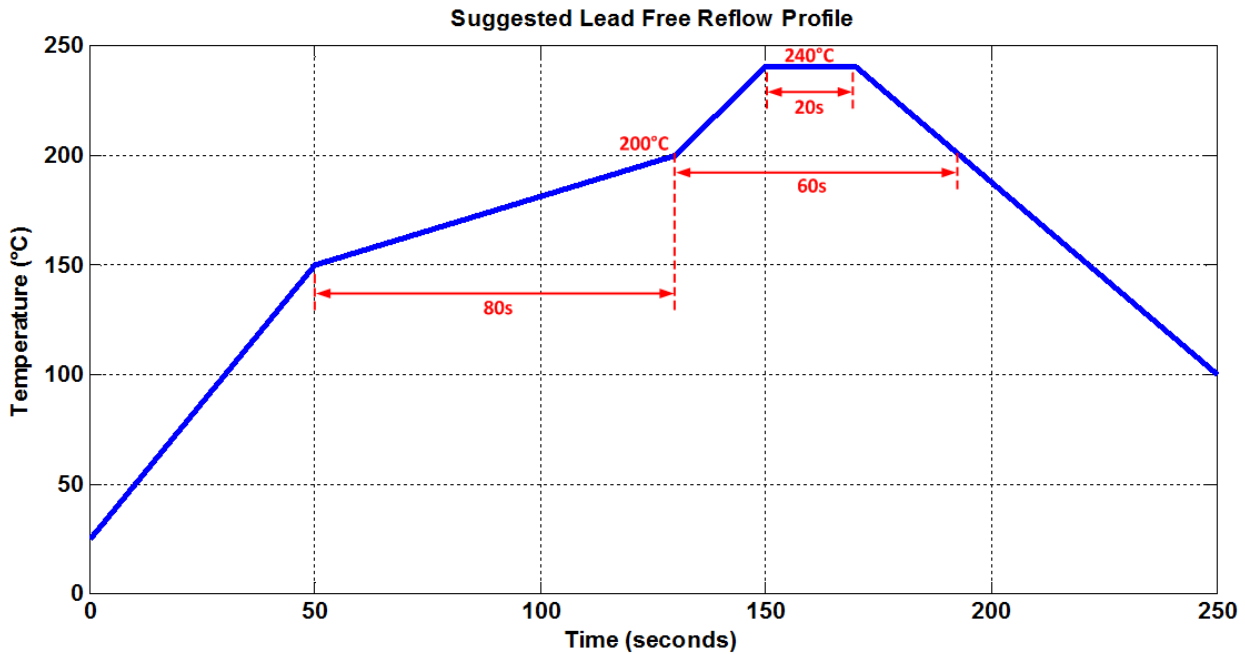

Figure 24. Recommended Soldering Profile

It is important to ensure this temperature profile is measured at the sensor itself. Measuring the profile at a larger component with a higher thermal mass means the temperature at the small sensor will be higher than expected.

For manual soldering, the contact time must be limited to **5 seconds** with a maximum iron temperature of **350°C**.

In either case, a board wash after soldering is **not** recommended. Therefore, if a solder paste is used, it is strongly recommended that a “**no-clean**” solder paste is used to avoid the need to wash the PCB.

After soldering, the recommended rehydration process should be done. Otherwise, there may be an initial offset in the relative humidity readings, which will slowly disappear as the sensor get exposed to ambient conditions.

Recommended rehydration process:

- A relative humidity of 75% RH at room temperature for at least 12 hours.
- or**
- A relative humidity of 40% to 50% RH at room temperature for 3 to 5 days.

## 7. PCB Layout Guide

When designing the PCB, undesired heat transfer paths to the HS401x series must be minimized. Excessive heat from other components on the PCB will result in inaccurate temperature and relative humidity measurements. As such, **solid metal planes for power supplies should be avoided in the vicinity of the sensor** since these will act as thermal conductors. To further reduce the heat transfer from other components on the board, openings can be milled into the PCB as shown in Figure 25.

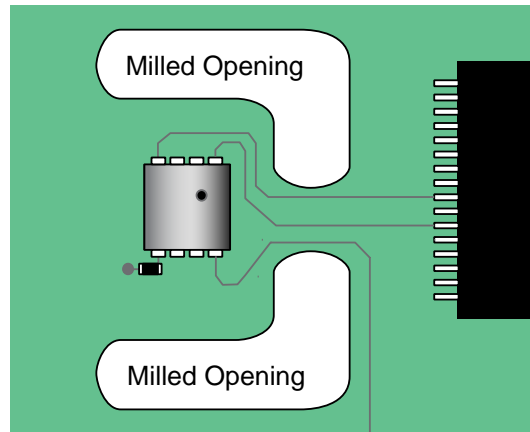

Figure 25. Milled PCB Openings for Thermal Isolation

## 8. Storage and Handling

Recommendation: Once the sensors are removed from their original packaging, store them in metal-in antistatic bags.

Avoid using polyethylene antistatic bags as they may affect sensor accuracy.

The nominal storage conditions are 10 to 50°C and humidity levels within 20% to 60% RH. If stored outside of these conditions for extended periods of time, the sensor readings may exhibit an offset. The sensor can be reconditioned and brought back to its calibration state by applying the following procedure:

1. Bake at a temperature of 100°C with a humidity < 10% RH for 10 to 12 hours.
2. Rehydrate the sensor at a humidity of 75% RH and a temperature between 20 to 30°C for 12 to 14 hours.

## 9. Quality and Reliability

The HS401x series is available as a qualified product for consumer and industrial market applications. All data specified parameters are guaranteed if not stated otherwise.

## 10. Package Outline Drawings

The package outline drawings are located at the end of this document and are accessible from the Renesas website. The package information is the most current data available and is subject to change without revision of this document.

## 11. Ordering Information

Part Number	Package Description	Carrier Type	Temperature Range
HS4011	Digital Relative Humidity and Temperature Sensor, with Membrane. ±1.5%RH (Typical), 2.5 × 2.5 × 0.9mm, <a href="#">8-LGA</a>	Reel	-40°C to +125°C
HS4012	Digital Relative Humidity and Temperature Sensor, with Membrane. ±1.8%RH (Typical), 2.5 × 2.5 × 0.9mm, <a href="#">8-LGA</a>	Reel	-40°C to +125°C
HS4013	Digital Relative Humidity and Temperature Sensor, with Membrane. ±2.5%RH (Typical), 2.5 × 2.5 × 0.9mm, <a href="#">8-LGA</a>	Reel	-40°C to +125°C
HS4014	Digital Relative Humidity and Temperature Sensor, with Membrane. ±3.5%RH (Typical), 2.5 × 2.5 × 0.9mm, <a href="#">8-LGA</a>	Reel	-40°C to +125°C

## 12. Revision History

Revision	Date	Description
1.02	Apr 27, 2022	<ul style="list-style-type: none"> <li>▪ Added AEC-Q100 qualified, -40°C to +105C</li> <li>▪ Added Industrial JEDEC qualified, -40°C to +125C</li> <li>▪ Completed other minor changes</li> </ul>
1.01	Apr 14, 2022	<ul style="list-style-type: none"> <li>▪ Added Table 11. Alert Feature Settings.</li> <li>▪ Added AEC-Q100 qualified.</li> </ul>
1.00	Feb 2, 2022	Initial release.



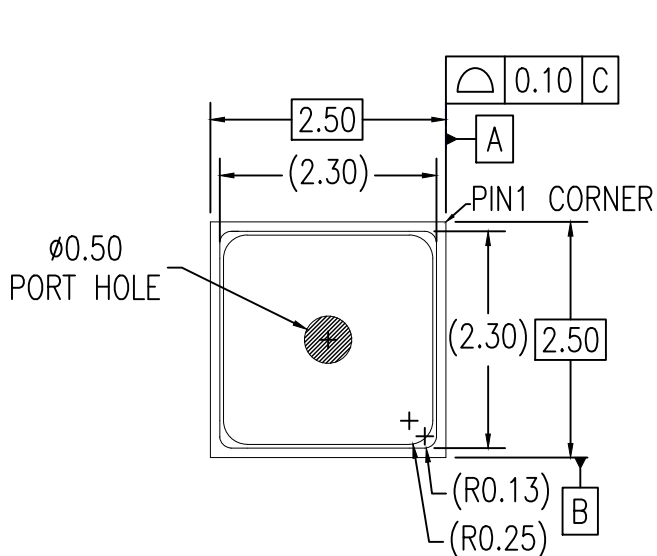

TOP VIEW

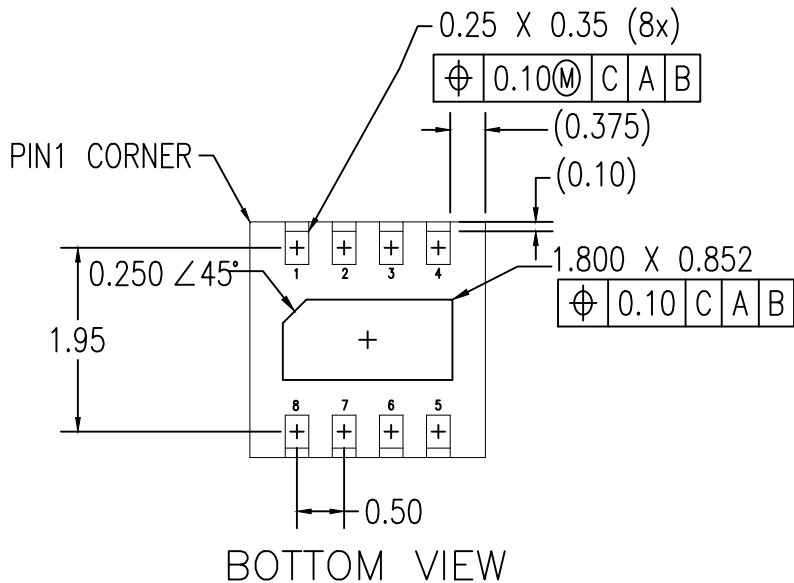

BOTTOM VIEW

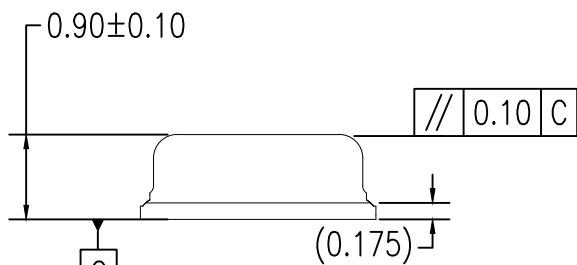

SIDE VIEW

NOTES:

DIMENSIONS AND TOLERANCES IN MM.

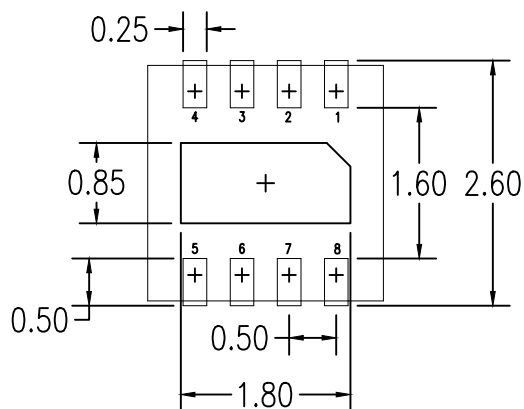

#### RECOMMENDED LAND PATTERN DIMENSION

#### NOTES:

1. ALL DIMENSION ARE IN MM. ANGLES IN DEGREES.
2. LAND PATTERN RECOMMENDATION PER IPC-7351B  
GENERIC REQUIREMENT FOR SURFACE MOUNT DESIGN  
AND LAND PATTERN.

Package Revision History		
Date Created	Rev No.	Description
Sep t 6, 2020	00	Initial Release

## IMPORTANT NOTICE AND DISCLAIMER

RENESAS ELECTRONICS CORPORATION AND ITS SUBSIDIARIES (“RENESAS”) PROVIDES TECHNICAL SPECIFICATIONS AND RELIABILITY DATA (INCLUDING DATASHEETS), DESIGN RESOURCES (INCLUDING REFERENCE DESIGNS), APPLICATION OR OTHER DESIGN ADVICE, WEB TOOLS, SAFETY INFORMATION, AND OTHER RESOURCES “AS IS” AND WITH ALL FAULTS, AND DISCLAIMS ALL WARRANTIES, EXPRESS OR IMPLIED, INCLUDING, WITHOUT LIMITATION, ANY IMPLIED WARRANTIES OF MERCHANTABILITY, FITNESS FOR A PARTICULAR PURPOSE, OR NON-INFRINGEMENT OF THIRD PARTY INTELLECTUAL PROPERTY RIGHTS.

These resources are intended for developers skilled in the art designing with Renesas products. You are solely responsible for (1) selecting the appropriate products for your application, (2) designing, validating, and testing your application, and (3) ensuring your application meets applicable standards, and any other safety, security, or other requirements. These resources are subject to change without notice. Renesas grants you permission to use these resources only for development of an application that uses Renesas products. Other reproduction or use of these resources is strictly prohibited. No license is granted to any other Renesas intellectual property or to any third party intellectual property. Renesas disclaims responsibility for, and you will fully indemnify Renesas and its representatives against, any claims, damages, costs, losses, or liabilities arising out of your use of these resources. Renesas' products are provided only subject to Renesas' Terms and Conditions of Sale or other applicable terms agreed to in writing. No use of any Renesas resources expands or otherwise alters any applicable warranties or warranty disclaimers for these products.

(Rev.1.0 Mar 2020)

### Corporate Headquarters

TOYOSU FORESIA, 3-2-24 Toyosu,  
Koto-ku, Tokyo 135-0061, Japan  
[www.renesas.com](http://www.renesas.com)

### Contact Information

For further information on a product, technology, the most up-to-date version of a document, or your nearest sales office, please visit:  
[www.renesas.com/contact/](http://www.renesas.com/contact/)

### Trademarks

Renesas and the Renesas logo are trademarks of Renesas Electronics Corporation. All trademarks and registered trademarks are the property of their respective owners.