

Low Profile Shielded SMD Chip Power Inductor

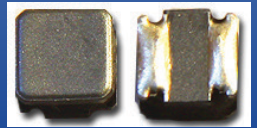

ASPI-0315FS



3.0 x 3.0 x 1.5mm
RoHS/RoHS Compliant

Features

- Small size and low profile: 1.5mm
- Small DCR and high rated current
- High reliability to mechanical stress
- Magnetically shielded by magnetic powder molding
- Suitable for RoHS reflow profile

Applications

- Mobile phones
- MP3 & 4 and other portable communication equipment
- Digital cameras

Electrical Specifications

Operating Temperature & Humidity:	-25°C to +120°C (Including self generated heat)
Storage Temperature & Humidity:	-10°C to +40°C, 30% to 70% RH

Part Number ASPI-0315FS Inductance Code	Inductance	Inductance Tolerance	DC Resistance		Saturation Current	Temperature Rise Current	Self-Resonant Frequency
			Max	Typ			
Units	μH	%	mΩ	mΩ	A	A	MHz
Symbol	L	M, N	DCR		Isat	Irms	SRF
ASPI-0315FS-R50	0.5	N	39	30	3.90	2.60	162
ASPI-0315FS-1R0	1.0	N	39	30	2.32	2.35	150
ASPI-0315FS-1R2	1.2	N	52	40	2.21	1.95	110
ASPI-0315FS-1R5	1.5	N	65	50	2.3	1.70	100
ASPI-0315FS-1R8	1.8	N	65	50	1.75	1.70	92
ASPI-0315FS-2R2	2.2	N	78	60	1.60	1.60	86
ASPI-0315FS-2R7	2.7	N	98	75	1.52	1.43	64
ASPI-0315FS-3R3	3.3	M	104	80	1.32	1.36	68
ASPI-0315FS-3R6	3.6	M	137	105	1.28	1.20	59
ASPI-0315FS-3R9	3.9	M	137	105	1.20	1.20	47
ASPI-0315FS-4R3	4.3	M	150	115	1.20	1.14	53
ASPI-0315FS-4R7	4.7	M	163	125	1.10	1.09	46
ASPI-0315FS-5R1	5.1	M	173	133	1.00	1.05	49
ASPI-0315FS-6R2	6.2	M	254	195	1.00	0.86	46
ASPI-0315FS-6R8	6.8	M	260	200	0.85	0.85	39
ASPI-0315FS-100	10	M	325	250	0.72	0.77	41
ASPI-0315FS-120	12	M	416	320	0.70	0.68	32
ASPI-0315FS-150	15	M	455	350	0.66	0.65	30
ASPI-0315FS-180	18	M	559	430	0.56	0.59	23



5101 Hidden Creek Ln Spicewood TX 78669
Phone: 512-371-6159 | Fax: 512-351-8858
For terms and conditions of sales, please visit:
www.abracon.com

REVISED: 09-22-20

ABRACON IS
ISO9001-2015
CERTIFIED

Low Profile Shielded SMD Chip Power Inductor



ASPI-0315FS



3.0 x 3.0 x 1.5mm
RoHS/RoHS Compliant

Electrical Specifications cont.

Part Number ASPI-0315FS Inductance Code	Inductance	Inductance Tolerance	DC Resistance		Saturation Current	Temperature Rise Current	Self-Resonant Frequency
			Max	Typ			
Units	μH	%	$\text{m}\Omega$	$\text{m}\Omega$	A	A	MHz
Symbol	L	M, N	DCR		Isat	Irms	SRF
ASPI-0315FS-220	22	M	598	460	0.52	0.57	23
ASPI-0315FS-270	27	M	949	730	0.48	0.45	22
ASPI-0315FS-330	33	M	1066	820	0.44	0.43	20
ASPI-0315FS-390	39	M	1294	995	0.41	0.39	14
ASPI-0315FS-430	43	M	1378	1060	0.37	0.37	16
ASPI-0315FS-470	47	M	1625	1250	0.35	0.35	14
ASPI-0315FS-560	56	M	1664	1280	0.33	0.34	13
ASPI-0315FS-620	62	M	2093	1610	0.30	0.30	13
ASPI-0315FS-680	68	M	3510	2700	0.28	0.23	11
ASPI-0315FS-101	100	M	4043	3110	0.23	0.21	7.2
ASPI-0315FS-151	150	M	4940	3800	0.18	0.19	4.5

Test Conditions

1. Inductance is measured using a WK3260B LCR meter or equivalent.
2. DCR is measured using HIOKI 3540 or equivalent.
3. Isat : Based on inductance change ($\Delta L/L_o : \leq -30\%$)
4. Irms : Based on temperature rise ($\Delta T : 40^\circ\text{C TYP.}$)
5. SRF: Agilent E4991A+16197 or equivalent.
6. Test Freq: 100KHz, 1Vrms

Part Number Identification

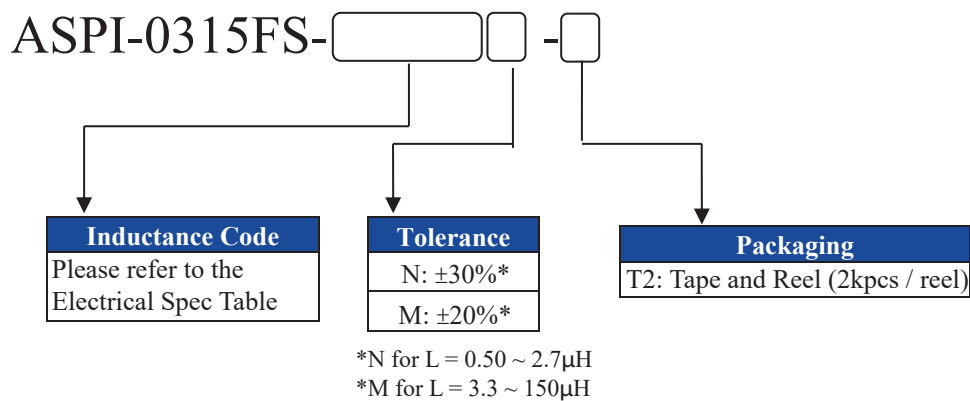

Low Profile Shielded SMD Chip Power Inductor



ASPI-0315FS



3.0 x 3.0 x 1.5mm
RoHS/RoHS Compliant

Mechanical Information

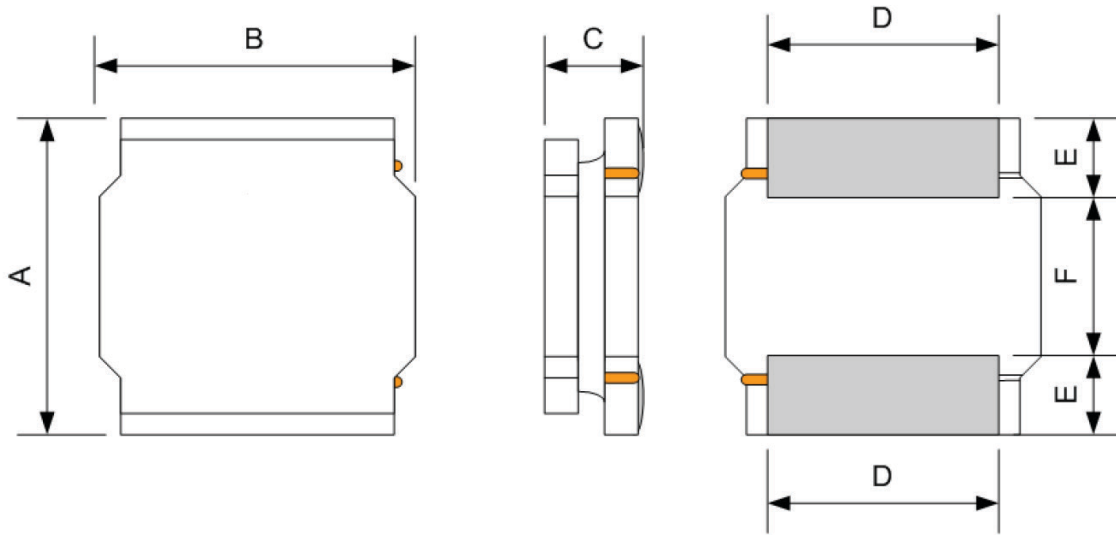

A	B	C	D	E	F	a Typ.	b Typ.	C Typ.
3.0 ± 0.2	3.0 ± 0.2	1.5 Max	2.50 ± 0.2	0.75 ± 0.2	1.5 ± 0.2	1.5	0.8	2.7

Circuit Schematic

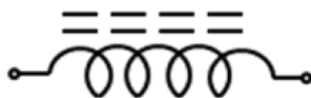

No Polarity

Recommended Land Pattern

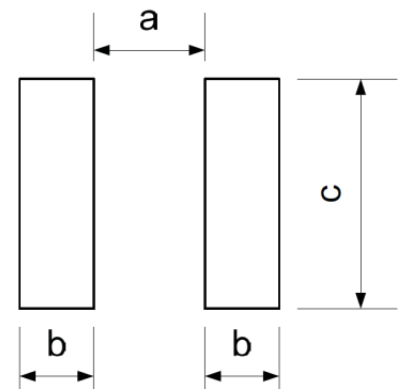

Dimensions: mm



5101 Hidden Creek Ln Spicewood TX 78669
Phone: 512-371-6159 | Fax: 512-351-8858
For terms and conditions of sales, please visit:
www.abracon.com

REVISED: 09-22-20

ABRACON IS
ISO9001-2015
CERTIFIED

Low Profile Shielded SMD Chip Power Inductor

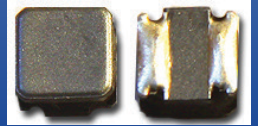

ASPI-0315FS



3.0 x 3.0 x 1.5mm
RoHS/RoHS Compliant

Reflow Profile

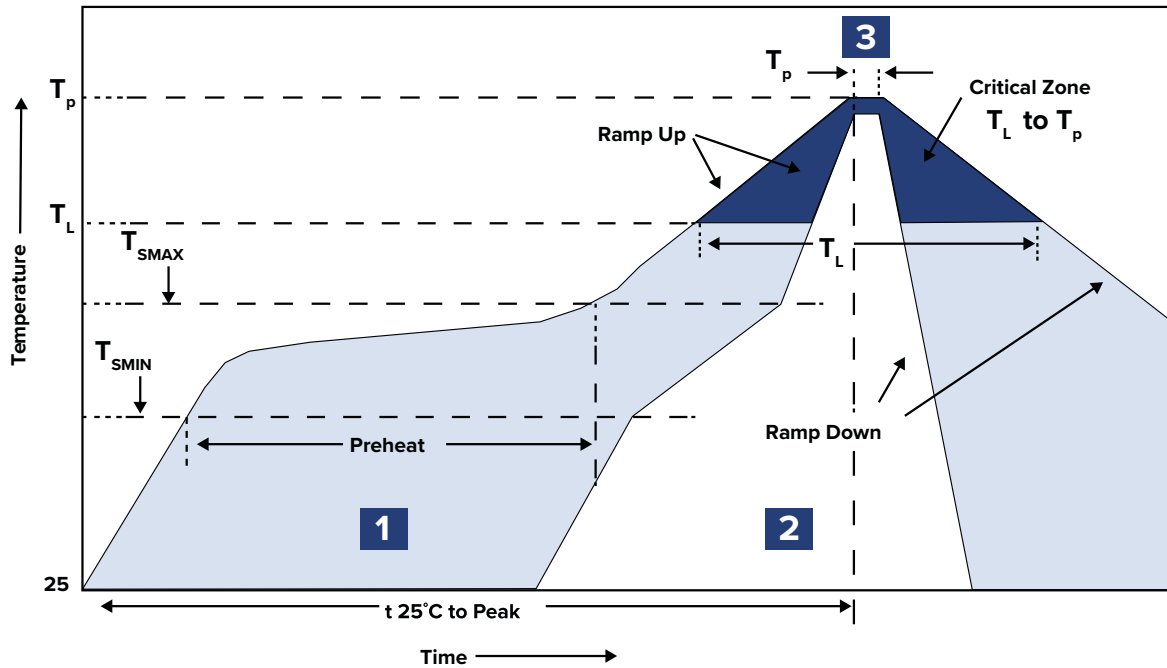

Zone	Description	Temperature	Time
1	Preheat / Soak	$T_{SMIN} \sim T_{SMAX}$ 150°C ~ 200°C	60 ~ 120 sec.
2	Reflow	T_L 217°C	60 ~ 90 sec.
3	Peak heat	T_P 260°C	10 sec. MAX

Low Profile Shielded SMD Chip Power Inductor



ASPI-0315FS



3.0 x 3.0 x 1.5mm
RoHS/RoHS Compliant

Packaging

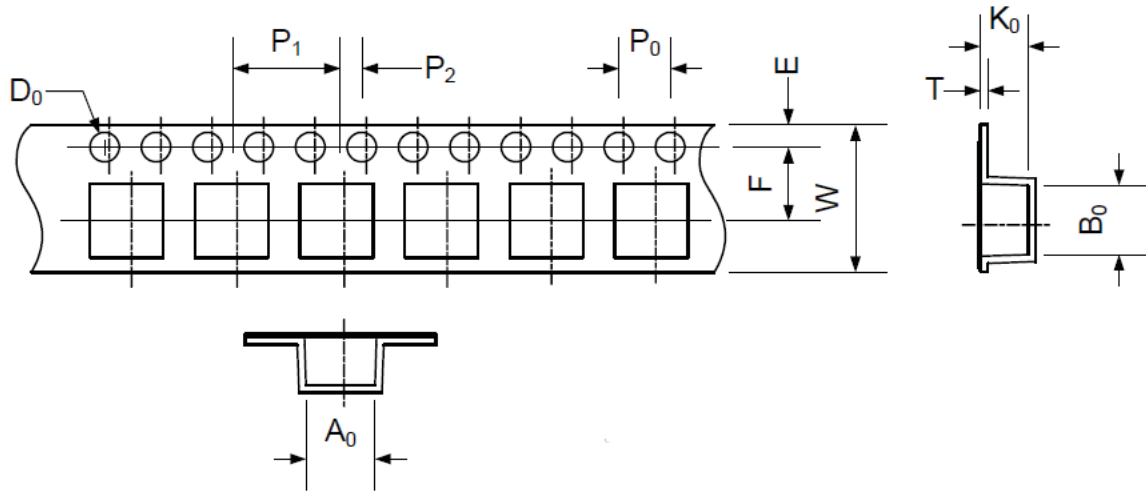

A ₀	B ₀	W	E	F	P ₀	P ₁	P ₂	D ₀	T	K ₀
3.3 ±0.1	3.3 ±0.1	8.0 ±0.3	1.75 ±0.1	3.5 ±0.05	4.0 ±0.1	4.0 ±0.1	2.0 ±0.1	1.5 +0.1/-0.0	0.25 ±0.03	1.6 ±0.1

Dimensions: mm

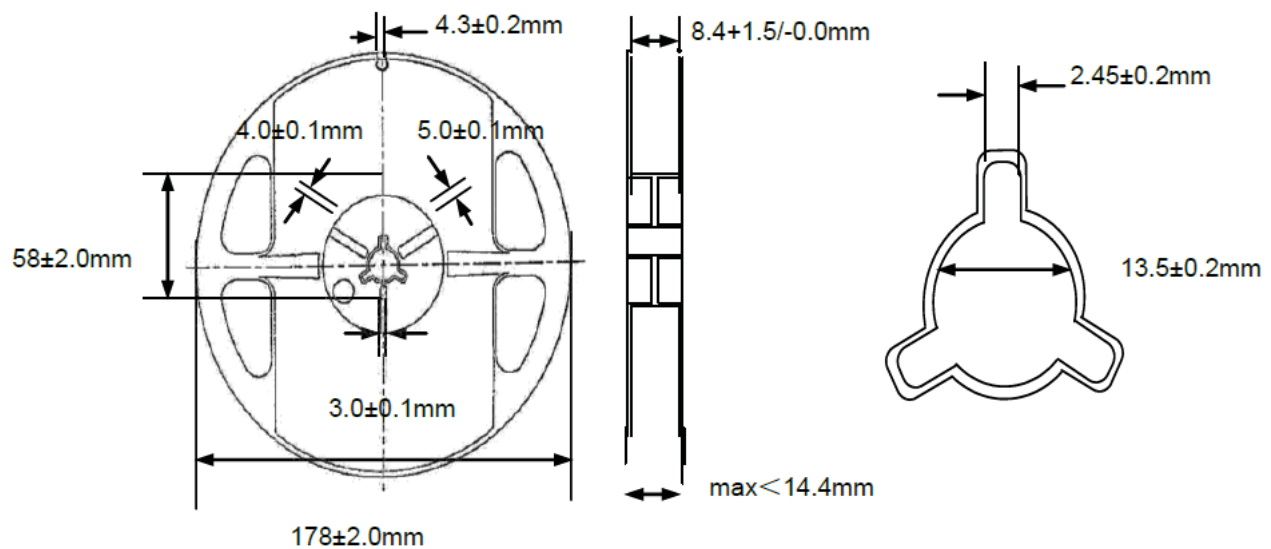

ATTENTION: Abracon LLC's products are COTS – Commercial-Off-The-Shelf products; suitable for Commercial, Industrial and, where designated, Automotive Applications. Abracon's products are not specifically designed for Military, Aviation, Aerospace, Life-dependent Medical applications or any application requiring high reliability where component failure could result in loss of life and/or property. For applications requiring high reliability and/or presenting an extreme operating environment, written consent and authorization from Abracon LLC is required. Please contact Abracon LLC for more information.



5101 Hidden Creek Ln Spicewood TX 78669
Phone: 512-371-6159 | Fax: 512-351-8858
For terms and conditions of sales, please visit:
www.abracon.com

REVISED: 09-22-20

ABRACON IS
ISO9001-2015
CERTIFIED