



深圳市晶科鑫实业有限公司

样品承认书

客户代码:	
物料名称:	贴片晶振
规格型号:	SMD 5032 20.000MHZ 20PF ±20PPM
P N/ SJK:	7120000F20UCG

承 认 签 章					
供 应 商 承 认			() 公 司 承 认		
制 定	审 核	核 准	工 程 师	审 核	批 准
林雁	杨霞	黄灏东			
盖章签署			盖章签署		
日 期			日 期		
批示: <input type="checkbox"/> 接受 <input type="checkbox"/> 有条件接受					
备注:					

公司地址: 深圳市龙岗区天安云谷产业园一期3栋C座12楼1204~1206室

电 话: 0755-88352810-837

传 真: 0755-88353718

QUARTZ CRYSTAL UNIT

SERIES 7I, SEAM SEALED CERAMIC 5.3*3.2MM SURFACE MOUNT PACKAGE



Approved by: 黄灏东

Checked by: 杨霞

Issued by: 玉静霞

产品规格书

SPECIFICATION

PN / SJK: 7I20000F20UCG

深圳市晶科鑫实业有限公司

SHENZHEN CRYSTAL TECHNOLOGY INDUSTRIAL CO., LTD.

公司地址: 深圳市龙岗区天安云谷产业园一期3栋C座12楼1204~1206室

电 话: 0755-88352810-837

传 真: 0755-88353718

QUARTZ CRYSTAL UNIT

SERIES 7I, SEAM SEALED CERAMIC 5.3*3.2MM SURFACE MOUNT PACKAGE



修改记录					
版次	修改日	项目	改定内容	改定者	确认者
A1	2015-6-5		初版	林雁	杨霞

目 录

序号	项 目	页次
1	产品特征	5
2	产品技术指标	5
3	产品规格尺寸	6
4	产品丝印说明	6
5	SJK 产品料号说明	6
6	产品内部结构及材料清单	7
7	焊接条件	8
8	晶振等效电路及应用电路	8
9	产品包装方式	9
10	产品可靠性试验	10-11
11	晶振工艺流程	11
12	有害物质含量声明	12
13	SGS 测试报告	附页

QUARTZ CRYSTAL UNIT

SERIES 7I, SEAM SEALED CERAMIC 5.3*3.2MM SURFACE MOUNT PACKAGE



1. FEATURE/产品特征

- Leadless type
- High precision characteristic covering up to high frequency range
- Designed for automatic mounting and reflow soldering
- Embossed taping specification
- The best choice of Bluetooth wireless communication sets, DSN, PDA and mobile phone

2. ELECTRICAL SPECIFICATIONS/产品技术指标

Output Frequency Range/中心频率	20.0000000MHz
Mode/振动模式	AT/Fundamental
Frequency Tolerance/频率稳定度(at 25°C)	±20ppm max
Load Capacitance(C _L)/ 负载电容	20.0 PF
Frequency Stability Over Operating Temperature Characteristics 温度频率稳定度	±30ppm max
Operating Temperature Range/工作温度	-40 °C to +85 °C
Storage Temperature Range/储存温度	-40 °C to +85 °C
Shunt Capacitance (C ₀)/静电容	3.0 PF Max
Driver Level (Typical) /激励功率	100μW
Equivalent Series Resistance(ESR)/等效电阻	40Ω Max
Aging @25°C 1 st year (Max) / 年老化	±3ppm/year

QUARTZ CRYSTAL UNIT



SERIES 71, SEAM SEALED CERAMIC 5.3*3.2MM SURFACE MOUNT PACKAGE

3. DIMENSION / 产品规格尺寸 (Units: mm)

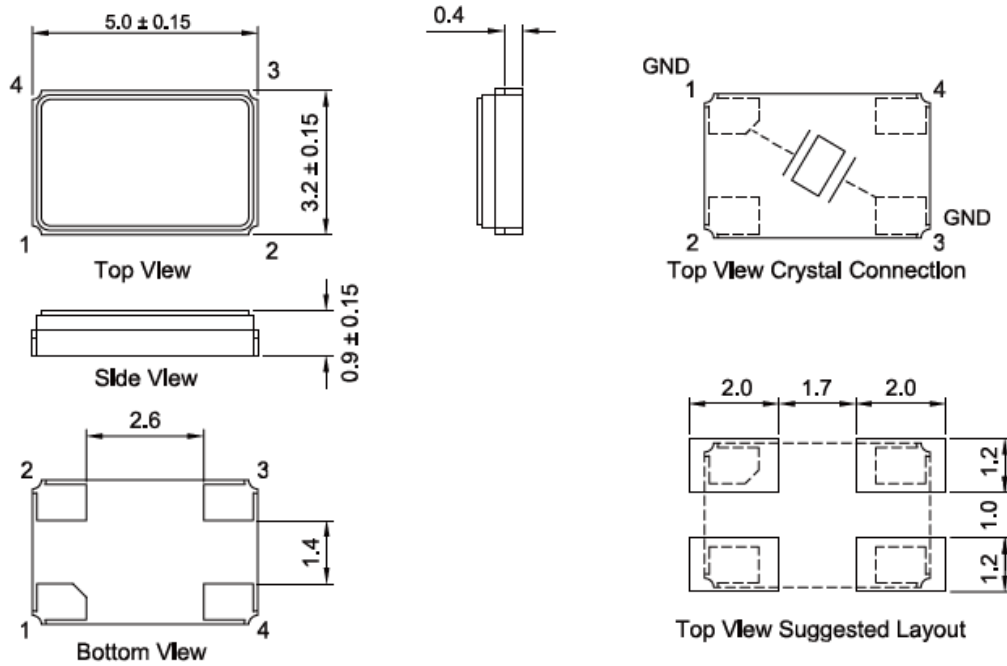

4. MARKING / 丝印

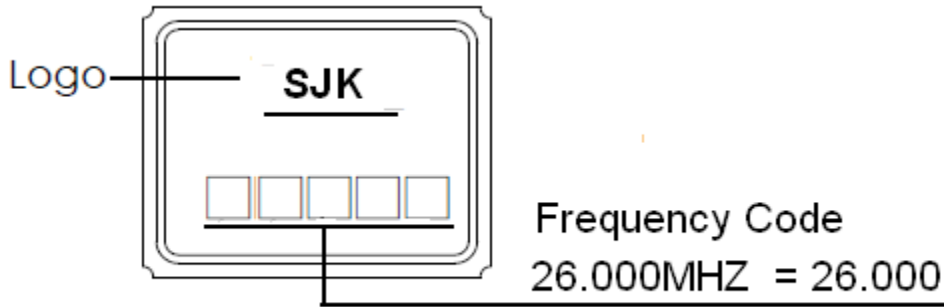

5. PART NUMBER / SJK 产品料号

SJK-71-20000	F	20	U	C	G
Frequency e.g. 20000: 20.000MHz	Frequency tolerance F: ± 20 ppm	Load capacitance 20:20.0PF	E.S.R.Max U:40 Ω max	Operating temperature range C:-40-85 $^{\circ}$ C	Temperature stability: e.g. G: ± 30 ppm

QUARTZ CRYSTAL UNIT

SERIES 7I, SEAM SEALED CERAMIC 5.3*3.2MM SURFACE MOUNT PACKAGE



6. STRUCTURE ILLUSTRATION/ 产品内部结构

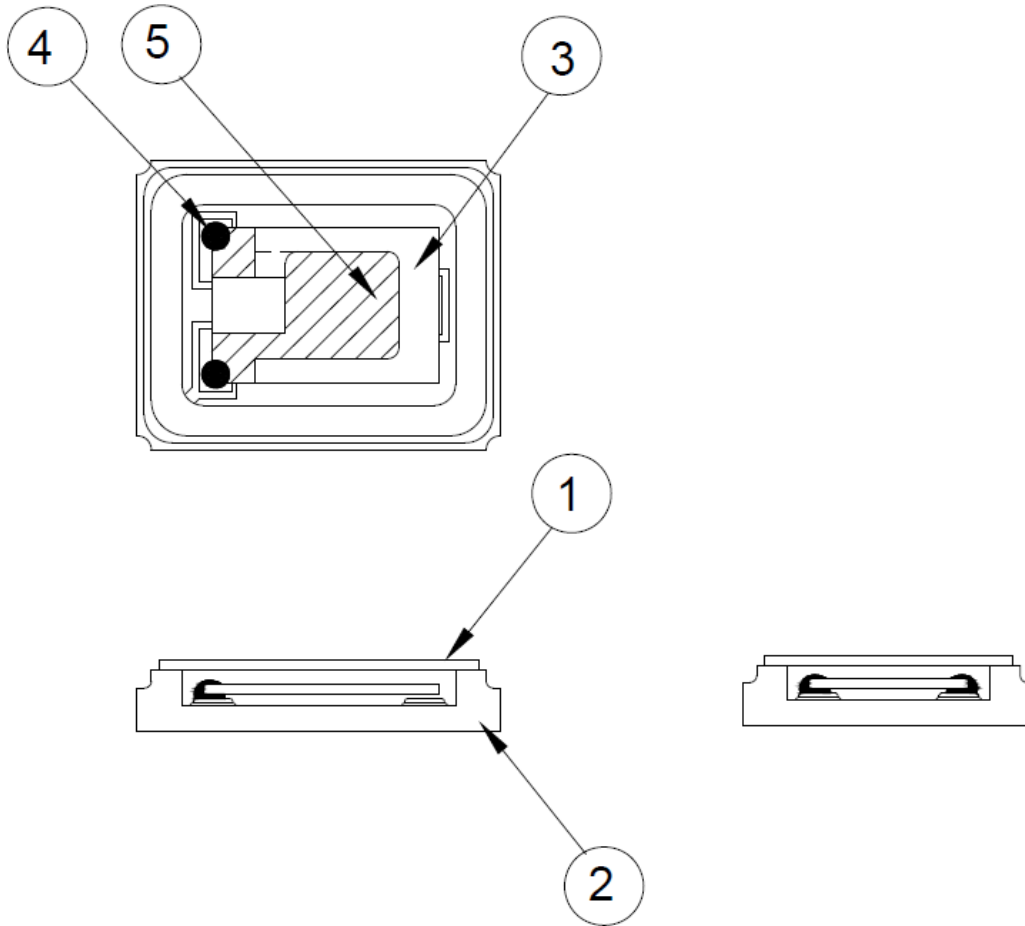

NO	COMPONENTS	MATERIALS	FINISH/SPECIFICATIONS
1	Lid	Kovar (Fe/Co/Ni)	-
2	Base(Package)	Ceramic (Al ₂ O ₃) + Kovar (Fe/Co/Ni)+Pad(Au)	Alumina ceramics
3	Crystal blank	SiO ₂	-
4	Conductive adhesive	Ag	Silicone resin
5	Electrode	Noble Metal	-

QUARTZ CRYSTAL UNIT



SERIES 71, SEAM SEALED CERAMIC 5.3*3.2MM SURFACE MOUNT PACKAGE

7. REFLOW CONDITION / 回流焊

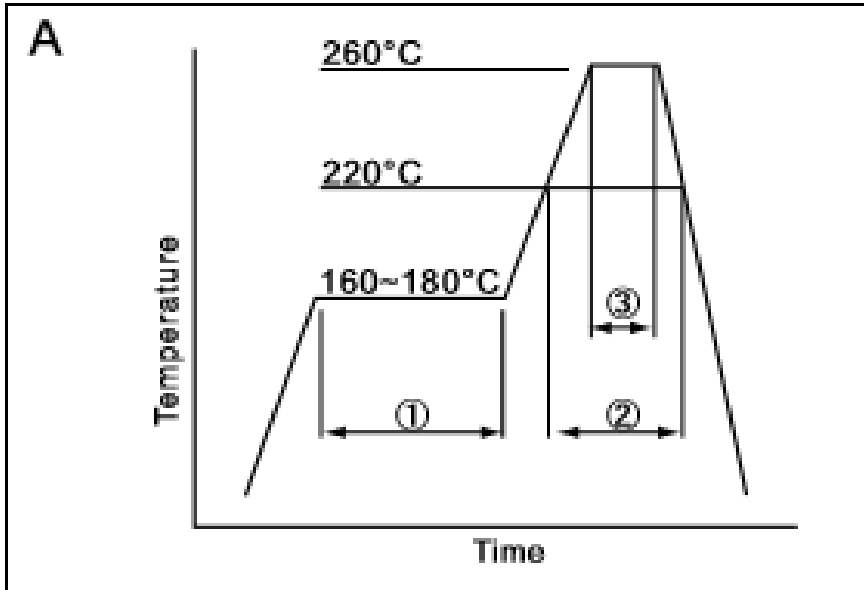

①	Preheat	160~180°C	120sec.
②	Primary heat	220°C	60sec.
③	Peak	260°C	10sec. max

8. EQUIVALENT CIRCUIT AND OSCILLATION CIRCUIT

等效电路

应用电路

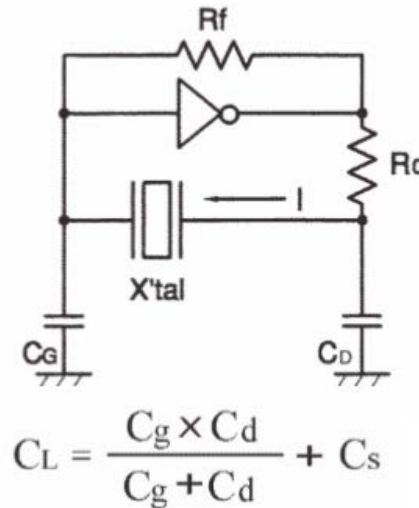
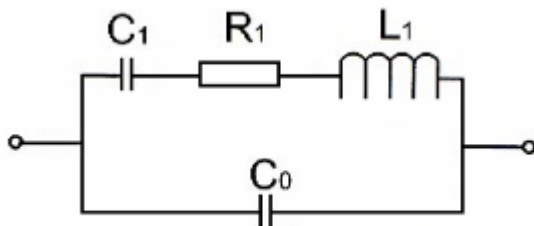

QUARTZ CRYSTAL UNIT



SERIES 7I, SEAM SEALED CERAMIC 5.3*3.2MM SURFACE MOUNT PACKAGE

9. PACKING /包装

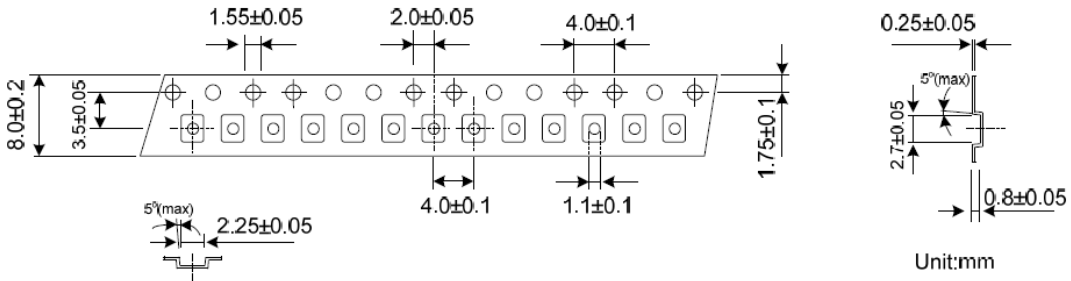

REMARK :

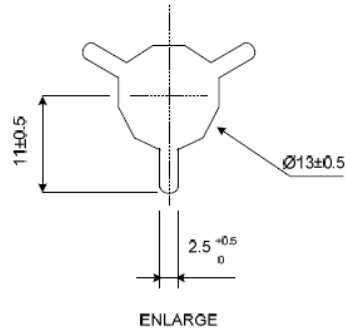
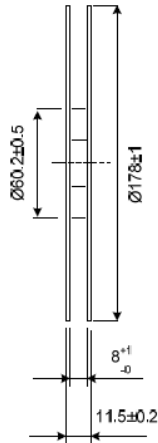
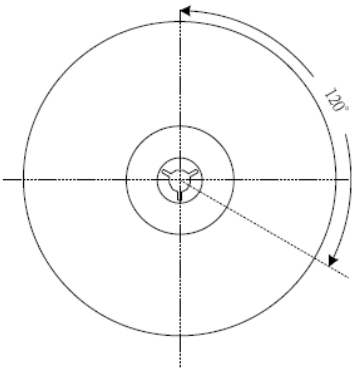
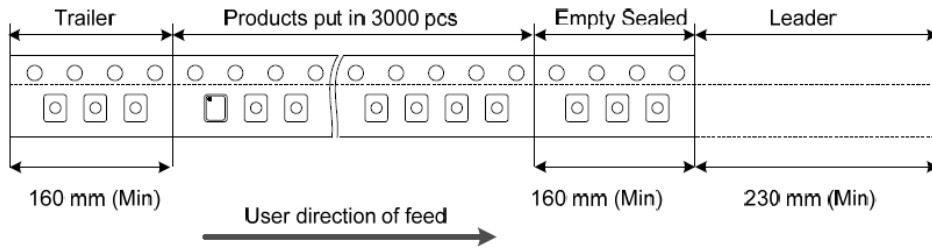

QUARTZ CRYSTAL UNIT

SERIES 71, SEAM SEALED CERAMIC 5.3*3.2MM SURFACE MOUNT PACKAGE

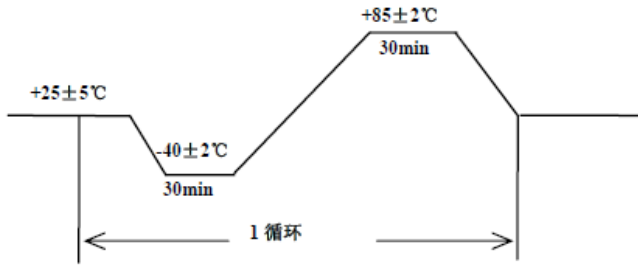
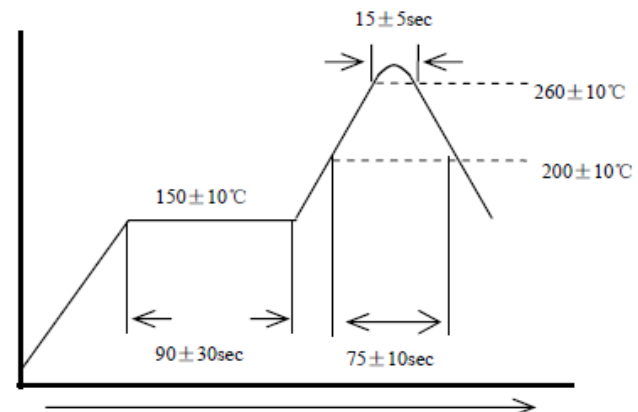

10. RELIABILITY TEST SPECIFICATION /可靠性试验

序号	试验项目	试验条件	标准要求
1	跌落□	从 75cm 位置高度, 自由跌落在木板上, 连续 3 次	试验前后, 频率变化不超过 $\pm 5\text{ppm}$, 电阻变化不超过 $\pm 15\%$
2	振动□	振动频率: $10\sim 55\text{Hz}$ □ 全振幅: 1.5mm □ 时间: 每个方位三面 (X、Y、Z) 各振动 2 小时	试验前后, 频率变化不超过 $\pm 5\text{ppm}$, 电阻变化不超过 $\pm 15\%$
3	冷热冲击□	晶体放入试验箱中, 高低温循环25次□ 低温为 $-40\pm 3^\circ\text{C}$ 保持30分钟, 高温 $85\pm 2^\circ\text{C}$ 保持保持30分钟, 高、低温每3分钟变换一次□ 	试验前后, 频率变化不超过 $\pm 5\text{ppm}$, 电阻变化不超过 $\pm 15\%$
4	气密性□	氦气气压标准: $5\pm 0.5\text{Kg/cm}^2$, 氦气加压时间: 120□分钟□	漏率标准: $\leq 1 \times 10^{-9}\text{Pa} \cdot \text{m}^3/\text{s}$ □
5	耐焊接热□	波峰温度: $260^\circ\text{C} \pm 10^\circ\text{C}$ □□□□时间: 15 ± 5 □秒 	试验前后, 频率变化不超过 $\pm 5\text{ppm}$, 电阻变化不超过 $\pm 15\%$ □

QUARTZ CRYSTAL UNIT



SERIES 7I, SEAM SEALED CERAMIC 5.3*3.2MM SURFACE MOUNT PACKAGE

6	沾锡试验	温度：260° ± 0° 浸泡时间：3 ± 1 秒	引脚沾锡后覆盖面积达90%以上
7	高温高湿	温度：60° ± 2° 湿度：90%~95% 保持时间：240 个小时	1. 试验前后, 频率变化不超过 ±5ppm, 电阻变化不超过 ±15% 2. 制品表面不可生锈
8	高温试验	高温温度：85° ± 2° 时间：240 个小时	试验前后, 频率变化不超过 ±5ppm, 电阻变化不超过 ±15%
9	低温试验	高温温度：-40° ± 2° 时间：240 个小时	试验前后, 频率变化不超过 ±5ppm, 电阻变化不超过 ±15%
10	盐雾	盐雾浓度：5% 温度：25°C 时间：36 小时	制品表面不可生锈
11	寿命测试	电压 5V 温度：25°C 时间：1000 小时	试验前后, 频率变化不超过 ±5ppm, 电阻 15%

11. PROCESS FLOW CHART / 工艺流程

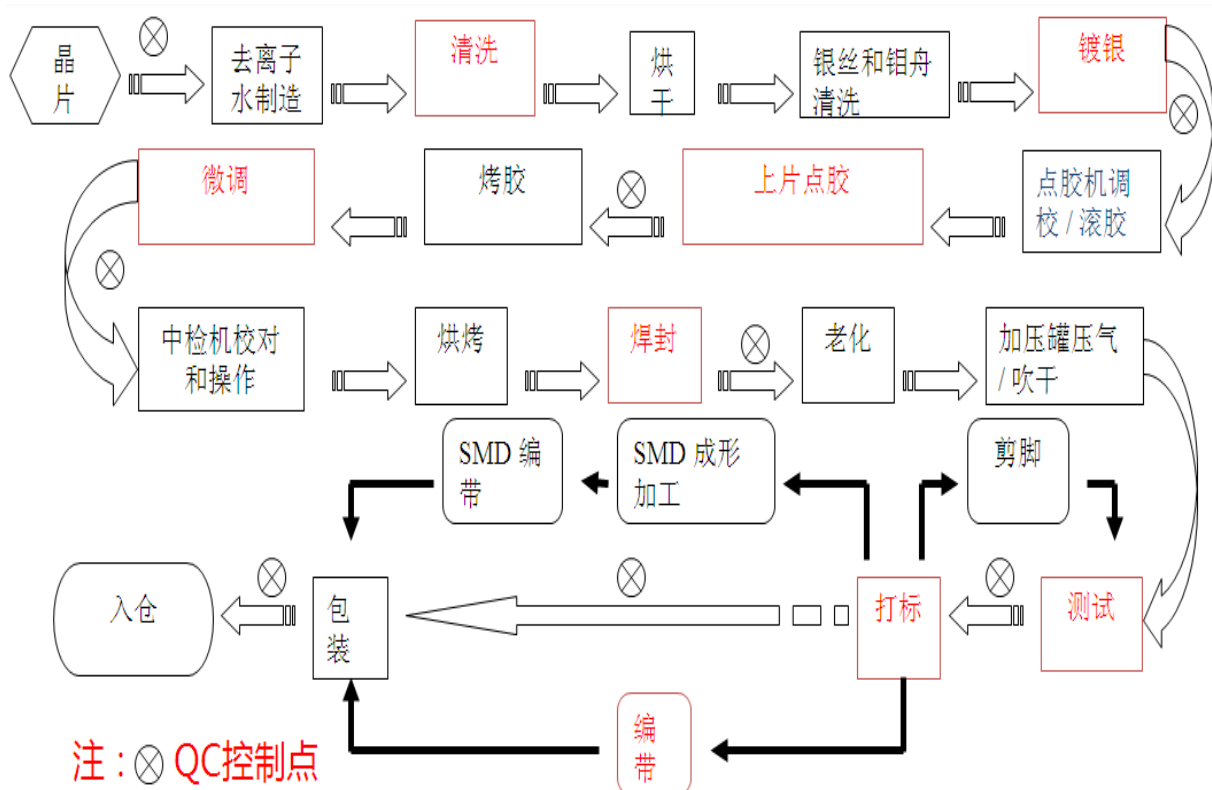

QUARTZ CRYSTAL UNIT

SERIES 7I, SEAM SEALED CERAMIC 5.3*3.2MM SURFACE MOUNT PACKAGE



12 STATEMENT OF HAZARDOUS MATERIAL CONTENT

有害物质含量声明

SMD SEAM 7050/5032/6035/3225/2520/2016/1612 系列

有毒有害物质或元素的名称及含量表							
材料名称 □	有毒有害物质或元素						
	铅 (Pb)	汞 (Hg) □	镉 (Cd)	六价铬□ (Cr (VI))	多溴联苯 □ (PBB)	多溴二苯醚□ (PBDE)	备注
晶片□	ND	ND	ND	ND	ND	ND	
基座□	ND	ND	ND	ND	ND	ND	
上盖□	ND	ND	ND	ND	ND	ND	
银层□	ND	ND	ND	ND	ND	ND	
导电胶□	ND	ND	ND	ND	ND	ND	
~~~~~							

详 SGS 测试报告