



## S2AF THRU S2MF Surface Mount Standard Rectifiers

**Reverse Voltage - 50 to 1000 V**

**Forward Current - 2 A**

### FEATURES

- For surface mounted applications
- Low profile package
- Glass Passivated Chip Junction
- Easy to pick and place
- Lead free in comply with EU RoHS 2011/65/EU directives

### MECHANICAL DATA

- Case: SMAF
- Terminals: Solderable per MIL-STD-750, Method 2026
- Approx. Weight: 27mg 0.00086oz

### PINNING

| PIN | DESCRIPTION |
|-----|-------------|
| 1   | Cathode     |
| 2   | Anode       |

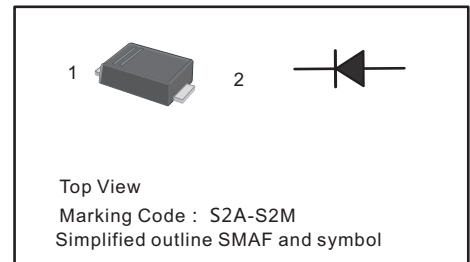

### Maximum Ratings and Electrical characteristics

Ratings at 25 °C ambient temperature unless otherwise specified.

Single phase half-wave 60 Hz, resistive or inductive load, for capacitive load current derate by 20 %.

| Parameter   | Symbols                            | S2AF       | S2BF | S2DF | S2GF | S2JF | S2KF | S2MF | Units              |
|---|------------------------------------|------------|------|------|------|------|------|------|--------------------|
| Maximum Repetitive Peak Reverse Voltage   | $V_{RRM}$                          | 50         | 100  | 200  | 400  | 600  | 800  | 1000 | V                  |
| Maximum RMS voltage   | $V_{RMS}$                          | 35         | 70   | 140  | 280  | 420  | 560  | 700  | V                  |
| Maximum DC Blocking Voltage   | $V_{DC}$                           | 50         | 100  | 200  | 400  | 600  | 800  | 1000 | V                  |
| Maximum Average Forward Rectified Current at $T_c = 125\text{ }^\circ\text{C}$  | $I_{F(AV)}$                        | 2          |      |      |      |      |      |      | A                  |
| Peak Forward Surge Current 8.3 ms Single Half Sine Wave Superimposed on Rated Load  | $I_{FSM}$                          | 50         |      |      |      |      |      |      | A                  |
| Maximum Instantaneous Forward Voltage at 2 A  | $V_F$                              | 1.1        |      |      |      |      |      |      | V                  |
| Maximum DC Reverse Current $T_a = 25\text{ }^\circ\text{C}$<br>at Rated DC Blocking Voltage $T_a = 125\text{ }^\circ\text{C}$ | $I_R$                              | 5<br>100   |      |      |      |      |      |      | $\mu\text{A}$      |
| Typical Junction Capacitance <sup>(1)</sup>   | $C_j$                              | 22         |      |      |      |      |      |      | pF                 |
| Typical Thermal Resistance <sup>(2)</sup>   | $R_{\theta JA}$<br>$R_{\theta JC}$ | 65<br>20   |      |      |      |      |      |      | $^\circ\text{C/W}$ |
| Operating and Storage Temperature Range   | $T_j, T_{stg}$                     | -55 ~ +150 |      |      |      |      |      |      | $^\circ\text{C}$   |

1) Measured at 1 MHz and applied reverse voltage of 4 V D.C

2) P.C.B. mounted with 0.2 X 0.2" (5 X 5 mm) copper pad areas.



# S2AF THRU S2MF Surface Mount Standard Rectifiers

## Characteristic Curves ( $T_A=25^\circ\text{C}$ unless otherwise noted)

Fig.1 Forward Current Derating Curve

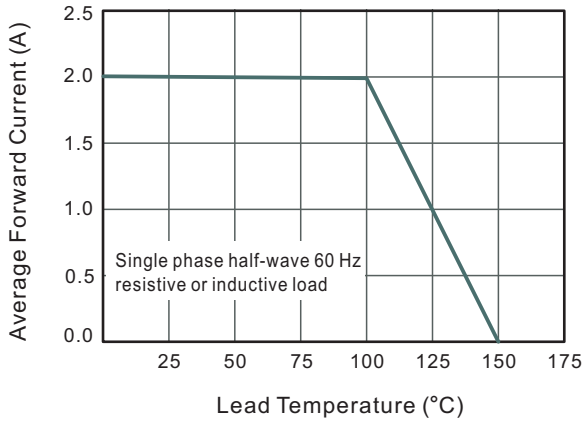

Fig.2 Typical Instantaneous Reverse Characteristics

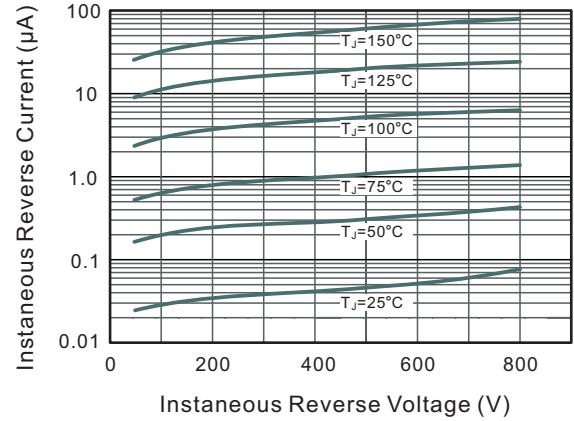

Fig.3 Typical Forward Characteristic

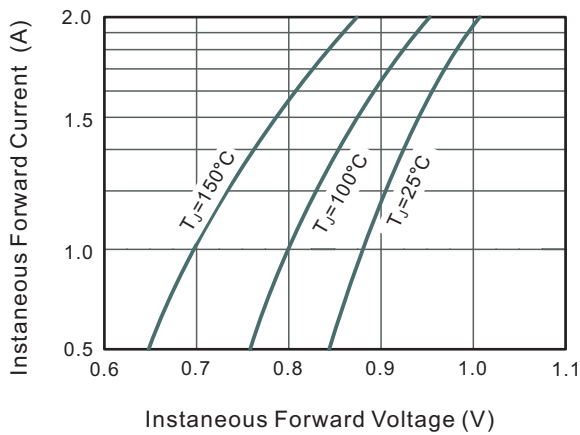

Fig.4 Typical Junction Capacitance

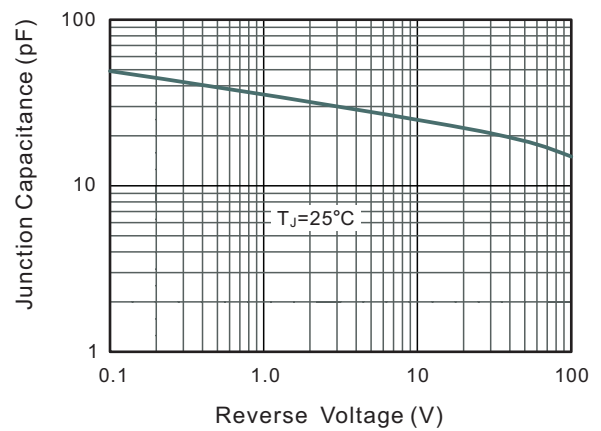
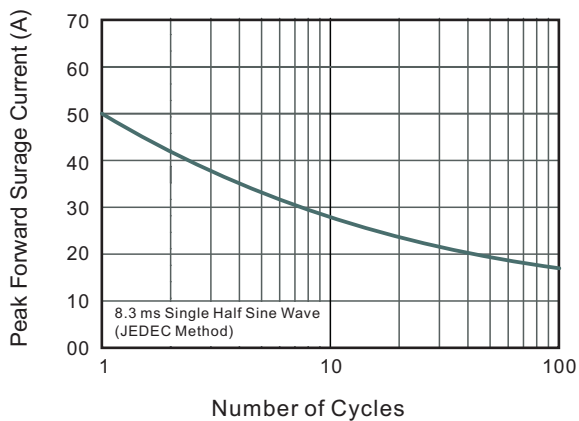

Fig.5 Maximum Non-Repetitive Peak Forward Surge Current





# S2AF THRU S2MF Surface Mount Standard Rectifiers

## PACKAGE OUTLINE

Plastic surface mounted package; 2 leads

SMAF

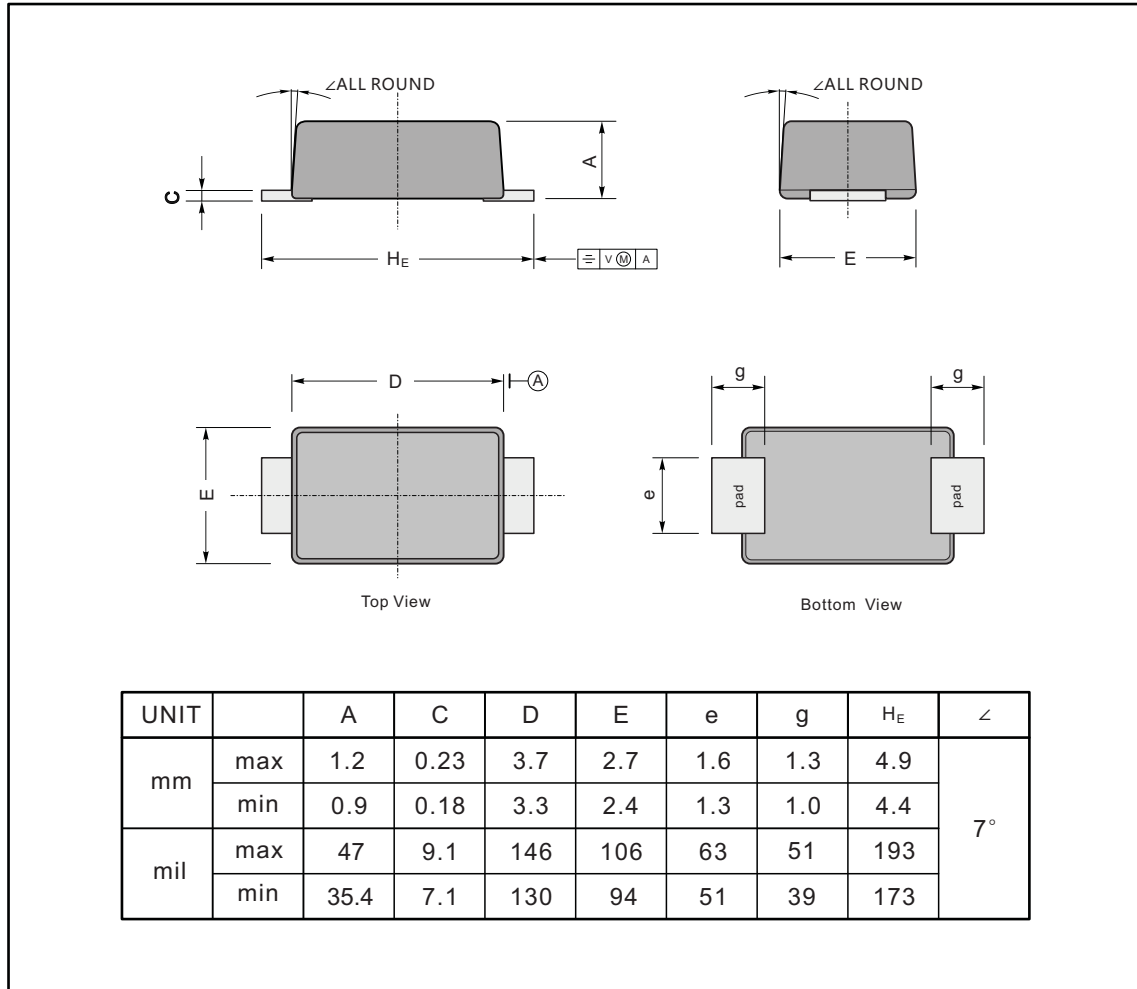

### The recommended mounting pad size

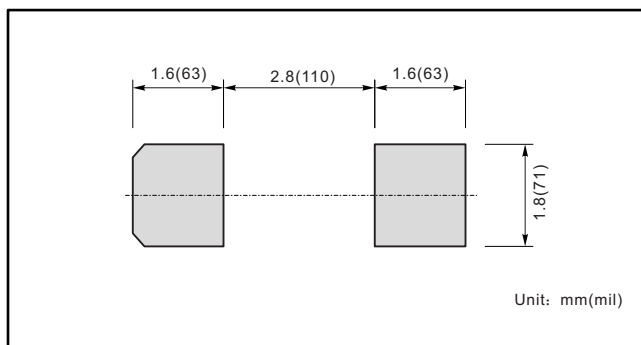

### Marking

| Type number | Marking code |
|-------------|--------------|
| S2AF        | S2A          |
| S2BF        | S2B          |
| S2DF        | S2D          |
| S2GF        | S2G          |
| S2JF        | S2J          |
| S2KF        | S2K          |
| S2MF        | S2M          |