

68V N-Channel Power MOSFET

DESCRIPTION

The MPG08N68 uses advanced trench technology to provide excellent  $R_{DS(ON)}$ , low gate charge. It can be used in a wide variety of applications.

KEY CHARACTERISTICS

- ①  $V_{DS} = 68V, I_D = 100A$
- ②  $R_{DS(ON)} < 7.5m\Omega @ V_{GS}=10V$
- ③ Special process technology for high ESD capability
- ④ High density cell design for ultra low  $R_{dson}$
- ⑤ Fully characterized avalanche voltage and current
- ⑥ Good stability and uniformity with high EAS
- ⑦ Excellent package for good heat dissipation

Application

- ① Power switching application
- ② Hard switched and High frequency circuits
- ③ Uninterruptible power supply

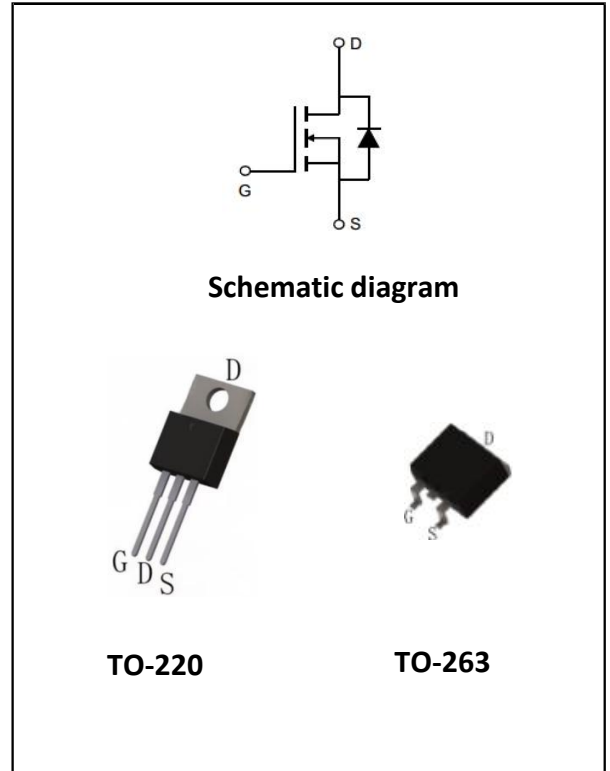

Package Marking And Ordering Information

Device Marking	Ordering Codes	Package	Product Code	Packing
08N68	MPG08N68-S	TO-263	MPG08N68S	Reel
08N68	MPG08N68-P	TO-220	MPG08N68P	Tube

Absolute Maximum Ratings (TA=25°C unless otherwise noted)

Parameter	Symbol	Limit	Unit
Drain-Source Voltage	$V_{DS}$	68	V
Gate-Source Voltage	$V_{GS}$	±20	V
Drain Current-Continuous	$I_D$	100	A
Drain Current-Pulsed (Note 1)	$I_{DM}$	340	A
Maximum Power Dissipation(Tc=25°C)	$P_D$	125	W
Single pulse avalanche energy(Note 2)	$E_{AS}$	370	mJ
Operating Junction and Storage Temperature Range	$T_J, T_{STG}$	-55 To 175	°C



## Thermal Characteristic

Thermal Resistance,Junction-to-Case	$R_{\theta JC}$	1.2	$^{\circ}\text{C}/\text{W}$
-------------------------------------	-----------------	-----	-----------------------------

Electrical Characteristics (TA=25 $^{\circ}\text{C}$  unless otherwise noted)

Parameter	Symbol	Condition	Min	Typ	Max	Unit
<b>Off Characteristics</b>						
Drain-Source Breakdown Voltage	$BV_{DSS}$	$V_{GS}=0V, I_D=250\mu A$	68	-	-	V
Zero Gate Voltage Drain Current	$I_{DSS}$	$V_{DS}=68V, V_{GS}=0V$	-	-	1	$\mu A$
Gate-Body Leakage Current	$I_{GSS}$	$V_{GS}=\pm 20V, V_{DS}=0V$	-	-	$\pm 100$	nA
<b>On Characteristics</b>						
Gate Threshold Voltage	$V_{GS(th)}$	$V_{DS}=V_{GS}, I_D=250\mu A$	2	3	4	V
Drain-Source On-State Resistance <sup>(Note 3)</sup>	$R_{DS(ON)}$	$V_{GS}=10V, I_D=45A$	-	6.5	7.5	m $\Omega$
Forward Transconductance	$G_{FS}$	$V_{DS}=10V, I_D=20A$	-	20	-	S
<b>Dynamic Characteristics</b>						
Input Capacitance	$C_{iss}$	$V_{DS}=30V, V_{GS}=0V,$ $F=1.0\text{MHz}$	-	3200	-	pF
Output Capacitance	$C_{oss}$		-	440	-	pF
Reverse Transfer Capacitance	$C_{rss}$		-	180	-	pF
<b>Switching Characteristics</b> <sup>(Note 4)</sup>						
Turn-on Delay Time	$t_{d(on)}$	$V_{DD}=30V, I_D=30A,$ $V_{GS}=10V, R_{GEN}=6\Omega$	-	16	-	nS
Turn-on Rise Time	$t_r$		-	95	-	nS
Turn-Off Delay Time	$t_{d(off)}$		-	47	-	nS
Turn-Off Fall Time	$t_f$		-	31	-	nS
Total Gate Charge	$Q_g$	$V_{DS}=30V, I_D=20A$ $V_{GS}=10V$	-	40	-	nC
Gate-Source Charge	$Q_{gs}$		-	11	-	nC
Gate-Drain Charge	$Q_{gd}$		-	15	-	nC
<b>Drain-Source Diode Characteristics</b>						
Diode Forward Voltage <sup>(Note 3)</sup>	$V_{SD}$	$V_{GS}=0V, I_S=90A$	-	-	1.2	V

## Notes:

1. Repetitive Rating: Pulse width limited by maximum junction temperature.
2.  $E_{AS}$  condition :  $T_j=25^{\circ}\text{C}, V_{DD}=30V, V_G=10V, L=0.5\text{mH}, R_g=25\Omega$
3. Pulse Test: Pulse Width  $\leq 300\mu s$ , Duty Cycle  $\leq 2\%$ .
4. Guaranteed by design, not subject to production.

Characteristics Curves

Figure 1 Output Characteristics

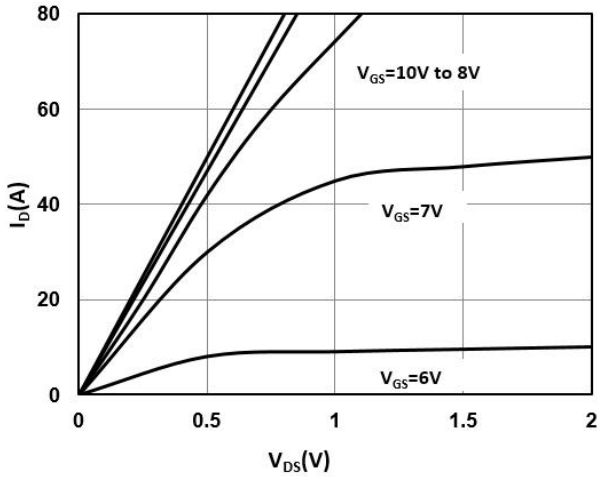

Figure 2 Transfer Characteristics

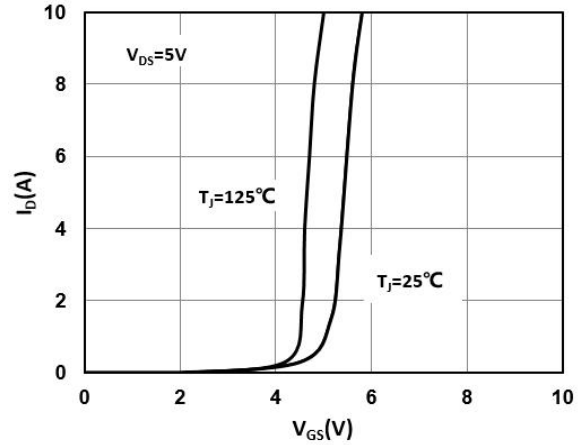

Figure 3 On-Resistance vs.  $I_D$  and  $V_{GS}$

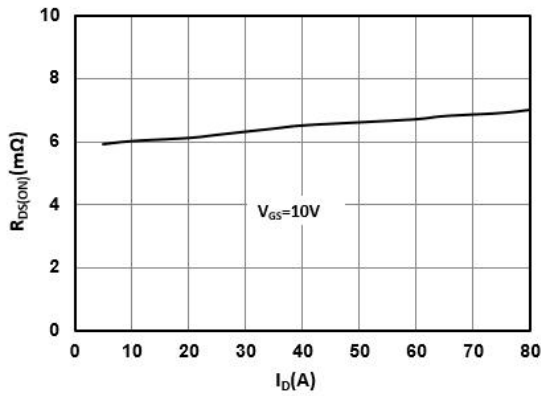

Figure 4 On-Resistance vs. Junction Temperature

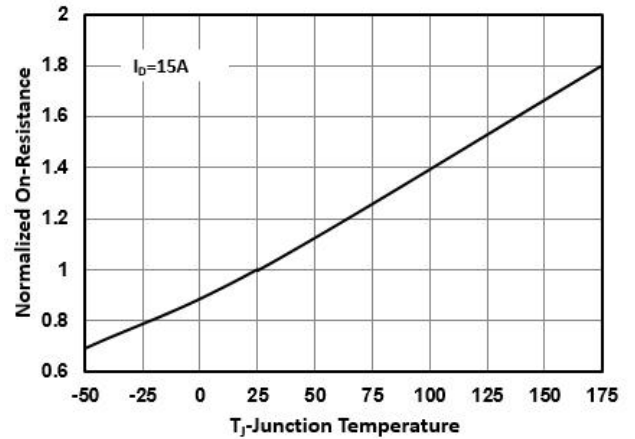

Figure 5 On-Resistance vs.  $V_{GS}$

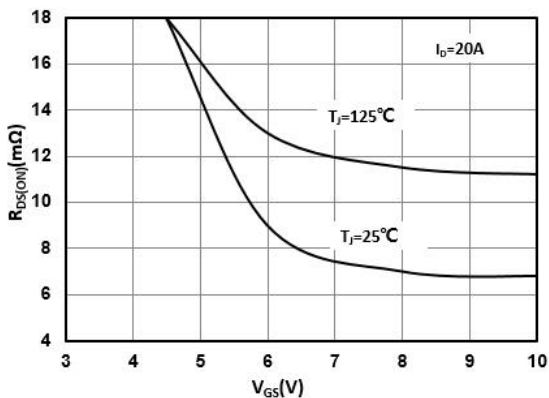

Figure 6 Body Diode Forward Voltage

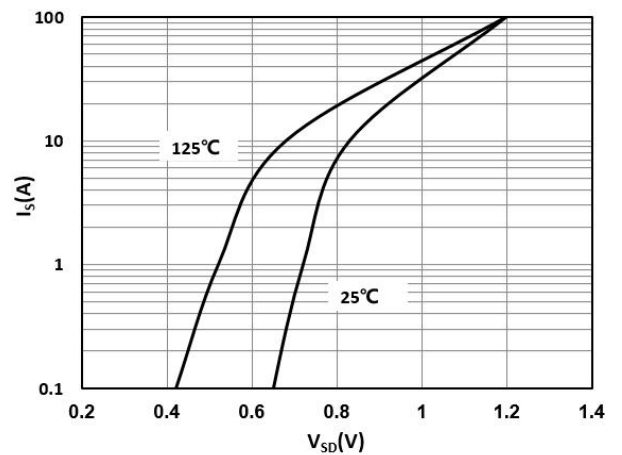

Figure 7 Gate-Charge Characteristics

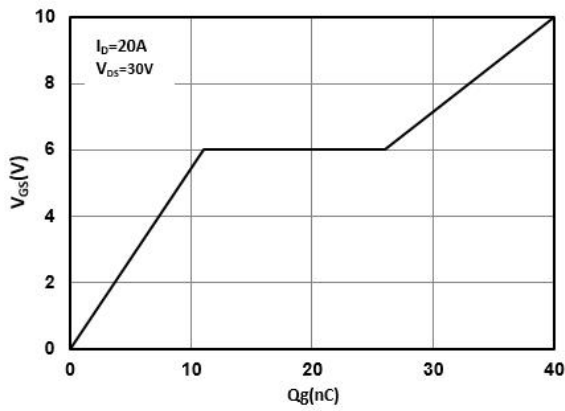

Figure 8 Capacitance Characteristics

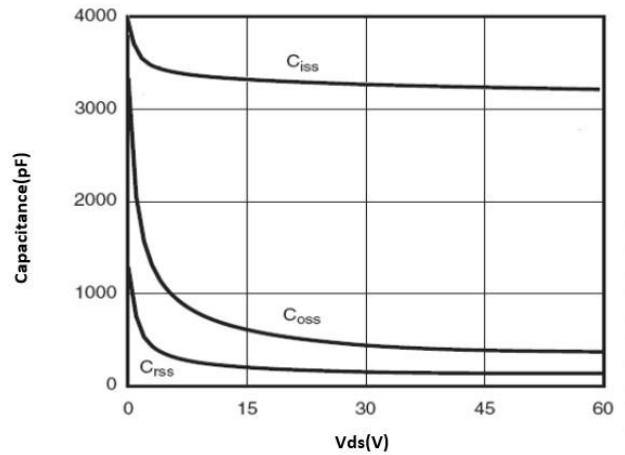

Figure 9 Maximum Forward Biased Safe Operation Area

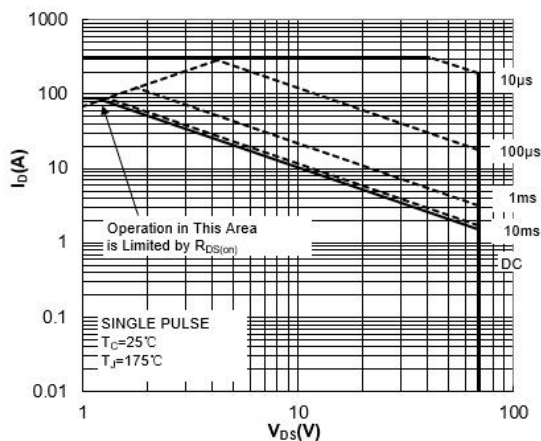

Figure 10 Single Pulse Power Rating Junction-to-Ambient

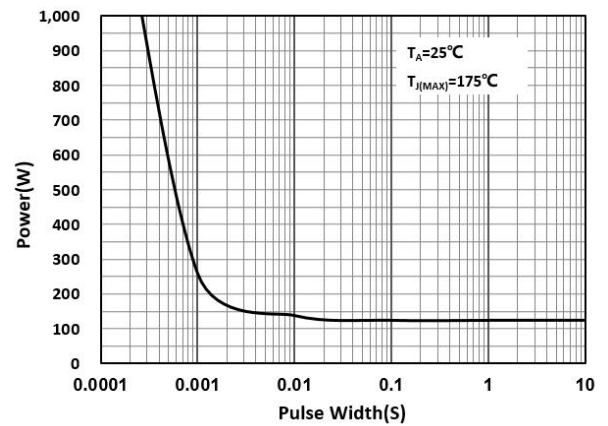
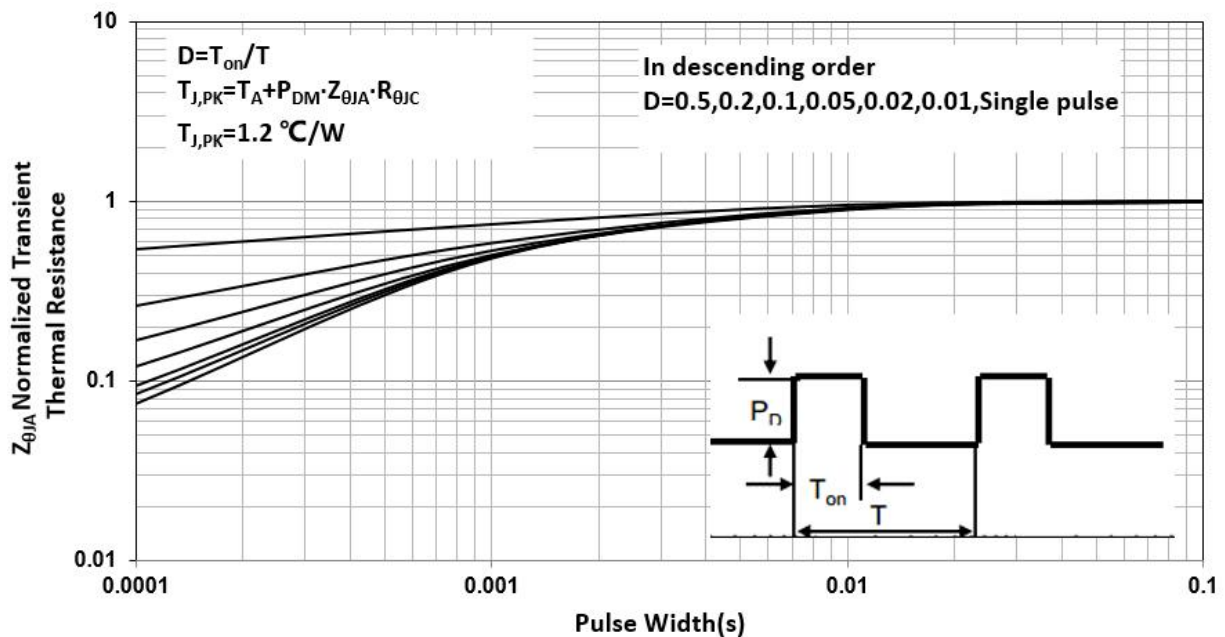
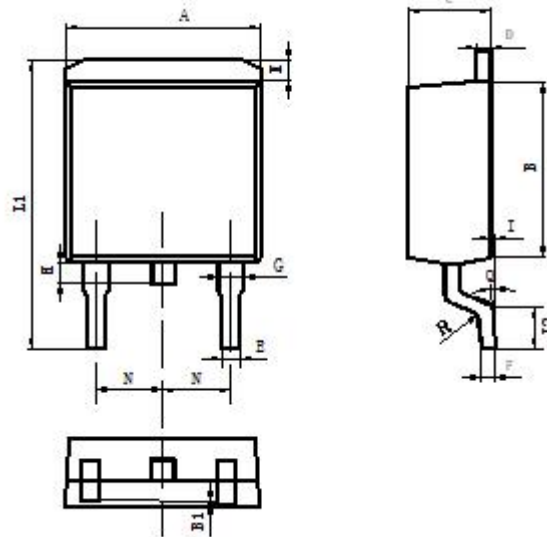

Figure 11 Normalized Maximum Transient Thermal Impedance



Package Description



Items	Values(mm)	
	MIN	MAX
A	9.80	10.40
B	8.90	9.50
B1	0	0.10
C	4.40	4.80
D	1.16	1.37
E	0.70	0.95
F	0.30	0.60
G	1.07	1.47
H	1.30	1.80
K	0.95	1.37
L1	14.50	16.50
L2	1.60	2.30
I	0	0.2
Q	0°	8°
R	0.4	0.4
N	2.39	2.69

TO-263 Package

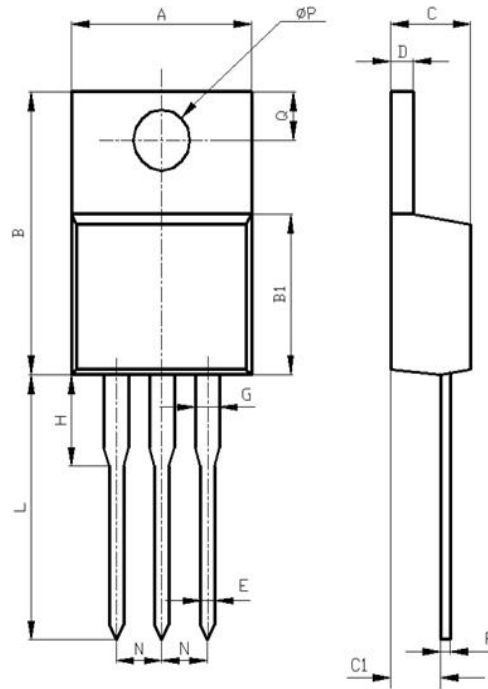

Items	Values(mm)	
	MIN	MAX
A	9.60	10.6
B	15.0	16.0
B1	8.90	9.50
C	4.30	4.80
C1	2.30	3.10
D	1.20	1.40
E	0.70	0.90
F	0.30	0.60
G	1.17	1.37
H	2.70	3.80
L	12.6	14.8
N	2.34	2.74
Q	2.40	3.00
φp	3.50	3.90

TO-220 Package



迈诺斯科技

**MPG08N68**

**NOTE:**

1. Exceeding the maximum ratings of the device in performance may cause damage to the device, even the permanent failure, which may affect the dependability of the machine. Please do not exceed the absolute maximum ratings of the device when circuit designing.
2. When installing the heat sink, please pay attention to the torsional moment and the smoothness of the heat sink.
3. MOSFETs is the device which is sensitive to the static electricity, it is necessary to protect the device from being damaged by the static electricity when using it.
4. Shenzhen Minos reserves the right to make changes in this specification sheet and is subject to change without prior notice.

**CONTACT:**

**深圳市迈诺斯科技有限公司（总部）**

地址：深圳市福田区华富街道田面社区深南中路4026号田面城市大厦22B-22C

邮编：518025

电话：0755-83273777