

THIS DRAWING IS UNPUBLISHED. RELEASED FOR PUBLICATION
 © COPYRIGHT - ALL RIGHTS RESERVED.

LOC H
 DIST -

REVISIONS

P	LTR	DESCRIPTION	DATE	DWN	APVD
	S4	PACKAGING BLISTER MATERIAL CHANGE	08MAY2015	NV	PS

REFERENCE MATING INTERFACE PATTERN:
 1,27 STAGGERED PITCH x 1,5 ROW-DISTANCE.

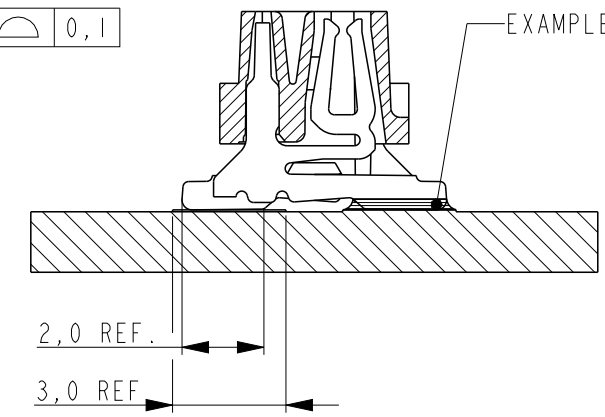
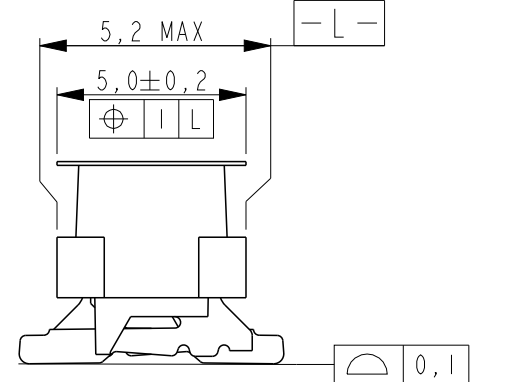
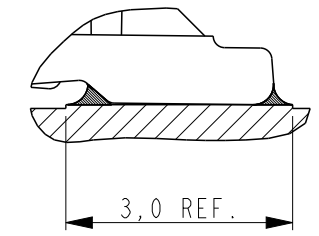
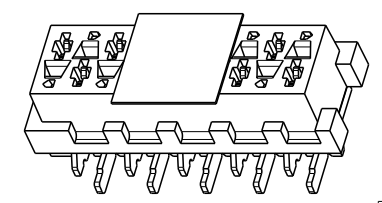
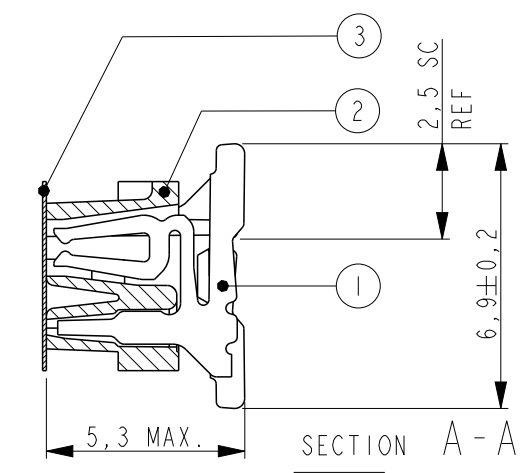
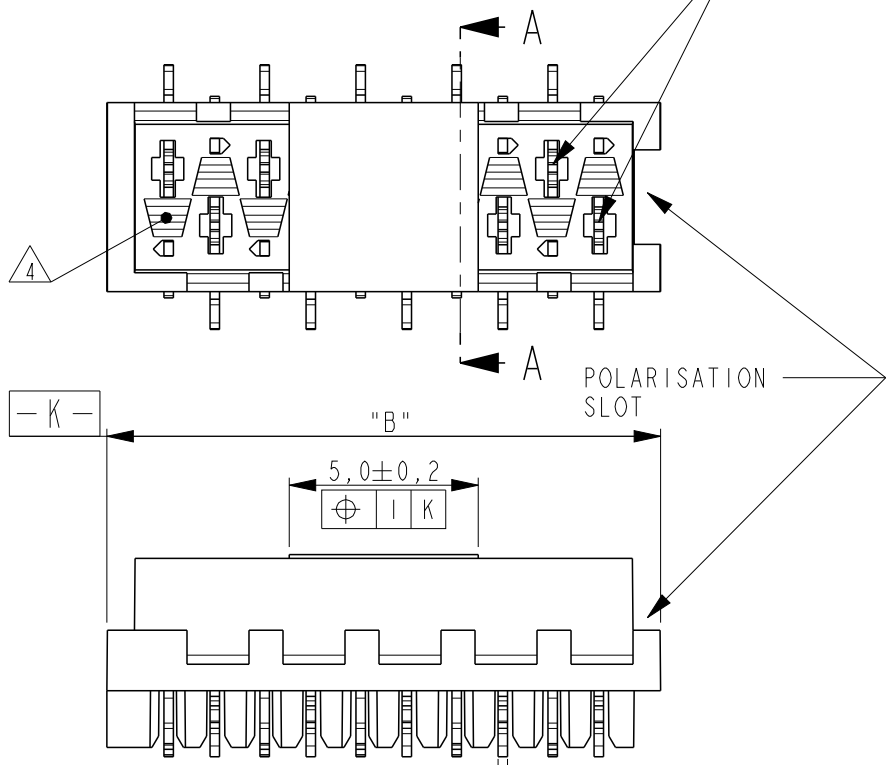

PART NUMBER VAC. TAPE. ¹	PART REV	PART NUMBER ³	PART REV	NR. OF POS. "n"	"A"	"B" MAX.
7-188275-4	U	0-188275-4	U	4	3,81	7,1
7-188275-6	U	0-188275-6	U	6	6,35	9,7
7-188275-8	U	0-188275-8	U	8	8,89	12,2
8-188275-0	U	1-188275-0	U	10	11,43	14,7
8-188275-2	U	1-188275-2	U	12	13,97	17,3
8-188275-4	U	1-188275-4	U	14	16,51	19,8
8-188275-6	U	1-188275-6	U	16	19,05	22,4
8-188275-8	V	1-188275-8	V	18	21,59	24,9
9-188275-0	U	2-188275-0	U	20	24,13	27,5

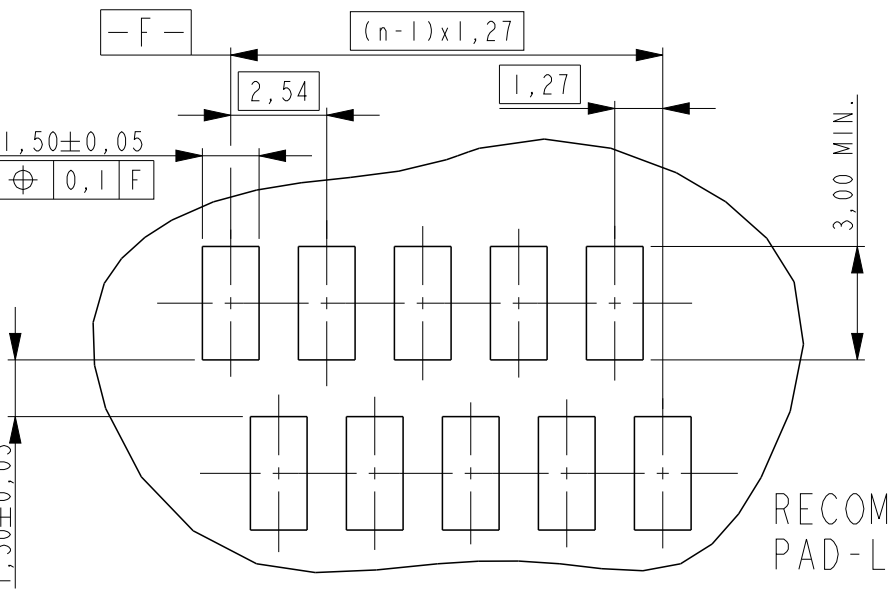
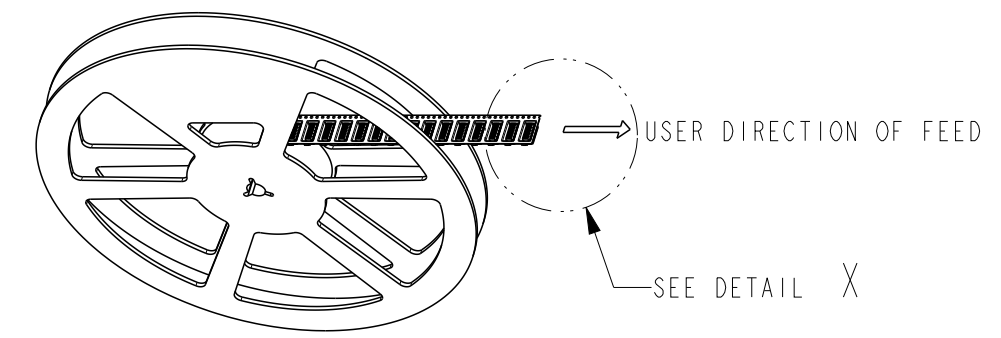
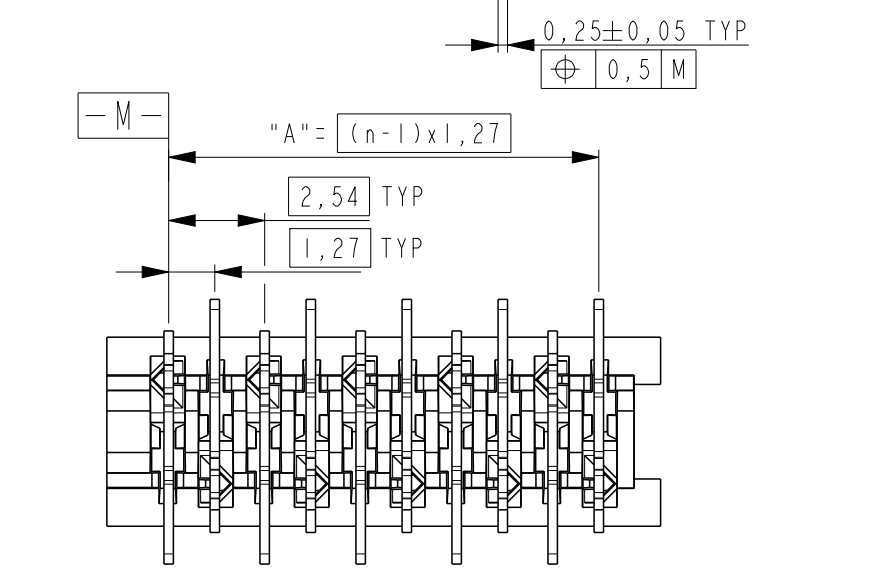

NOTES:

- 1 TAPE FOR VACUUM P&P ONLY FOR DASHNUMBERS 7- /8- /9-
- 2 FOR PACKAGING SEE SHEET 2 OF 2
- 3 WITHOUT VACUUM TAPE.
- 4 CORING-OUTS FOR MANUFACTURING PURPOSE ONLY. SHAPE MAY VARY, BUT IS NOT FUNCTIONAL FOR THE APPLICATION.
- 5 SHOWN IS A 10 POSITION CONNECTOR.

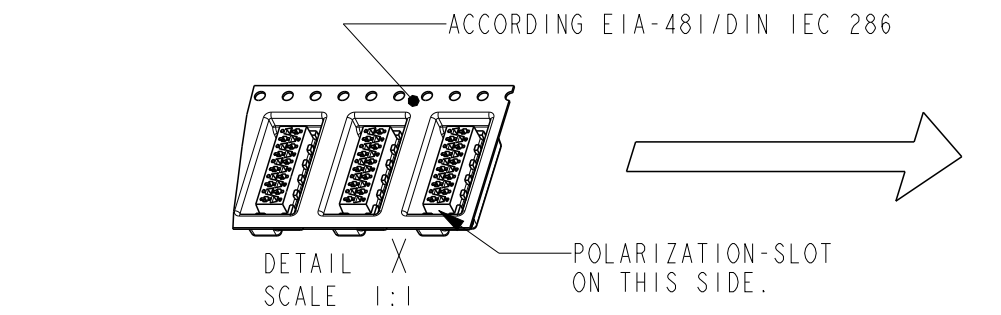

ITEM NO.	COMPONENT DESCRIPTION	MATERIAL	FINISH / COLOR
3	PICK & PLACE TAPE	KAPTON	AMBER TRANSPARENT
2	FEMALE HOUSING	POLYAMIDE 4/6,GF	RED
1	FEMALE CONTACT	PHOSPHOR BRONZE	TIN OVER NICKEL

THIS DRAWING IS A CONTROLLED DOCUMENT.		DWN M. GOSSELINK
DIMENSIONS: mm		CHK -
TOLERANCES UNLESS OTHERWISE SPECIFIED:		APVD -
0 PLC	±-	PRODUCT SPEC 108-19052
1 PLC	±-	APPLICATION SPEC 114-13318
2 PLC	±-	WEIGHT -
3 PLC	±-	CUSTOMER DRAWING
4 PLC	±-	
ANGLES	±-	
FINISH	SEE TABLE	

TE Connectivity

STE

CONNECTOR, FEMALE-ON-BOARD TOP-ENTRY, SMD, Micro-MatCh

SIZE A3	CAGE CODE 00779	DRAWING NO C-188275	RESTRICTED TO -
---------	-----------------	---------------------	-----------------

SCALE 5:1 SHEET 1 OF 2 REV S4

THIS DRAWING IS UNPUBLISHED.

RELEASED FOR PUBLICATION

© COPYRIGHT -

ALL RIGHTS RESERVED.

LOC
H

DIST
-

REVISIONS

P LTR

DESCRIPTION

DATE

DWN

APVD

SEE SHEET 1

TAPE WIDTH 24 mm

TAPE WIDTH 44 mm

TAPE WIDTH 44 mm

TAPE WIDTH 44 mm

TAPE WIDTH 44 mm

TAPE WIDTH 44 mm

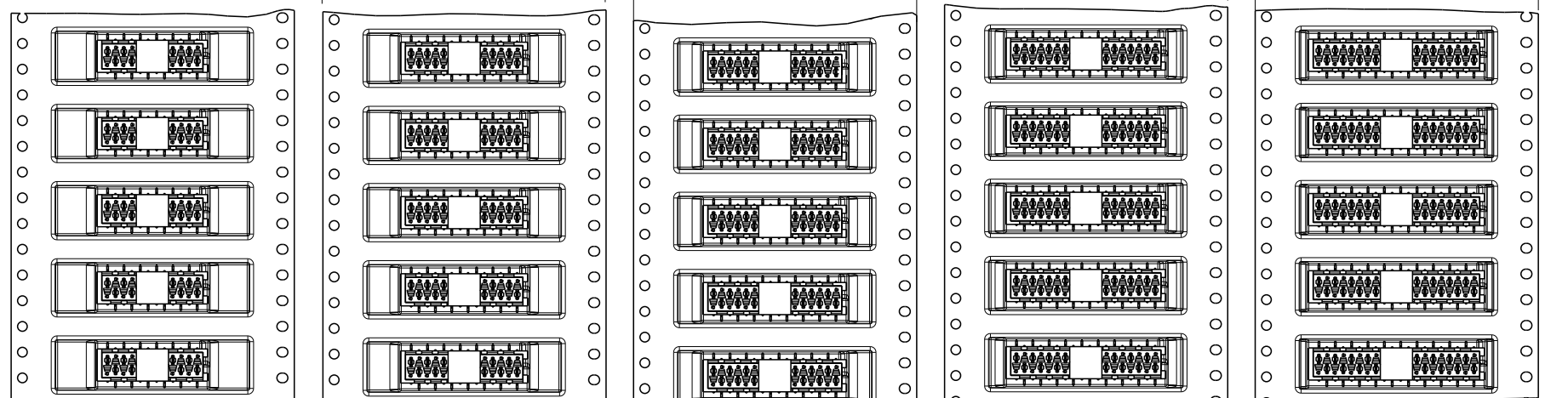
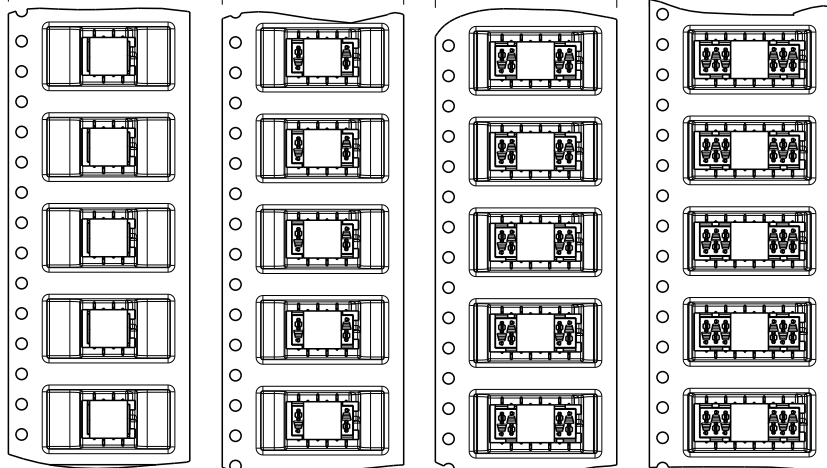

7-188275-4	7-188275-6	7-188275-8	8-188275-0
4 POSITION	6 POSITION	8 POSITION	10 POSITION
0-188275-4	0-188275-6	0-188275-8	1-188275-0

8-188275-2	8-188275-4	8-188275-6	8-188275-8	9-188275-0
12 POSITION	14 POSITION	16 POSITION	18 POSITION	20 POSITION
1-188275-2	1-188275-4	1-188275-6	1-188275-8	2-188275-0

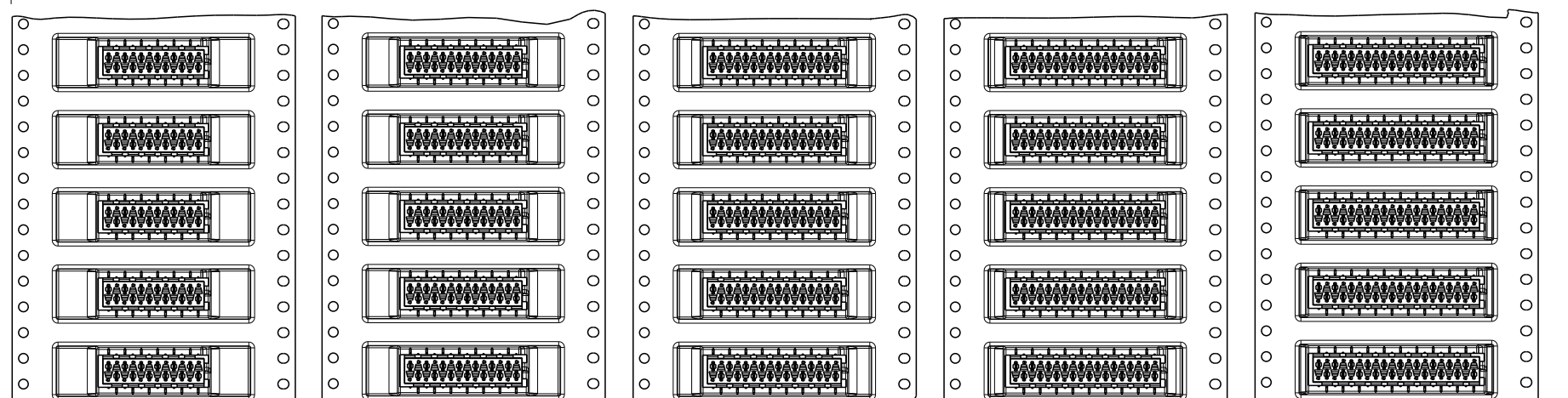
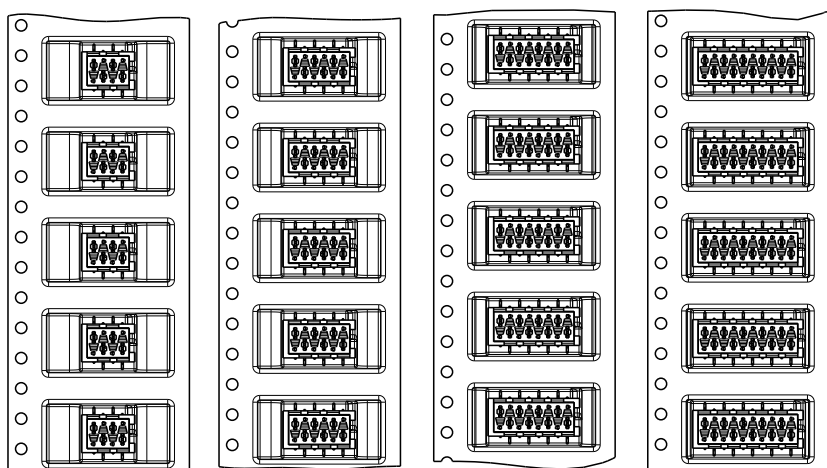

THIS DRAWING IS A CONTROLLED DOCUMENT.

DWN
M. GOSSELINK
CHK
-
APVD
-
PRODUCT SPEC
108-19052
APPLICATION SPEC
114-13318
WEIGHT
-



NAME
CONNECTOR,
FEMALE-ON-BOARD TOP-ENTRY,
SMD, Micro-MaTch

DIMENSIONS:
mm

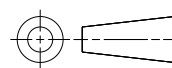

TOLERANCES UNLESS OTHERWISE SPECIFIED:
0 PLC ±-
1 PLC ±0.1
2 PLC ±0.05
3 PLC ±-
4 PLC ±-
ANGLES ±-
FINISH -

MATERIAL -

CUSTOMER DRAWING
SCALE 1:1
SHEET 2 OF 2
REV S4

SIZE A3
CAGE CODE 00779
DRAWING NO C-188275
RESTRICTED TO -

Mouser Electronics

Authorized Distributor

Click to View Pricing, Inventory, Delivery & Lifecycle Information:

[TE Connectivity:](#)

[8-188275-2](#)