

For Fan Motor Driver

Fractional Pulse Rate Converter (Conversion Ratio, 21:12)

BU6823G

General Description

This IC converts the input clock signal by 12/21 ratio and output it. It is the best when need to output the FG signal equivalent to the 8-pole motor when using the 14-pole motor with the FG signal generated from the Hall sensor signals.

Features

- 5V Power Supply
- Conversion Ratio, 21:12
- Input Frequency Range: 5 Hz to 5 kHz
- Small Package, SSOP5

Applications

- Air Conditioners; Air Purifiers

Key Specifications

- Input Frequency Range: 5 Hz to 5 kHz
- Driver Output Current: ± 5 mA (Max)
- Maximum Junction Temperature: +125 °C

Package

SSOP5

W(Typ) x D(Typ) x H(Max)

2.90 mm x 2.80 mm x 1.25 mm

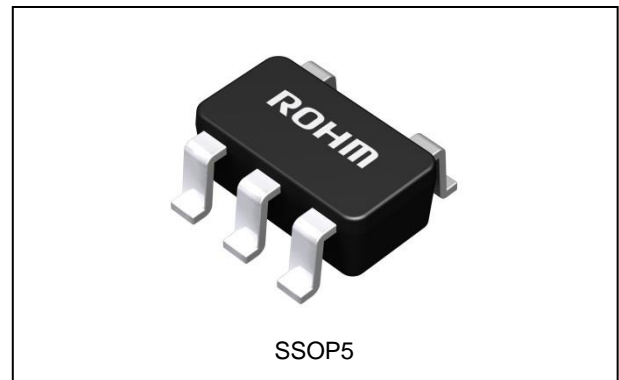

Typical Application Circuit

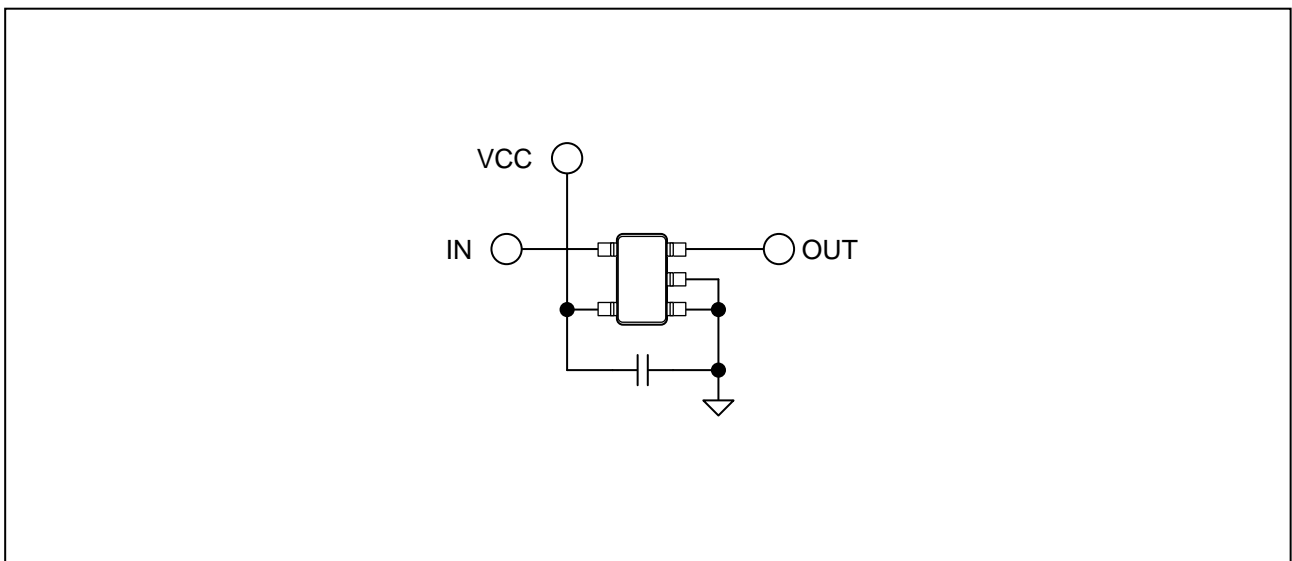

Figure 1. Application Circuit Example

Contents

General Description	1
Features.....	1
Applications	1
Key Specifications	1
Package	1
Typical Application Circuit	1
Contents	2
Block Diagram and Pin Configuration	3
Pin Description.....	3
Description of Blocks	3
Absolute Maximum Ratings	4
Thermal Resistance.....	4
Recommended Operating Conditions	5
Electrical Characteristics.....	5
Typical Performance Curves (Reference Data)	6
Timing Chart	8
I/O Equivalence Circuits.....	8
Operational Notes.....	9
Ordering Information.....	10
Marking Diagram	10
Physical Dimension and Packing Information	11
Revision History.....	12

Block Diagram and Pin Configuration

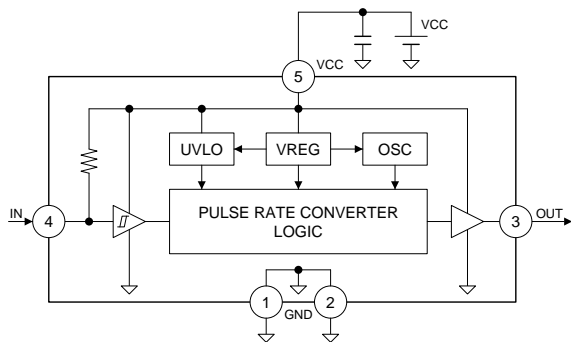

Figure 2. Block Diagram

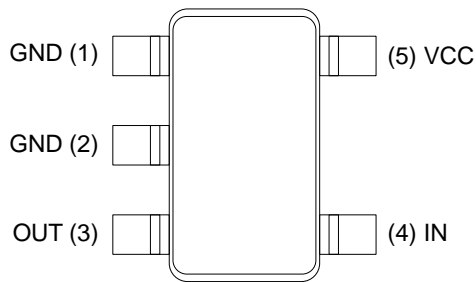

Figure 3. Pin Configuration (Top View)

Pin Description

Pin	Name	Function	Pin	Name	Function
1	GND	Ground	5	VCC	Power supply
2	GND	Ground	-	-	-
3	OUT	Converted signal output	4	IN	Signal input pin

Description of Blocks

1. Pulse Rate Conversion Logic

It divides the input clock signal by 12/21, and output the converted signal. Signal processing is performed with reference to the fall edge of the input signal.

In addition, when the input signal frequency is out of range at signal conversion and it is judged to be too low frequency, the internal logic circuit outputs no conversion signal (pass through). On the other hand, when it is judged to be too high frequency, it outputs 35 kHz (Typ) signal.

2. Signal Input Pin

The IN pin is pulled up to VCC internally by a 500 kΩ (Typ) resistor. When using in conjunction with the open-collector / drain output, the IN pin can be connected directly.

3. Signal Output Pin

The OUT pin is CMOS output. When connecting to the base pin of a bipolar transistor, please do not exceed the rated current by taking countermeasure such as inserting a current limiting resistor.

4. Under Voltage Lock Out (UVLO) Circuit

To secure the lowest power supply voltage necessary to operate the internal circuit, and to prevent under voltage malfunctions, an UVLO circuit is built into the internal circuit. When the power supply voltage falls to V_{UVL} and below, the internal circuit forces output low. When the voltage rises to V_{UVH} and above, the UVLO circuit ends the lock out operation and returns to normal operation.

Absolute Maximum Ratings (T_j=25 °C)

Parameter	Symbol	Rating	Unit
Supply Voltage	V _{CC}	7.0 ^(Note 1)	V
Input Voltage	V _{IN}	-0.3 to V _{CC}	V
Maximum Input Frequency	f _{INMAX}	10	kHz
Driver Outputs	I _{OMAX}	±5 ^(Note 1)	mA
Storage Temperature Range	T _{stg}	-55 to +125	°C
Maximum Junction Temperature	T _{jmax}	125	°C

(Note) All voltages are with respect to ground unless otherwise specified.

(Note 1) Do not exceed ASO.

Caution 1: Operating the IC over the absolute maximum ratings may damage the IC. The damage can either be a short circuit between pins or an open circuit between pins and the internal circuitry. Therefore, it is important to consider circuit protection measures, such as adding a fuse, in case the IC is operated over the absolute maximum ratings.

Caution 2: Should by any chance the maximum junction temperature rating be exceeded the rise in temperature of the chip may result in deterioration of the properties of the chip. In case of exceeding this absolute maximum rating, design a PCB with thermal resistance taken into consideration by increasing board size and copper area so as not to exceed the maximum junction temperature rating.

Thermal Resistance^(Note 2)

Parameter	Symbol	Thermal Resistance (Typ)		Unit
		1s ^(Note 4)	2s2p ^(Note 5)	
SSOP5				
Junction to Ambient	θ _{JA}	376.5	185.4	°C/W
Junction to Top Characterization Parameter ^(Note 3)	Ψ _{JT}	40	30	°C/W

(Note 2) Based on JESD51-2A(Still-Air).

(Note 3) The thermal characterization parameter to report the difference between junction temperature and the temperature at the top center of the outside surface of the component package.

(Note 4) Using a PCB board based on JESD51-3.

(Note 5) Using a PCB board based on JESD51-7.

Layer Number of Measurement Board	Material	Board Size
Single	FR-4	114.3 mm x 76.2 mm x 1.57 mmt

Top	
Copper Pattern	Thickness
Footprints and Traces	70 μm

Layer Number of Measurement Board	Material	Board Size
4 Layers	FR-4	114.3 mm x 76.2 mm x 1.6 mmt

Top		2 Internal Layers		Bottom	
Copper Pattern	Thickness	Copper Pattern	Thickness	Copper Pattern	Thickness
Footprints and Traces	70 μm	74.2 mm x 74.2 mm	35 μm	74.2 mm x 74.2 mm	70 μm

Recommended Operating Conditions ($T_j=25\text{ }^\circ\text{C}$)

Parameter	Symbol	Min	Typ	Max	Unit
Supply Voltage	V_{CC}	4.5	5.0	5.5	V
Junction Temperature	T_j	-40	-	+110	$^\circ\text{C}$
Input Frequency Range	f_{IN}	5	-	5k	Hz
Input Signal Duty Range	F_{DUTY}	15	-	85	%

(Note) All voltages are with respect to ground unless otherwise specified.

Electrical Characteristics (Unless otherwise specified $V_{CC}=5\text{ V}$ and $T_j=25\text{ }^\circ\text{C}$)

Parameter	Symbol	Min	Typ	Max	Unit	Conditions
Power Supply						
Quiescence Current	I_{CCQ}	0.3	0.46	1.0	mA	$V_{IN}=0\text{ V}$
Input						
Input Bias Current	I_{IN}	6	10	15	μA	$V_{IN}=0\text{ V}$
Input High Voltage	V_{INH}	2.0	-	V_{CC}	V	
Input Low Voltage	V_{INL}	0	-	0.8	V	
Output						
Output High Voltage	V_{OUTH}	$V_{CC}-0.40$	$V_{CC}-0.08$	V_{CC}	V	$I_o=-2\text{ mA}$
Output Low Voltage	V_{OUTL}	0	0.02	0.30	V	$I_o=2\text{ mA}$
Under Voltage Lock Out						
Release Voltage	V_{UVH}	3.3	3.6	3.9	V	
Lockout Voltage	V_{UVL}	2.7	3.0	3.3	V	

(Note) All voltages are with respect to ground unless otherwise specified.

Typical Performance Curves (Reference Data)

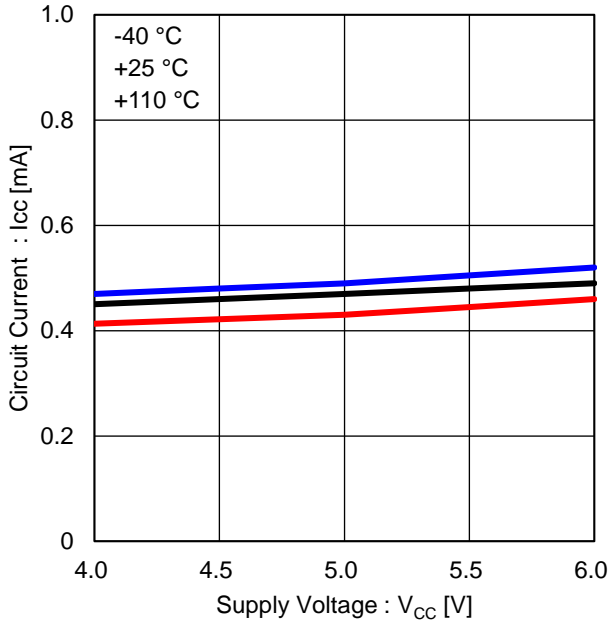

Figure 4. Operating Current (I_N = 1kHz)

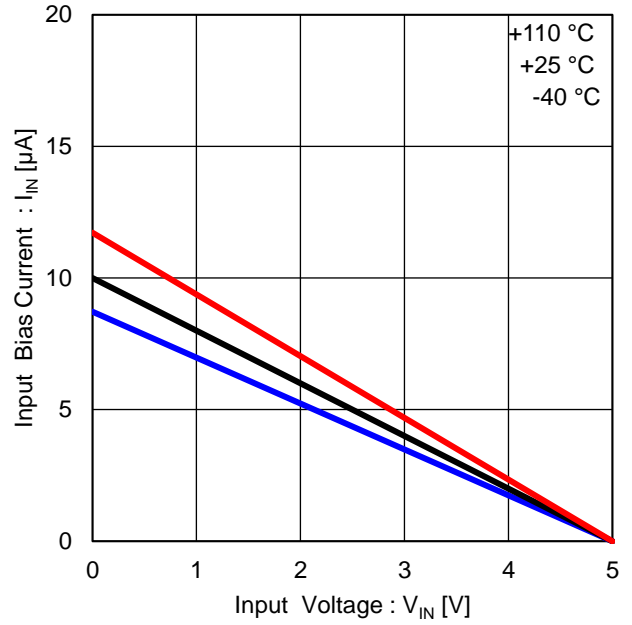

Figure 5. Input Bias Current

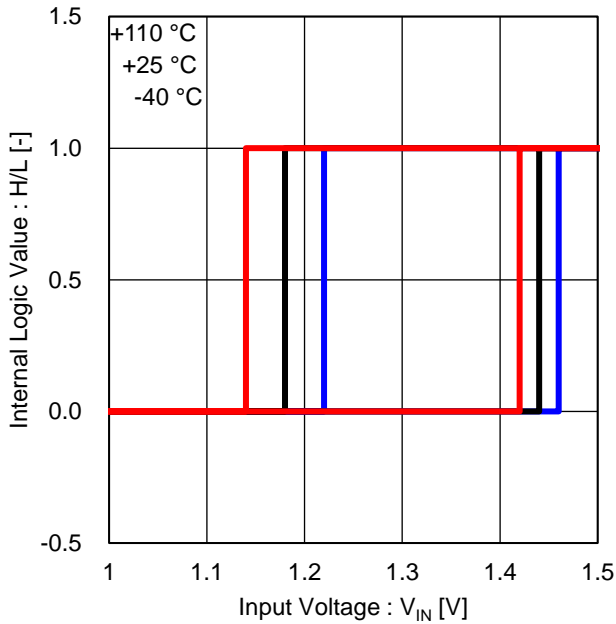

Figure 6. Input Threshold Voltage

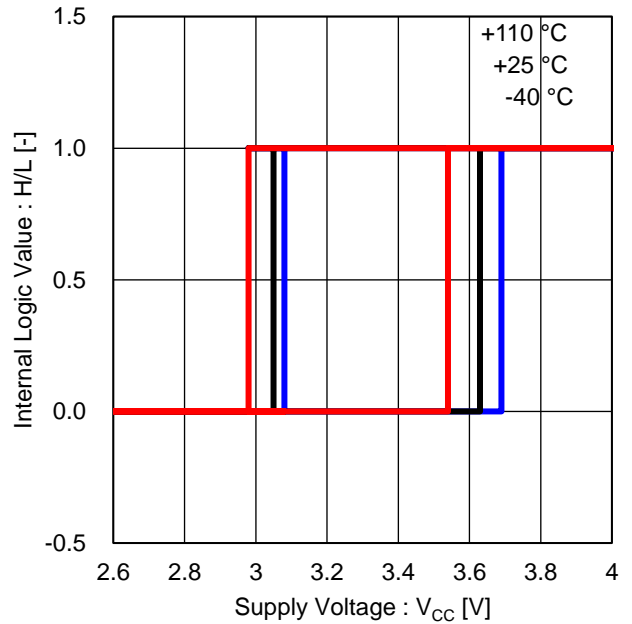

Figure 7. Under Voltage Lock Out

Typical Performance Curves (Reference Data) - continued

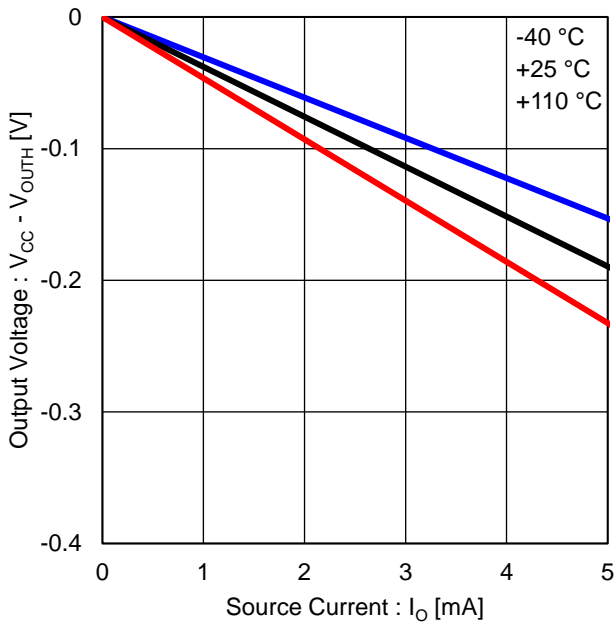

Figure 8. Output High Voltage

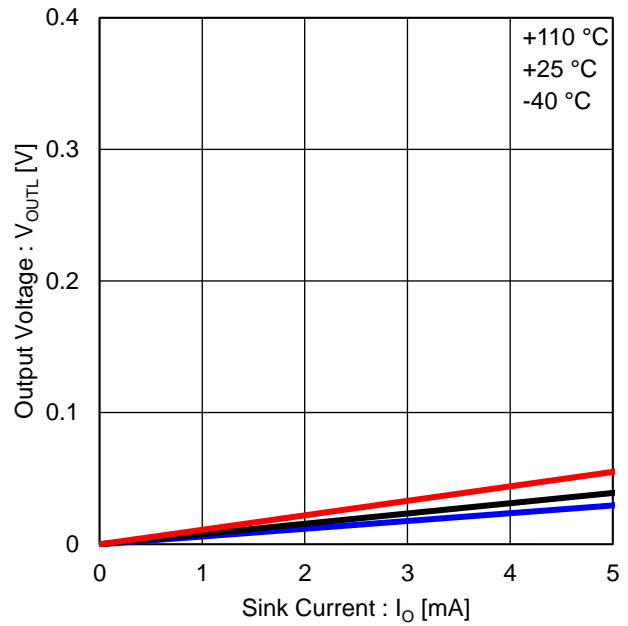

Figure 9. Output Low Voltage

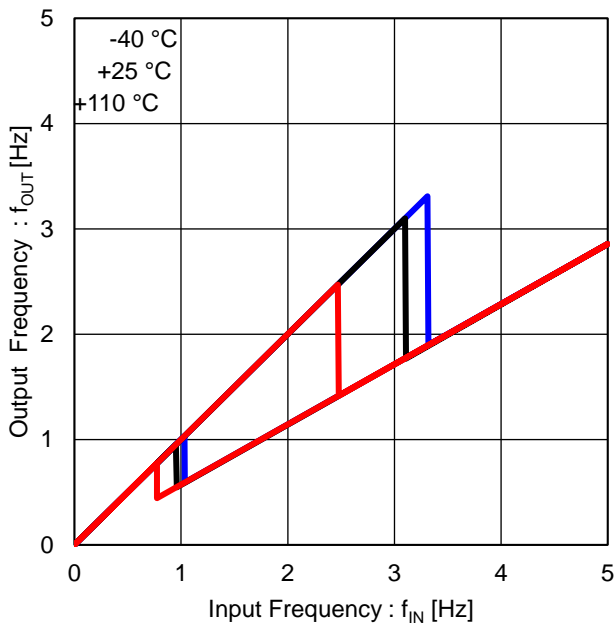

Figure 10. Output vs Input Frequency Characteristics (Low Frequency)

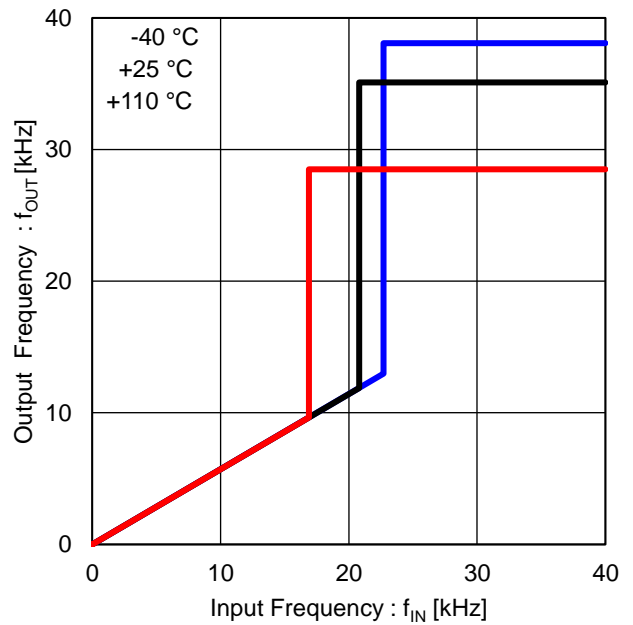

Figure 11. Output vs Input Frequency Characteristics

Timing Chart

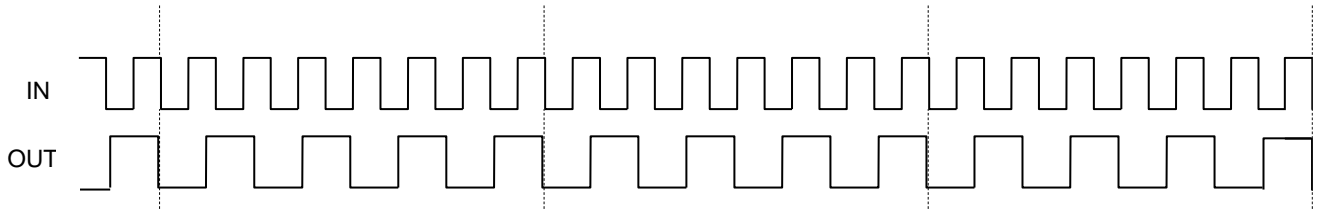

Figure 12. Timing Chart

I/O Equivalence Circuits

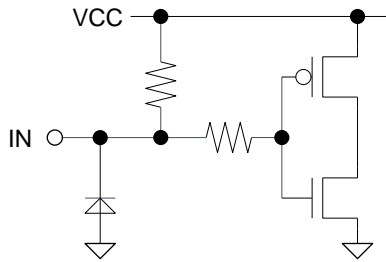

Figure 13. IN

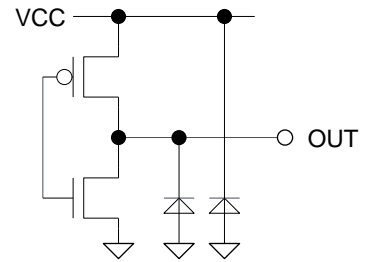

Figure 14. OUT, VCC

Operational Notes

1. Reverse Connection of Power Supply

Connecting the power supply in reverse polarity can damage the IC. Take precautions against reverse polarity when connecting the power supply, such as mounting an external diode between the power supply and the IC's power supply pins.

2. Power Supply Lines

Design the PCB layout pattern to provide low impedance supply lines. Separate the ground and supply lines of the digital and analog blocks to prevent noise in the ground and supply lines of the digital block from affecting the analog block. Furthermore, connect a capacitor to ground at all power supply pins. Consider the effect of temperature and aging on the capacitance value when using electrolytic capacitors.

3. Ground Voltage

Ensure that no pins are at a voltage below that of the ground pin at any time, even during transient condition. However, pins that drive inductive loads (e.g. motor driver outputs, DC-DC converter outputs) may inevitably go below ground due to back EMF or electromotive force. In such cases, the user should make sure that such voltages going below ground will not cause the IC and the system to malfunction by examining carefully all relevant factors and conditions such as motor characteristics, supply voltage, operating frequency and PCB wiring to name a few.

4. Ground Wiring Pattern

When using both small-signal and large-current ground traces, the two ground traces should be routed separately but connected to a single ground at the reference point of the application board to avoid fluctuations in the small-signal ground caused by large currents. Also ensure that the ground traces of external components do not cause variations on the ground voltage. The ground lines must be as short and thick as possible to reduce line impedance.

5. Recommended Operating Conditions

The function and operation of the IC are guaranteed within the range specified by the recommended operating conditions. The characteristic values are guaranteed only under the conditions of each item specified by the electrical characteristics.

6. Inrush Current

When power is first supplied to the IC, it is possible that the internal logic may be unstable and inrush current may flow instantaneously due to the internal powering sequence and delays, especially if the IC has more than one power supply. Therefore, give special consideration to power coupling capacitance, power wiring, width of ground wiring, and routing of connections.

7. Operation Under Strong Electromagnetic Field

Operating the IC in the presence of a strong electromagnetic field may cause the IC to malfunction.

8. Testing on Application Boards

When testing the IC on an application board, connecting a capacitor directly to a low-impedance output pin may subject the IC to stress. Always discharge capacitors completely after each process or step. The IC's power supply should always be turned off completely before connecting or removing it from the test setup during the inspection process. To prevent damage from static discharge, ground the IC during assembly and use similar precautions during transport and storage.

9. Inter-pin Short and Mounting Errors

Ensure that the direction and position are correct when mounting the IC on the PCB. Incorrect mounting may result in damaging the IC. Avoid nearby pins being shorted to each other especially to ground, power supply and output pin. Inter-pin shorts could be due to many reasons such as metal particles, water droplets (in very humid environment) and unintentional solder bridge deposited in between pins during assembly to name a few.

10. Regarding the Input Pin of the IC

In the construction of this IC, P-N junctions are inevitably formed creating parasitic diodes or transistors. The operation of these parasitic elements can result in mutual interference among circuits, operational faults, or physical damage. Therefore, conditions which cause these parasitic elements to operate, such as applying a voltage to an input pin lower than the ground voltage should be avoided. Furthermore, do not apply a voltage to the input pins when no power supply voltage is applied to the IC. Even if the power supply voltage is applied, make sure that the input pins have voltages within the values specified in the electrical characteristics of this IC.

Ordering Information

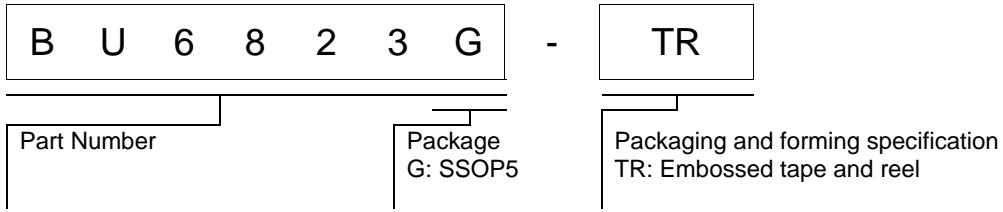

Marking Diagram

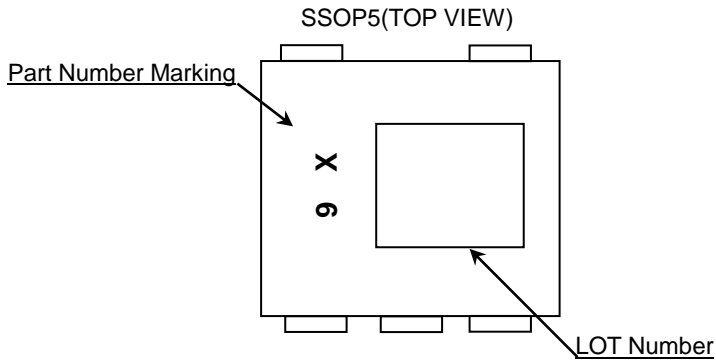

Physical Dimension and Packing Information

Package Name	SSOP5
--------------	-------

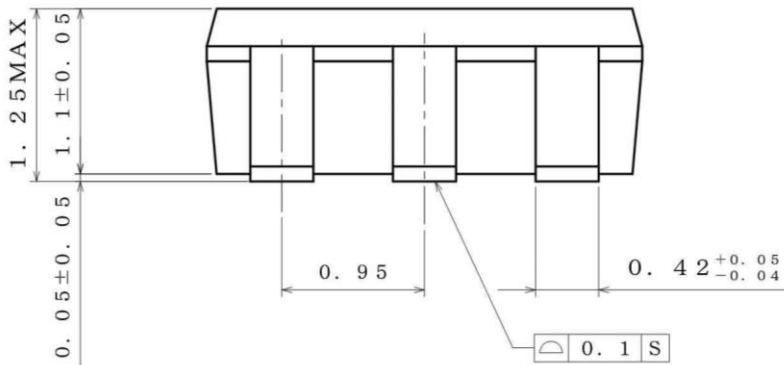
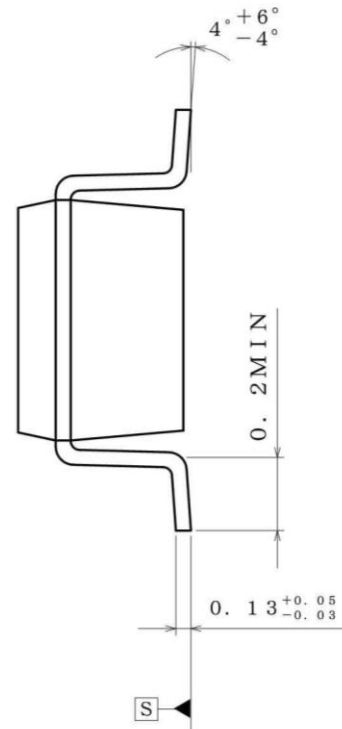
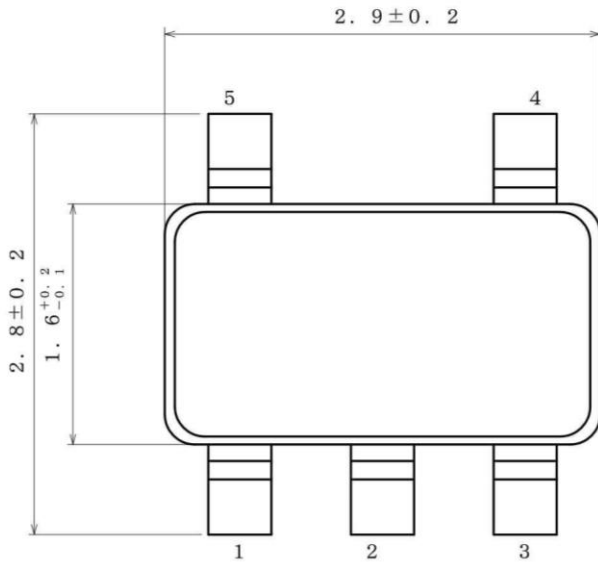

(UNIT : mm)

PKG : SSOP5

Drawing No. EX106-5001-2

< Tape and Reel Information >

Tape	Embossed carrier tape
Quantity	3000pcs
Direction of feed	TR (The direction is the 1 pin of product is at the upper right when you hold reel on the left hand and you pull out the tape on the right hand)

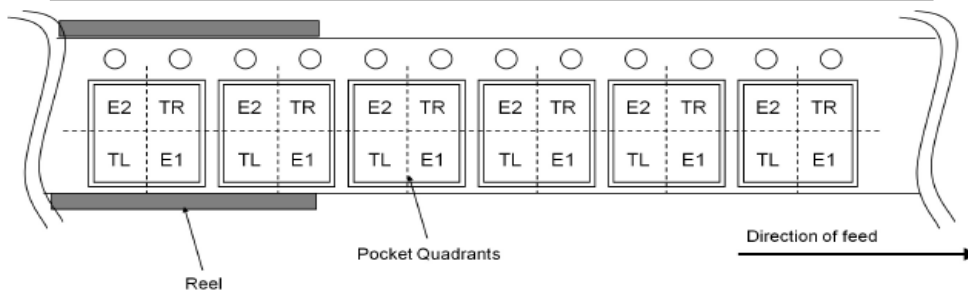

Revision History

Date	Revision	Changes
29.May.2018	001	New Release

Notice

Precaution on using ROHM Products

- Our Products are designed and manufactured for application in ordinary electronic equipment (such as AV equipment, OA equipment, telecommunication equipment, home electronic appliances, amusement equipment, etc.). If you intend to use our Products in devices requiring extremely high reliability (such as medical equipment ^(Note 1), transport equipment, traffic equipment, aircraft/spacecraft, nuclear power controllers, fuel controllers, car equipment including car accessories, safety devices, etc.) and whose malfunction or failure may cause loss of human life, bodily injury or serious damage to property ("Specific Applications"), please consult with the ROHM sales representative in advance. Unless otherwise agreed in writing by ROHM in advance, ROHM shall not be in any way responsible or liable for any damages, expenses or losses incurred by you or third parties arising from the use of any ROHM's Products for Specific Applications.

(Note1) Medical Equipment Classification of the Specific Applications

JAPAN	USA	EU	CHINA
CLASS III	CLASS III	CLASS II b	CLASS III
CLASS IV		CLASS III	

- ROHM designs and manufactures its Products subject to strict quality control system. However, semiconductor products can fail or malfunction at a certain rate. Please be sure to implement, at your own responsibilities, adequate safety measures including but not limited to fail-safe design against the physical injury, damage to any property, which a failure or malfunction of our Products may cause. The following are examples of safety measures:
 - Installation of protection circuits or other protective devices to improve system safety
 - Installation of redundant circuits to reduce the impact of single or multiple circuit failure
- Our Products are designed and manufactured for use under standard conditions and not under any special or extraordinary environments or conditions, as exemplified below. Accordingly, ROHM shall not be in any way responsible or liable for any damages, expenses or losses arising from the use of any ROHM's Products under any special or extraordinary environments or conditions. If you intend to use our Products under any special or extraordinary environments or conditions (as exemplified below), your independent verification and confirmation of product performance, reliability, etc. prior to use, must be necessary:
 - Use of our Products in any types of liquid, including water, oils, chemicals, and organic solvents
 - Use of our Products outdoors or in places where the Products are exposed to direct sunlight or dust
 - Use of our Products in places where the Products are exposed to sea wind or corrosive gases, including Cl₂, H₂S, NH₃, SO₂, and NO₂
 - Use of our Products in places where the Products are exposed to static electricity or electromagnetic waves
 - Use of our Products in proximity to heat-producing components, plastic cords, or other flammable items
 - Sealing or coating our Products with resin or other coating materials
 - Use of our Products without cleaning residue of flux (even if you use no-clean type fluxes, cleaning residue of flux is recommended); or Washing our Products by using water or water-soluble cleaning agents for cleaning residue after soldering
 - Use of the Products in places subject to dew condensation
- The Products are not subject to radiation-proof design.
- Please verify and confirm characteristics of the final or mounted products in using the Products.
- In particular, if a transient load (a large amount of load applied in a short period of time, such as pulse. is applied, confirmation of performance characteristics after on-board mounting is strongly recommended. Avoid applying power exceeding normal rated power; exceeding the power rating under steady-state loading condition may negatively affect product performance and reliability.
- De-rate Power Dissipation depending on ambient temperature. When used in sealed area, confirm that it is the use in the range that does not exceed the maximum junction temperature.
- Confirm that operation temperature is within the specified range described in the product specification.
- ROHM shall not be in any way responsible or liable for failure induced under deviant condition from what is defined in this document.

Precaution for Mounting / Circuit board design

- When a highly active halogenous (chlorine, bromine, etc.) flux is used, the residue of flux may negatively affect product performance and reliability.
- In principle, the reflow soldering method must be used on a surface-mount products, the flow soldering method must be used on a through hole mount products. If the flow soldering method is preferred on a surface-mount products, please consult with the ROHM representative in advance.

For details, please refer to ROHM Mounting specification

Precautions Regarding Application Examples and External Circuits

1. If change is made to the constant of an external circuit, please allow a sufficient margin considering variations of the characteristics of the Products and external components, including transient characteristics, as well as static characteristics.
2. You agree that application notes, reference designs, and associated data and information contained in this document are presented only as guidance for Products use. Therefore, in case you use such information, you are solely responsible for it and you must exercise your own independent verification and judgment in the use of such information contained in this document. ROHM shall not be in any way responsible or liable for any damages, expenses or losses incurred by you or third parties arising from the use of such information.

Precaution for Electrostatic

This Product is electrostatic sensitive product, which may be damaged due to electrostatic discharge. Please take proper caution in your manufacturing process and storage so that voltage exceeding the Products maximum rating will not be applied to Products. Please take special care under dry condition (e.g. Grounding of human body / equipment / solder iron, isolation from charged objects, setting of Ionizer, friction prevention and temperature / humidity control).

Precaution for Storage / Transportation

1. Product performance and soldered connections may deteriorate if the Products are stored in the places where:
 - [a] the Products are exposed to sea winds or corrosive gases, including Cl₂, H₂S, NH₃, SO₂, and NO₂
 - [b] the temperature or humidity exceeds those recommended by ROHM
 - [c] the Products are exposed to direct sunshine or condensation
 - [d] the Products are exposed to high Electrostatic
2. Even under ROHM recommended storage condition, solderability of products out of recommended storage time period may be degraded. It is strongly recommended to confirm solderability before using Products of which storage time is exceeding the recommended storage time period.
3. Store / transport cartons in the correct direction, which is indicated on a carton with a symbol. Otherwise bent leads may occur due to excessive stress applied when dropping of a carton.
4. Use Products within the specified time after opening a humidity barrier bag. Baking is required before using Products of which storage time is exceeding the recommended storage time period.

Precaution for Product Label

A two-dimensional barcode printed on ROHM Products label is for ROHM's internal use only.

Precaution for Disposition

When disposing Products please dispose them properly using an authorized industry waste company.

Precaution for Foreign Exchange and Foreign Trade act

Since concerned goods might be fallen under listed items of export control prescribed by Foreign exchange and Foreign trade act, please consult with ROHM in case of export.

Precaution Regarding Intellectual Property Rights

1. All information and data including but not limited to application example contained in this document is for reference only. ROHM does not warrant that foregoing information or data will not infringe any intellectual property rights or any other rights of any third party regarding such information or data.
2. ROHM shall not have any obligations where the claims, actions or demands arising from the combination of the Products with other articles such as components, circuits, systems or external equipment (including software).
3. No license, expressly or implied, is granted hereby under any intellectual property rights or other rights of ROHM or any third parties with respect to the Products or the information contained in this document. Provided, however, that ROHM will not assert its intellectual property rights or other rights against you or your customers to the extent necessary to manufacture or sell products containing the Products, subject to the terms and conditions herein.

Other Precaution

1. This document may not be reprinted or reproduced, in whole or in part, without prior written consent of ROHM.
2. The Products may not be disassembled, converted, modified, reproduced or otherwise changed without prior written consent of ROHM.
3. In no event shall you use in any way whatsoever the Products and the related technical information contained in the Products or this document for any military purposes, including but not limited to, the development of mass-destruction weapons.
4. The proper names of companies or products described in this document are trademarks or registered trademarks of ROHM, its affiliated companies or third parties.

General Precaution

1. Before you use our Products, you are requested to carefully read this document and fully understand its contents. ROHM shall not be in any way responsible or liable for failure, malfunction or accident arising from the use of any ROHM's Products against warning, caution or note contained in this document.
2. All information contained in this document is current as of the issuing date and subject to change without any prior notice. Before purchasing or using ROHM's Products, please confirm the latest information with a ROHM sales representative.
3. The information contained in this document is provided on an "as is" basis and ROHM does not warrant that all information contained in this document is accurate and/or error-free. ROHM shall not be in any way responsible or liable for any damages, expenses or losses incurred by you or third parties resulting from inaccuracy or errors of or concerning such information.



BU6823G - Web Page

[Distribution Inventory](#)

Part Number	BU6823G
Package	SSOP5
Unit Quantity	3000
Minimum Package Quantity	3000
Packing Type	Taping
Constitution Materials List	inquiry
RoHS	Yes