

Features

- Ultra small package: 1.0x0.6x0.5mm
- Ultra low capacitance: 10pF max
- Ultra low leakage: nA level
- Low operating voltage: $\pm 5V$
- Low clamping voltage
- 2-pin leadless package
- Complies with following standards:
 - – IEC 61000-4-2 (ESD) immunity test
 - Air discharge: $\pm 30kV$
 - Contact discharge: $\pm 30kV$
 - – IEC61000-4-5 (Lightning) 7A (8/20 μs)
- RoHS Compliant

Mechanical Characteristics

- Package: DFN1006-2 (0402)
- Lead Finish: Matte Tin
- Case Material: "Green" Molding Compound.
- Moisture Sensitivity: Level 3 per J-STD-020
- Terminal Connections: See Diagram Below
- Shipping Qty : 12000pcs/7Inch Tape & Reel

Applications

- Smart Phone and Tablet PC
- TV and Set Top Box
- Wearable Devices
- PDA

Dimensions and Pin Configuration

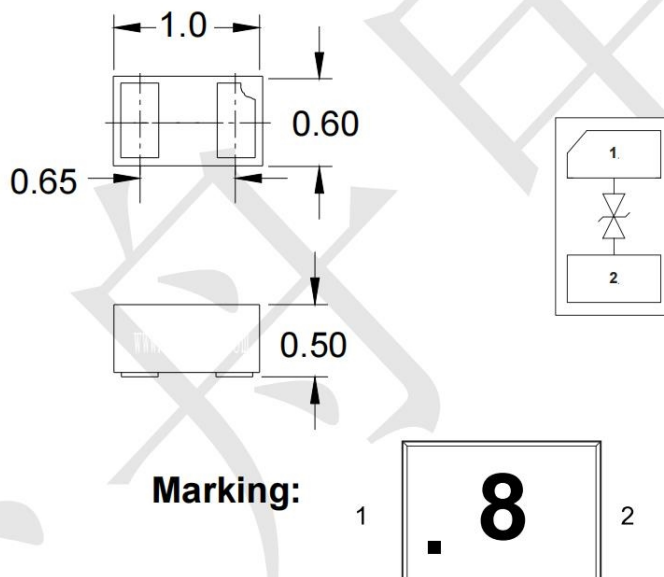

Absolute Maximum Ratings (Tamb=25°C unless otherwise specified)

Parameter	Symbol	Value	Unit
Peak Pulse Power (8/20μs)	Ppk	75	W
Peak Pulse Current (8/20μs)	Ipp	7	A
ESD per IEC 61000-4-2 (Air)	VESD	±30	kV
ESD per IEC 61000-4-2 (Contact)		±30	
Operating Temperature Range	TJ	-55 to +125	°C
Storage Temperature Range	Tstg	-55 to +150	°C

Symbol	Parameter
V_{RWM}	Nominal Reverse Working Voltage
I_R	Reverse Leakage Current @ V_{RWM}
V_{tl}	Trigger Voltage
I_{tl}	Trigger Current @ V_{tl}
V_h	Holding Voltage
I_h	Holding Current @ V_h
V_C	Clamping Voltage @ I_{pp}
I_{pp}	Maximum Peak Pulse Current
V_F	Forward Voltage @ I_F
C_{ESD}	Parasitic Capacitance

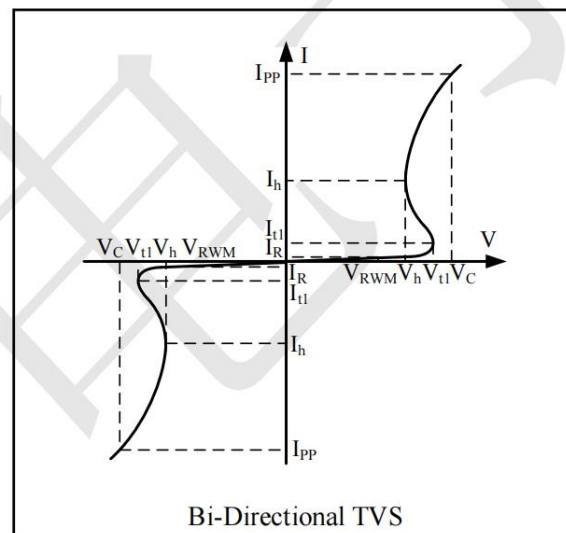

Electrical Characteristics (TA=25°C unless otherwise specified)

Parameter	Symbol	Min	Typ	Max	Unit	Test Condition
Reverse Working Voltage	V_{RWM}			5	V	
Breakdown Voltage	V_{BR}	5.6			V	$I_T = 1\text{mA}$
Reverse Holding Voltage	V_H	5.5			V	$I_H = 1\text{mA}$
Reverse Leakage Current	I_R			0.2	uA	$V_{RWM} = 5\text{V}$
Clamping Voltage	V_C			9	V	$I_{pp}=1\text{A}(8 \times 20\text{us pulse})$
Clamping Voltage	V_C		15	17	V	$I_{pp}=7\text{A}(8 \times 20\text{us pulse})$
Junction Capacitance	C_J		9	10	pF	$V_R = 0\text{V}$, $f = 1\text{MHz}$

Typical Performance Characteristics ($T_A=25^\circ\text{C}$ unless otherwise Specified)

Fig1. 8/20 μs Pulse Waveform

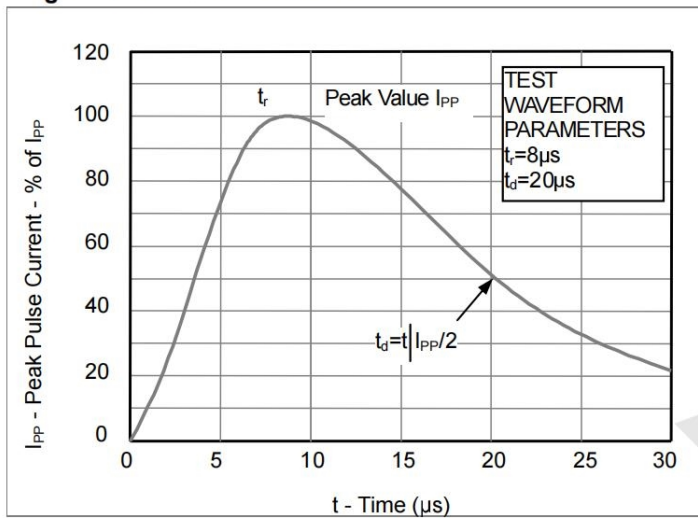

Fig2. ESD Pulse Waveform (according to IEC 61000-4-2)

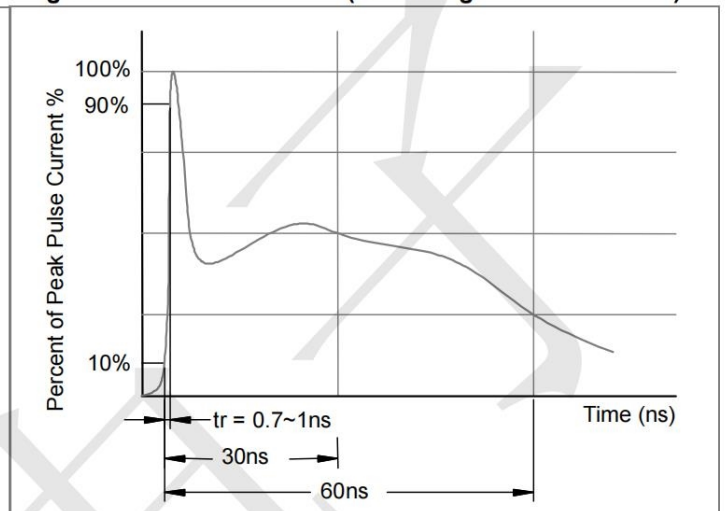
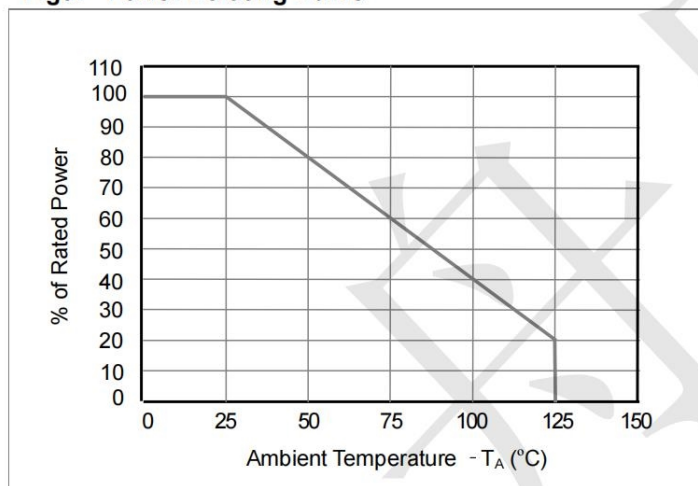
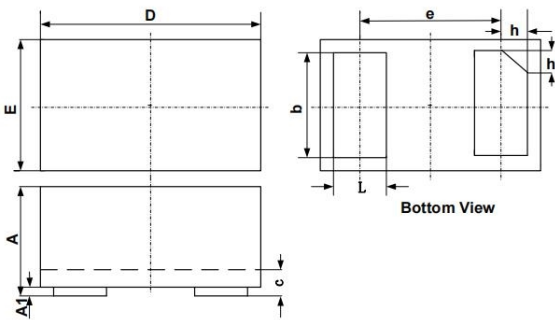

Fig3. Power Derating Curve



DFN1006-2 Package Outline Drawing (0402)



SYM	DIMENSIONS					
	MILLIMETERS			INCHES		
	MIN	NOM	MAX	MIN	NOM	MAX
A	0.45	0.50	0.55	0.018	0.020	0.022
A1	0.00	0.02	0.05	0.000	0.001	0.002
b	0.45	0.50	0.55	0.018	0.020	0.022
c	0.12	0.15	0.18	0.005	0.006	0.007
D	0.95	1.00	1.05	0.037	0.039	0.041
e	0.65 BSC			0.026 BSC		
E	0.55	0.60	0.65	0.022	0.024	0.026
L	0.20	0.25	0.30	0.008	0.010	0.012
h	0.07	0.12	0.17	0.003	0.005	0.007

Suggested Land Pattern

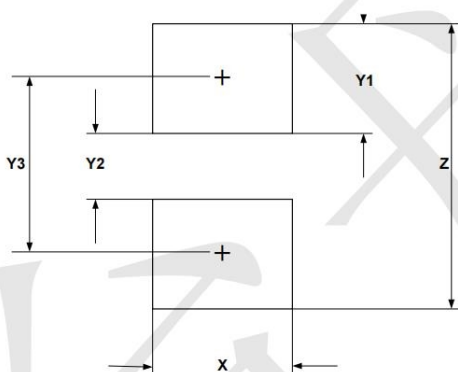

SYM	DIMENSIONS	
	MILLIMETERS	INCHES
X	0.60	0.024
Y1	0.50	0.020
Y2	0.30	0.012
Y3	0.80	0.032
Z	1.30	0.052