

### ZOE-30-ZOOM

Ø30 mm zoomable lens with infinitely adjustable beam from 13 to 42 degrees

#### TECHNICAL SPECIFICATIONS:

|                |           |
|----------------|-----------|
| Dimensions     | Ø 31.6 mm |
| Height         | 20.3 mm   |
| ROHS compliant | yes ⓘ     |



#### MATERIAL SPECIFICATIONS:

| Component              | Type        | Material | Colour | Finish |
|------------------------|-------------|----------|--------|--------|
| C17716_ZOE-30-ZOOM     | Single lens | PMMA     | clear  |        |
| C17717_ZOE-30-ZOOM-SUB | Sublens     | PC       | clear  |        |

#### ORDERING INFORMATION:

##### Quantities for one set:

|             |   |
|-------------|---|
| Single lens | 1 |
| Sublens     | 1 |

| Component                      |             | Qty in box | MOQ | MPQ | Box weight (kg) |
|--------------------------------|-------------|------------|-----|-----|-----------------|
| C17716_ZOE-30-ZOOM             | Single lens | 1560       | 104 | 104 | 12.1            |
| » Box size: 480 x 280 x 300 mm |             |            |     |     |                 |
| C17717_ZOE-30-ZOOM-SUB         | Sublens     | 1560       | 104 | 104 | 3.6             |
| » Box size: 480 x 280 x 115 mm |             |            |     |     |                 |

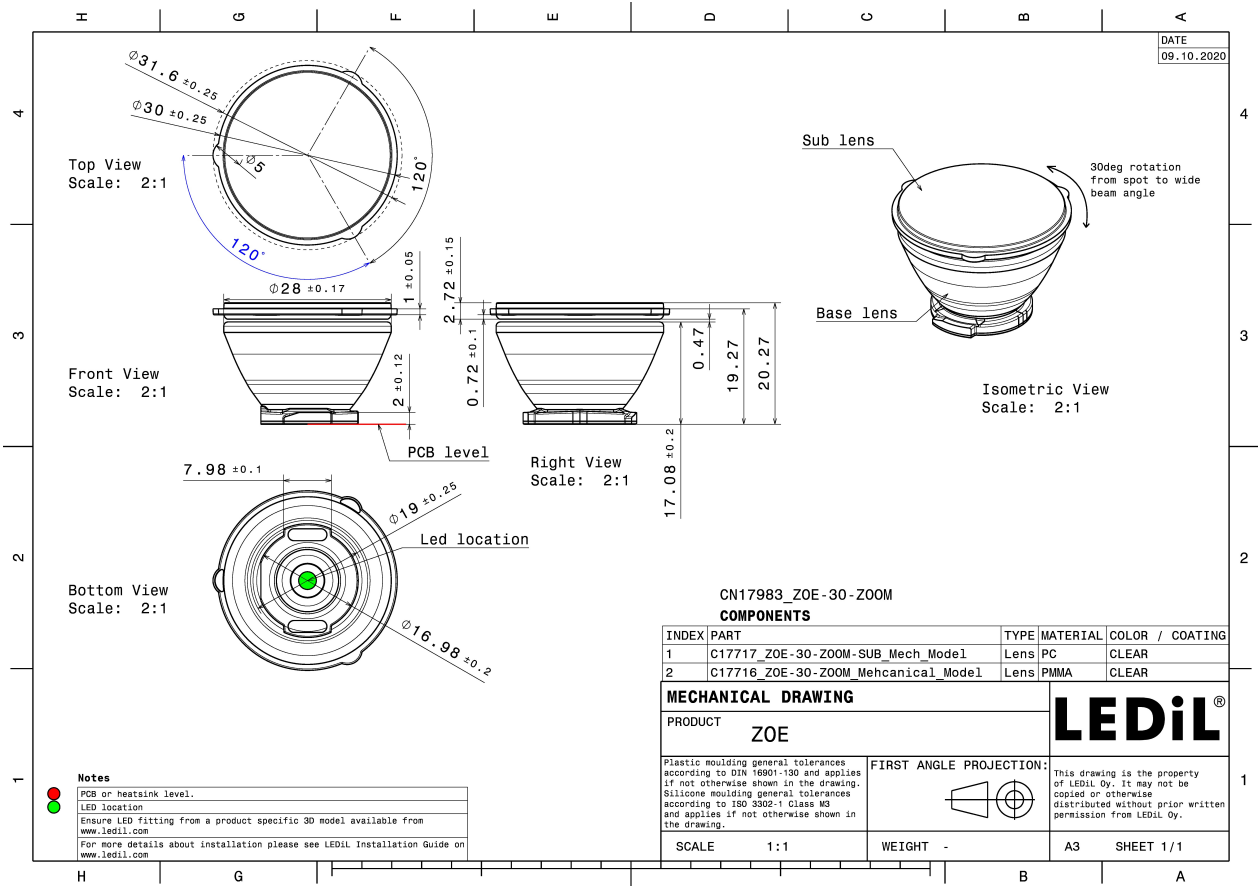

See also our general installation guide: [www.ledil.com/installation\\_guide](http://www.ledil.com/installation_guide)

### PHOTOMETRIC DATA (MEASURED):

#### CREE LED

LED XHP50.3 HI  
 FWHM / FWTM 16.0 + 43.0° / 34.0 + 67.0°  
 Efficiency 76 %  
 Peak intensity 5.9 cd/lm  
 LEDs/each optic 1  
 Light colour White  
 Required components:

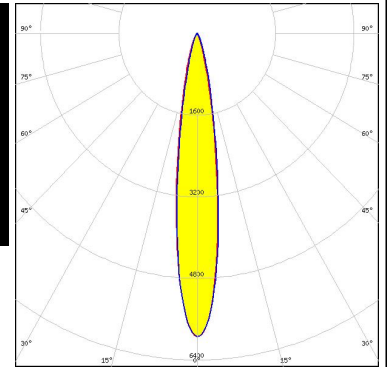

#### CREE LED

LED XM-L3  
 FWHM / FWTM 15.0 + 43.0° / 31.0 + 64.0°  
 Efficiency 78 %  
 Peak intensity 7.3 cd/lm  
 LEDs/each optic 1  
 Light colour White  
 Required components:

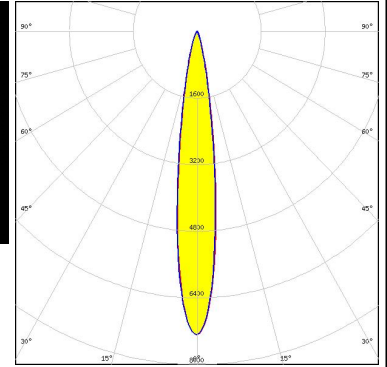
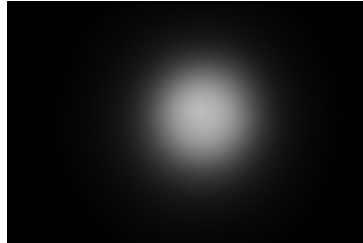

#### CREE LED

LED XP-L2  
 FWHM / FWTM 16.0 + 43.0° / 32.0 + 66.0°  
 Efficiency 75 %  
 Peak intensity 6.3 cd/lm  
 LEDs/each optic 1  
 Light colour White  
 Required components:

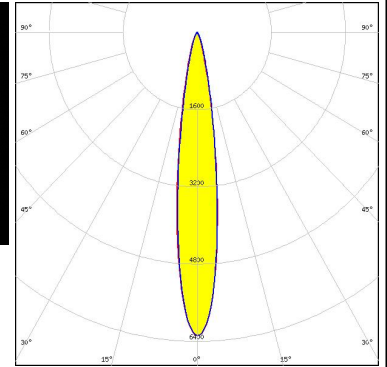





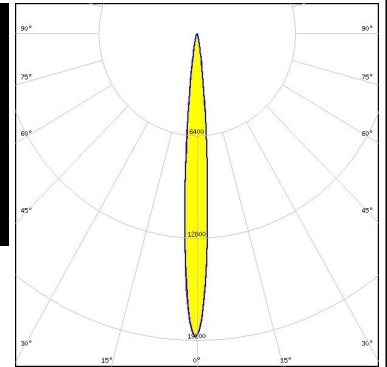

#### CREE LED

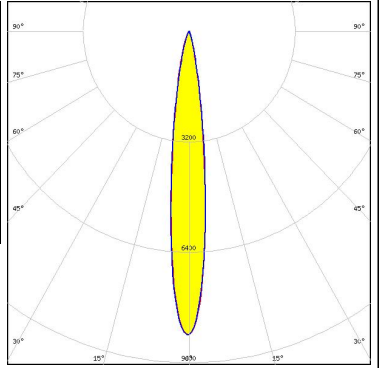

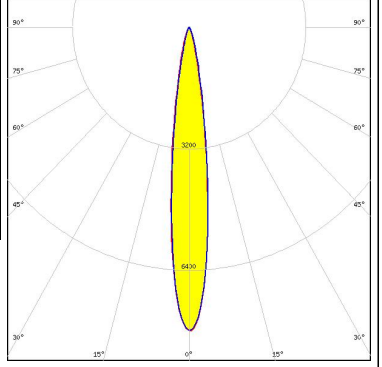

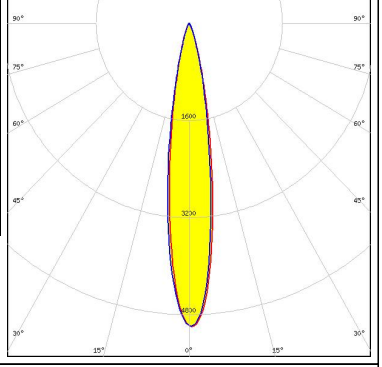
LED XP-P  
 FWHM / FWTM 9.0 + 40.0° / 19.0 + 57.0°  
 Efficiency 80 %  
 Peak intensity 19 cd/lm  
 LEDs/each optic 1  
 Light colour White  
 Required components:

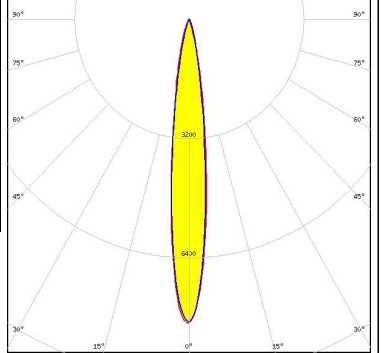

### PHOTOMETRIC DATA (MEASURED):

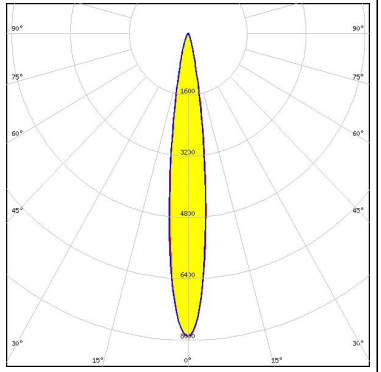
|  |  |   |
|--|--|---|
| <p><b>LUMILEDS</b></p> <p>LED LUXEON HL2X<br/>           FWHM / FWTM 14.0 + 42.0° / 29.0 + 61.0°<br/>           Efficiency 80 %<br/>           Peak intensity 8.8 cd/lm<br/>           LEDs/each optic 1<br/>           Light colour White<br/>           Required components:</p> |    |    |
| <p><b>NICHIA</b></p> <p>LED NVSW319B<br/>           FWHM / FWTM 14.0 + 43.0° / 30.0 + 64.0°<br/>           Efficiency 80 %<br/>           Peak intensity 8 cd/lm<br/>           LEDs/each optic 1<br/>           Light colour White<br/>           Required components:</p>        |   |   |
| <p><b>NICHIA</b></p> <p>LED NVSW519A<br/>           FWHM / FWTM 17.0 + 43.0° / 35.0 + 65.0°<br/>           Efficiency 68 %<br/>           Peak intensity 5 cd/lm<br/>           LEDs/each optic 1<br/>           Light colour White<br/>           Required components:</p>        |  |  |
| <p><b>NICHIA</b></p> <p>LED NVSxE21A<br/>           FWHM / FWTM 14.0 + 41.0° / 29.0 + 63.0°<br/>           Efficiency 76 %<br/>           Peak intensity 8.1 cd/lm<br/>           LEDs/each optic 1<br/>           Light colour White<br/>           Required components:</p>      |  |  |

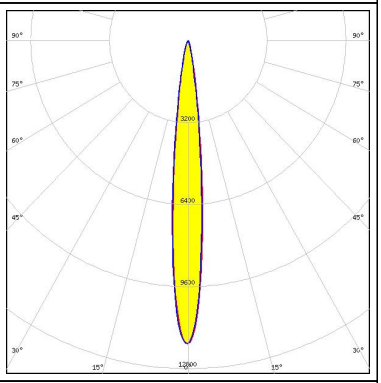
### PHOTOMETRIC DATA (MEASURED):

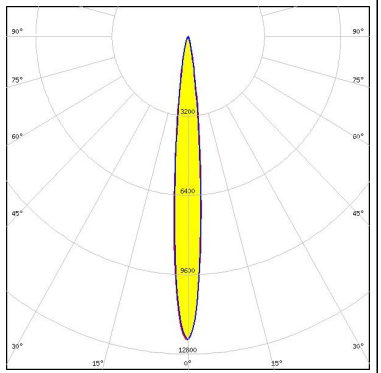
|   |  |   |
|---|--|---|
| <p><b>OSRAM</b><br/>Opto Semiconductors</p> <p>LED OSCONIQ P 3737 (3W version)</p> <p>FWHM / FWTM 14.0 + 42.0° / 30.0 + 63.0°</p> <p>Efficiency 78 %</p> <p>Peak intensity 7.9 cd/lm</p> <p>LEDs/each optic 1</p> <p>Light colour White</p> <p>Required components:</p> |    |    |
| <p><b>OSRAM</b><br/>Opto Semiconductors</p> <p>LED OSLON Square CSSRM2/CSSRM3</p> <p>FWHM / FWTM 12.0 + 41.0° / 24.0 + 60.0°</p> <p>Efficiency 78 %</p> <p>Peak intensity 11.8 cd/lm</p> <p>LEDs/each optic 1</p> <p>Light colour White</p> <p>Required components:</p> |   |   |
| <p><b>OSRAM</b><br/>Opto Semiconductors</p> <p>LED OSLON Square Flat</p> <p>FWHM / FWTM 10.0 + 41.0° / 23.0 + 61.0°</p> <p>Efficiency 75 %</p> <p>Peak intensity 12.2 cd/lm</p> <p>LEDs/each optic 1</p> <p>Light colour White</p> <p>Required components:</p>          |  |  |

### PHOTOMETRIC DATA (SIMULATED):



**LED** XHP35 HD  
**FWHM / FWTM** 18.0 + 40.0° / 37.0 + 67.0°  
**Efficiency** 80 %  
**Peak intensity** 5.5 cd/lm  
**LEDs/each optic** 1  
**Light colour** White  
**Required components:**

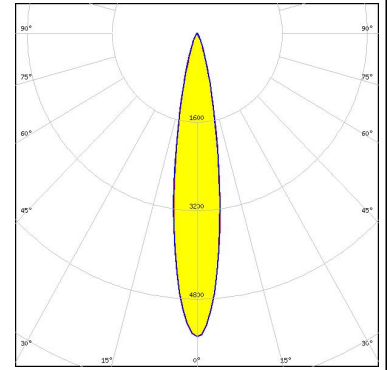

**LED** XP-L HI  
**FWHM / FWTM** 12.0 + 40.0° / 26.0 + 63.0°  
**Efficiency** 84 %  
**Peak intensity** 11.4 cd/lm  
**LEDs/each optic** 1  
**Light colour** White  
**Required components:**

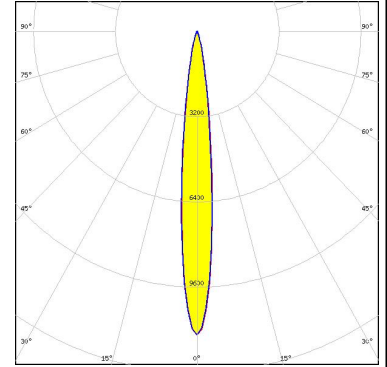

**LED** SST-40  
**FWHM / FWTM** 16.0 + 40.0° / 34.0 + 66.0°  
**Efficiency** 90 %  
**Peak intensity** 6.8 cd/lm  
**LEDs/each optic** 1  
**Light colour** White  
**Required components:**

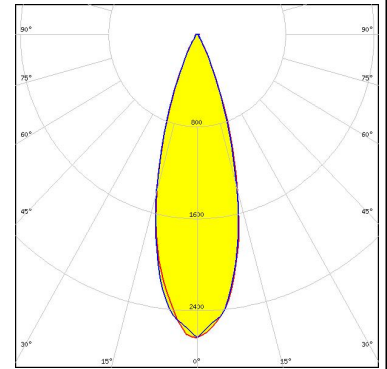

### GENERAL INFORMATION:

NOTE: The typical beam angle will be changed by different color, chip size and chip position tolerance. The typical total beam angle is the full angle measured where the luminous intensity is half of the peak value.

### MATERIALS:

As part of our continuous research and improvement processes, and to ensure the best possible quality and availability of our products, LEDiL reserves the right to change material grades without notice.

### PRODUCT DATA USER AGREEMENT AND DISCLAIMER:

The measured data in the provided downloadable LEDiL Product Datasheets and Mechanical 2D-Drawings is rounded and provided as reference for planning. LEDiL Oy's optical specifications have been verified by conducting performance testing of the products in accordance with the company's quality system. The reported data are averaged results of multiple measurements with typical variation. LEDiL Oy reserves the right to without prior notification make changes and improvements to its products.

LEDiL Oy assumes neither warranty, nor guarantee nor any other liability of any kind for the contents and correctness of the provided data. The provided data has been generated with highest diligence but the provided data may in reality not represent the complete possible variation range of all intrinsic parameters. Therefore, in certain cases a deviation from the provided data could occur.

LEDiL Oy reserves the right to undertake technical changes of its products without further notification which could lead to changes in the provided data. LEDiL Oy assumes no liability of any kind for the possible deviation from any provided data or any other damage resulting from the usage of the provided data.

The user agrees to this disclaimer and user agreement with the download or usage of the provided files.

#### LEDiL Oy

Joensuunkatu 13  
FI-24240 SALO  
Finland

#### LEDiL Inc.

228 West Page Street  
Suite D  
Sycamore IL 60178  
USA

#### Ledil Optics Technology (Shenzhen) Co., Ltd.

# 405 , Block B  
Casic Motor Building  
Shenzhen 518057  
P.R.CHINA

#### Local sales and technical support

[www.ledil.com/  
where\\_to\\_buy](http://www.ledil.com/where_to_buy)

#### Shipping locations

Salo, Finland  
Hong Kong, China

#### Distribution Partners

[www.ledil.com/  
where\\_to\\_buy](http://www.ledil.com/where_to_buy)