



## Features

- ◆ Transient protection for high speed data lines to IEC 61000-4-2 (ESD)  $\pm 30\text{kV}$  (air),  $\pm 30\text{kV}$  (contact)  
IEC 61000-4-4 (EFT) 40A (5/50ns)
- ◆ Protects one bidirectional line or
- ◆ Low operating and clamping voltages
- ◆ Solid-state silicon avalanche technology

## Ordering Information

Part Number	Qty per Reel	Reel Size
ESDA6V1L	3000	7"

## Mechanical Characteristics

- ◆ Package: SOT23
- ◆ Lead Finish: Matte Tin
- ◆ UL Flammability Classification Rating 94V-0
- ◆ Pb-Free, Halogen Free, RoHS/WEEE Compliant

## Applications

- ◆ USB Power & Data Line Protection
- ◆ Monitors and Flat Panel Displays
- ◆ I<sup>2</sup>C Bus Protection
- ◆ Portable Instrumentation
- ◆ Set Top Box

## Dimensions and Pin Configuration

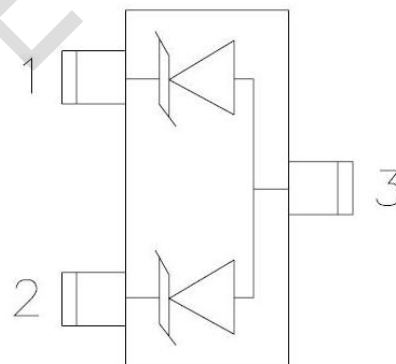

Circuit and Pin Schematic



**Absolute Maximum Ratings** (Tamb=25°C unless otherwise specified)

Parameter	Symbol	Value	Unit
Peak Pulse Current (8/20μs)	Ipp	6	A
ESD per IEC 61000-4-2 (Air)	VESD	±30	kV
ESD per IEC 61000-4-2 (Contact)		±30	
Operating Temperature Range	TJ	-55 to +125	°C
Storage Temperature Range	Tstg	-55 to +150	°C

**Electrical Characteristics** (TA=25°C unless otherwise specified)

Type	IR(uA) Vrwm	VBR(V)IT		It	VC(V) Max Ipp	Ipp(A)	C(pf)
	Max	Min	Max	mA	Max	Max	Max
ESDA6V1L	1.0	6.2	6.9	1.0	17.2	6.2	55



**Typical Performance Characteristics ( $T_A=25^\circ\text{C}$  unless otherwise Specified)**

Fig1. 8/20 $\mu\text{s}$  Pulse Waveform

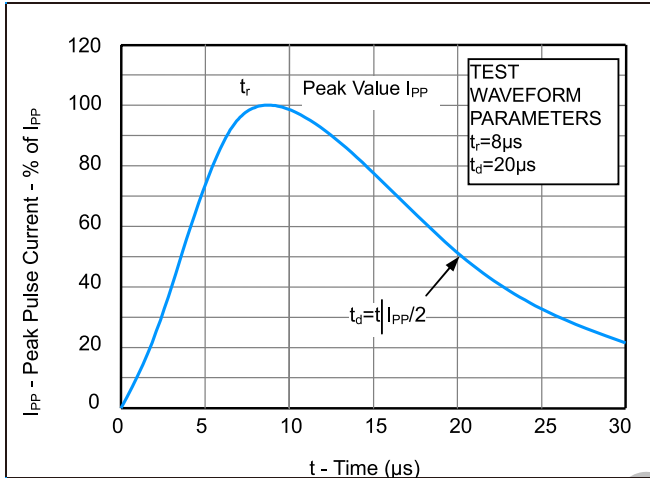

Fig2. ESD Pulse Waveform (according to IEC 61000-4-2)

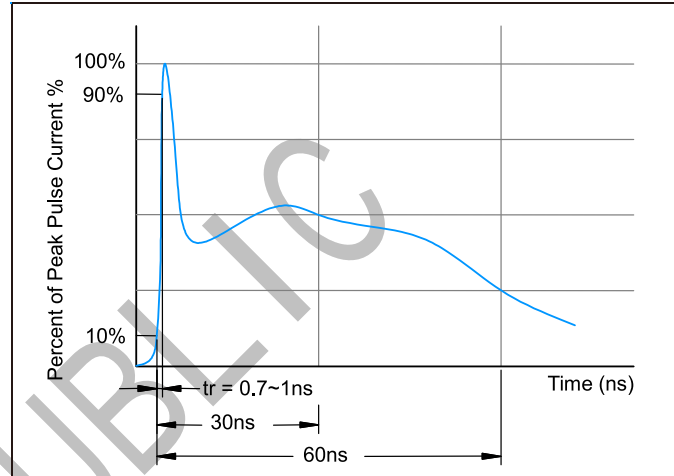

Fig3. Power Derating Curve

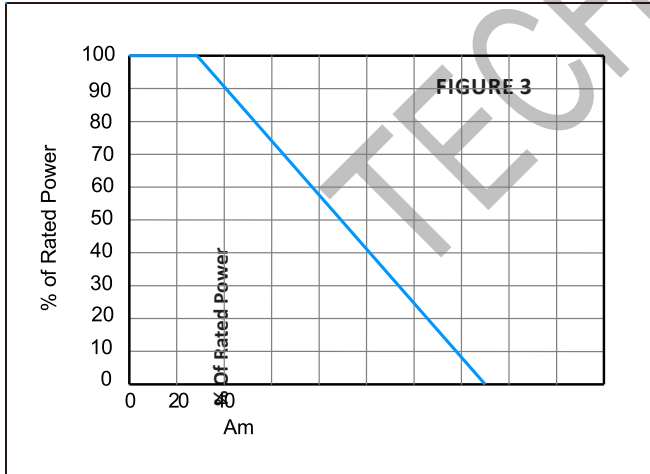
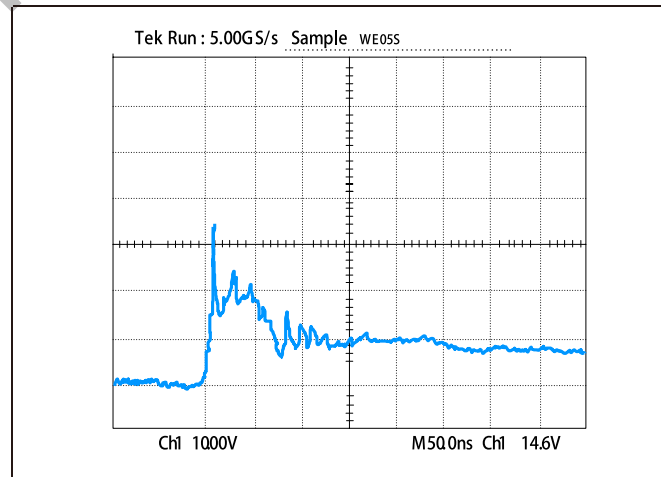
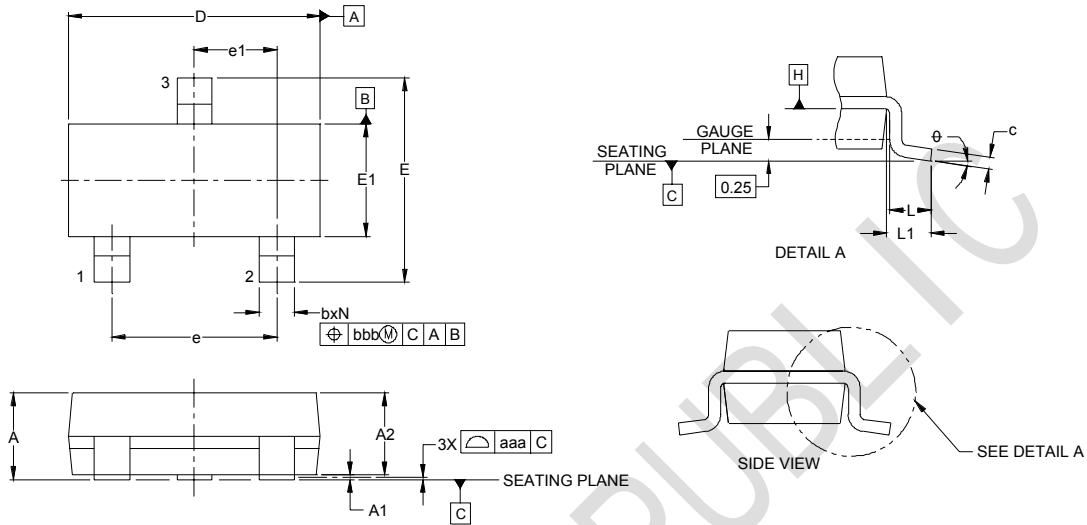

Figure 4: ESD Clamping (8kV Contact per IEC 61000-4-2)





## Outline Drawing - SOT23



DIM	INCHES			MILLIMETERS		
	MIN	NOM	MAX	MIN	NOM	MAX
A	.035	-	.044	0.89	-	1.12
A1	.000	-	.004	0.01	-	0.10
A2	.035	.037	.040	0.88	0.95	1.02
b	.012	-	.020	0.30	-	0.51
c	.003	-	.007	0.08	-	0.18
D	.110	.114	.120	2.80	2.90	3.04
E	.082	.093	.104	2.10	2.37	2.64
E1	.047	.051	.055	1.20	1.30	1.40
e	.075	-	-	1.90	BSC	-
e1	.037	-	-	0.95	BSC	-
L	.015	.020	.024	0.40	0.50	0.60
L1	.022	-	-	(0.55)	-	-
N	3	-	-	3	-	-
$\phi$	0°	-	8°	0°	-	8°
aaa	.004	-	-	0.10	-	-
bbb	.008	-	-	0.20	-	-

## Land Pattern - SOT23

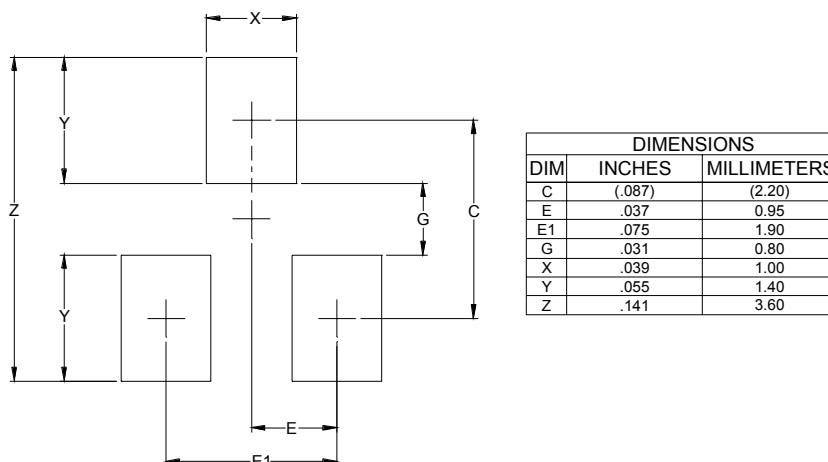

DIM	DIMENSIONS	
	INCHES	MILLIMETERS
C	(.087)	(2.20)
E	.037	0.95
E1	.075	1.90
G	.031	0.80
X	.039	1.00
Y	.055	1.40
Z	.141	3.60