

# Compact Guide Cylinder

Ø 12, Ø 16, Ø 20, Ø 25, Ø 32, Ø 40, Ø 50, Ø 63, Ø 80, Ø 100

Up to

**24 %**  
Weight  
reduced!

Weight reduced by up to 24 % with  
a shorter guide rod and thinner plate



**3 types of bearing**  
can be selected.

● **Slide bearing**

Series MGPM

● **Ball bushing**

Series MGPL

● **High precision ball bushing**

Series MGPA

**New**

- Cylinder with stable lubrication function (Lube-retainer) and Guide unit with Lube-retainer added.
- Made to Order: Shock absorber soft type series RJ type (-XB22) and Spatter resistant specification (-XC88, 89, 91) added.

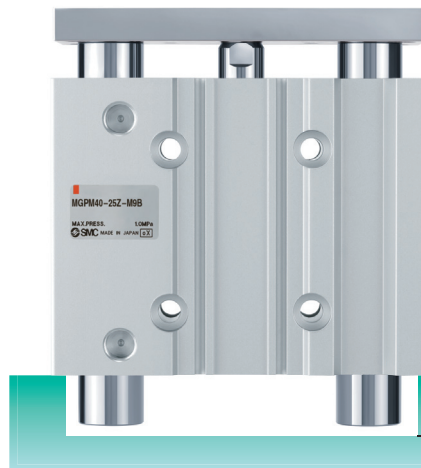

Guide rod shortened  
for MGPM40-25 stroke

Max. **22 mm**

Space required between the  
bottom of the cylinder body and  
your equipment is reduced.

Space saving



With air cushion

Water resistant cylinder

**Series MGP**



CAT.EUS20-219Dd-UK

### 3 types of bearing can be selected.

**Slide bearing**  
**Series MGPM**

Suitable for lateral load applications such as a stopper where shock is applied

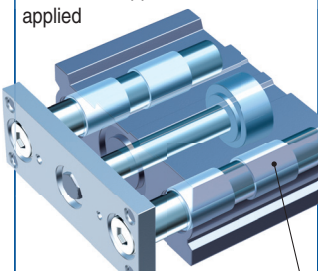

Slide bearing

**Ball bushing**  
**Series MGPL**

Smooth operation suitable for pusher and lifter

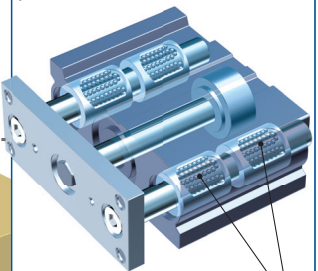

Ball bushing

**High precision ball bushing**  
**Series MGPA**

Suitable for minimizing plate displacement

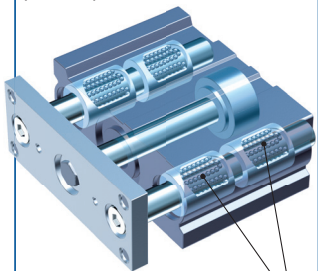

High precision ball bushing

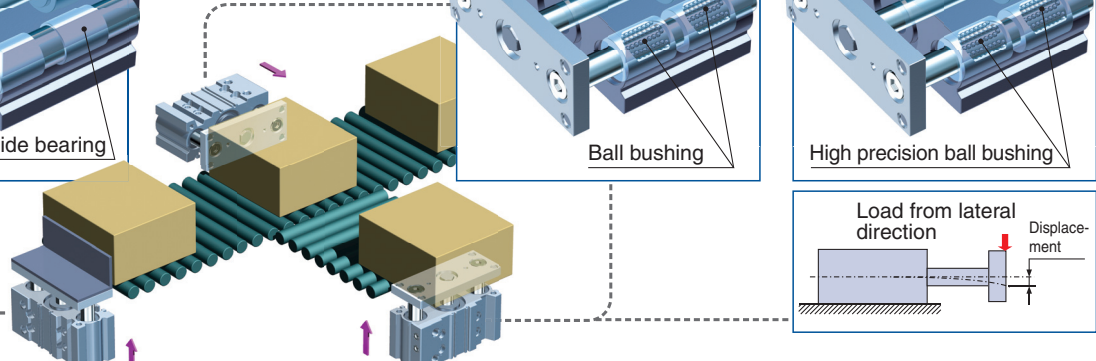

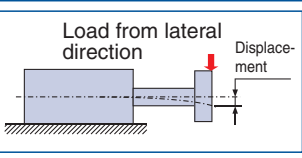

Load from lateral direction      Displacement

## Basic Type

- Weight reduced by up to **17 %**
- Guide rod shortened

Bore size [mm]	Reduction rate [%]	Weight [kg]
Ø 12	11	0.25
Ø 16	3	0.37
Ø 20	12	0.59
Ø 25	12	0.84
Ø 32	17	1.41
Ø 40	16	1.64
Ø 50	17	2.79
Ø 63	17	3.48
Ø 80	17	5.41
Ø 100	13	9.12

\*: Compared with the slide bearing type, Ø 12 to Ø 25-20 stroke  
 \*: Compared with the slide bearing type, Ø 32 to Ø 100-25 stroke

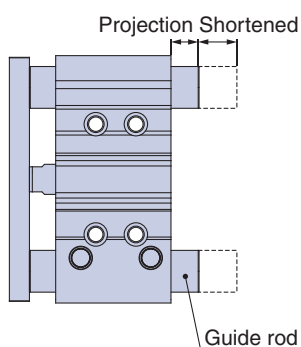

Bore size	Guide rod [mm]	
	Shortened by	New dimension
Ø 32	22	15.5
Ø 40	22	9
Ø 50	18	16.5
Ø 63	18	11.5
Ø 80	10.5	8
Ø 100	10.5	10.5

\*: Compared with the slide bearing type, 25 stroke (Ø 32 to Ø 100)  
 (No projection for Ø 12 to Ø 25-25 stroke)

- Performance and strength (rigidity) are equivalent to the current MGP series.
- Mounting dimensions are equivalent to the current MGP series.

### Series MGP (Basic Type), Stroke Variations

Bearing type	Bore size [mm]	Stroke [mm]																Made to Order
		10	20	25	30	40	50	75	100	125	150	175	200	250	300	350	400	
MGPM Slide bearing	12	●	●															-XA□: Change of guide rod end shape -XB6: Heat resistant cylinder (-10 to 150 °C) -XB10: Intermediate stroke (Using exclusive body) -XB13: Low speed cylinder (5 to 50 mm/s) -XC6: Made of stainless steel -XC8: Adjustable stroke cylinder/ Adjustable extension type -XC22: Fluororubber seal -XC35: With coil scraper -XC79: Tapped hole, drilled hole and pinned hole machined additionally -XC82: Bottom mounting type -X144: Symmetrical port position -X867: Side porting type (Plug location changed)
	16	●	●															
	20	●	●	●														
MGPL Ball bushing	25		●	●														
	32			●	●													
	40				●	●												
MGPA High precision ball bushing	50				●	●												
	63					●	●											
	80						●	●										
	100							●	●									

\*: For details, refer to pages 69 to 89.

Small auto switches or magnetic field resistant auto switches can be directly mounted on **2 surfaces**.

**D-M9** **D-A9** **D-P3DWA**

\*: The D-Y7 and D-Z7 auto switches are not mountable.

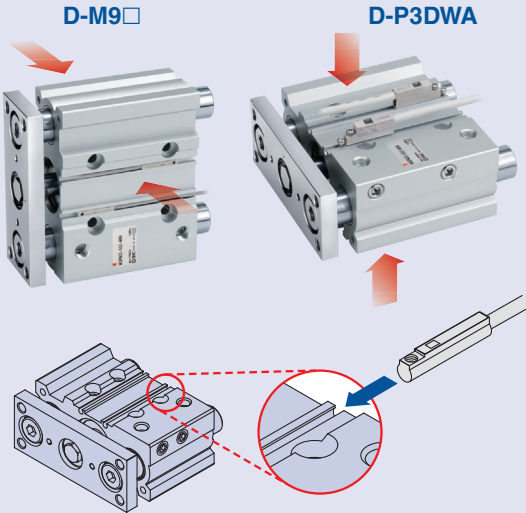

**4 types of mounting are possible.**

Easy positioning  
Knock pin holes provided on each mounting surface

**1. Top mounting**

**2. Bottom mounting**

**3. T-slot bottom mounting**

Easy adjustment of workpiece and cylinder mounting

**4. Bottom mounting**

**Piping is possible from 2 directions.**

**1. Top ported**

**2. Side ported**

## With Air Cushion

Weight reduced by up to **24 %**    Guide rod shortened by up to **35.5 mm** (MGPM100-50 stroke) [mm]

Bore size [mm]	Reduction rate [%]	Weight [kg]
Ø 16	12	1.28
Ø 20	18	1.91
Ø 25	22	2.52
Ø 32	24	3.57
Ø 40	23	4.13
Ø 50	23	6.56
Ø 63	22	8.04
Ø 80	21	11.35
Ø 100	19	17.72

\*: Compared with the current MGPM with air cushion, 200 stroke

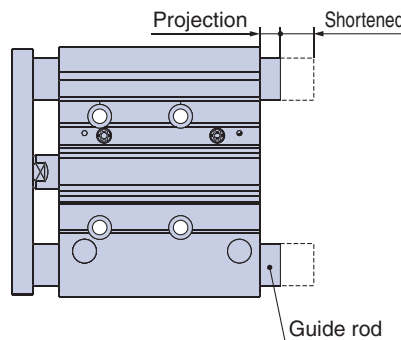

Bore size	Guide rod	
	Shortened by	New dimension
Ø 32	33.5	9
Ø 40	33.5	2.5
Ø 50	22	12.5
Ø 63	22	7.5
Ø 80	35.5	10
Ø 100	35.5	10.5

\*: Compared with the current MGPM with air cushion, 50 stroke

Performance and strength are equivalent to the current MGP series with air cushion.

Mounting dimensions are equivalent to the current MGP series with air cushion.

## Series MGP (With Air Cushion), Stroke Variations

Bearing type	Bore size [mm]	Stroke [mm]											Made to Order		
		25	50	75	100	125	150	175	200	250	300	350		400	
MGPM-□A Slide bearing	16	●	●	●	●	●	●	●	●	●	●	●	●	●	<p>-XC19: Intermediate stroke (Spacer type)</p> <p>-XC79: Tapped hole, drilled hole, pinned hole machined additionally</p> <p>-X867: Side porting type (Plug location changed)</p>
	20	●	●	●	●	●	●	●	●	●	●	●	●	●	
	25	●	●	●	●	●	●	●	●	●	●	●	●	●	
MGPL-□A Ball bushing	32	●	●	●	●	●	●	●	●	●	●	●	●	●	
	40	●	●	●	●	●	●	●	●	●	●	●	●	●	
	50	●	●	●	●	●	●	●	●	●	●	●	●	●	
MGPA-□A High precision ball bushing	63	●	●	●	●	●	●	●	●	●	●	●	●	●	
	80	●	●	●	●	●	●	●	●	●	●	●	●	●	
	100	●	●	●	●	●	●	●	●	●	●	●	●	●	
	100	●	●	●	●	●	●	●	●	●	●	●	●	●	

\*: For details, refer to pages 69 to 89.

## With End Lock

- Holds the cylinder's home position even if the air supply is cut off.
- Compact body  $\varnothing 20$  to  $\varnothing 63$  ..... Standard + 25 mm body length  
 $\varnothing 80, \varnothing 100$  ..... Standard + 50 mm body length

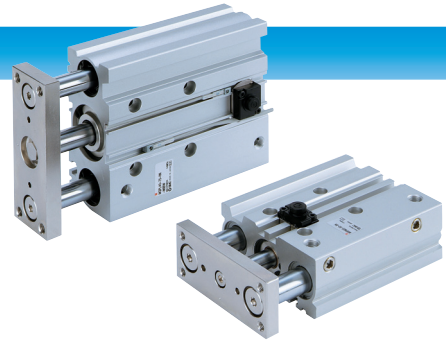

### Stroke Variations

Bearing type	Bore size [mm]	Stroke [mm]												Intermediate stroke	Lock direction	Manual release
		25	50	75	100	125	150	175	200	250	300	350	400			
<b>MGPM</b> Slide bearing	20	●	●	●	●	●	●	●	●	●	●	●	●	Spacer type available in 5 mm stroke increments.	Rod end lock	Non-lock type
	25	●	●	●	●	●	●	●	●	●	●	●	●			
<b>MGPL</b> Ball bushing bearing	32	●	●	●	●	●	●	●	●	●	●	●	●			
	40	●	●	●	●	●	●	●	●	●	●	●	●			
<b>MGPA</b> High precision ball bushing	50	●	●	●	●	●	●	●	●	●	●	●	●			
	63	●	●	●	●	●	●	●	●	●	●	●	●			
	80	●	●	●	●	●	●	●	●	●	●	●	●			
	100	●	●	●	●	●	●	●	●	●	●	●	●			
														Head end lock	Lock type	

## Heavy duty guide rod type with improved load resistance

### Stroke Variations

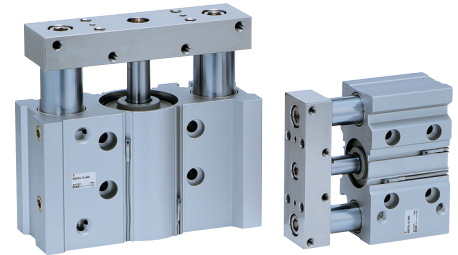

Bearing type	Bore size [mm]	Stroke [mm]							
		25	50	75	100	125	150	175	200
<b>MGPS</b> Slide bearing	50	●	●	●	●	●	●	●	●
	80	●	●	●	●	●	●	●	●



- Anti-lateral load : 10 % increase
- Eccentric load resistance: 25 % increase
- Impact load resistance : 140 % increase  
(Compared with MGPM50 compact guide cylinder)

Bore size [mm]	Guide rod diameter [mm]	
	MGPS	MGPM
<b>50</b>	30	25
<b>80</b>	45	30

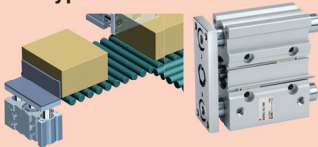
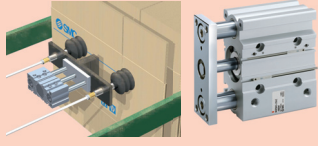
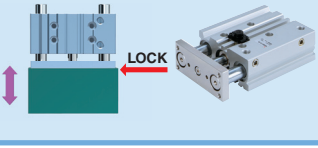
## Compact Guide Cylinders, Series Variations

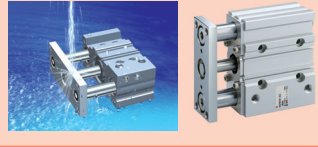
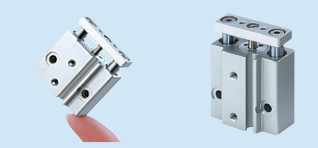
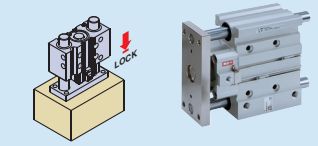
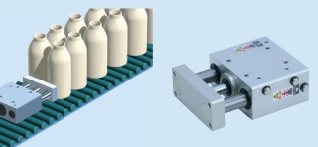
Series	Bearing type	Bore size										Page			
		6	10	12	16	20	25	32	40	50	63		80	100	
<b>Basic type/MGP-Z</b> 	Slide bearing			●	●	●	●	●	●	●	●	●	●		Page 9
	Ball bushing														
<b>With air cushion/MGP-AZ</b> 	High precision ball bushing				●	●	●	●	●	●	●	●	●		Page 29
<b>With end lock/MGP-H/R</b> 	Slide bearing														Page 46
	Ball bushing					●	●	●	●	●	●	●	●		
	High precision ball bushing														
<b>Heavy duty guide rod/MGPS</b> 	Slide bearing									●		●		Page 55	
<b>Clean series/12/13-MGP-Z</b> 	Ball bushing			●	●	●	●	●	●	●	●	●		Page 12	
<b>Water resistant cylinder/MGP R/V-Z</b> 	Slide bearing					●	●	●	●	●	●	●	●		Page 12
<b>Miniature Guide Rod Cylinder/MGJ</b> 	Slide bearing	●	●												Page 12
<b>Compact Guide Cylinder with Lock/MLGP</b> 	Slide bearing					●	●	●	●	●	●	●	●		Page 12
	Ball bushing														
<b>Hygienic Design Cylinder/HYG</b> 	Slide bearing					●	●	●	●	●	●				Page 12

\*: For details about the clean series, refer to the catalogues on [www.smc.eu](http://www.smc.eu).

# Combinations of Standard and Made to Order Specifications

## Series MGP

● : Standard
◎ : Made to Order
○ : Special product (Please contact SMC for details.)
— : Not available

Type	Basic type		
Bearing type	Slide bearing	Ball bushing	High precision ball bushing
Model	MGPM	MGPL	MGPA
Page	9		

Symbol	Specifications	Applicable bore size	Ø 12 to Ø 100		
Standard	Basic type		●	●	●
12-, 13-	Clean series	Ø 12 to Ø 63	—	●	—
25A-	Copper (Cu) and Zinc (Zn)-free *1	Ø 12 to Ø 100	●	●	○
20-	Copper and Fluorine-free *1		●	●*3	●*3
R/V	Water resistant	Ø 20 to Ø 100	●	—	—
MGP□M	Cylinder with stable lubrication function (Lube-retainer)		●	●	○
MGPM□G	Guide unit with Lube-retainer		●	—	—
MGP□F	With flange		●*5	●	●
-XA□	Change of guide rod end shape	Ø 12 to Ø 100	◎	◎	◎
-XB6	Heat resistant cylinder (-10 to 150 °C) *2		◎	—	—
-XB10	Intermediate stroke (Using exclusive body)	Ø 12 to Ø 100	◎	◎	◎
-XB13	Low speed cylinder (5 to 50 mm/s)		◎	◎	○
-XB22	Shock absorber soft type series RJ type	Ø 12 to Ø 40	◎	◎	◎
-XC4	With heavy duty scraper	Ø 20 to Ø 100	◎	◎	◎
-XC6	Made of stainless steel	Ø 12 to Ø 100	◎	◎	—
-XC8	Adjustable stroke cylinder/Adjustable extension type		◎	◎	◎
-XC9	Adjustable stroke cylinder/Adjustable retraction type *2		◎	◎	◎
-XC19	Intermediate stroke (Spacer type)	Ø 16 to Ø 100	—	—	—
-XC22	Fluororubber seal *2	Ø 12 to Ø 100	◎	—	—
-XC35	With coil scraper	Ø 20 to Ø 100	◎	◎	◎
-XC69	With shock absorber *4	Ø 12 to Ø 100	◎	◎	—
-XC79	Tapped hole, drilled hole, pinned hole machined additionally	Ø 12 to Ø 100	◎	◎	◎
-XC82	Bottom mounting type		◎	—	—
-XC85	Grease for food processing equipment		◎	◎	◎
-XC88	Spatter resistant coil scraper, Lube-retainer, Grease for welding (Rod parts: Stainless steel 304)	Ø 32 to Ø 100	◎	○	○
-XC89W	Spatter resistant coil scraper, Lube-retainer, Grease for welding (Rod parts: S45C)		◎	○	○
-XC91	Spatter resistant coil scraper, Grease for welding (Rod parts: S45C)		◎	○	○
-XC92	Dust resistant actuator *4	Ø 12 to Ø 100	◎	○	—
-X144	Symmetrical port position		◎	◎	◎
-X471	Enlarged plate and body gap dimensions	Ø 12 to Ø 63	◎	○	○
-X867	Side porting type (Plug location changed)	Ø 12 to Ø 100	◎	◎	◎

\*1: For details, refer to the catalogues on [www.smc.eu](http://www.smc.eu).

\*2: Without cushion

\*3: Copper and fluorine-free are available as standard products.

\*4: The shape is the same as the current product.

\*5: This product cannot be used as a stopper.

	With air cushion			With end lock *4			Heavy duty guide *4 rod type	Symbol
	Slide bearing	Ball bushing	High precision ball bushing	Slide bearing	Ball bushing	High precision ball bushing	Slide bearing	
	MGPM	MGPL	MGPA	MGPM	MGPL	MGPA	MGPS	
	29			46			55	
	Ø 16 to Ø 100			Ø 20 to Ø 100		Ø 20 to Ø 100	Ø 50, Ø 80	
	●	●	●	—	—	—	●	Standard
	—	—	—	—	○	—	—	12-, 13-
	○	○	○	○	○	○	○	25A-
	●	●*3	●*3	○	○	○	○	20-
	○	—	—	○	—	—	○	R/V
	○	○	○	—	—	—	—	MGP□M
	○	—	—	—	—	—	—	MGPM□G
	○	○	○	○	○	○	○	MGP□F
	○	○	○	—	—	—	—	-XA□
	○	—	—	○	—	—	○	-XB6
	○	○	○	○	○	○	○	-XB10
	○	○	○	○	○	○	○	-XB13
	—	—	—	○	○	○	○	-XB22
	○	○	○	○	○	○	○	-XC4
	○	○	—	○	○	—	○	-XC6
	—	—	—	—	—	—	○	-XC8
	—	—	—	—	—	—	○	-XC9
	◎	◎	◎	—	—	—	—	-XC19
	○	—	—	○	—	—	○	-XC22
	○	○	○	○	○	○	○	-XC35
	—	—	—	—	—	—	○	-XC69
	◎	◎	◎	◎	◎	◎	○	-XC79
	○	—	—	○	—	—	○	-XC82
	◎	◎	◎	—	—	—	◎	-XC85
	○	○	○	○	○	○	○	-XC88
	○	○	○	○	○	○	○	-XC89W
	○	○	○	○	○	○	○	-XC91
	○	○	—	○	○	○	○	-XC92
	○	○	○	○	○	○	○	-X144
	○	○	○	○	○	○	○	-X471
	◎	◎	◎	◎	◎	◎	◎	-X867





# CONTENTS

## Compact Guide Cylinder *Series MGP*



### ● Compact Guide Cylinder/Basic Type *Series MGP-Z*

How to Order .....	Page 9
Specifications .....	Page 10
Model Selection .....	Page 16
Construction .....	Page 24
Dimensions .....	Page 26

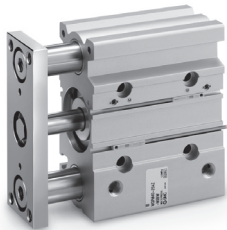

### ● Compact Guide Cylinder/With Air Cushion *Series MGP-AZ*

How to Order .....	Page 29
Specifications .....	Page 30
Model Selection .....	Page 33
Construction .....	Page 41
Dimensions .....	Page 43

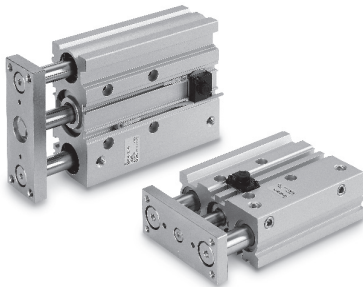

### ● Compact Guide Cylinder/With End Lock *Series MGP*

How to Order .....	Page 46
Specifications .....	Page 47
Construction .....	Page 49
Dimensions .....	Page 51
Specific Product Precautions .....	Page 54

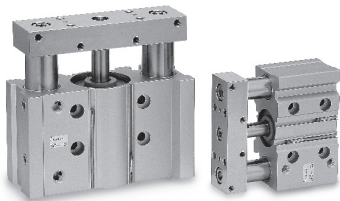

### ● Compact Guide Cylinder/Heavy Duty Guide Rod Type *Series MGPS*

How to Order .....	Page 55
Specifications .....	Page 56
Model Selection .....	Page 57
Construction .....	Page 61
Dimensions .....	Page 62

● Auto Switch Mounting .....	Page 63
● Prior to Use .....	Page 68
● Simple Specials/Made to Order .....	Page 69
● Specific Product Precautions .....	Page 92

Basic Type  
**MGP-Z**

With Air Cushion  
**MGP-AZ**

With End Lock  
**MGP**

Heavy Duty Guide Rod Type  
**MGPS**

Auto Switch

Made to Order

# Compact Guide Cylinder

# Series MGP

Ø 12, Ø 16, Ø 20, Ø 25, Ø 32, Ø 40, Ø 50, Ø 63, Ø 80, Ø 100

## How to Order

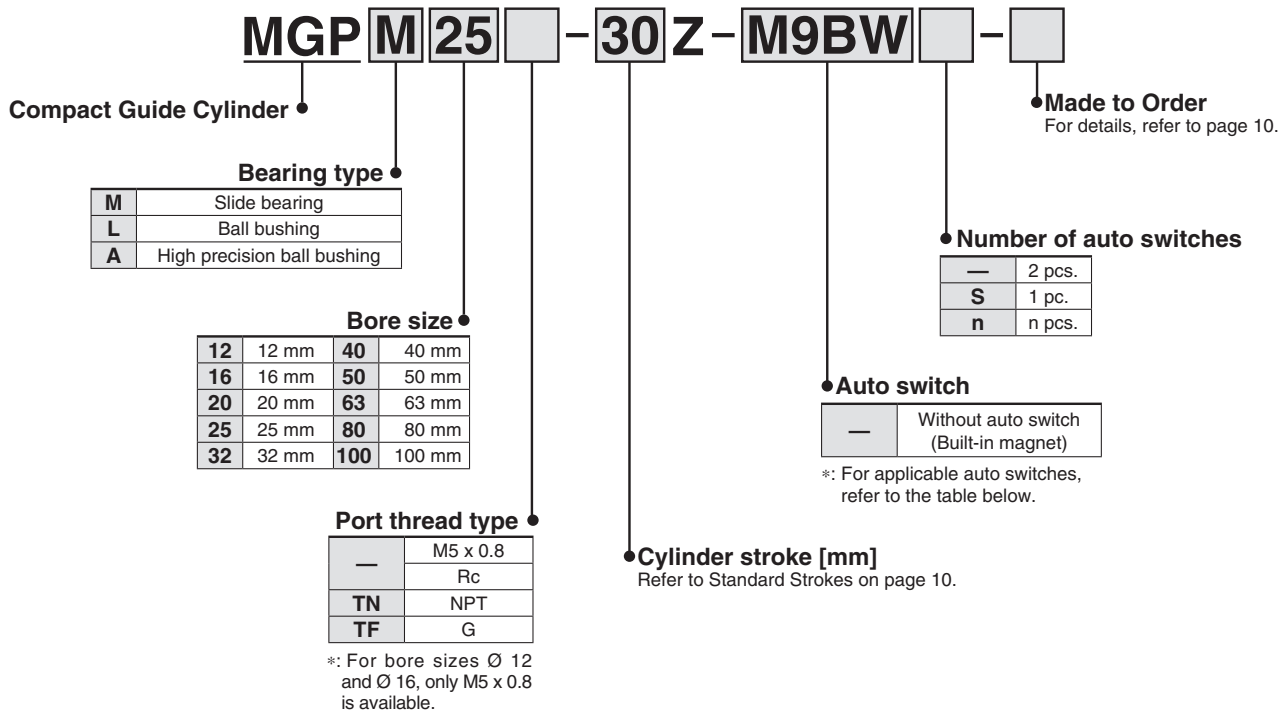

## Applicable Auto Switches/Refer to the Auto Switch Guide for further information on auto switches.

Type	Special function	Electrical entry	Indicator light	Wiring (Output)	Load voltage		Auto switch model		Lead wire length [m]				Pre-wired connector	Applicable load			
					DC	AC	Perpendicular	In-line	0.5 (—)	1 (M)	3 (L)	5 (Z)					
Solid state auto switch	—	Grommet	Yes	3-wire (NPN)	5 V, 12 V	24 V	—	M9NV	M9N	●	●	●	○	○	IC circuit	Relay, PLC	
				3-wire (PNP)				M9PV	M9P	●	●	●	○	○			
	2-wire			M9BV	M9B			●	●	●	○	○	○	○	—		
	3-wire (NPN)			M9NWX	M9NW			●	●	●	○	○	○	○	IC circuit		
	3-wire (PNP)			M9PWV	M9PW			●	●	●	○	○	○	○	IC circuit		
	2-wire			M9BWX	M9BW			●	●	●	○	○	○	○	—		
	3-wire (NPN)			M9NAV*1	M9NA*1			○	○	●	○	○	○	○	IC circuit		
	3-wire (PNP)			M9PAV*1	M9PA*1			○	○	●	○	○	○	○	IC circuit		
	2-wire			M9BAV*1	M9BA*1			○	○	●	○	○	○	○	—		
	2-wire (Non-polar)			—	P3DWA*2			●	—	●	●	○	○	○	—		
Reed auto switch	—	Grommet	Yes	3-wire (NPN equivalent)	—	5 V	—	A96V	A96	●	—	●	—	—	IC circuit	—	
				2-wire	24 V	12 V	100 V	A93V*3	A93	●	●	●	●	—	—	—	Relay, PLC
							100 V or less	A90V	A90	●	—	●	—	—	—	IC circuit	—

\*1: Water resistant type auto switches are mountable on the above models, but in such case SMC cannot guarantee water resistance.

A water resistant type cylinder is recommended for use in an environment which requires water resistance.

However, please contact SMC for water resistant products of Ø 12 and Ø 16.

\*2: The D-P3DWA□ is mountable on bore size Ø 25 to Ø 100.

\*3: 1 m type lead wire is only applicable to the D-A93.

\*: Lead wire length symbols: 0.5 m.....— (Example) M9NW  
 1 m.....M (Example) M9NWM  
 3 m.....L (Example) M9NWL  
 5 m.....Z (Example) M9NWZ

\*: Solid state auto switches marked with "○" are produced upon receipt of order.

\*: Other than the auto switches listed above, the D-P4DW type can be mounted. Refer to page 66 for details.

\*: For details about auto switches with pre-wired connector, refer to the Auto Switch Guide.

For the D-P3DWA□, refer to the Auto Switch Guide.

\*: Auto switches are shipped together, (but not assembled).

## Specifications

Bore size [mm]	12	16	20	25	32	40	50	63	80	100
<b>Action</b>	Double acting									
<b>Fluid</b>	Air									
<b>Proof pressure</b>	1.5 MPa									
<b>Maximum operating pressure</b>	1.0 MPa									
<b>Minimum operating pressure</b>	0.12 MPa		0.1 MPa							
<b>Ambient and fluid temperature</b>	-10 to 60 °C (No freezing)									
<b>Piston speed *1</b>	50 to 500 mm/s								50 to 400 mm/s	
<b>Cushion</b>	Rubber bumper on both ends									
<b>Lubrication</b>	Not required (Non-lube)									
<b>Stroke length tolerance</b>	+1.5 0 mm									

\*1: Maximum speed with no load. Depending on the operating conditions, the piston speed may not be satisfied.  
Make a model selection, considering a load according to the graph on pages 16 to 22.

## Standard Strokes

Bore size [mm]	Standard stroke [mm]
<b>12, 16</b>	10, 20, 30, 40, 50, 75, 100, 125, 150, 175, 200, 250
<b>20, 25</b>	20, 30, 40, 50, 75, 100, 125, 150, 175, 200, 250, 300, 350, 400
<b>32 to 100</b>	25, 50, 75, 100, 125, 150, 175, 200, 250, 300, 350, 400

## Manufacture of Intermediate Strokes

Description	Spacer installation type Spacers are installed in the standard stroke cylinder. • Ø 12 to Ø 32: Available in 1 mm stroke increments. • Ø 40 to Ø 100: Available in 5 mm stroke increments.	Exclusive body (-XB10) Dealing with the stroke by making an exclusive body. • All bore sizes are available in 1 mm increments.		
<b>Model no.</b>	Refer to How to Order for the standard model numbers.	Add "-XB10" to the end of standard model number. For details, refer to Made to Order.		
<b>Applicable stroke [mm]</b>	Ø 12, Ø 16	1 to 249	Ø 12, Ø 16	11 to 249
	Ø 20, Ø 25, Ø 32	1 to 399	Ø 20, Ø 25	21 to 399
	Ø 40 to Ø 100	5 to 395	Ø 32 to Ø 100	26 to 399
<b>Example</b>	Part no.: MGPM20-39Z A spacer 1 mm in width is installed in the MGPM20-40. C dimension is 77 mm.	Part no.: MGPM20-39Z-XB10 Special body manufactured for 39 stroke. C dimension is 76 mm.		

## Theoretical Output

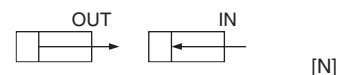

Bore size [mm]	Rod size [mm]	Operating direction	Piston area [mm <sup>2</sup> ]	Operating pressure [MPa]								
				0.2	0.3	0.4	0.5	0.6	0.7	0.8	0.9	1.0
<b>12</b>	6	OUT	113	23	34	45	57	68	79	90	102	113
		IN	85	17	25	34	42	51	59	68	76	85
<b>16</b>	8	OUT	201	40	60	80	101	121	141	161	181	201
		IN	151	30	45	60	75	90	106	121	136	151
<b>20</b>	10	OUT	314	63	94	126	157	188	220	251	283	314
		IN	236	47	71	94	118	141	165	188	212	236
<b>25</b>	10	OUT	491	98	147	196	245	295	344	393	442	491
		IN	412	82	124	165	206	247	289	330	371	412
<b>32</b>	14	OUT	804	161	241	322	402	483	563	643	724	804
		IN	650	130	195	260	325	390	455	520	585	650
<b>40</b>	14	OUT	1257	251	377	503	628	754	880	1005	1131	1257
		IN	1103	221	331	441	551	662	772	882	992	1103
<b>50</b>	18	OUT	1963	393	589	785	982	1178	1374	1571	1767	1963
		IN	1709	342	513	684	855	1025	1196	1367	1538	1709
<b>63</b>	18	OUT	3117	623	935	1247	1559	1870	2182	2494	2806	3117
		IN	2863	573	859	1145	1431	1718	2004	2290	2576	2863
<b>80</b>	22	OUT	5027	1005	1508	2011	2513	3016	3519	4021	4524	5027
		IN	4646	929	1394	1859	2323	2788	3252	3717	4182	4646
<b>100</b>	26	OUT	7854	1571	2356	3142	3927	4712	5498	6283	7069	7854
		IN	7323	1465	2197	2929	3662	4394	5126	5858	6591	7323

\*: Theoretical output [N] = Pressure [MPa] x Piston area [mm<sup>2</sup>]

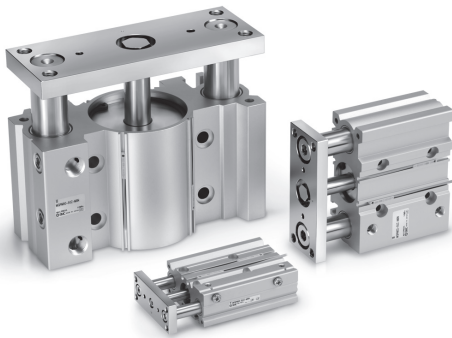

**Symbol**  
Rubber bumper

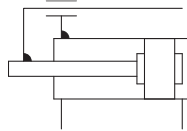

**Made to Order**  
(For details, refer to pages 69 to 89.)

Symbol	Specifications
-XA□	Change of guide rod end shape
-XB6	Heat resistant cylinder (-10 to 150 °C)
-XB10	Intermediate stroke (Using exclusive body)
-XB13	Low speed cylinder (5 to 50 mm/s)
-XB22	Shock absorber soft type <i>series RJ</i> type
-XC4	With heavy duty scraper
-XC6	Made of stainless steel
-XC8	Adjustable stroke cylinder/Adjustable extension type
-XC9	Adjustable stroke cylinder/Adjustable retraction type
-XC22	Fluororubber seal
-XC35	With coil scraper
-XC69	With shock absorber *1
-XC79	Tapped hole, drilled hole, pinned hole machined additionally
-XC82	Bottom mounting type
-XC85	Grease for food processing equipment
-XC88	Spatter resistant coil scraper, Lube-retainer, Grease for welding (Rod parts: Stainless steel 304)
-XC89W	Spatter resistant coil scraper, Lube-retainer, Grease for welding (Rod parts: S45C)
-XC91	Spatter resistant coil scraper, Grease for welding (Rod parts: S45C)
-XC92	Dust resistant actuator *1
-X144	Symmetrical port position
-X471	Enlarged plate and body gap dimensions
-X867	Side porting type (Plug location changed)

\*1: The shape is the same as the current product.

Refer to pages 63 to 67 for cylinders with auto switches.

- Auto switch proper mounting position (detection at stroke end) and its mounting height
- Minimum stroke for auto switch mounting
- Operating range
- Auto switch mounting brackets/Part no.
- Auto Switch Mounting

Basic Type  
**MGP-Z**

With Air Cushion  
**MGP-AZ**

With End Lock  
**MGP**

Heavy Duty Guide Rod Type  
**MGPS**

Auto Switch

Made to Order

# Series MGP

## Weights

### Slide Bearing: MGPM12 to 100

[kg]

Bore size [mm]	Standard stroke [mm]															
	10	20	25	30	40	50	75	100	125	150	175	200	250	300	350	400
12	0.22	0.25	—	0.29	0.33	0.36	0.46	0.55	0.66	0.75	0.84	0.93	1.11	—	—	—
16	0.32	0.37	—	0.42	0.46	0.51	0.66	0.78	0.94	1.06	1.18	1.31	1.55	—	—	—
20	—	0.59	—	0.67	0.74	0.82	1.06	1.24	1.43	1.61	1.80	1.99	2.42	2.79	3.16	3.53
25	—	0.84	—	0.94	1.04	1.14	1.50	1.75	2.00	2.25	2.50	2.75	3.35	3.85	4.34	4.84
32	—	—	1.41	—	—	1.77	2.22	2.57	2.93	3.29	3.65	4.00	4.90	5.61	6.33	7.04
40	—	—	1.64	—	—	2.04	2.52	2.92	3.32	3.71	4.11	4.50	5.47	6.26	7.06	7.85
50	—	—	2.79	—	—	3.38	4.13	4.71	5.30	5.89	6.47	7.06	8.55	9.73	10.9	12.1
63	—	—	3.48	—	—	4.15	4.99	5.67	6.34	7.02	7.69	8.37	10.0	11.4	12.7	14.1
80	—	—	5.41	—	—	6.26	7.41	8.26	9.10	9.95	10.8	11.6	13.9	15.6	17.3	19.0
100	—	—	9.12	—	—	10.3	12.0	13.2	14.4	15.6	16.9	18.1	21.2	23.6	26.1	28.5

### Ball Bushing: MGPL12 to 100, High Precision Ball Bushing: MGPA12 to 100

[kg]

Bore size [mm]	Standard stroke [mm]															
	10	20	25	30	40	50	75	100	125	150	175	200	250	300	350	400
12	0.21	0.24	—	0.27	0.32	0.35	0.43	0.50	0.59	0.67	0.75	0.83	0.99	—	—	—
16	0.31	0.35	—	0.40	0.47	0.51	0.62	0.72	0.85	0.96	1.06	1.17	1.38	—	—	—
20	—	0.60	—	0.66	0.79	0.85	1.01	1.17	1.36	1.52	1.68	1.84	2.17	2.49	2.81	3.13
25	—	0.87	—	0.96	1.12	1.20	1.41	1.62	1.86	2.06	2.27	2.48	2.92	3.33	3.75	4.16
32	—	—	1.37	—	—	1.66	2.08	2.37	2.74	3.03	3.31	3.60	4.25	4.82	5.39	5.97
40	—	—	1.59	—	—	1.92	2.38	2.70	3.11	3.44	3.77	4.09	4.81	5.46	6.11	6.76
50	—	—	2.65	—	—	3.14	3.85	4.34	4.97	5.47	5.96	6.45	7.57	8.56	9.54	10.5
63	—	—	3.33	—	—	3.91	4.71	5.29	6.01	6.59	7.17	7.75	9.05	10.2	11.4	12.5
80	—	—	5.27	—	—	6.29	7.49	8.21	8.92	9.64	10.4	11.1	12.9	14.3	15.7	17.2
100	—	—	8.62	—	—	10.1	11.8	12.9	13.9	15.0	16.0	17.1	19.6	21.7	23.8	25.9

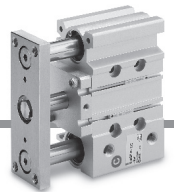

## ① Clean Series

Applicable in a clean room environment. Ideal for use in conveyor lines for semiconductor (LSI), liquid crystal (LCD), food processing, pharmaceutical, and electronic parts, etc.

### How to Order

**12** — MGPL Bore size — Stroke Z

● Clean room specifications

12	Relief port type
13	Vacuum port type

● Thread type

—	M5 x 0.8
	Rc
N	NPT
TF	G

\*: For bore sizes 12 and 16, M5 x 0.8 is only available.

### Specifications

Applicable series	MGPL							
Bearing type	Ball bushing bearing							
Bore size [mm]	12	16	20	25	32	40	50	63
Stroke [mm]	10 to 250		20 to 400			25 to 400		

\*: Specifications other than above are the same as standard, basic style.

### Dimensions

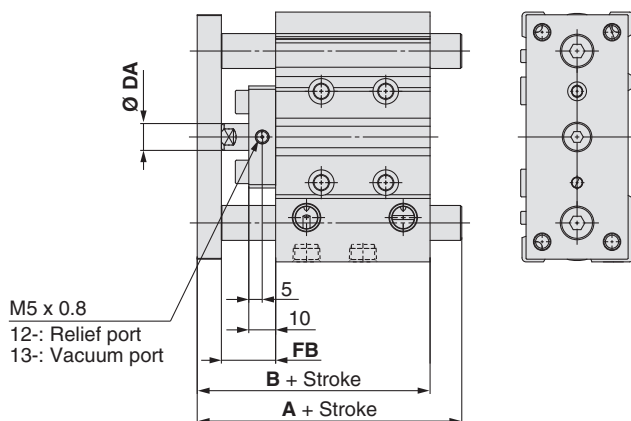

\*: Other dimensions are the same as standard products. \*: The dimensions in ( ) are the same as standard type.

Bore size [mm]	A				B	DA	FB
	30 st or less	Over 30 st and up to 100 st	Over 100 st and up to 200 st	Over 200 st			
12	56	68	97.5	97.5	55	(6)	19
16	62	78	107.5	107.5	59	(8)	19
20	72	89	113	130.5	66	(10)	21
25	78.5	94.5	113.5	130.5	66.5	(10)	20

\*: For bore size Ø 12 and Ø 16, only M5 x 0.8 port is available.

\*: For bore size Ø 20 or more, choice of Rc, NPT, G port is available. (Refer to page 9.)

Bore size [mm]	A				B	DA	FB
	50 st or less	Over 50 st and up to 100 st	Over 100 st and up to 200 st	Over 200 st			
32	91.5	108.5	128.5	150.5	71.5	(14)	24
40	91.5	108.5	128.5	150.5	78	(14)	24
50	102.5	123.5	143.5	170.5	83	20	27
63	102.5	123.5	143.5	170.5	88	20	27

\*: Choice of Rc, NPT, G port is available. (Refer to page 9.)

## ② Water Resistant Cylinder

Ideal for use in a machine tool environment exposed to coolants. Applicable for use in an environment with water splashing such as food processing and car wash equipment, etc.



### How to Order

MGPM Bore size R - Stroke Z - M9□A(V)L - XC6A

**Thread type**

—	Rc
TN	NPT
TF	G

**Water Resistant Cylinder**

R	NBR seals (Nitrile rubber)
V	FKM seals (Fluororubber)

**Made to Order**

- \*: Piston rod and guide rod are made of stainless steel.
- \*: Please contact SMC when using liquids that contain sulfur.

### Specifications

Applicable series	MGPM	
<b>Bearing type</b>	Slide bearing	
<b>Bore size [mm]</b>	20, 25, 32, 40, 50, 63, 80, 100	
<b>Cushion</b>	MGPM□□R	Rubber bumper
	MGPM□□V	Without cushion
<b>Minimum operating pressure</b>	0.13 MPa	
<b>Made to order</b>	XC6A	Specified parts made of stainless steel

- \*: Specifications other than above are the same as standard, basic type.
- \*: For details on the made-to-order XC6A with specified parts made of stainless steel.

### Dimensions

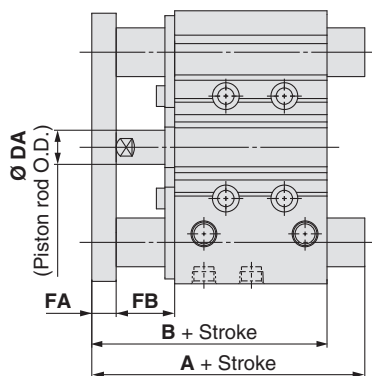

#### Water resistant

Bore size [mm]	A			B	DA	FA	FB
	50 st or less	Over 50 st and up to 200 st	Over 200 st				
20	66	90.5	123	66	(10)	(8)	21
25	67.5	91.5	123.5	67.5	(10)	(9)	21
32	87	105.5	141.5	71.5	(14)	(10)	24
40	87	105.5	141.5	78	(14)	(10)	24
50	99.5	120.5	161.5	83	20	(12)	27
63	99.5	120.5	161.5	88	20	(12)	27
80	110.5	137.5	186.5	102.5	25	(16)	30
100	130.5	155.5	194.5	120	30	(19)	35

#### Water resistant + XC6A

Bore size [mm]	A			B	DA	FA	FB
	50 st or less	Over 50 st and up to 200 st	Over 200 st				
20	66	90.5	123	66	(10)	9	20
25	67.5	91.5	123.5	67.5	(10)	10	20
32	87	105.5	141.5	71.5	(14)	12	22
40	87	105.5	141.5	78	(14)	12	22
50	99.5	120.5	161.5	83	20	16	23
63	99.5	120.5	161.5	88	20	16	23
80	110.5	137.5	186.5	102.5	25	19	27
100	130.5	155.5	194.5	120	30	22	32

## ③ Cylinder with Stable Lubrication Function (Lube-retainer)

Improves durability in environments with micro-powder. (Compared with the standard model)  
In addition, the overall length and mounting are the same as those of the standard model.

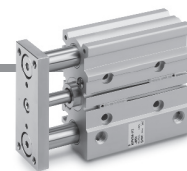

### How to Order

MGP Bearing type Bore size Port thread type M - Stroke Z - Auto switch

### Dimensions (Dimensions are the same as the standard type.)

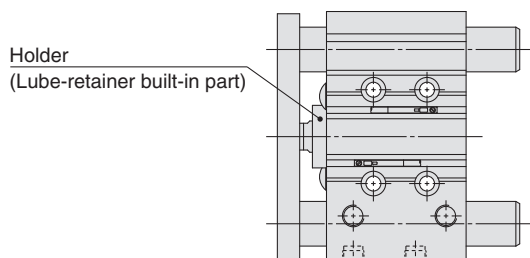

• Cylinder with stable lubrication function (Lube-retainer)

### Specifications

Bore size [mm]	20, 25, 32, 40, 50, 63, 80, 100
<b>Action</b>	Double acting
<b>Minimum operating pressure</b>	0.15 MPa
<b>Cushion</b>	Rubber bumper on both ends

- \*: Specifications other than above are the same as standard, basic style.

For details, refer to the catalogue on [www.smc.eu](http://www.smc.eu).

# Series MGP

## ④ Guide Unit with Lube-retainer

### How to Order

MGP **M** **Bore size** **Port thread type** **G** — **Stroke** **Z** — **Auto switch**

Slide bearing      Guide unit with Lube-retainer

### Dimensions (Dimensions other than below are the same as standard type.)

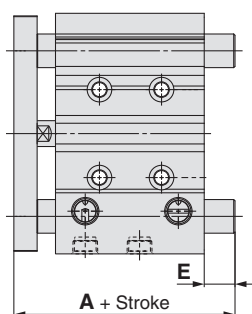

Bore size [mm]	A			E		
	50 st or less	Over 50 st to 200 st	Over 200 st	50 st or less	Over 50 st to 200 st	Over 200 st
20	(53)	83	115.5	(0)	30	62.5
25	(53.5)	83.5	115.5	(0)	30	62
32	82	100.5	136.5	22.5	41	77
40	82	100.5	136.5	16	34.5	70.5
50	95.5	116.5	157.5	23.5	44.5	85.5
63	95.5	116.5	157.5	18.5	39.5	80.5
80	113.5	140.5	189.5	17	44	93
100	135.5	160.5	199.5	19.5	44.5	83.5

The dimensions in ( ) are the same as standard type.

## ⑤ With flange

Plate side flange type is added

### How to Order

MGP **Bearing Type** **F** **Bore size** **Port thread type** — **Stroke** **Z** — **Auto switch**

Flange

Specifications: Same as standard type

### ⚠ Caution

This product cannot be used as a stopper.



### Dimensions (Dimensions other than below are the same as the standard type.)

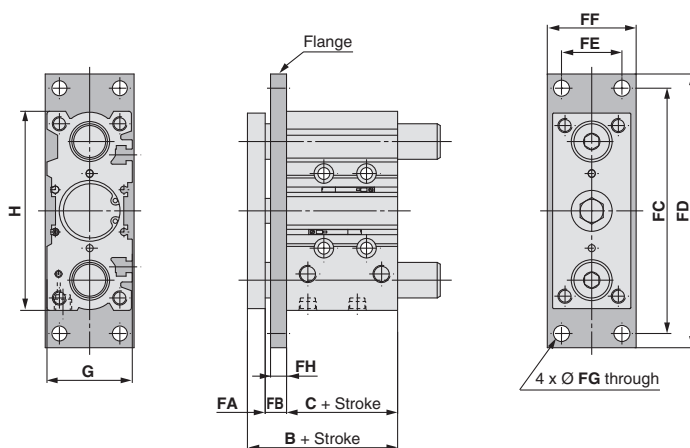

Bore size	B	C	FA	FB	FC	FD	FE	FF	FG	FH	G	H	Flange weight (kg)
12	42	29	7	6	80	89	18	25	4.5	5	26	58	0.08
16	46	33	7	6	88	98	22	32	5.5	5	30	64	0.11
20	53	37	8	8	102	112	24	38	5.5	6	36	83	0.17
25	53.5	37.5	9	7	114	126	30	40	6.6	6	42	93	0.20
32	59.5	37.5	10	12	138	154	34	50	9	9	48	112	0.46
40	66	44	10	12	146	162	40	60	9	9	54	120	0.60
50	72	44	12	16	178	198	46	65	11	10	64	148	0.87
63	77	49	12	16	192	212	58	75	11	10	78	162	1.09
80	96.5	56.5	16	24	238	262	54	90	13.5	16	91.5	202	2.59
100	116	66	19	31	280	308	62	100	15.5	22	111.5	240	4.63

## Allowable Rotational Torque of Plate

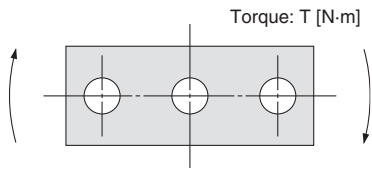

Bore size [mm]	Bearing type	Stroke [mm]															
		10	20	25	30	40	50	75	100	125	150	175	200	250	300	350	400
12	MGPM	0.39	0.32	—	0.27	0.24	0.21	0.43	0.36	0.31	0.27	0.24	0.22	0.19	—	—	—
	MGPL/A	0.61	0.45	—	0.35	0.58	0.50	0.37	0.29	0.24	0.20	0.18	0.16	0.12	—	—	—
16	MGPM	0.69	0.58	—	0.49	0.43	0.38	0.69	0.58	0.50	0.44	0.40	0.36	0.30	—	—	—
	MGPL/A	0.99	0.74	—	0.59	0.99	0.86	0.65	0.52	0.43	0.37	0.32	0.28	0.23	—	—	—
20	MGPM	—	1.05	—	0.93	0.83	0.75	1.88	1.63	1.44	1.28	1.16	1.06	0.90	0.78	0.69	0.62
	MGPL/A	—	1.26	—	1.03	2.17	1.94	1.52	1.25	1.34	1.17	1.03	0.93	0.76	0.65	0.56	0.49
25	MGPM	—	1.76	—	1.55	1.38	1.25	2.96	2.57	2.26	2.02	1.83	1.67	1.42	1.24	1.09	0.98
	MGPL/A	—	2.11	—	1.75	3.37	3.02	2.38	1.97	2.05	1.78	1.58	1.41	1.16	0.98	0.85	0.74
32	MGPM	—	—	6.35	—	—	5.13	5.69	4.97	4.42	3.98	3.61	3.31	2.84	2.48	2.20	1.98
	MGPL/A	—	—	5.95	—	—	4.89	5.11	4.51	6.34	5.79	5.33	4.93	4.29	3.78	3.38	3.04
40	MGPM	—	—	7.00	—	—	5.66	6.27	5.48	4.87	4.38	3.98	3.65	3.13	2.74	2.43	2.19
	MGPL/A	—	—	6.55	—	—	5.39	5.62	4.96	6.98	6.38	5.87	5.43	4.72	4.16	3.71	3.35
50	MGPM	—	—	13.0	—	—	10.8	12.0	10.6	9.50	8.60	7.86	7.24	6.24	5.49	4.90	4.43
	MGPL/A	—	—	9.17	—	—	7.62	9.83	8.74	11.6	10.7	9.83	9.12	7.95	7.02	6.26	5.63
63	MGPM	—	—	14.7	—	—	12.1	13.5	11.9	10.7	9.69	8.86	8.16	7.04	6.19	5.52	4.99
	MGPL/A	—	—	10.2	—	—	8.48	11.0	9.74	13.0	11.9	11.0	10.2	8.84	7.80	6.94	6.24
80	MGPM	—	—	21.9	—	—	18.6	22.9	20.5	18.6	17.0	15.6	14.5	12.6	11.2	10.0	9.11
	MGPL/A	—	—	15.1	—	—	23.3	22.7	20.6	18.9	17.3	16.0	14.8	12.9	11.3	10.0	8.94
100	MGPM	—	—	38.8	—	—	33.5	37.5	33.8	30.9	28.4	26.2	24.4	21.4	19.1	17.2	15.7
	MGPL/A	—	—	27.1	—	—	30.6	37.9	34.6	31.8	29.3	27.2	25.3	22.1	19.5	17.3	15.5

## Non-rotating Accuracy of Plate

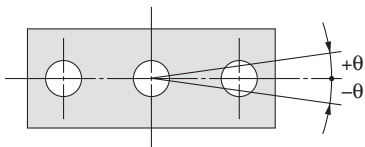

Non-rotating accuracy  $\theta$  when retracted and when no load is applied should be not more than the values shown in the table.

Bore size [mm]	Non-rotating accuracy $\theta$		
	MGPM	MGPL	MGPA
12	$\pm 0.07^\circ$	$\pm 0.05^\circ$	$\pm 0.01^\circ$
16			
20	$\pm 0.06^\circ$	$\pm 0.04^\circ$	
25			
32	$\pm 0.05^\circ$	$\pm 0.03^\circ$	
40			
50	$\pm 0.04^\circ$	$\pm 0.03^\circ$	
63			
80	$\pm 0.03^\circ$	$\pm 0.03^\circ$	
100			

## High Precision Ball Bushing/MGPA

### ⚠ Caution

#### Positioning accuracy for pin hole on the plate

Dispersion of dimensions when machining each component will be accumulated in the plate pin hole positioning accuracy when mounting this cylinder. Values below are referred as a guide.

[Side mounting]

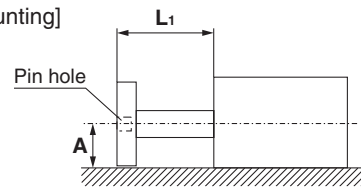

$$A = \text{Catalogue dimension} \pm \left( 0.1 + L_1 \times 0.0008 \right) \text{ [mm]}$$

\*: To be 0.15 for  $\varnothing 80$ ,  $\varnothing 100$

Note) Displacement by load and self-weight deflection by plate and guide rod are not included.

[Bottom mounting]

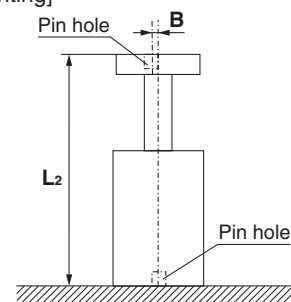

$$B = \pm \left( 0.045 + L_2 \times 0.0016 \right) \text{ [mm]}$$

Basic Type  
MGP-Z

With Air Cushion  
MGP-AZ

With End Lock  
MGP

Heavy Duty Guide Rod Type  
MGPS

Auto Switch

Made to Order

# Series MGP

## High Precision Ball Bushing/MGPA Plate Displacement Amount (Reference Values)

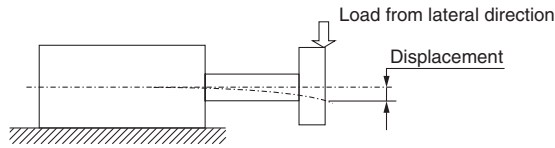

### MGPA12

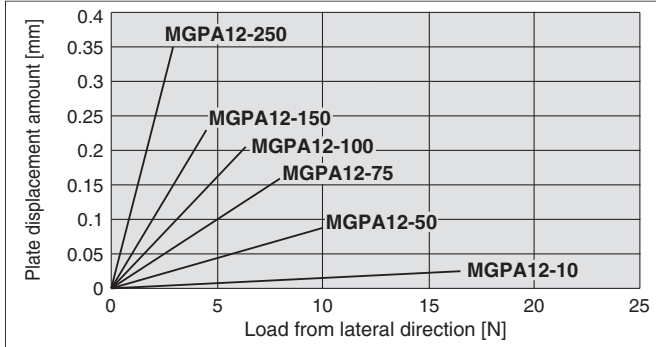

### MGPA32, 40

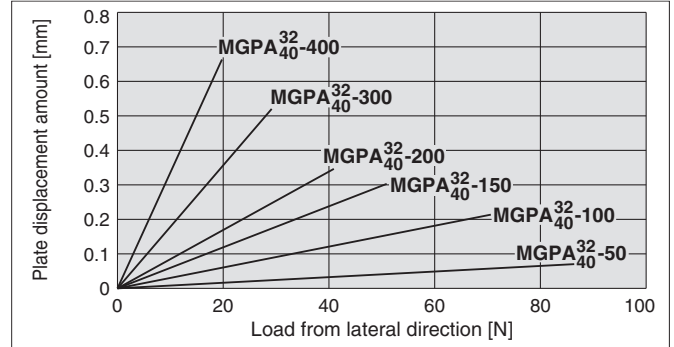

### MGPA16

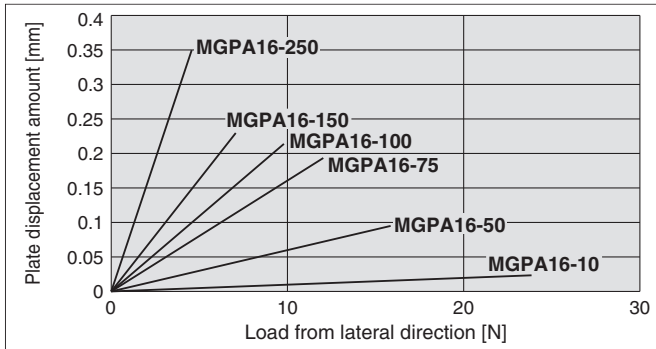

### MGPA50, 63

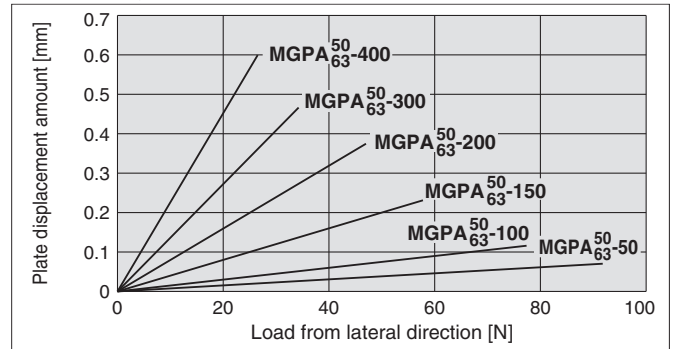

### MGPA20

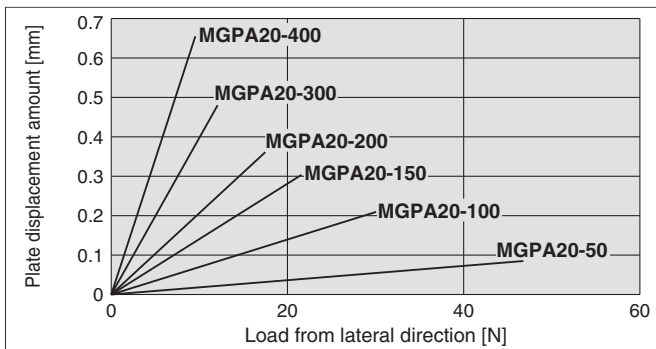

### MGPA80

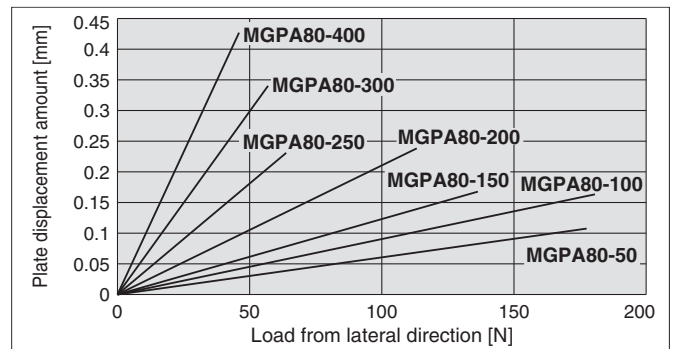

### MGPA25

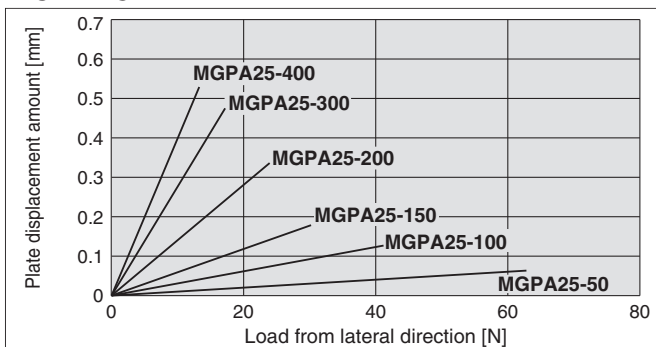

### MGPA100

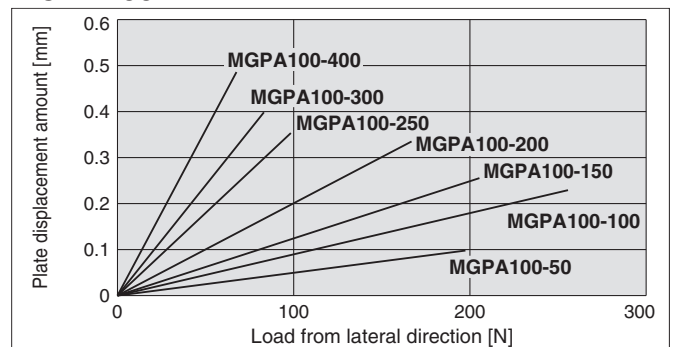

\*: The guide rod and self-weight for the plate are not included in the above displacement values.

\*: Allowable rotating torque, and operating range when used as a lifter, are the same as those of the MGPL series.



# Basic Type Series MGP Model Selection

## Selection Conditions

Mounting orientation	Vertical		Horizontal	
Maximum speed [mm/s]	200 or less	400	200 or less	400
Graph (Slide bearing)	(1), (2)	(3), (4)	(13), (14)	(15), (16)
Graph (Ball bushing)	(5) to (8)	(9) to (12)	(17), (18)	(19), (20)

### Selection Example 1 (Vertical Mounting)

#### Selection conditions

Mounting: Vertical  
Bearing type: Ball bushing  
Stroke: 30 stroke  
Maximum speed: 200 mm/s  
Work load: 3 kg  
Eccentric distance: 90 mm

Find the point of intersection for the work load of 3 kg and the eccentric distance of 90 mm on graph (5), based on vertical mounting, ball bushing, 30 stroke, and the speed of 200 mm/s.

→ **MGPL25-30Z** is selected.

(5) 30 stroke or less,  $V = 200$  mm/s or less

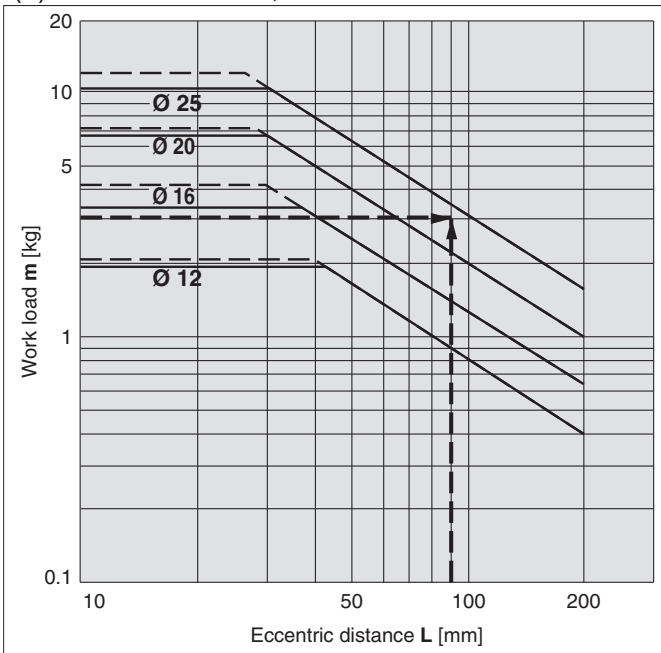

### Selection Example 2 (Horizontal Mounting)

#### Selection conditions

Mounting: Horizontal  
Bearing type: Slide bearing  
Distance between plate and load centre of gravity: 50 mm  
Maximum speed: 200 mm/s  
Work load: 2 kg  
Stroke: 30 stroke

Find the point of intersection for the work load of 2 kg and 30 stroke on graph (13), based on horizontal mounting, slide bearing, the distance of 50 mm between the plate and load centre of gravity, and the speed of 200 mm/s.

→ **MGPM20-30Z** is selected.

(13)  $L = 50$  mm,  $V = 200$  mm/s or less

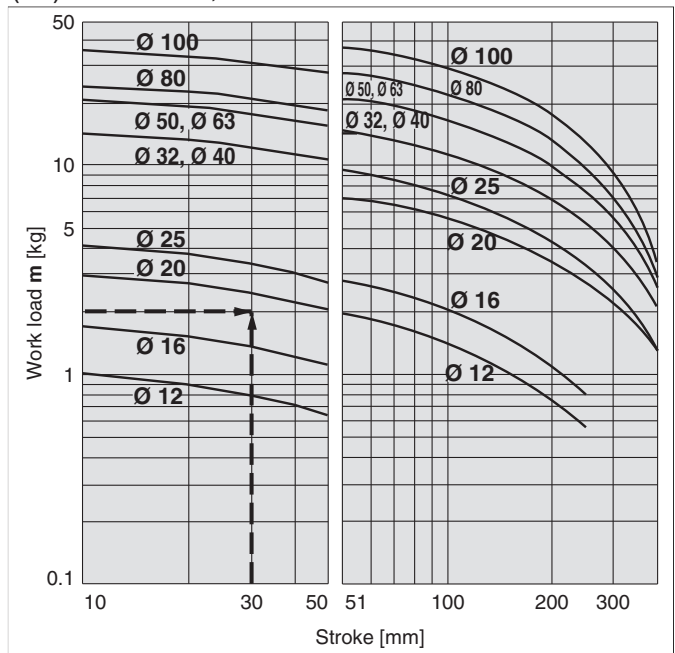

· When the maximum speed exceeds 200 mm/s, the allowable work load is determined by multiplying the value shown in the graph at 400 mm/s by the coefficient listed in the table below.

Max. speed	Up to 300 mm/s	Up to 400 mm/s	Up to 500 mm/s
Coefficient	1.7	1	0.6

· Use the Guide Cylinder Selection Software, when the eccentric distance is 200 mm or more.

# Series MGP

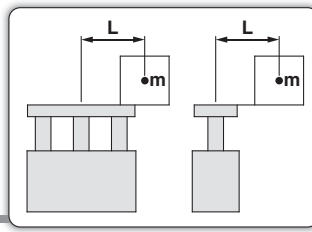

## Vertical Mounting Slide Bearing

— Operating pressure 0.4 MPa  
 - - - - - Operating pressure 0.5 MPa or more

### MGPM12 to 100

(1) 50 stroke or less,  $V = 200$  mm/s or less

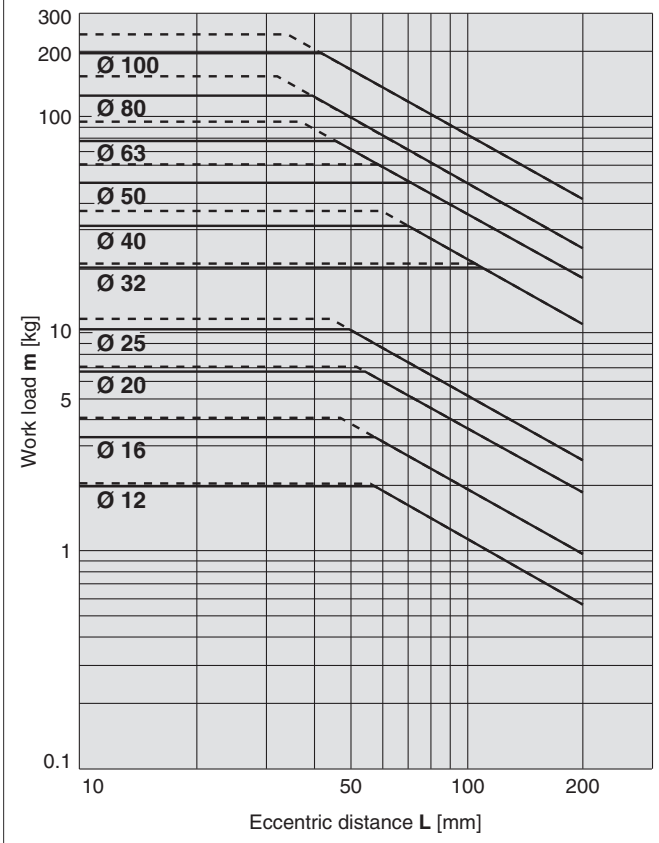

(2) Over 50 stroke,  $V = 200$  mm/s or less

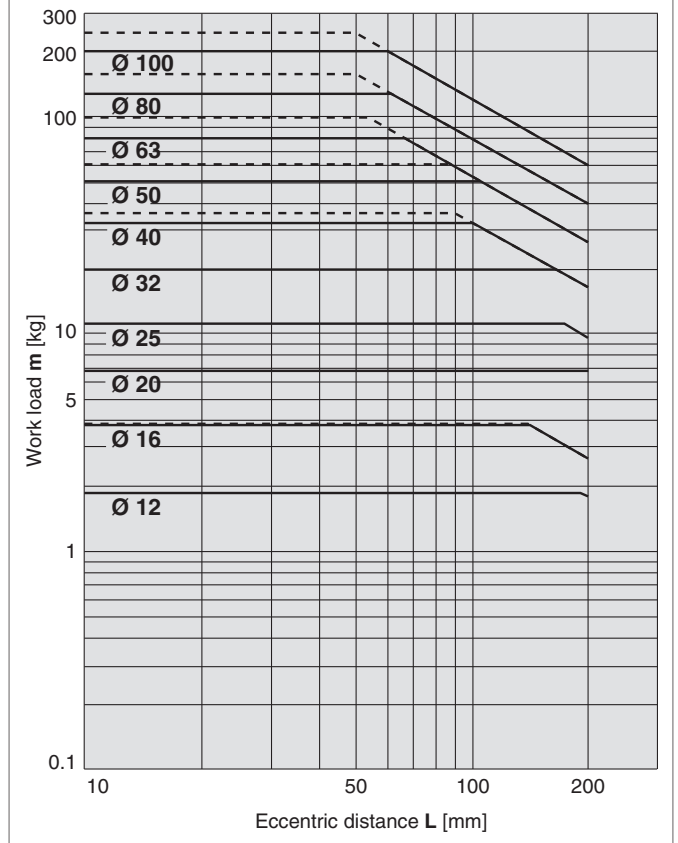

(3) 50 stroke or less,  $V = 400$  mm/s

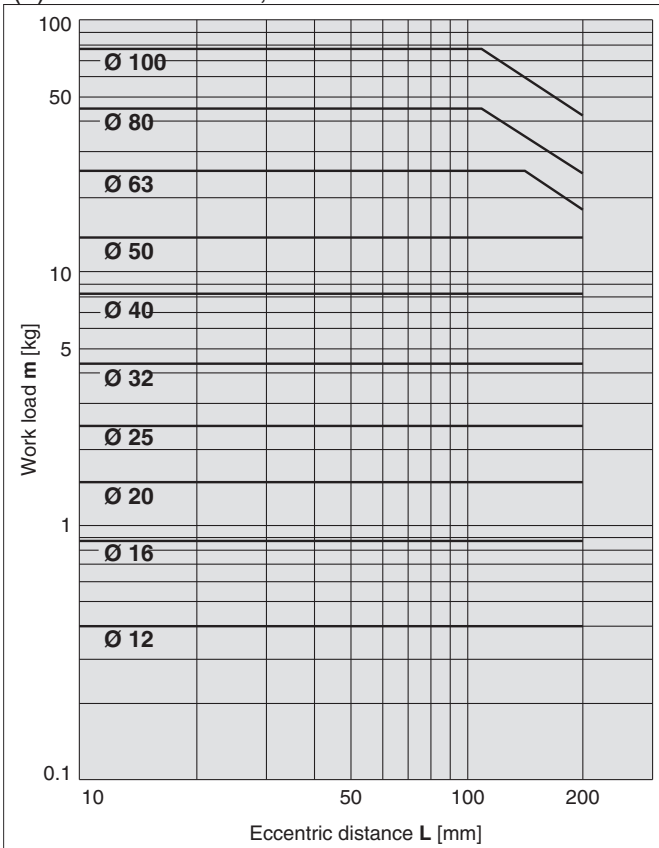

(4) Over 50 stroke,  $V = 400$  mm/s

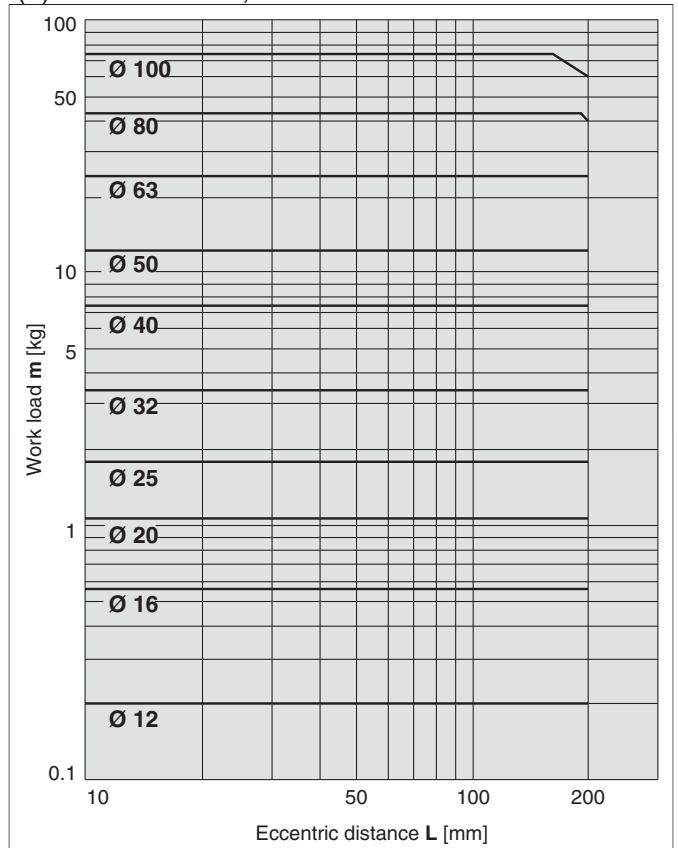

· Use the Guide Cylinder Selection Software, when the eccentric distance is 200 mm or more.

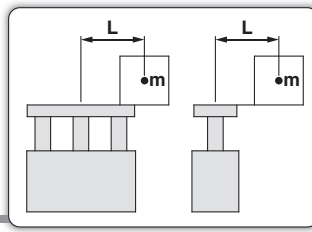

— Operating pressure 0.4 MPa  
 - - - - - Operating pressure 0.5 MPa or more

**Vertical Mounting** **Ball Bushing**

**MGPL12 to 25, MGPA12 to 25**

(5) 30 stroke or less, V = 200 mm/s or less

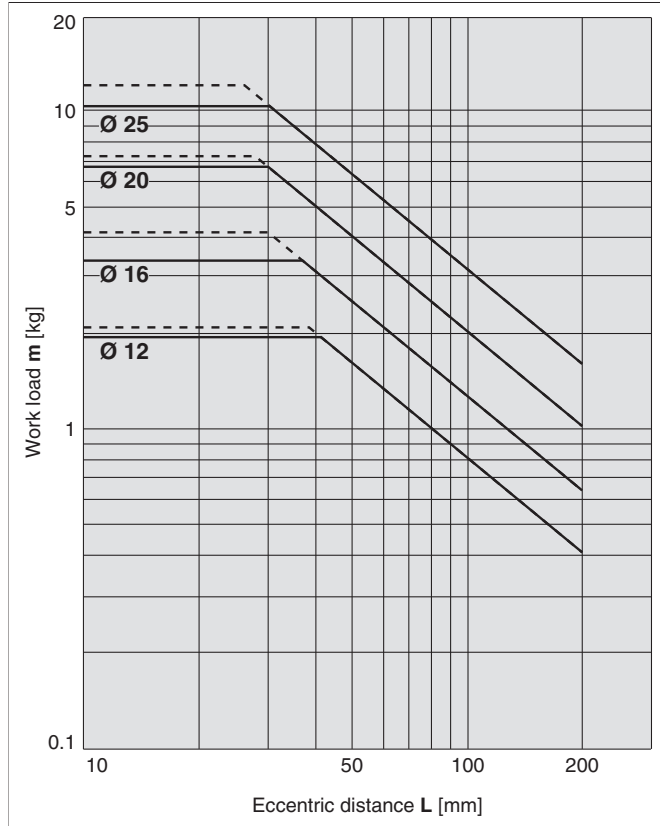

(6) Over 30 stroke, V = 200 mm/s or less

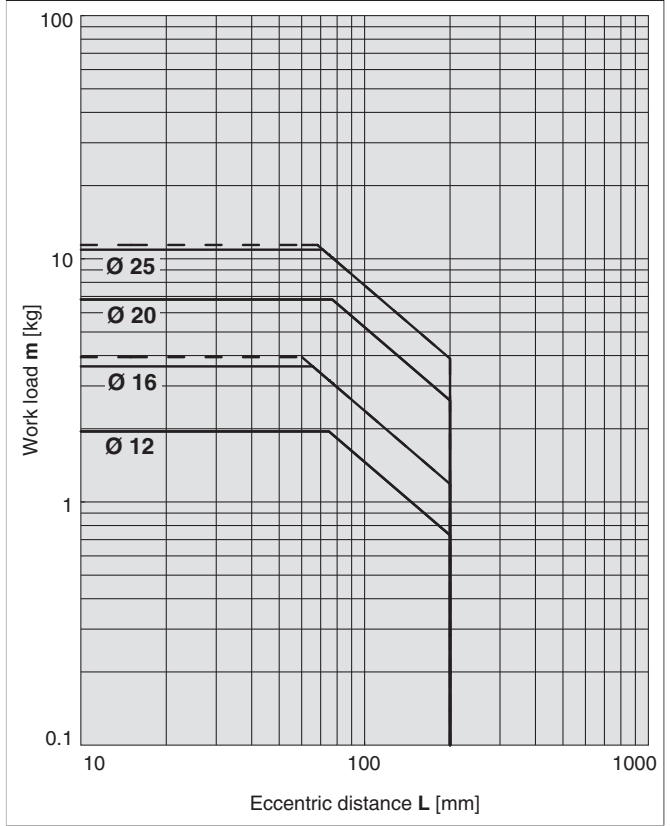

**MGPL32 to 100, MGPA32 to 100**

(7) 50 stroke or less, V = 200 mm/s or less

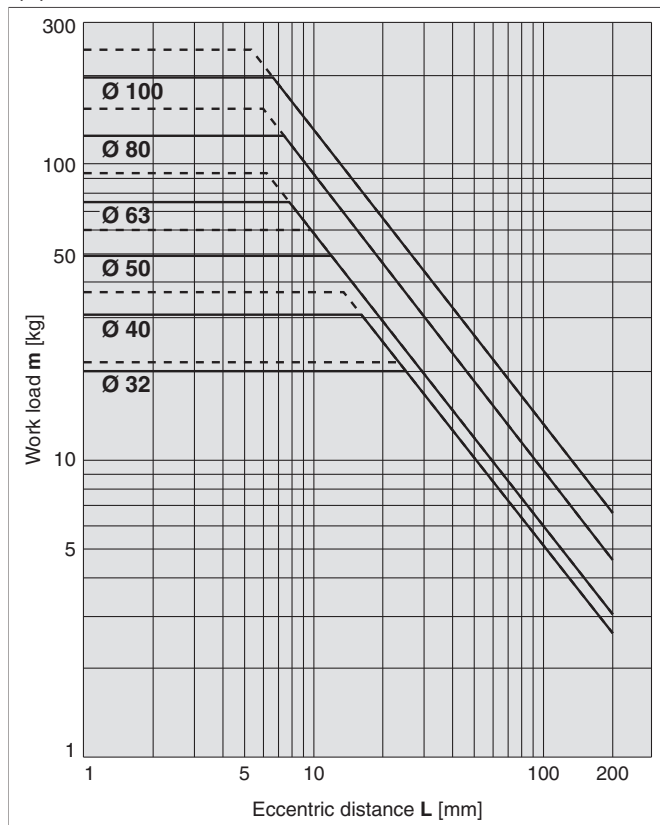

(8) Over 50 stroke, V = 200 mm/s or less

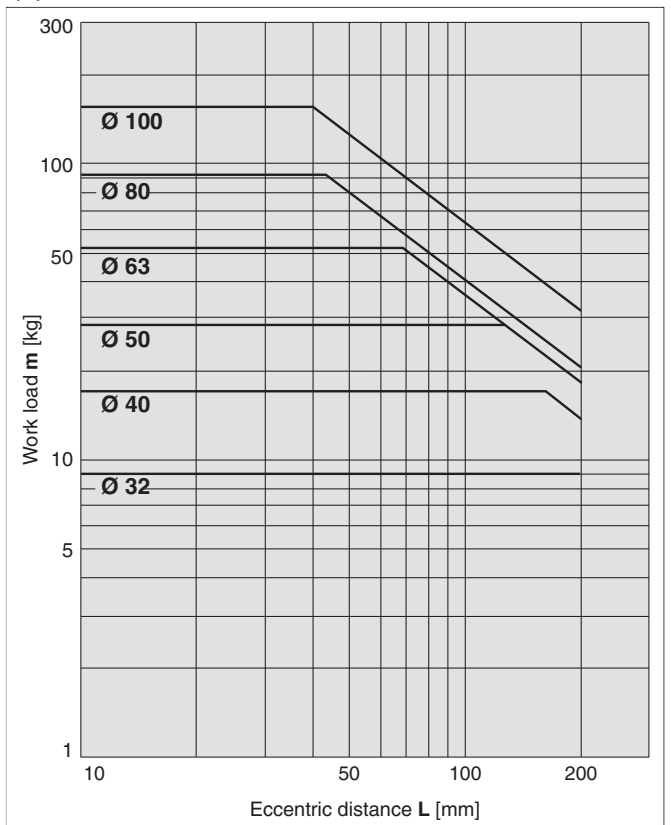

· Use the Guide Cylinder Selection Software, when the eccentric distance is 200 mm or more.

Basic Type  
**MGP-Z**

With Air Cushion  
**MGP-AZ**

With End Lock  
**MGP**

Heavy Duty Guide Rod Type  
**MGPS**

**Auto Switch**

**Made to Order**

# Series MGP

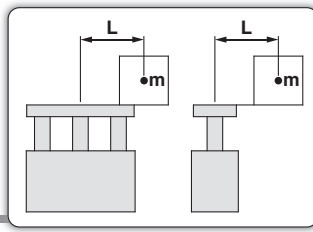

## Vertical Mounting **Ball Bushing**

— Operating pressure 0.4 MPa

### MGPL12 to 25, MGPA12 to 25

(9) 30 stroke or less,  $V = 400$  mm/s

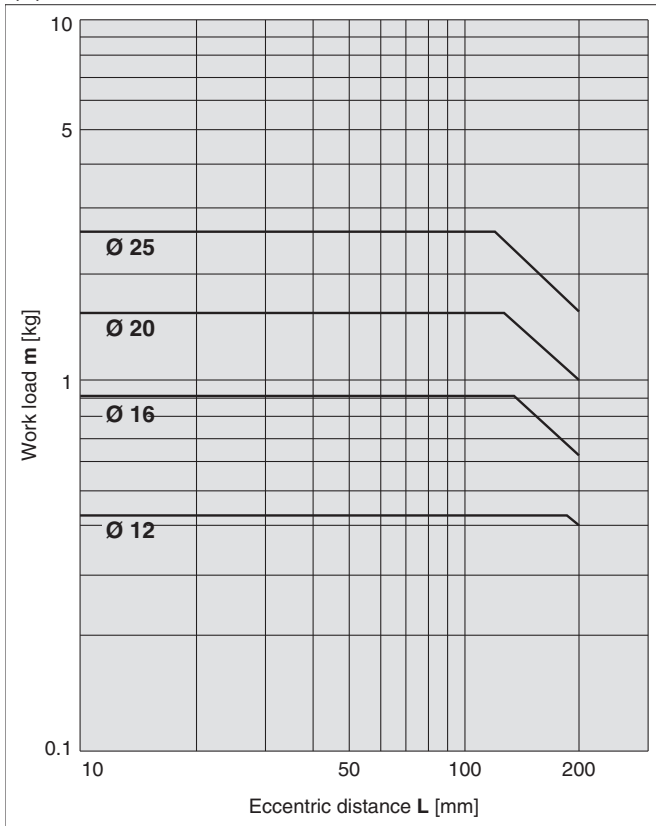

(10) Over 30 stroke,  $V = 400$  mm/s

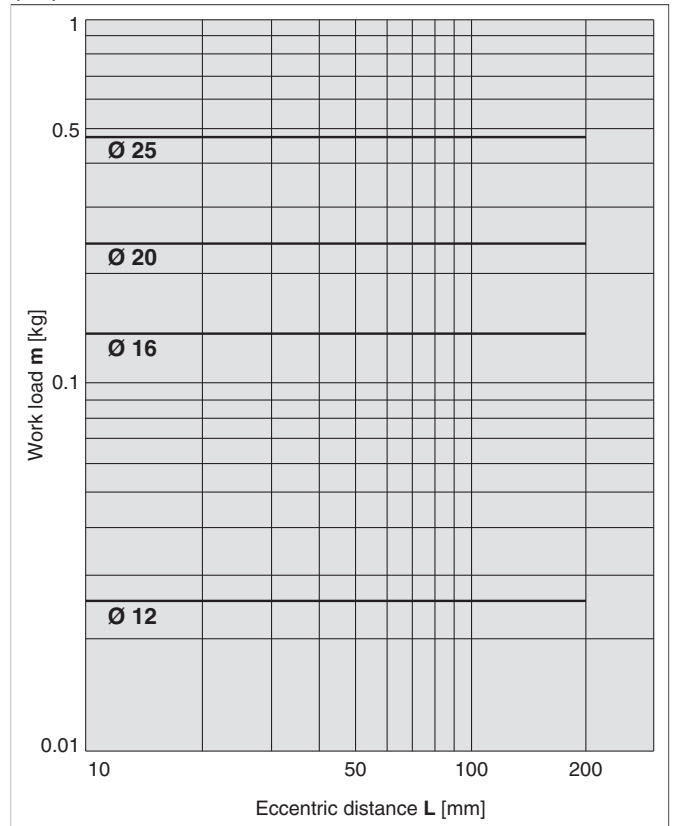

### MGPL32 to 100, MGPA32 to 100

(11) 50 stroke or less,  $V = 400$  mm/s

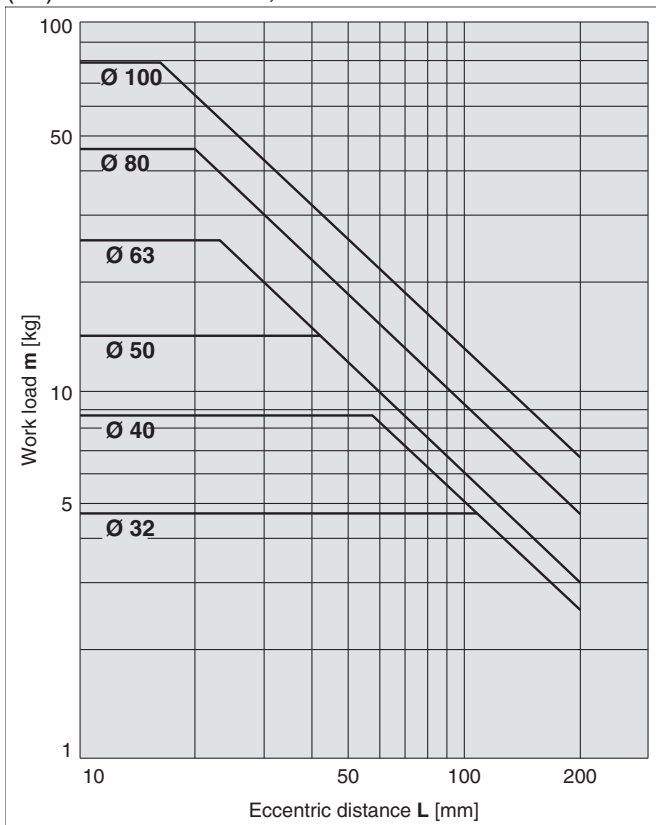

(12) Over 50 stroke,  $V = 400$  mm/s

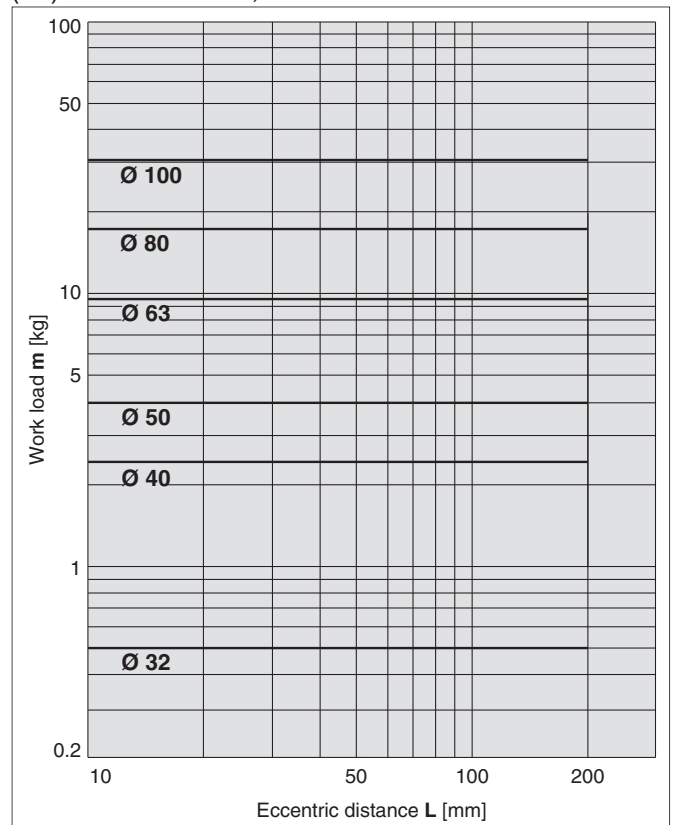

· Use the Guide Cylinder Selection Software, when the eccentric distance is 200 mm or more.

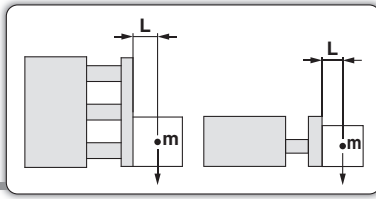

**Horizontal Mounting Slide Bearing**

**MGPM12 to 100**

(13) L = 50 mm, V = 200 mm/s or less

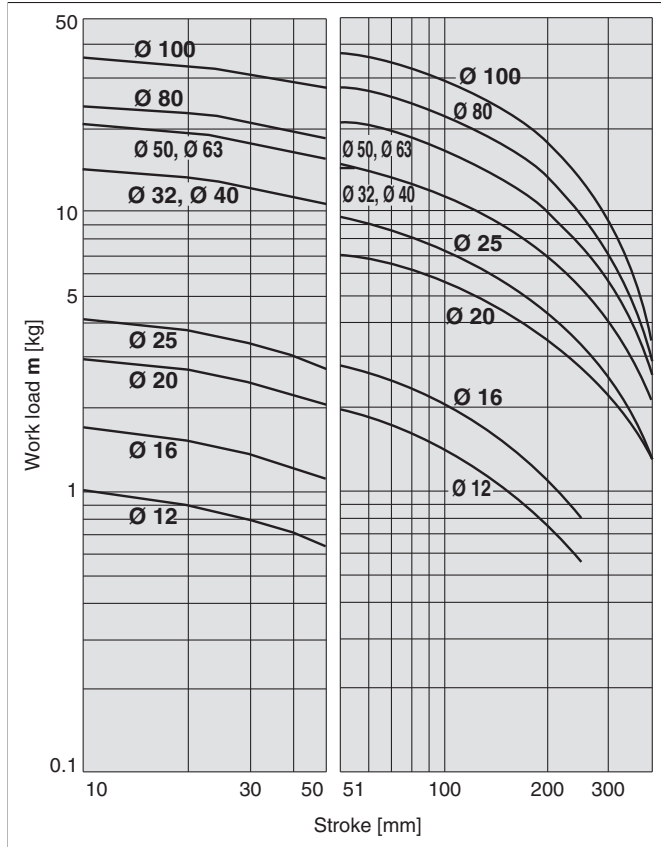

(14) L = 100 mm, V = 200 mm/s or less

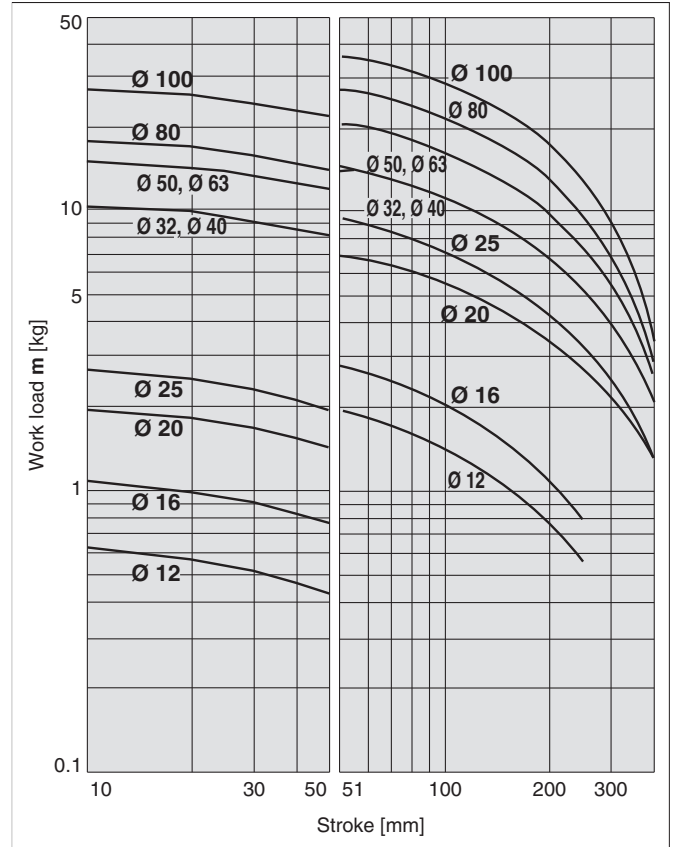

(15) L = 50 mm, V = 400 mm/s

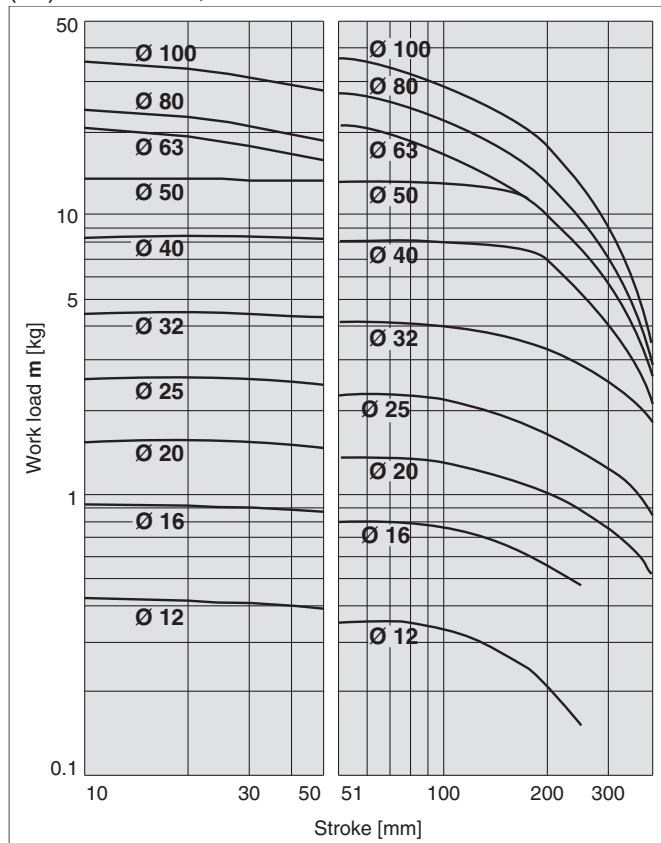

(16) L = 100 mm, V = 400 mm/s

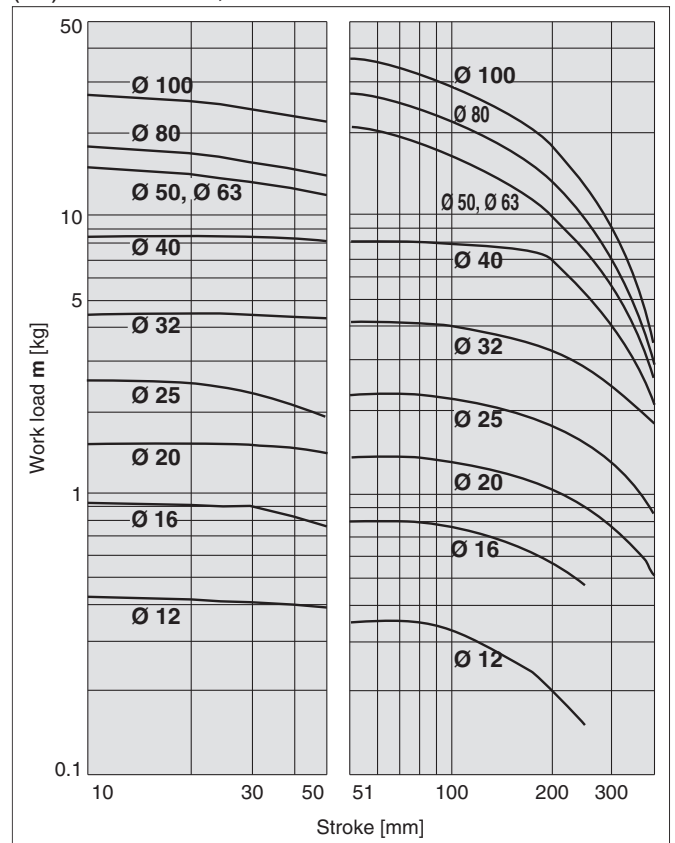

Basic Type  
**MGP-Z**

With Air Cushion  
**MGP-AZ**

With End Lock  
**MGP**

Heavy Duty Guide Rod Type  
**MGPS**

**Auto Switch**

**Made to Order**

# Series MGP

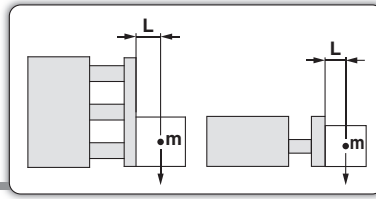

## Horizontal Mounting **Ball Bushing**

(17) L = 50 mm, V = 200 mm/s or less

(18) L = 100 mm, V = 200 mm/s or less

### MGPL12 to 25, MGPA12 to 25

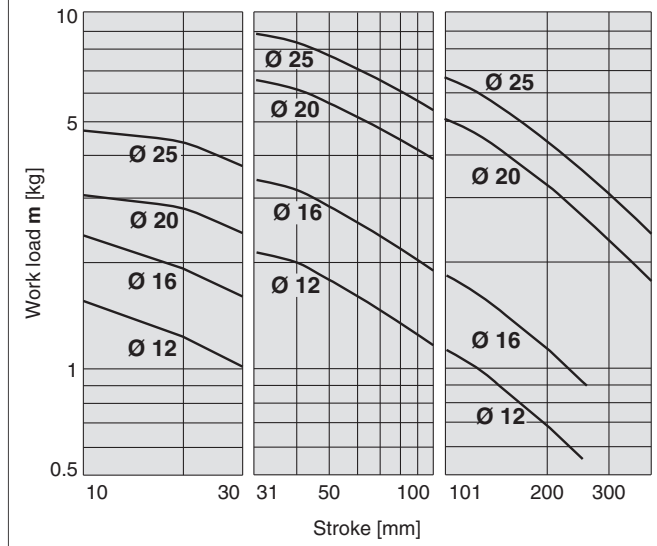

### MGPL12 to 25, MGPA12 to 25

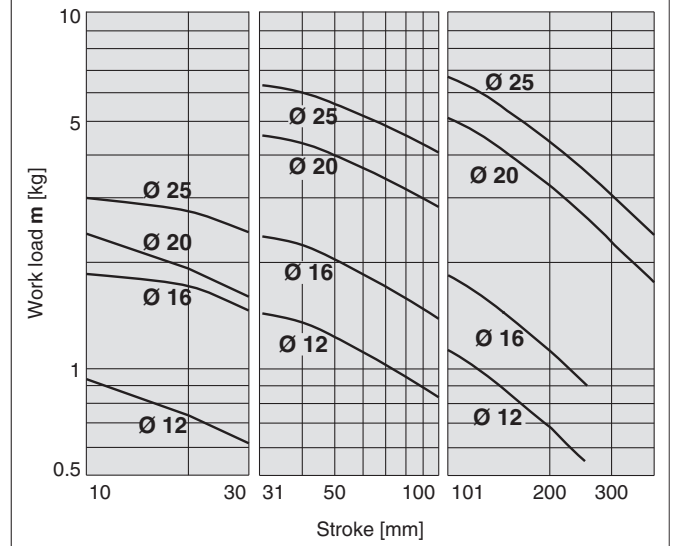

### MGPL32 to 63, MGPA32 to 63

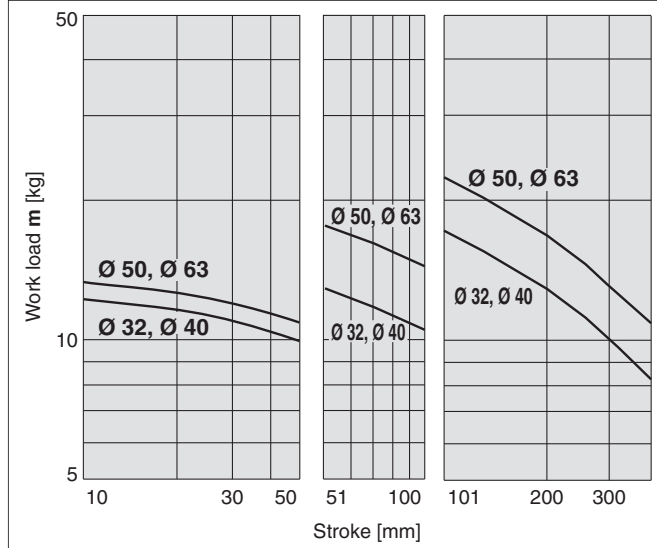

### MGPL32 to 63, MGPA32 to 63

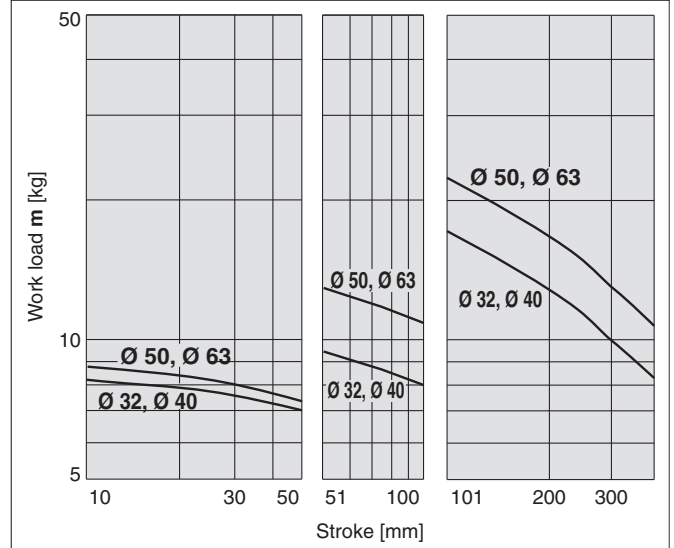

### MGPL80/100, MGPA80/100

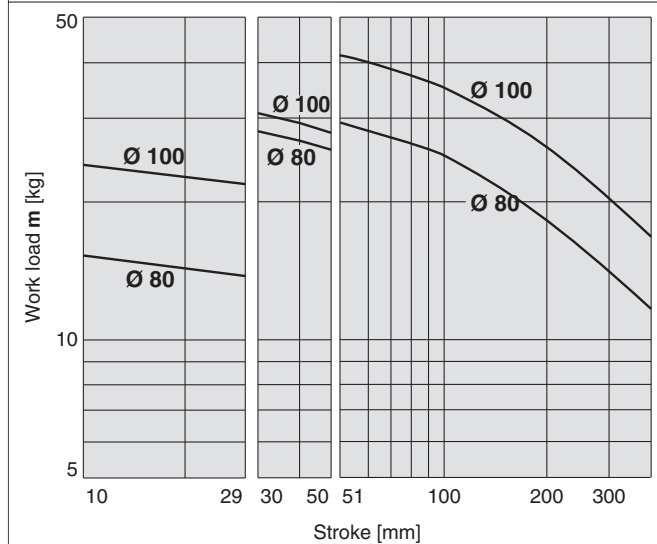

### MGPL80/100, MGPA80/100

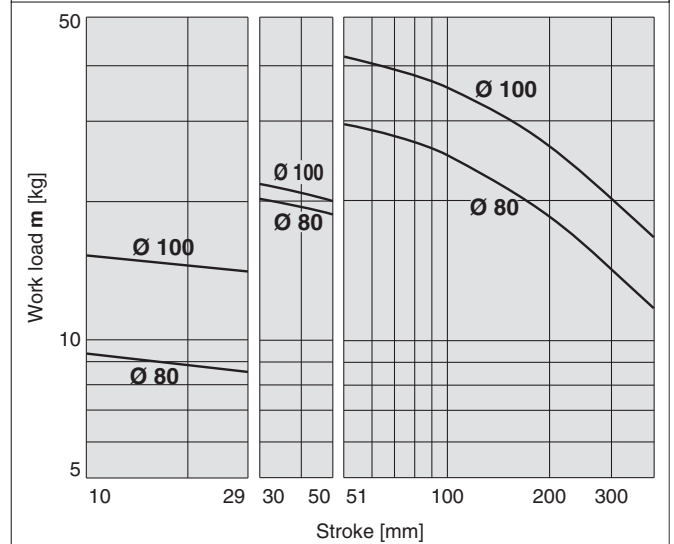

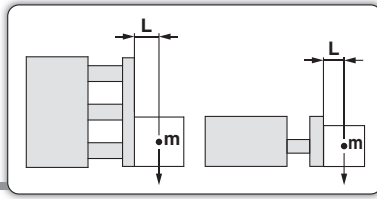

**Horizontal Mounting** **Ball Bushing**

(19) L = 50 mm, V = 400 mm/s

(20) L = 100 mm, V = 400 mm/s

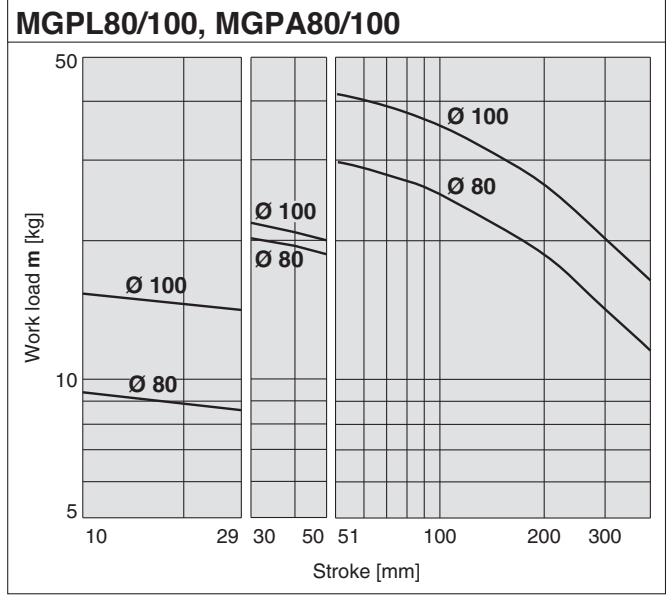
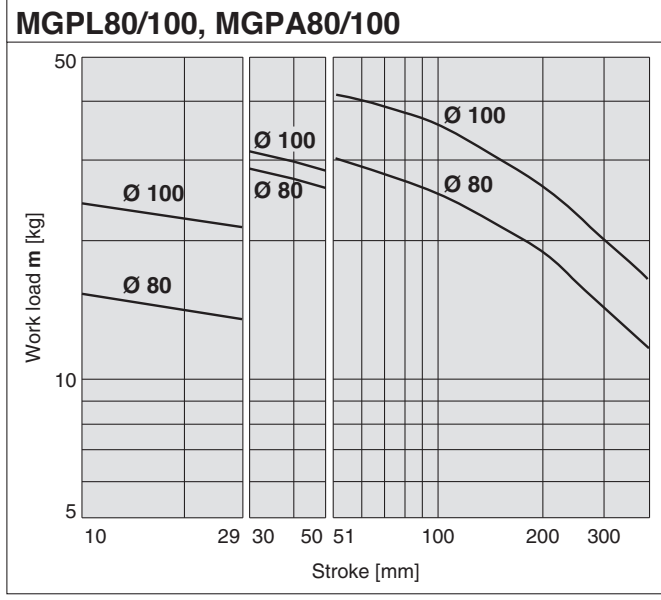
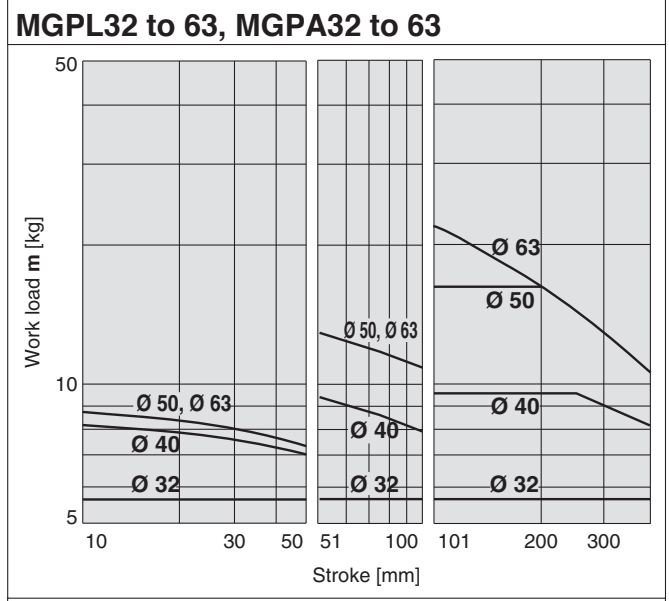
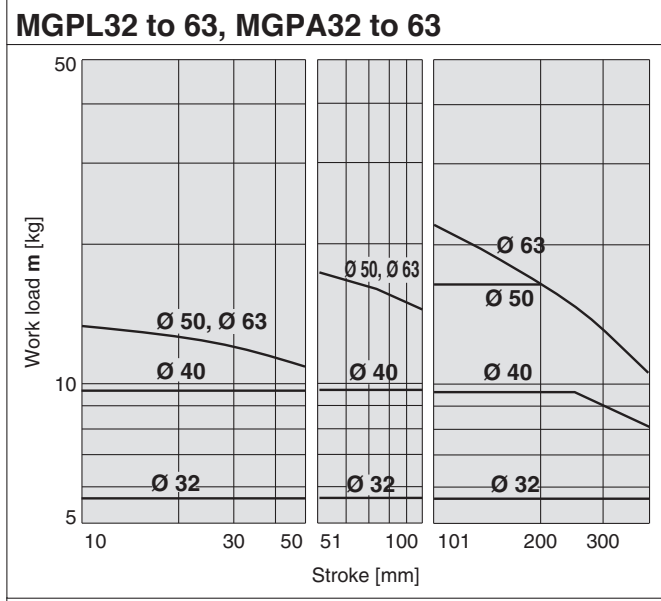
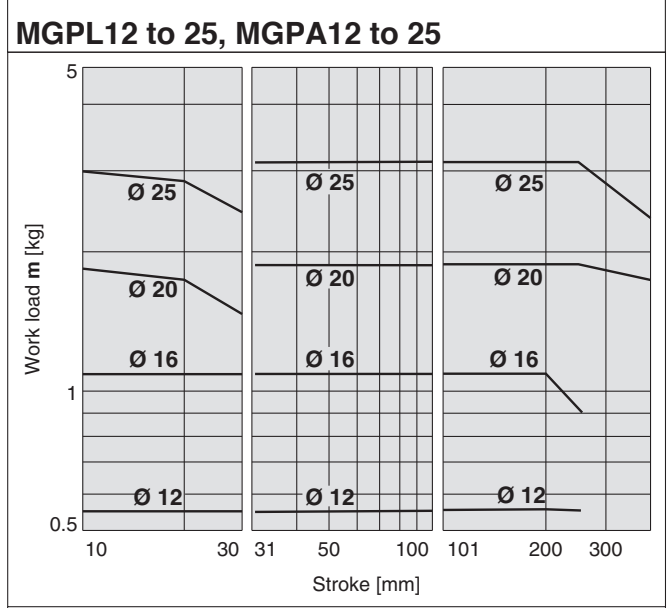
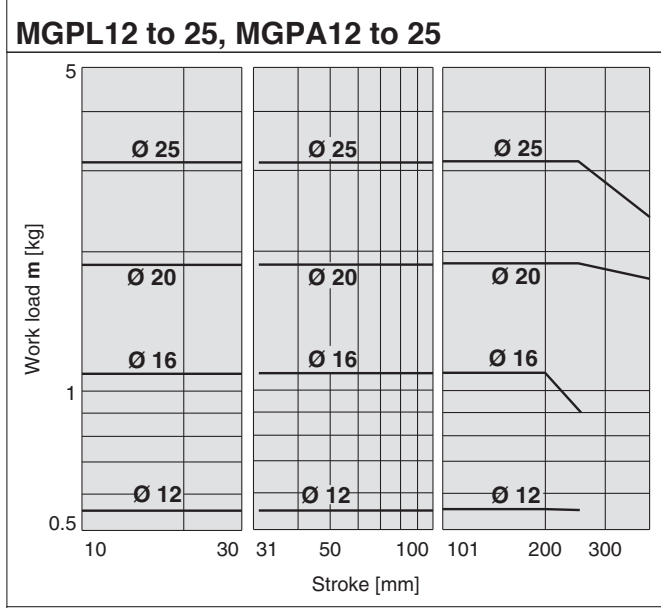

Basic Type  
**MGP-Z**

With Air Cushion  
**MGP-AZ**

With End Lock  
**MGP**

Heavy Duty Guide Rod Type  
**MGPS**

Auto Switch

Made to Order

# Series MGP

## Operating Range when Used as Stopper

### Bore Size: $\varnothing 12$ to $\varnothing 25$ /MGPM12 to 25 (Slide Bearing)

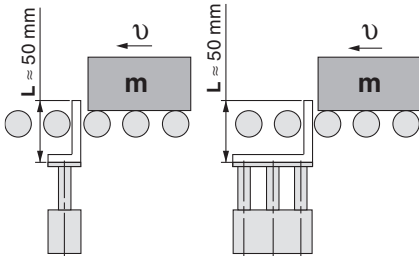

\*: When selecting a model with a longer **L** dimension, be sure to choose a bore size which is sufficiently large.

### ⚠ Caution

#### Caution on handling

1. When using as a stopper, select a model with 30 stroke or less.
2. The MGPL (Ball bushing) and the MGPA (High precision ball bushing) cannot be used as a stopper.

### MGPM12 to 25 (Slide Bearing)

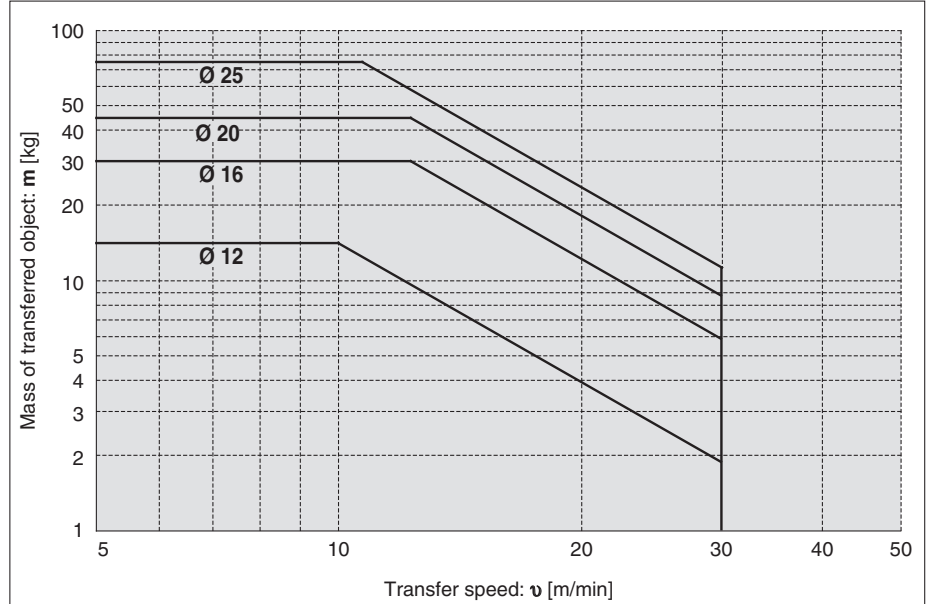

### Bore Size: $\varnothing 32$ to $\varnothing 100$ /MGPM32 to 100 (Slide Bearing)

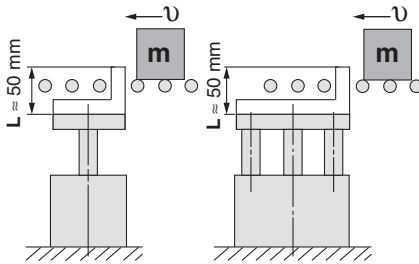

\*: When selecting a model with a longer **L** dimension, be sure to choose a bore size which is sufficiently large.

### ⚠ Caution

#### Caution on handling

1. When using as a stopper, select a model with 50 stroke or less.
2. The MGPL (Ball bushing) and the MGPA (High precision ball bushing) cannot be used as a stopper.

### MGPM32 to 100 (Slide Bearing)

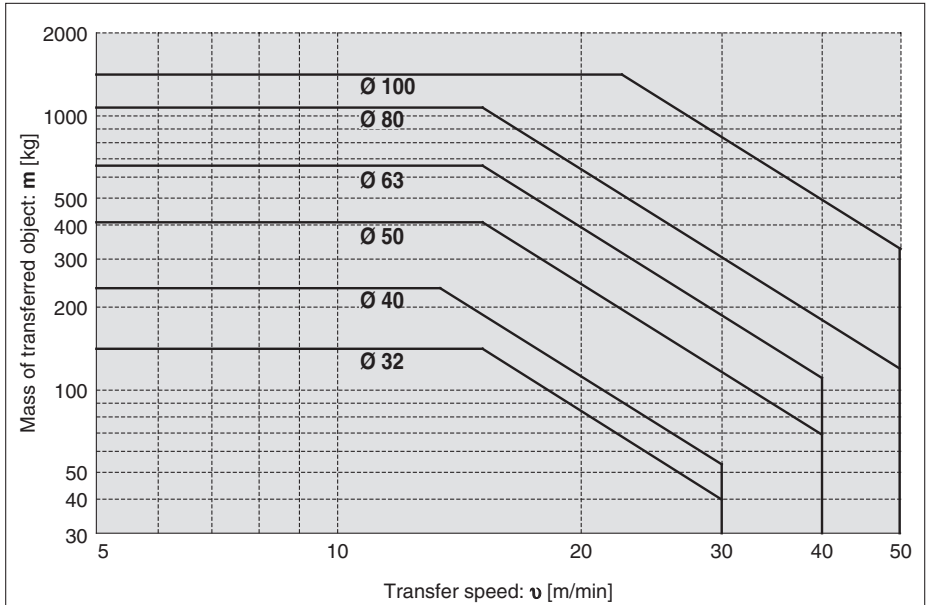

\*: Refer to graphs (13) and (15) if line pressure is applied by a roller conveyor after the workpiece is stopped.



## Construction/Series MGPM

### MGPM12 to 25

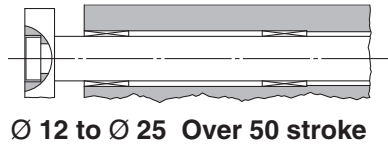
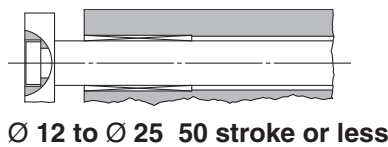
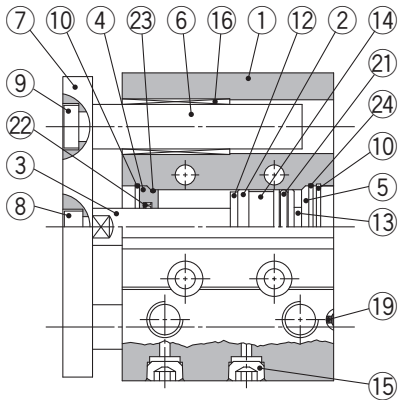

### MGPM32 to 100

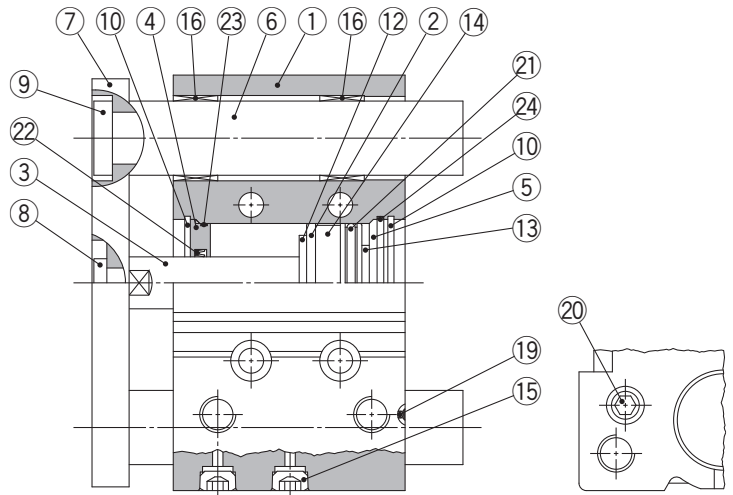

Ø 63 or more

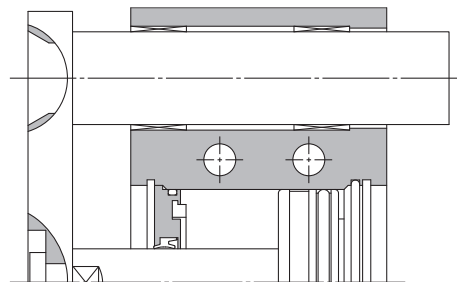

Ø 50 or more

### Component Parts

No.	Description	Material	Note
1	Body	Aluminium alloy	Hard anodised
2	Piston	Aluminium alloy	
3	Piston rod	Stainless steel	Ø 12 to Ø 25
		Carbon steel	Ø 32 to Ø 100   Hard chrome plating
4	Collar	Aluminium alloy	Chromated
5	Head cover	Aluminium alloy	Ø 12 to Ø 63   Chromated Ø 80, Ø 100   Painted
6	Guide rod	Carbon steel	Hard chrome plating
7	Plate	Carbon steel	Nickel plating
8	Plate mounting bolt	Carbon steel	Nickel plating
9	Guide bolt	Carbon steel	Nickel plating
10	Retaining ring	Carbon tool steel	Phosphate coated
11	Retaining ring	Carbon tool steel	Phosphate coated
12	Bumper A	Urethane	
13	Bumper B	Urethane	
14	Magnet	—	
15	Plug	Carbon steel	Ø 12, Ø 16   Nickel plating
	Hexagon socket head plug		Ø 20 to Ø 100
16	Slide bearing	Bearing alloy	

\*: A felt is not installed on the slide bearing.

### Component Parts

No.	Description	Material	Note
17	Ball bushing		
18	Spacer	Aluminium alloy	
19	Steel ball	Carbon steel	Ø 12 to Ø 50
20	Plug	Carbon steel	Ø 63 to Ø 100   Nickel plating
21*	Piston seal	NBR	
22*	Rod seal	NBR	
23*	Gasket A	NBR	
24*	Gasket B	NBR	

### Replacement Parts/Seal Kit

Bore size [mm]	Kit no.	Contents	Bore size [mm]	Kit no.	Contents
12	MGP12-Z-PS	Set of nos. above	40	MGP40-Z-PS	Set of nos. above
16	MGP16-Z-PS		50	MGP50-Z-PS	
20	MGP20-Z-PS		63	MGP63-Z-PS	
25	MGP25-Z-PS		80	MGP80-Z-PS	
32	MGP32-Z-PS		100	MGP100-Z-PS	

\*: Seal kit includes ⑳ to ㉔. Order the seal kit, based on each bore size.

\*: Since the seal kit does not include a grease pack, order it separately.

**Grease pack part number: GR-S-010 (10 g)**

\*: For Made to Order, refer to page 91.

Basic Type  
**MGP-Z**

With Air Cushion  
**MGP-AZ**

With End Lock  
**MGP**

Heavy Duty Guide Rod Type  
**MGPS**

Auto Switch

Made to Order

# Series MGP

## Construction/Series MGPL, Series MGPA

MGPL12 to 25  
MGPA12 to 25

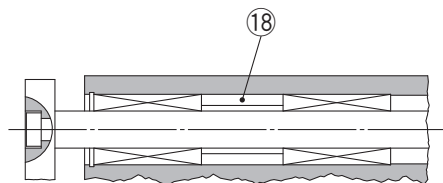
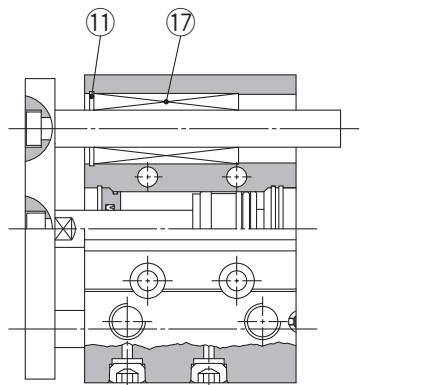

Ø 12 to Ø 25 Over 100 stroke

MGPL32 to 100  
MGPA32 to 100

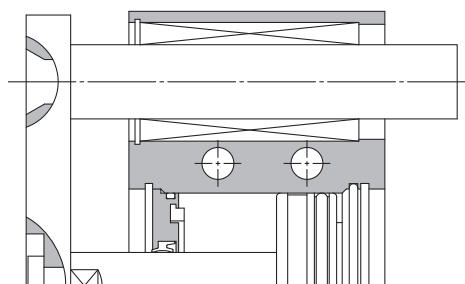
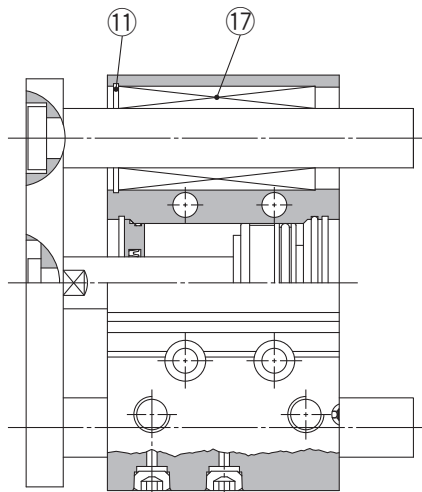

Ø 50 or more

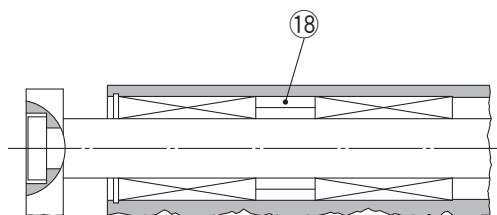

Ø 32 to Ø 63 Over 100 stroke  
Ø 80, Ø 100 Over 200 stroke

**Ø 12 to Ø 25/MGPM, MGPL, MGPA**

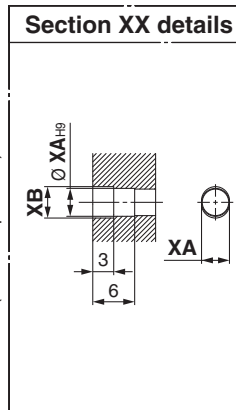
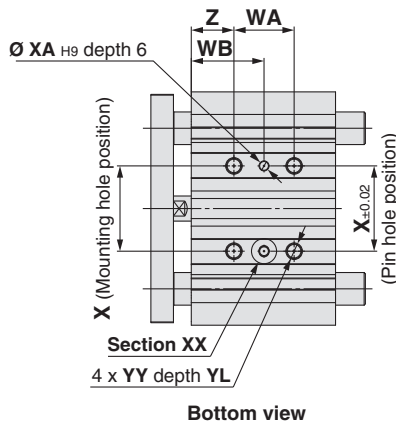
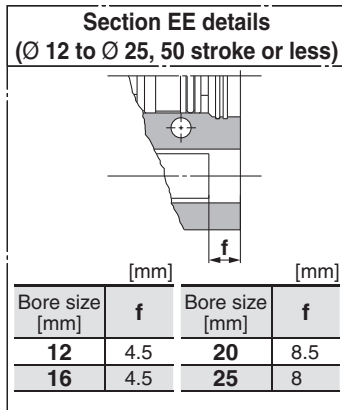

**T-slot dimensions**

Bore size [mm]	a [mm]	b [mm]	c [mm]	d [mm]	e [mm]
12	4.4	7.4	3.7	2	6.2
16	4.4	7.4	3.7	2.5	6.7
20	5.4	8.4	4.5	2.8	7.8
25	5.4	8.4	4.5	3	8.2

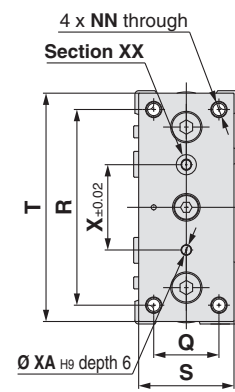
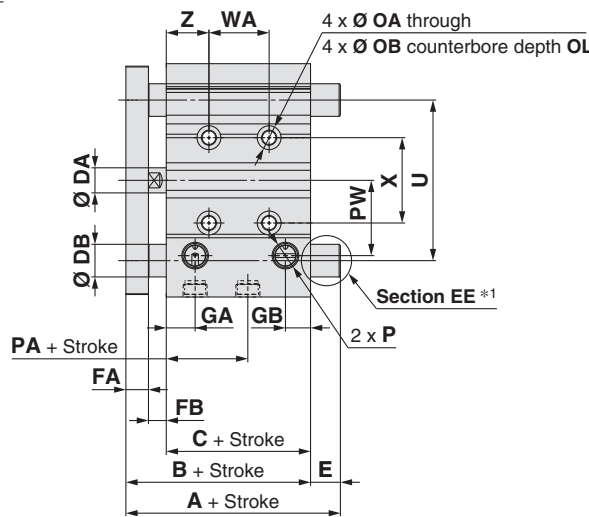
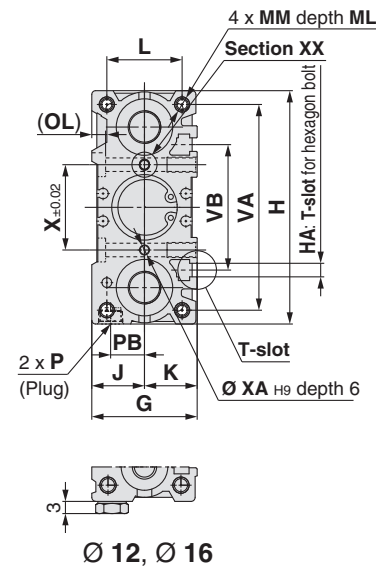

- \*1: Refer to Section EE details for the shape of Ø 12 to Ø 25 with stroke of 50 or less.
- \*: The use of a slot (width XA, length XB, depth 3) allows for a relaxed pin pitch tolerance, with the pin hole (Ø XAH9, depth 6) as the reference, without affecting mounting accuracy.
- \*: For intermediate strokes other than standard strokes, refer to Manufacture of Intermediate Strokes on page 10.
- \*: For bore size Ø 12 and Ø 16, only M5 x 0.8 port is available.
- \*: For bore size Ø 20 or more, choice of Rc, NPT, G port is available. (Refer to page 9.)

**MGPM, MGPL, MGPA Common Dimensions**

Bore size [mm]	Standard stroke [mm]	B	C	DA	FA	FB	G	GA	GB	H	HA	J	K	L	MM	ML	NN	OA	OB	OL	P		
																					—	TN	TF
12	10, 20, 30, 40, 50, 75, 100	42	29	6	7	6	26	10	7	58	M4	13	13	18	M4 x 0.7	10	M4 x 0.7	4.3	8	4.5	M5 x 0.8	—	—
16	125, 150, 175, 200, 250	46	33	8	7	6	30	10.5	7.5	64	M4	15	15	22	M5 x 0.8	12	M5 x 0.8	4.3	8	4.5	M5 x 0.8	—	—
20	20, 30, 40, 50, 75, 100, 125, 150	53	37	10	8	8	36	11.5	9	83	M5	18	18	24	M5 x 0.8	13	M5 x 0.8	5.4	9.5	5.5	Rc 1/8	NPT 1/8	G 1/8
25	175, 200, 250, 300, 350, 400	53.5	37.5	10	9	7	42	11.5	10	93	M5	21	21	30	M6 x 1.0	15	M6 x 1.0	5.4	9.5	5.5	Rc 1/8	NPT 1/8	G 1/8

Bore size [mm]	PA	PB	PW	Q	R	S	T	U	VA	VB	WA				WB				X	XA	XB	YY	YL	Z		
											30 st or less	Over 30 st or less	Over 100 st or less	Over 200 st or less	30 st or less	Over 30 st or less	Over 100 st or less	Over 200 st or less								
12	13	8	18	14	48	22	56	41	50	37	20	40	110	200	—	15	25	60	105	—	23	3	3.5	M5 x 0.8	10	5
16	14.5	10	19	16	54	25	62	46	56	38	24	44	110	200	—	17	27	60	105	—	24	3	3.5	M5 x 0.8	10	5
20	13.5	10.5	25	18	70	30	81	54	72	44	24	44	120	200	300	29	39	77	117	167	28	3	3.5	M6 x 1.0	12	17
25	12.5	13.5	30	26	78	38	91	64	82	50	24	44	120	200	300	29	39	77	117	167	34	4	4.5	M6 x 1.0	12	17

**MGPM (Slide bearing) A, DB, E Dimensions**

Bore size [mm]	A				DB	E			
	50 st or less	Over 50 st or less	Over 100 st or less	Over 200 st		50 st or less	Over 50 st or less	Over 100 st or less	Over 200 st
12	42	60.5	82.5	82.5	8	0	18.5	40.5	40.5
16	46	64.5	92.5	92.5	10	0	18.5	46.5	46.5
20	53	77.5	77.5	110	12	0	24.5	24.5	57
25	53.5	77.5	77.5	109.5	16	0	24	24	56

**MGPL (Ball bushing)**

**MGPA (High precision ball bushing) A, DB, E Dimensions**

Bore size [mm]	A				DB	E			
	30 st or less	Over 30 st or less	Over 100 st or less	Over 200 st		30 st or less	Over 30 st or less	Over 100 st or less	Over 200 st
12	43	55	84.5	84.5	6	1	13	42.5	42.5
16	49	65	94.5	94.5	8	3	19	48.5	48.5
20	59	76	100	117.5	10	6	23	47	64.5
25	65.5	81.5	100.5	117.5	13	12	28	47	64

Basic Type  
**MGP-Z**

With Air Cushion  
**MGP-AZ**

With End Lock  
**MGP**

Heavy Duty Guide Rod Type  
**MGPS**

Auto Switch

Made to Order

# Series MGP

## Ø 32 to Ø 63/MGPM, MGPL, MGPA

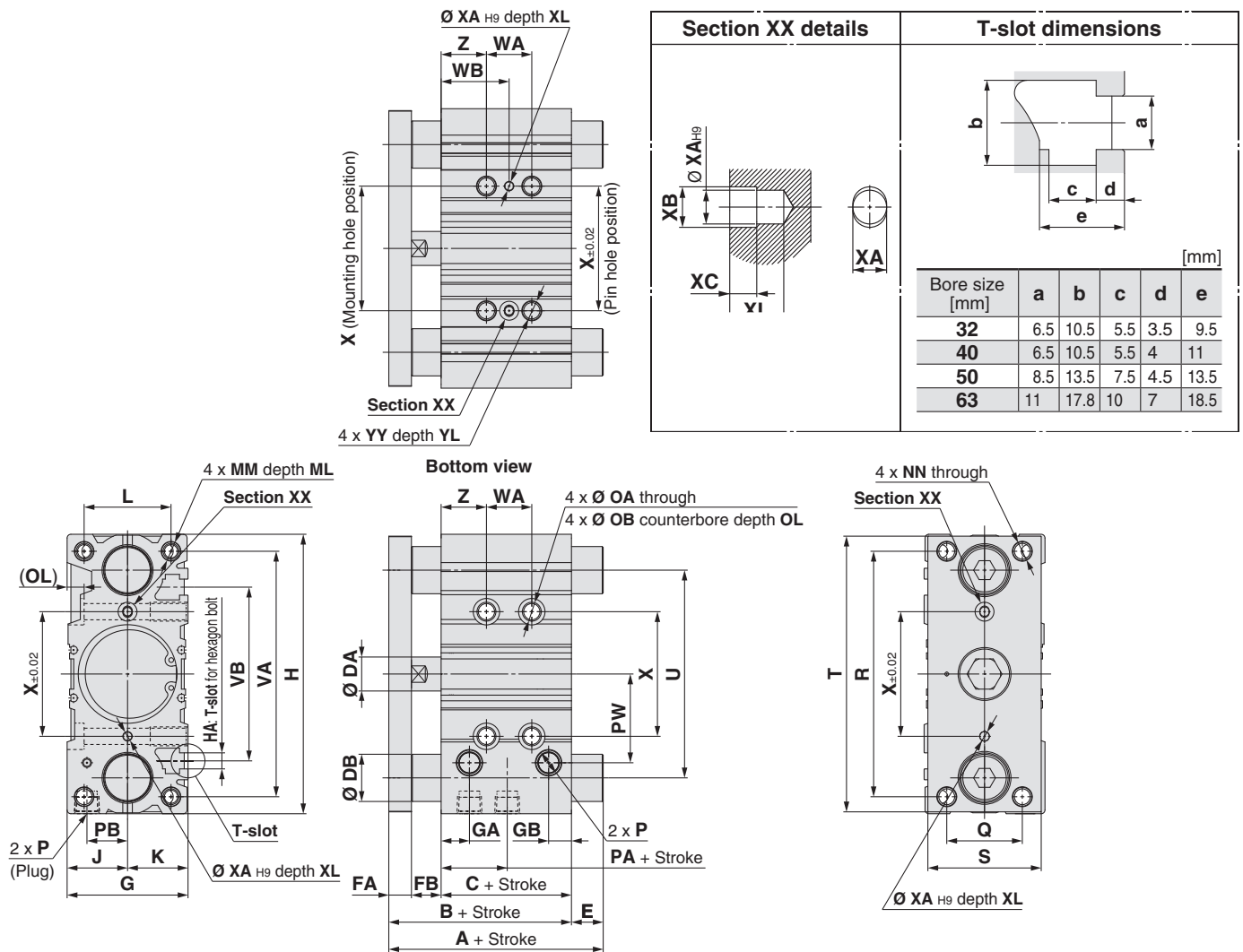

- \*: The use of a slot (width XA, length XB, depth XC) allows for a relaxed pin pitch tolerance, with the pin hole (Ø XAH9, depth XL) as the reference, without affecting mounting accuracy.
- \*: For intermediate strokes other than standard strokes, refer to Manufacture of Intermediate Strokes on page 10.
- \*: Choice of Rc, NPT, G port is available. (Refer to page 9.)

### MGPM, MGPL, MGPA Common Dimensions

Bore size [mm]	Standard stroke [mm]	B	C	DA	FA	FB	G	GA	GB	H	HA	J	K	L	MM	ML	NN	OA	OB	OL	P		
																					—	TN	TF
32	25, 50, 75	59.5	37.5	14	10	12	48	12	9	112	M6	24	24	34	M8 x 1.25	20	M8 x 1.25	6.7	11	7.5	Rc 1/8	NPT 1/8	G 1/8
40	100, 125, 150	66	44	14	10	12	54	15	12	120	M6	27	27	40	M8 x 1.25	20	M8 x 1.25	6.7	11	7.5	Rc 1/8	NPT 1/8	G 1/8
50	175, 200, 250	72	44	18	12	16	64	15	12	148	M8	32	32	46	M10 x 1.5	22	M10 x 1.5	8.6	14	9	Rc 1/4	NPT 1/4	G 1/4
63	300, 350, 400	77	49	18	12	16	78	15.5	13.5	162	M10	39	39	58	M10 x 1.5	22	M10 x 1.5	8.6	—	9	Rc 1/4	NPT 1/4	G 1/4

Bore size [mm]	PA	PB	PW	Q	R	S	T	U	VA	VB	WA					WB					X	XA	XB	XC	XL	YY	YL	Z
											25 st or less	Over 25 st or less	Over 100 st or less	Over 200 st or less	Over 300 st or less	25 st or less	Over 25 st or less	Over 100 st or less	Over 200 st or less	Over 300 st or less								
32	6.5	16	35.5	30	96	44	110	78	98	63	24	48	124	200	300	33	45	83	121	171	42	4	4.5	3	6	M8 x 1.25	16	21
40	13	18	39.5	30	104	44	118	86	106	72	24	48	124	200	300	34	46	84	122	172	50	4	4.5	3	6	M8 x 1.25	16	22
50	9	21.5	47	40	130	60	146	110	130	92	24	48	124	200	300	36	48	86	124	174	66	5	6	4	8	M10 x 1.5	20	24
63	13	28	58	50	130	70	158	124	142	110	28	52	128	200	300	38	50	88	124	174	80	5	6	4	8	M10 x 1.5	20	24

### MGPM (Slide bearing) A, DB, E Dimensions

Bore size [mm]	A			DB	E		
	50 st or less	Over 50 st or less	Over 200 st		50 st or less	Over 50 st or less	Over 200 st
32	75	93.5	129.5	20	15.5	34	70
40	75	93.5	129.5	20	9	27.5	63.5
50	88.5	109.5	150.5	25	16.5	37.5	78.5
63	88.5	109.5	150.5	25	11.5	32.5	73.5

### MGPL (Ball bushing)

### MGPA (High precision ball bushing) A, DB, E Dimensions

Bore size [mm]	A				DB	E			
	50 st or less	Over 50 st or less	Over 100 st or less	Over 200 st		50 st or less	Over 50 st or less	Over 100 st or less	Over 200 st
32	79.5	96.5	116.5	138.5	16	20	37	57	79
40	79.5	96.5	116.5	138.5	16	13.5	30.5	50.5	72.5
50	91.5	112.5	132.5	159.5	20	19.5	40.5	60.5	87.5
63	91.5	112.5	132.5	159.5	20	14.5	35.5	55.5	82.5

**Ø 80, Ø 100/MGPM, MGPL, MGPA**

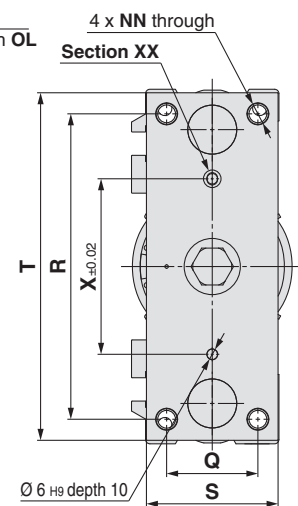
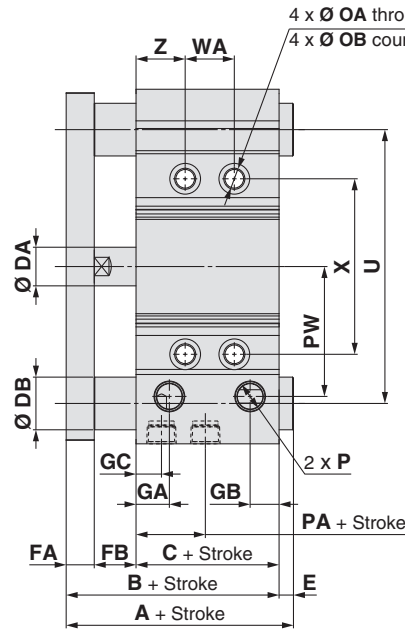
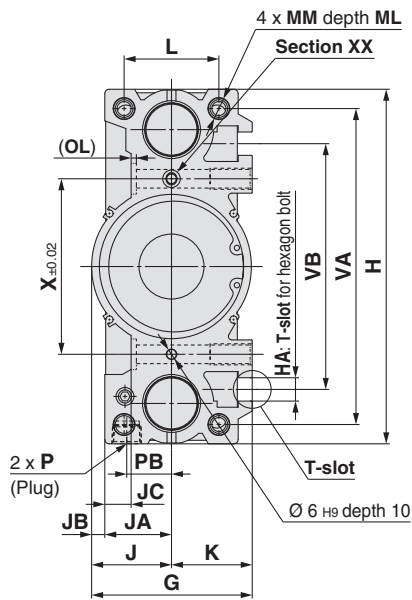
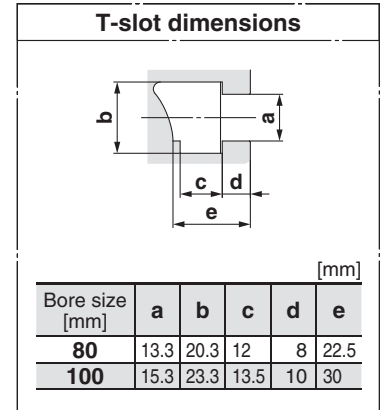
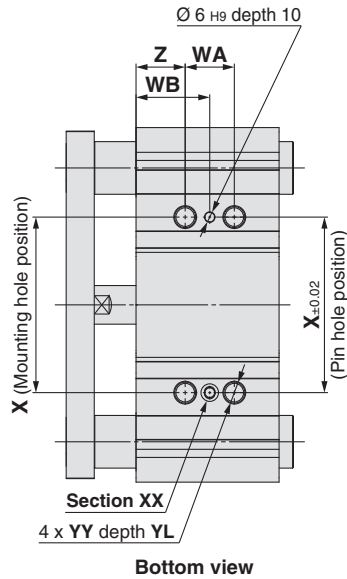
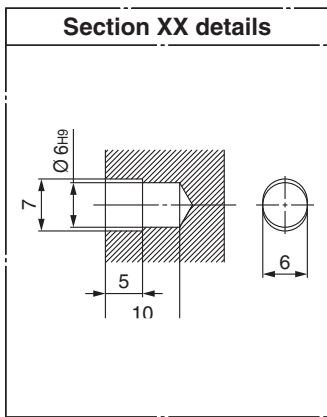

- \*: The use of a slot (width X6, length 7, depth 5) allows for a relaxed pin pitch tolerance, with the pin hole (Ø 6H9, depth 10) as the reference, without affecting mounting accuracy.
- \*: For intermediate strokes other than standard strokes, refer to Manufacture of Intermediate Strokes on page 10.
- \*: Choice of Rc, NPT, G port is available. (Refer to page 9.)

**MGPM, MGPL, MGPA Common Dimensions**

Bore size [mm]	Standard stroke [mm]	B	C	DA	FA	FB	G	GA	GB	GC	H	HA	J	JA	JB	JC	K	L	MM	ML	NN	OA	OB	OL	P		
																									—	TN	TF
80	25, 50, 75, 100	96.5	56.5	22	16	24	91.5	19	16.5	14.5	202	M12	45.5	38	7.5	15	46	54	M12 x 1.75	25	M12 x 1.75	10.6	17.5	3	Rc 3/8	NPT 3/8	G 3/8
	125, 150, 175, 200	116	66	26	19	31	111.5	22.5	20.5	18	240	M14	55.5	45	10.5	10	56	62	M14 x 2.0	31	M14 x 2.0	12.5	20	8	Rc 3/8	NPT 3/8	G 3/8
100	250, 300, 350, 400	116	66	26	19	31	111.5	22.5	20.5	18	240	M14	55.5	45	10.5	10	56	62	M14 x 2.0	31	M14 x 2.0	12.5	20	8	Rc 3/8	NPT 3/8	G 3/8

Bore size [mm]	PA	PB	PW	Q	R	S	T	U	VA	VB	WA					WB					X	YY	YL	Z
											25 st or less	Over 25 st 100 st or less	Over 100 st 200 st or less	Over 200 st 300 st or less	Over 300 st	25 st or less	Over 25 st 100 st or less	Over 100 st 200 st or less	Over 200 st 300 st or less	Over 300 st				
80	14.5	25.5	74	52	174	75	198	156	180	140	28	52	128	200	300	42	54	92	128	178	100	M12 x 1.75	24	28
100	17.5	32.5	89	64	210	90	236	188	210	166	48	72	148	220	320	35	47	85	121	171	124	M14 x 2.0	28	11

**MGPM (Slide bearing) A, DB, E Dimensions**

Bore size [mm]	A			DB	E		
	50 st or less	Over 50 st 200 st or less	Over 200 st		50 st or less	Over 50 st 200 st or less	Over 200 st
80	104.5	131.5	180.5	30	8	35	84
100	126.5	151.5	190.5	36	10.5	35.5	74.5

**MGPL (Ball bushing)**

**MGPA (High precision ball bushing) A, DB, E Dimensions**

Bore size [mm]	A				DB	E			
	25 st or less	Over 25 st 50 st or less	Over 50 st 200 st or less	Over 200 st		25 st or less	Over 25 st 50 st or less	Over 50 st 200 st or less	Over 200 st
80	104.5	128.5	158.5	191.5	25	8	32	62	95
100	119.5	145.5	178.5	201.5	30	3.5	29.5	62.5	85.5

Basic Type  
**MGP-Z**

With Air Cushion  
**MGP-AZ**

With End Lock  
**MGP**

Heavy Duty Guide Rod Type  
**MGPS**

Auto Switch

Made to Order

# Compact Guide Cylinder With Air Cushion

# Series MGP

Ø 16, Ø 20, Ø 25, Ø 32, Ø 40, Ø 50, Ø 63, Ø 80, Ø 100

## How to Order

**MGP M 32 - 50 AZ - M9BW -**

**Compact Guide Cylinder**

**Bearing type**

<b>M</b>	Slide bearing
<b>L</b>	Ball bushing
<b>A</b>	High precision ball bushing

**Bore size**

<b>16</b>	16 mm	<b>50</b>	50 mm
<b>20</b>	20 mm	<b>63</b>	63 mm
<b>25</b>	25 mm	<b>80</b>	80 mm
<b>32</b>	32 mm	<b>100</b>	100 mm
<b>40</b>	40 mm		

**Port thread type**

—	M5 x 0.8
	Rc
<b>TN</b>	NPT
<b>TF</b>	G

\*: For bore size 16, only M5 x 0.8 is available.

**With air cushion**

**Cylinder stroke [mm]**  
Refer to Standard Strokes on page 30.

**Auto switch**

—	Without auto switch (Built-in magnet)
---	---------------------------------------

\*: For applicable auto switches, refer to the table below.

**Number of auto switches**

—	2 pcs.
<b>S</b>	1 pc.
<b>n</b>	n pcs.

**Made to Order**  
For details, refer to page 30.

## Applicable Auto Switches/Refer to the Auto Switch Guide for further information on auto switches.

Type	Special function	Electrical entry	Indicator/light	Wiring (Output)	Load voltage		Auto switch model		Lead wire length [m]				Pre-wired connector	Applicable load		
					DC	AC	Perpendicular	In-line	0.5 (—)	1 (M)	3 (L)	5 (Z)				
Solid state auto switch	—	Grommet	Yes	3-wire (NPN)	24 V	5 V, 12 V	—	<b>M9NV</b>	<b>M9N</b>	●	●	●	○	○	IC circuit	Relay, PLC
				3-wire (PNP)				<b>M9PV</b>	<b>M9P</b>	●	●	●	○	○		
				2-wire				<b>M9BV</b>	<b>M9B</b>	●	●	●	○	○		
				3-wire (NPN)				<b>M9NWV</b>	<b>M9NW</b>	●	●	●	○	○		
	Diagnostic indication (2-colour indication)			3-wire (PNP)	5 V, 12 V	—	<b>M9PWV</b>	<b>M9PW</b>	●	●	●	○	○	○	IC circuit	
				2-wire	12 V	—	<b>M9BWV</b>	<b>M9BW</b>	●	●	●	○	○	○	—	
	Water resistant (2-colour indication)			3-wire (NPN)	5 V, 12 V	—	<b>M9NAV</b> *1	<b>M9NA</b> *1	○	○	●	○	○	○	IC circuit	
				3-wire (PNP)	5 V, 12 V	—	<b>M9PAV</b> *1	<b>M9PA</b> *1	○	○	●	○	○	○	IC circuit	
	Magnetic field resistant (2-colour indication)			2-wire	12 V	—	<b>M9BAV</b> *1	<b>M9BA</b> *1	○	○	●	○	○	○	—	
				2-wire (Non-polar)	—	—	—	<b>P3DWA</b> *2	●	—	●	●	○	○	—	
Reed auto switch	—	Grommet	Yes	3-wire (NPN equivalent)	—	5 V	—	<b>A96V</b>	<b>A96</b>	●	—	●	—	—	IC circuit	—
				2-wire	24 V	12 V	100 V	<b>A93V</b> *3	<b>A93</b>	●	●	●	●	—	—	Relay, PLC
							100 V or less	<b>A90V</b>	<b>A90</b>	●	—	●	—	—	—	IC circuit

\*1: Water resistant type auto switches are mountable on the above models, but in such case SMC cannot guarantee water resistance.

A water resistant type cylinder is recommended for use in an environment which requires water resistance.

However, please contact SMC for water resistant products of Ø 12 and Ø 16.

\*2: The D-P3DWA□ is mountable on bore size Ø 25 to Ø 100.

\*3: 1 m type lead wire is only applicable to the D-A93.

\*: Lead wire length symbols: 0.5 m..... (Example) M9NV  
 1 m..... M (Example) M9NWM  
 3 m..... L (Example) M9NWL  
 5 m..... Z (Example) M9NWX

\*: Solid state auto switches marked with "○" are produced upon receipt of order.

\*: Other than the auto switches listed above, the D-P4DW type can be mounted. Refer to page 66 for details.

\*: For details about auto switches with pre-wired connector, refer to the Auto Switch Guide.

For the D-P3DWA□, refer to the Auto Switch Guide.

\*: Auto switches are shipped together, (but not assembled).

# Compact Guide Cylinder With Air Cushion Series MGP

## Specifications

Bore size [mm]	16	20	25	32	40	50	63	80	100
<b>Action</b>	Double acting								
<b>Fluid</b>	Air								
<b>Proof pressure</b>	1.5 MPa								
<b>Maximum operating pressure</b>	1.0 MPa								
<b>Minimum operating pressure</b>	0.15 MPa	0.12 MPa							
<b>Ambient and fluid temperature</b>	-10 to 60 °C (No freezing)								
<b>Piston speed *1</b>	50 to 500 mm/s							50 to 400 mm/s	
<b>Cushion</b>	Air cushion on both ends (Without bumper)								
<b>Lubrication</b>	Not required (Non-lube)								
<b>Stroke length tolerance</b>	$^{+1.5}_0$ mm								

\*1: Maximum speed with no load. Depending on the operating conditions, the piston speed may not be satisfied. Make a model selection, considering a load according to the graph on pages 33 to 39.

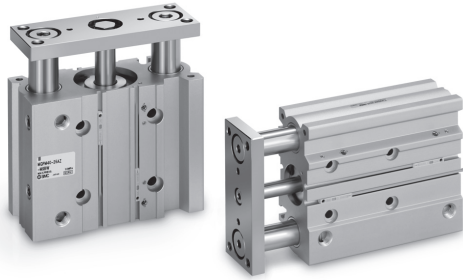

**Symbol**  
Air cushion

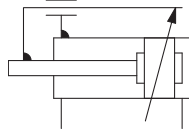

**Made to Order**  
(For details, refer to pages 72 to 89.)

Symbol	Specifications
-XA□	Change of guide rod end shape
-XC19	Intermediate stroke (Spacer type)
-XC79	Tapped hole, drilled hole, pinned hole machined additionally
-XC85	Grease for food processing equipment
-X867	Side porting type (Plug location changed)

Refer to pages 63 to 67 for cylinders with auto switches.

- Auto switch proper mounting position (detection at stroke end) and its mounting height
- Minimum stroke for auto switch mounting
- Operating range
- Auto switch mounting brackets/Part no.
- Auto Switch Mounting

## Standard Strokes

Bore size [mm]	Standard stroke [mm]
16	25, 50, 75, 100, 125, 150, 175, 200, 250
20 to 63	25, 50, 75, 100, 125, 150, 175, 200, 250, 300, 350, 400
80, 100	50, 75, 100, 125, 150, 175, 200, 250, 300, 350, 400

## Manufacture of Intermediate Strokes

Description	Intermediate strokes in 1 mm increments are available by replacing collars of a standard stroke cylinder. Minimum manufacturable stroke    Ø 16 to Ø 63: 15 mm Ø 80, Ø 100: 20 mm	
	Select a rubber bumper type, because the cushion effect is not obtainable for less than this stroke.	
Model no.	Add "-XC19" to the end of standard part number.	
Applicable stroke [mm]	Ø 16	15 to 249
	Ø 20 to Ø 63	15 to 399
	Ø 80, Ø 100	20 to 399
Example	Part no.: MGPM20-35AZ-XC19 A collar 15 mm in width is installed in the MGPM20-50AZ. C dimension is 112 mm.	

\*: Intermediate stroke (in 1 mm increments) based on an exclusive body will be available upon request for special.

## Theoretical Output

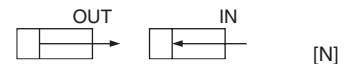

Bore size [mm]	Rod size [mm]	Operating direction	Piston area [mm <sup>2</sup> ]	Operating pressure [MPa]								
				0.2	0.3	0.4	0.5	0.6	0.7	0.8	0.9	1.0
16	8	OUT	201	40	60	80	101	121	141	161	181	201
		IN	151	30	45	60	75	90	106	121	136	151
20	10	OUT	314	63	94	126	157	188	220	251	283	314
		IN	236	47	71	94	118	141	165	188	212	236
25	10	OUT	491	98	147	196	245	295	344	393	442	491
		IN	412	82	124	165	206	247	289	330	371	412
32	14	OUT	804	161	241	322	402	483	563	643	724	804
		IN	650	130	195	260	325	390	455	520	585	650
40	14	OUT	1257	251	377	503	628	754	880	1005	1131	1257
		IN	1103	221	331	441	551	662	772	882	992	1103
50	20	OUT	1963	393	589	785	982	1178	1374	1571	1767	1963
		IN	1649	330	495	660	825	990	1154	1319	1484	1649
63	20	OUT	3117	623	935	1247	1559	1870	2182	2494	2806	3117
		IN	2803	561	841	1121	1402	1682	1962	2242	2523	2803
80	25	OUT	5027	1005	1508	2011	2513	3016	3519	4021	4524	5027
		IN	4536	907	1361	1814	2268	2722	3175	3629	4082	4536
100	30	OUT	7854	1571	2356	3142	3927	4712	5498	6283	7069	7854
		IN	7147	1429	2144	2859	3574	4288	5003	5718	6432	7147

\*: Theoretical output [N] = Pressure [MPa] x Piston area [mm<sup>2</sup>]

# Series MGP

## Weights

### Slide Bearing: MGPM16 to 100 [kg]

Bore size [mm]	Standard stroke [mm]											
	25	50	75	100	125	150	175	200	250	300	350	400
16	0.46	0.62	0.74	0.83	1.02	1.10	1.19	1.28	1.46	—	—	—
20	0.77	1.02	1.21	1.35	1.49	1.63	1.77	1.91	2.55	2.83	3.11	3.39
25	1.06	1.43	1.68	1.84	2.01	2.18	2.35	2.52	3.50	3.84	4.18	4.51
32	1.66	2.06	2.42	2.65	2.88	3.11	3.34	3.57	5.07	5.53	5.99	6.46
40	1.95	2.40	2.79	3.06	3.33	3.59	3.86	4.13	5.71	6.25	6.78	7.32
50	3.26	3.96	4.55	4.96	5.36	5.76	6.16	6.56	9.03	9.83	10.63	11.43
63	4.11	4.90	5.58	6.07	6.56	7.05	7.54	8.04	10.68	11.66	12.64	13.63
80	—	7.47	8.35	8.95	9.55	10.15	10.75	11.35	15.04	16.24	17.44	18.65
100	—	12.10	13.37	14.24	15.11	15.98	16.85	17.72	22.88	24.62	26.36	28.10

### Ball Bushing: MGPL16 to 100, High Precision Ball Bushing: MGPA16 to 100 [kg]

Bore size [mm]	Standard stroke [mm]											
	25	50	75	100	125	150	175	200	250	300	350	400
16	0.48	0.58	0.66	0.83	0.94	1.02	1.11	1.19	1.36	—	—	—
20	0.82	0.97	1.10	1.35	1.50	1.63	1.76	1.89	2.33	2.59	2.84	3.10
25	1.16	1.34	1.49	1.83	2.03	2.18	2.34	2.49	3.11	3.41	3.72	4.02
32	1.58	2.00	2.29	2.67	2.95	3.15	3.36	3.57	4.47	4.88	5.29	5.70
40	1.87	2.33	2.65	3.06	3.38	3.63	3.87	4.11	5.09	5.57	6.06	6.54
50	3.10	3.81	4.30	4.92	5.42	5.79	6.17	6.55	8.08	8.83	9.58	10.33
63	3.94	4.74	5.34	6.05	6.64	7.11	7.58	8.05	9.77	10.71	11.65	12.59
80	—	7.61	8.35	8.91	9.46	10.02	10.57	11.13	13.99	15.10	16.21	17.32
100	—	12.04	13.14	13.97	14.79	15.62	16.44	17.27	21.14	22.80	24.45	26.10

## Allowable Rotational Torque of Plate

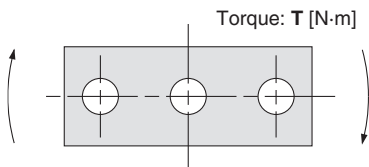

Bore size [mm]	Bearing type	Stroke											
		25	50	75	100	125	150	175	200	250	300	350	400
16	MGPM	0.53	0.84	0.69	0.58	0.50	0.44	0.40	0.36	0.30	—	—	—
	MGPL/A	1.27	0.86	0.65	0.52	0.43	0.37	0.32	0.28	0.23	—	—	—
20	MGPM	0.99	2.23	1.88	1.63	1.44	1.28	1.16	1.06	0.90	0.78	0.69	0.62
	MGPL/A	2.66	1.94	1.52	1.57	1.34	1.17	1.03	0.93	0.76	0.65	0.56	0.49
25	MGPM	1.64	3.51	2.96	2.57	2.26	2.02	1.83	1.67	1.42	1.24	1.09	0.98
	MGPL/A	4.08	3.02	2.38	2.41	2.05	1.78	1.58	1.41	1.16	0.98	0.85	0.74
32	MGPM	6.35	6.64	5.69	4.97	4.42	3.98	3.61	3.31	2.84	2.48	2.20	1.98
	MGPL/A	5.95	5.89	5.11	6.99	6.34	5.79	5.33	4.93	4.29	3.78	3.38	3.04
40	MGPM	7.00	7.32	6.27	5.48	4.87	4.38	3.98	3.65	3.13	2.74	2.43	2.19
	MGPL/A	6.55	6.49	5.62	7.70	6.98	6.38	5.87	5.43	4.72	4.16	3.71	3.35
50	MGPM	13.0	13.8	12.0	10.6	9.50	8.60	7.86	7.24	6.24	5.49	4.90	4.43
	MGPL/A	9.17	11.2	9.80	12.8	11.6	10.7	9.80	9.10	7.95	7.02	6.26	5.63
63	MGPM	14.7	15.6	13.5	11.9	10.7	9.69	8.86	8.16	7.04	6.19	5.52	4.99
	MGPL/A	10.2	12.5	11.0	14.3	13.0	11.9	11.0	10.2	8.84	7.80	6.64	6.24
80	MGPM	—	26.0	22.9	20.5	18.6	17.0	15.6	14.5	12.6	11.2	10.0	9.11
	MGPL/A	—	25.2	22.7	20.6	18.9	17.3	16.0	14.8	12.9	11.3	10.0	8.94
100	MGPM	—	41.9	37.5	33.8	30.9	28.4	26.2	24.4	21.4	19.1	17.2	15.7
	MGPL/A	—	41.7	37.9	34.6	31.8	29.3	27.2	25.3	22.1	19.5	17.3	15.5

## High Precision Ball Bushing/MGPA

### ⚠ Caution

#### Positioning accuracy for pin hole on the plate

Dispersion of dimensions when machining each component will be accumulated in the plate pin hole positioning accuracy when mounting this cylinder. Values below are referred as a guide.

[Side mounting]

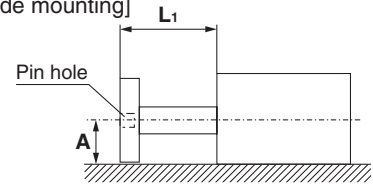

$$A = \text{[Catalogue dimension]} \pm (0.1 + L_1 \times 0.0008) \text{ [mm]}^{*1}$$

\*1: To be 0.15 for  $\varnothing 80$ ,  $\varnothing 100$

\*: Displacement by load and self-weight deflection by plate and guide are not included.

[Bottom mounting]

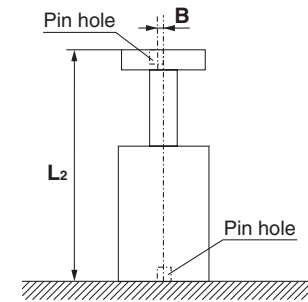

$$B = \pm (0.045 + L_2 \times 0.0016) \text{ [mm]}$$

## Non-rotating Accuracy of Plate

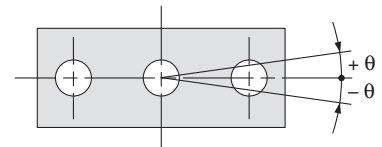

Non-rotating accuracy  $\theta$  when retracted and when no load is applied should be not more than the values shown in the table.

Bore size [mm]	Non-rotating accuracy $\theta$		
	MGPM	MGPL	MGPA
16	$\pm 0.07^\circ$	$\pm 0.05^\circ$	$\pm 0.01^\circ$
20	$\pm 0.06^\circ$	$\pm 0.04^\circ$	
25	$\pm 0.05^\circ$	$\pm 0.03^\circ$	
32	$\pm 0.05^\circ$	$\pm 0.03^\circ$	
40	$\pm 0.04^\circ$	$\pm 0.03^\circ$	
50	$\pm 0.04^\circ$	$\pm 0.03^\circ$	
63	$\pm 0.03^\circ$	$\pm 0.03^\circ$	
80	$\pm 0.03^\circ$	$\pm 0.03^\circ$	
100	$\pm 0.03^\circ$	$\pm 0.03^\circ$	



**High Precision Ball Bushing/MGPA Plate Displacement Amount (Reference Values)**

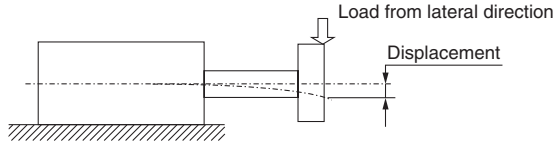

**MGPA16**

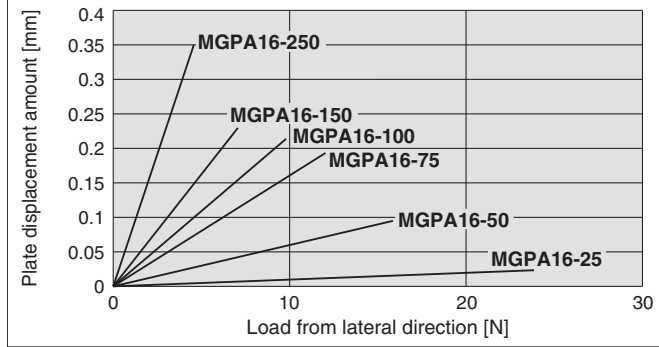

**MGPA50, 63**

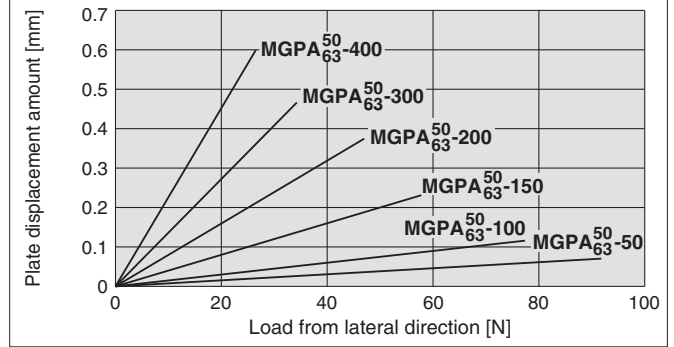

**MGPA20**

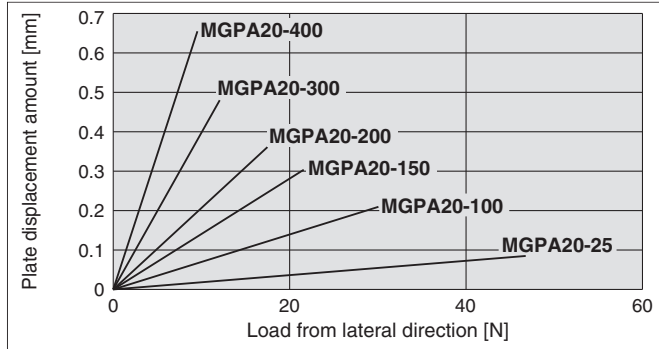

**MGPA80**

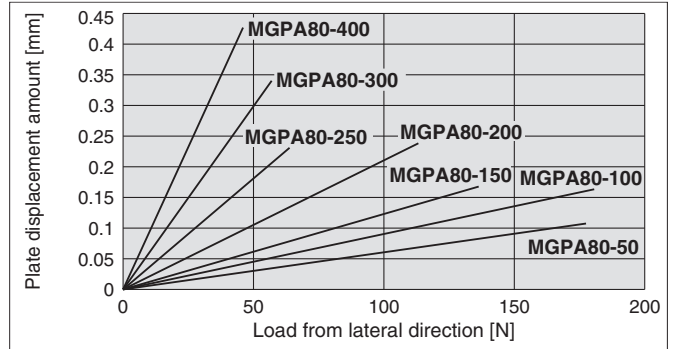

**MGPA25**

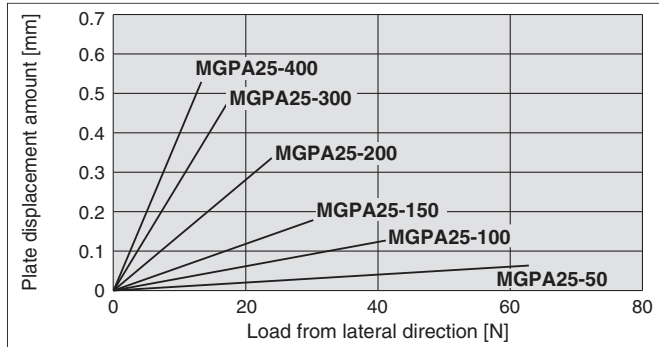

**MGPA100**

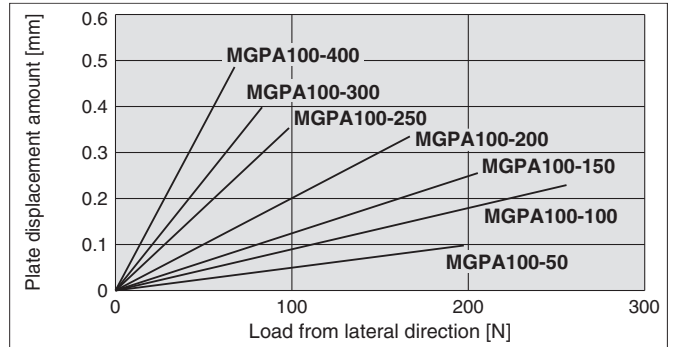

**MGPA32, 40**

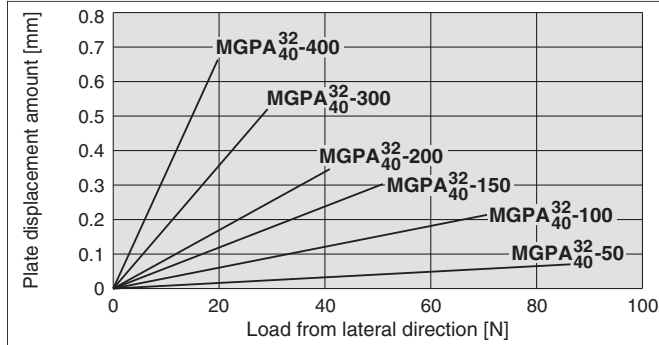

\*: The guide rod and self-weight for the plate are not included in the above displacement values.  
\*: Allowable rotating torque, and operating range when used as a lifter, are the same as those of the MGPL series.

Basic Type  
**MGP-Z**

With Air Cushion  
**MGP-AZ**

With End Lock  
**MGP**

Heavy Duty Guide Rod Type  
**MGPS**

**Auto Switch**

**Made to Order**

# With Air Cushion Series MGP Model Selection

## Selection Conditions

Mounting orientation	Vertical		Horizontal	
Maximum speed [mm/s]	200 or less	400	200 or less	400
Graph (Slide bearing)	(1), (2)	(3), (4)	(15), (16)	(17), (18)
Graph (Ball bushing)	(5) to (9)	(10) to (14)	(19), (20)	(21), (22)

### Selection Example 1 (Vertical Mounting)

#### Selection conditions

Mounting: Vertical  
Bearing type: Ball bushing  
Stroke: 75 stroke  
Maximum speed: 200 mm/s  
Work load: 7 kg  
Eccentric distance: 70 mm

Find the point of intersection for the work load of 7 kg and the eccentric distance of 70 mm on graph (5), based on vertical mounting, ball bushing, 75 mm stroke, and the speed of 200 mm/s.

→ **MGPL25-75AZ** is selected.

(5) 75 stroke or less,  $V = 200$  mm/s or less

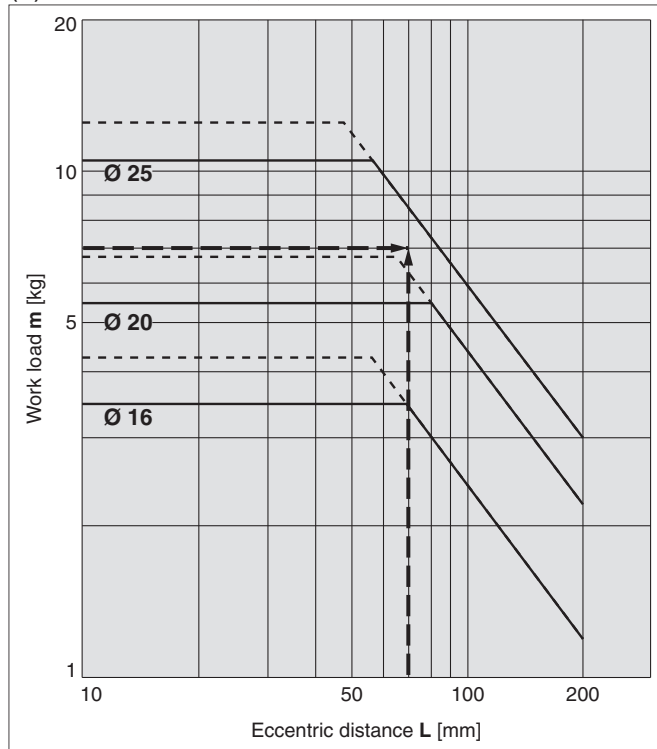

### Selection Example 2 (Horizontal Mounting)

#### Selection conditions

Mounting: Horizontal  
Bearing type: Slide bearing  
Distance between plate and load centre of gravity: 40 mm  
Maximum speed: 400 mm/s  
Work load: 8 kg  
Stroke: 100 stroke

Find the point of intersection for the work load of 8 kg and 100 stroke on graph (17), based on horizontal mounting, slide bearing, the distance of 40 mm between the plate and load centre of gravity, and the speed of 400 mm/s.

→ **MGPM32-100AZ** is selected.

(17)  $L = 50$  mm,  $V = 400$  mm/s

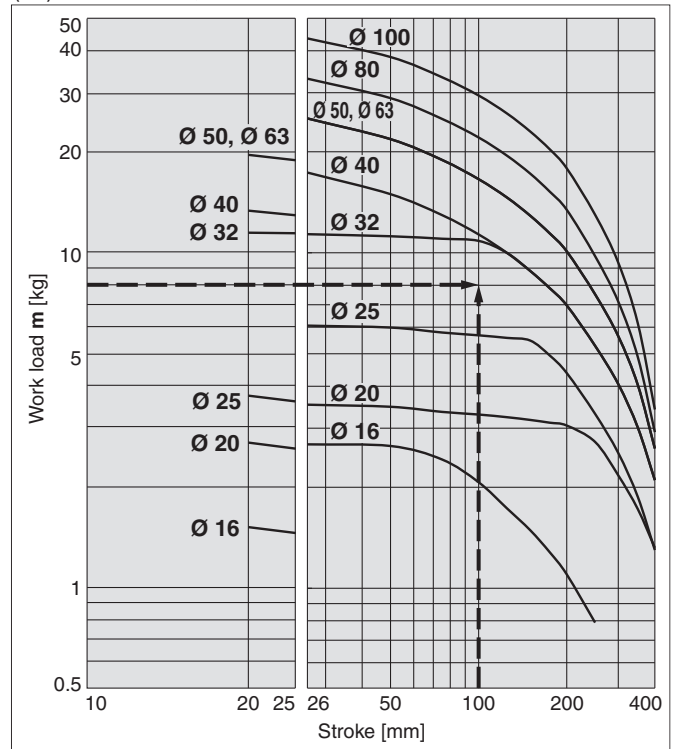

· When the maximum speed exceeds 200 mm/s, the allowable work load is determined by multiplying the value shown in the graph at 400 mm/s by the coefficient listed in the table below.

Maximum	Up to 300 mm/s	Up to 400 mm/s	Up to 500 mm/s
Coefficient	1.7	1	0.6

· Use the Guide Cylinder Selection Software, when the eccentric distance is 200 mm or more.

**Vertical Mounting** Slide Bearing

— Operating pressure 0.4 MPa  
 - - - - - Operating pressure 0.5 MPa or more

**MGPM16 to 100**

(1) 25 stroke, V = 200 mm/s or less

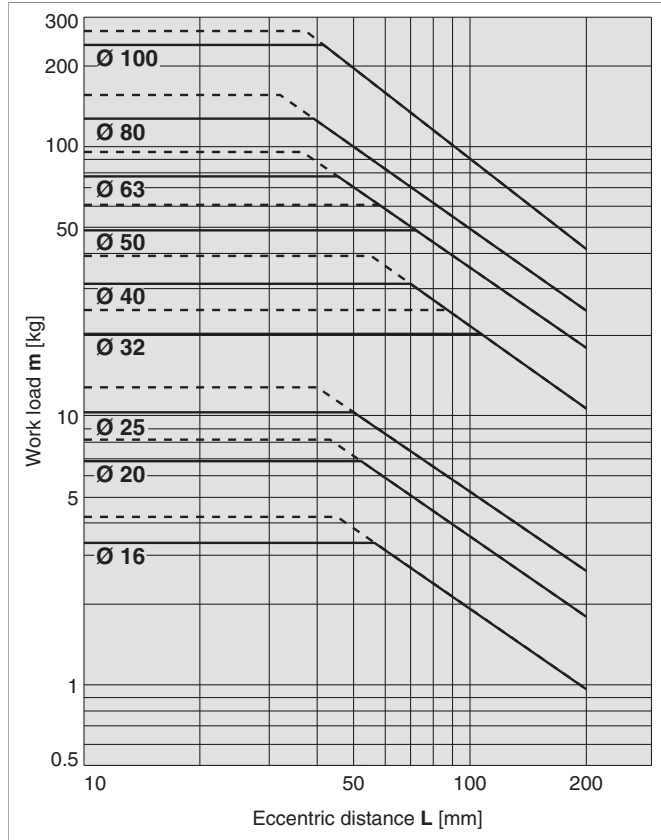

(2) Over 25 stroke, V = 200 mm/s or less

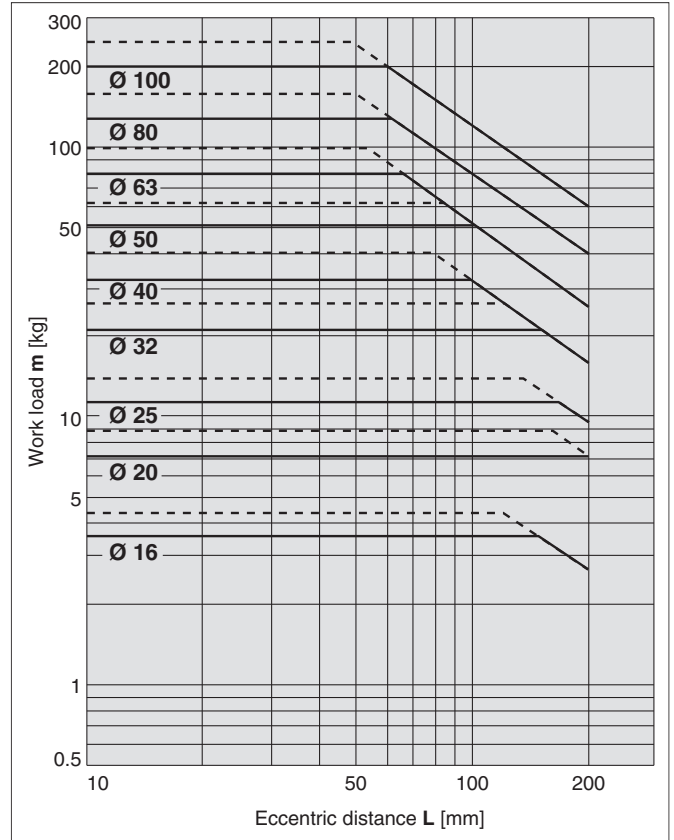

(3) 25 stroke, V = 400 mm/s

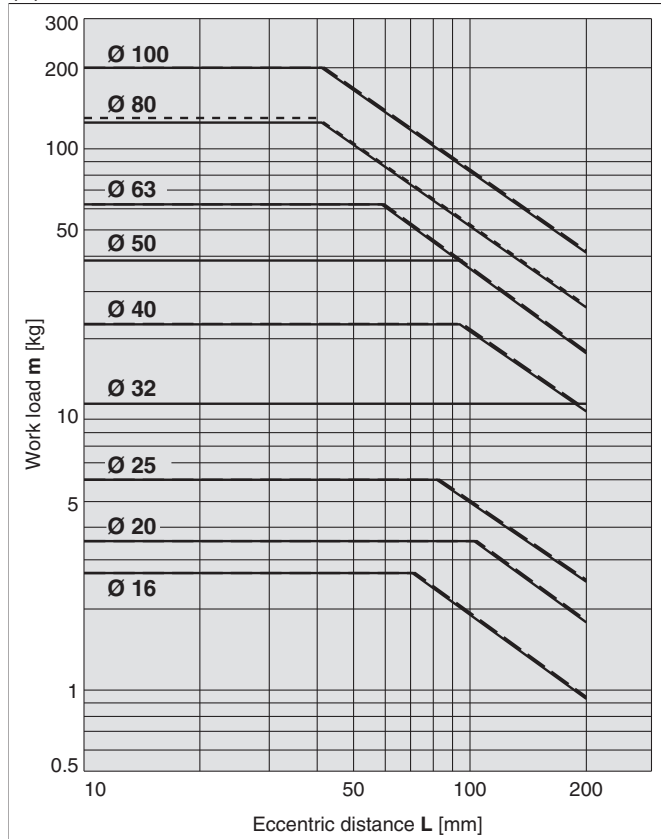

(4) Over 25 stroke, V = 400 mm/s

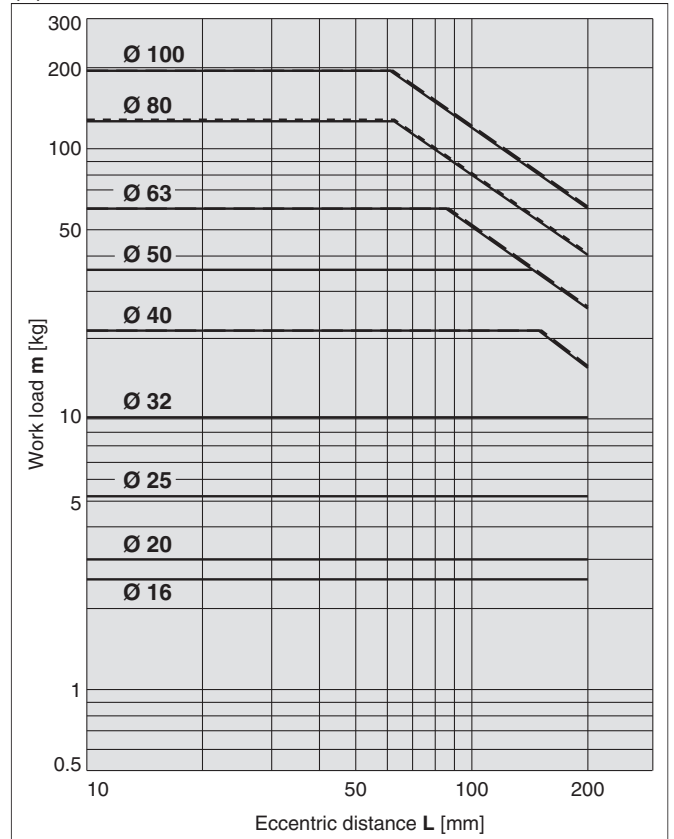

· Use the Guide Cylinder Selection Software, when the eccentric distance is 200 mm or more.

Basic Type  
**MGP-Z**

With Air Cushion  
**MGP-AZ**

With End Lock  
**MGP**

Heavy Duty Guide Rod Type  
**MGPS**

**Auto Switch**

**Made to Order**

# Series MGP

## Vertical Mounting **Ball Bushing**

— Operating pressure 0.4 MPa  
 - - - - Operating pressure 0.5 MPa or more

### MGPL16 to 25

(5) 75 stroke or less, V = 200 mm/s or less

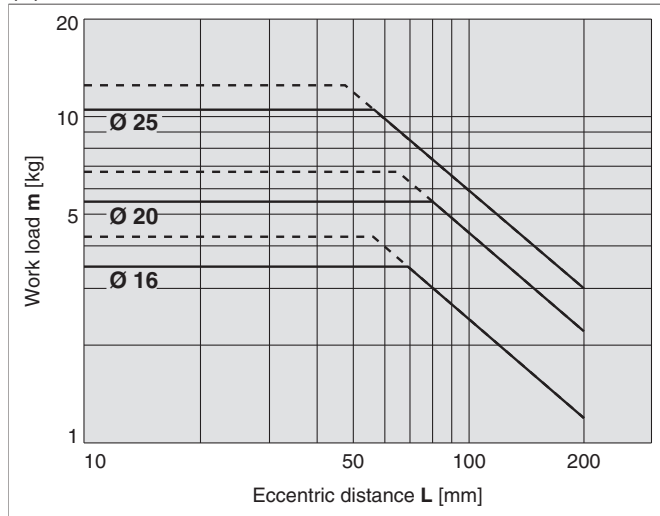

(6) Over 75 stroke, V = 200 mm/s or less

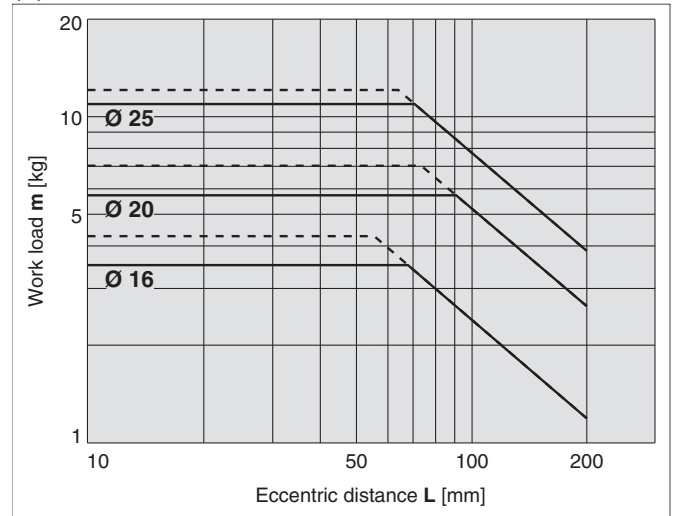

### MGPL32 to 63

(7) 25 stroke, V = 200 mm/s or less

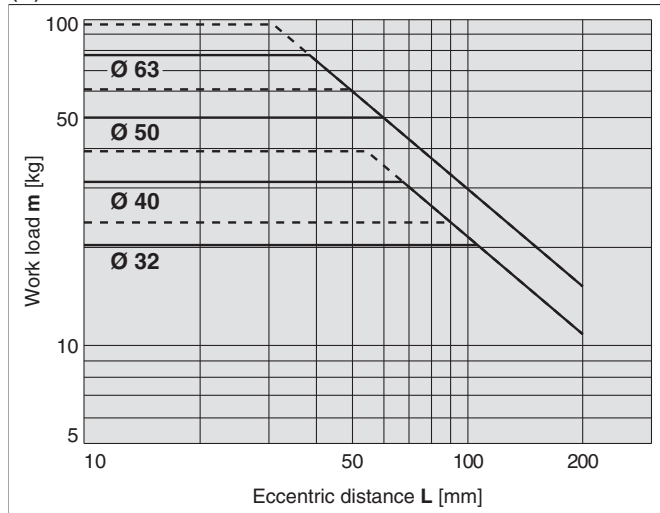

(8) Over 25 stroke, V = 200 mm/s or less

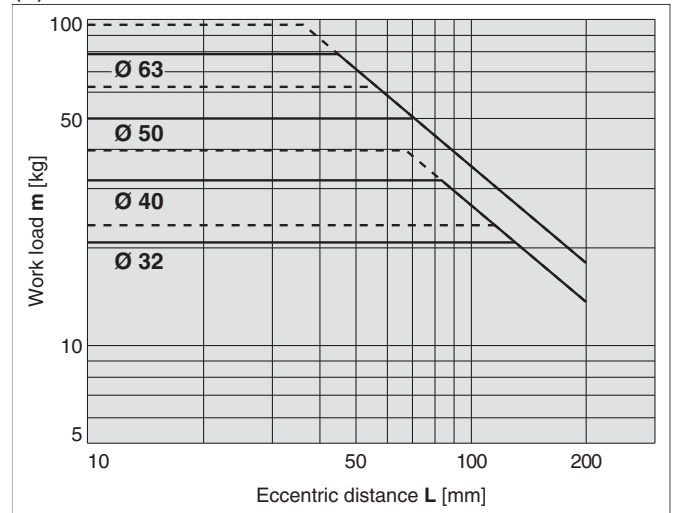

### MGPL80/100

(9) V = 200 mm/s or less

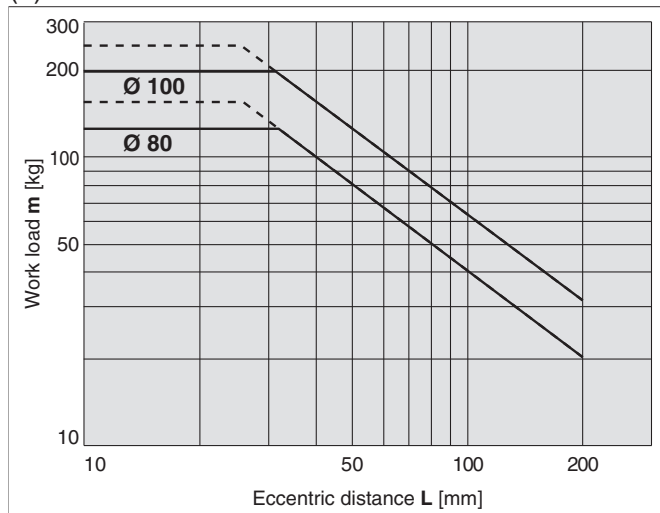

· Use the Guide Cylinder Selection Software, when the eccentric distance is 200 mm or more.

**Vertical Mounting** **Ball Bushing**

— Operating pressure 0.4 MPa

**MGPL16 to 25**

(10) 75 stroke or less, V = 400 mm/s

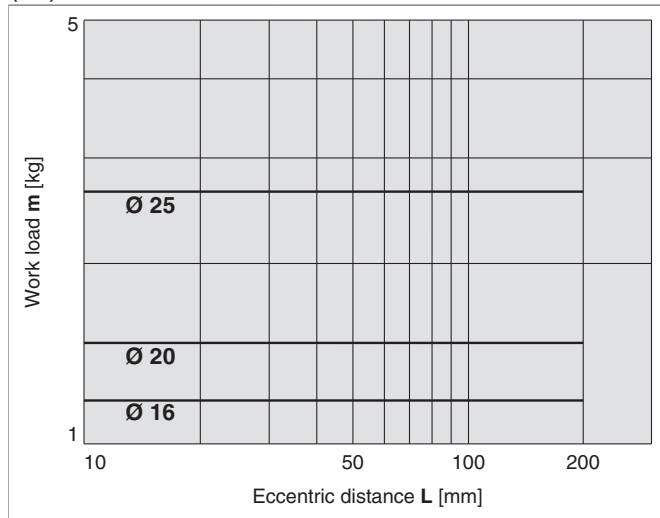

(11) Over 75 stroke, V = 400 mm/s

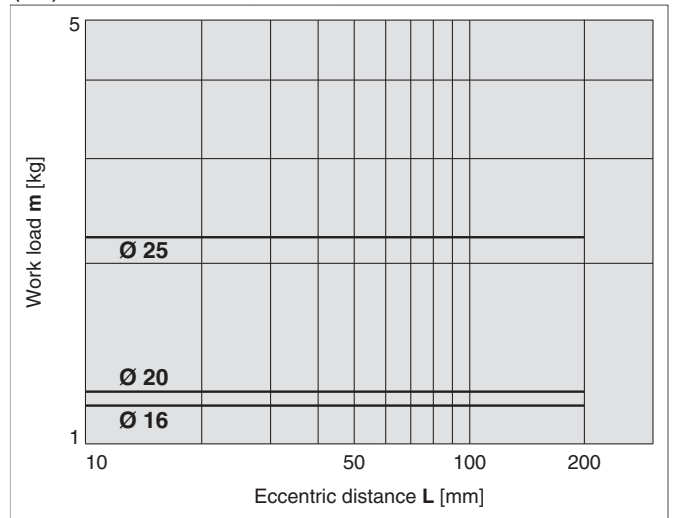

**MGPL32 to 63**

(12) 25 stroke, V = 400 mm/s

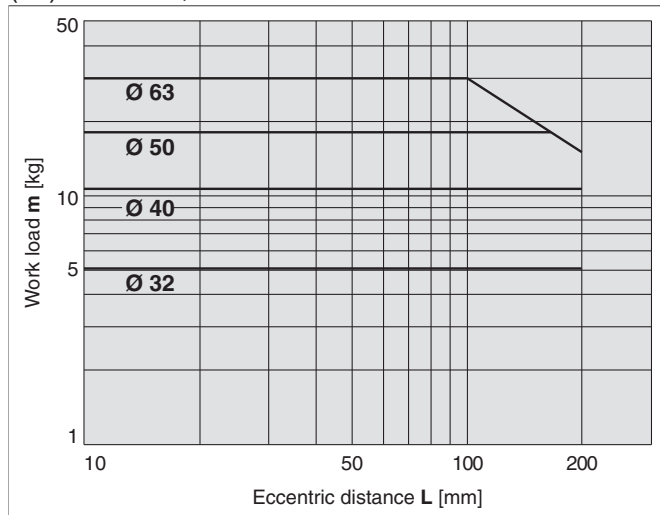

(13) Over 25 stroke, V = 400 mm/s

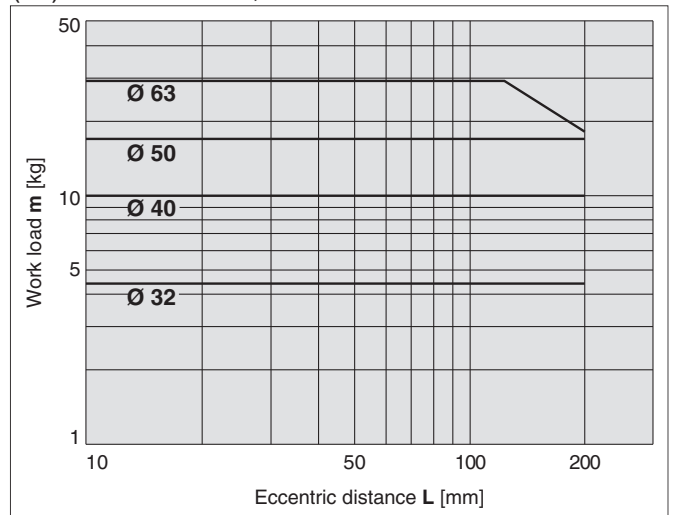

**MGPL80/100**

(14) V = 400 mm/s

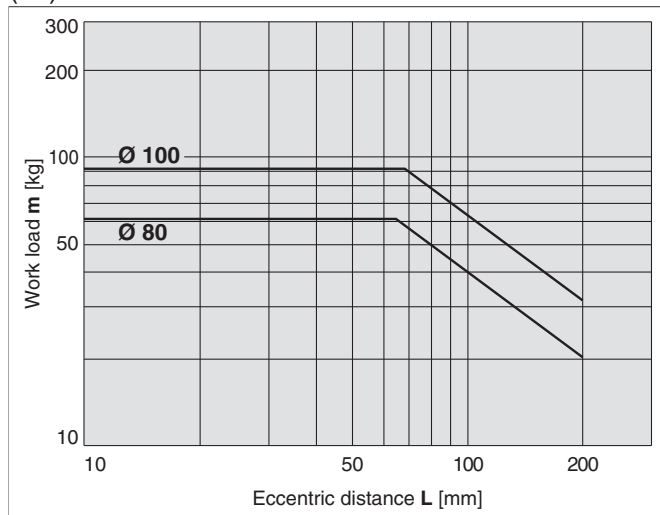

· Use the Guide Cylinder Selection Software, when the eccentric distance is 200 mm or more.

Basic Type  
**MGP-Z**

With Air Cushion  
**MGP-AZ**

With End Lock  
**MGP**

Heavy Duty Guide Rod Type  
**MGPS**

**Auto Switch**

**Made to Order**

# Series MGP

## Horizontal Mounting Slide Bearing

### MGPM16 to 100

(15) L = 50 mm, V = 200 mm/s or less

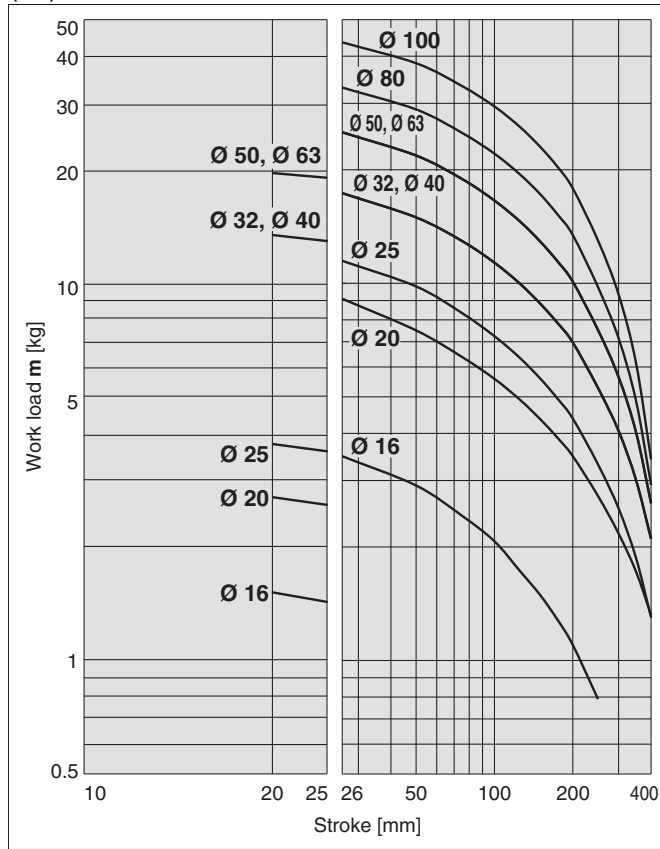

(16) L = 100 mm, V = 200 mm/s or less

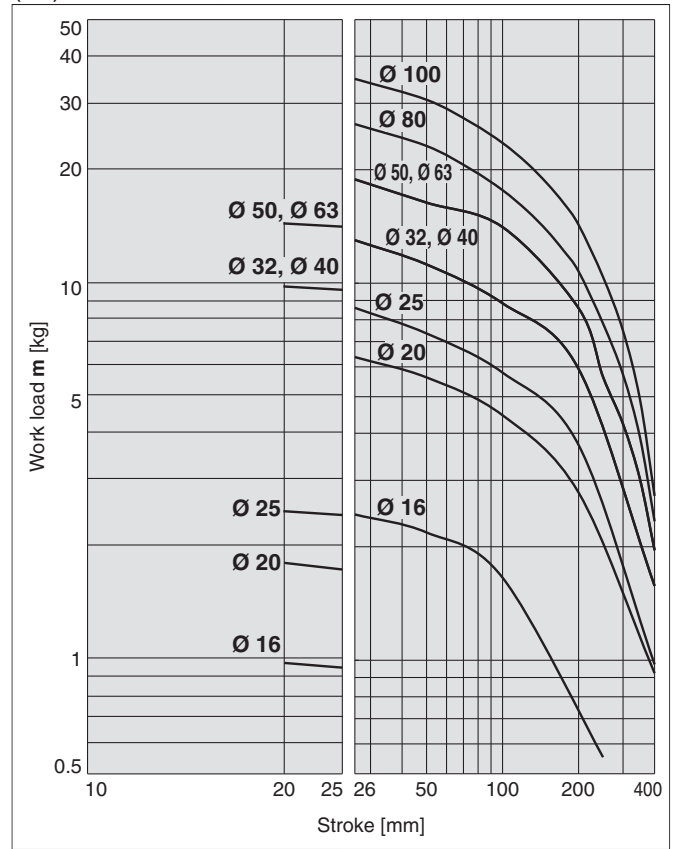

(17) L = 50 mm, V = 400 mm/s

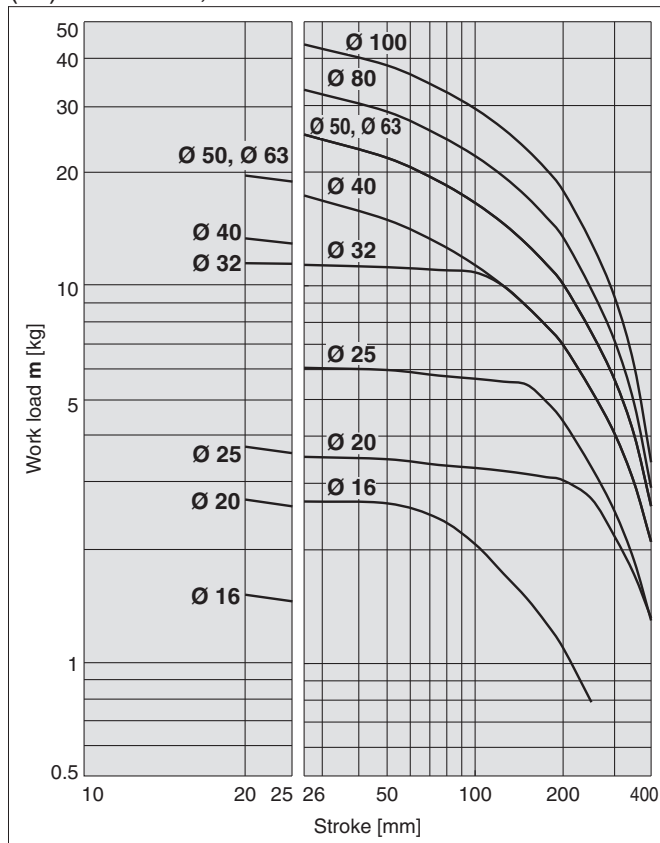

(18) L = 100 mm, V = 400 mm/s

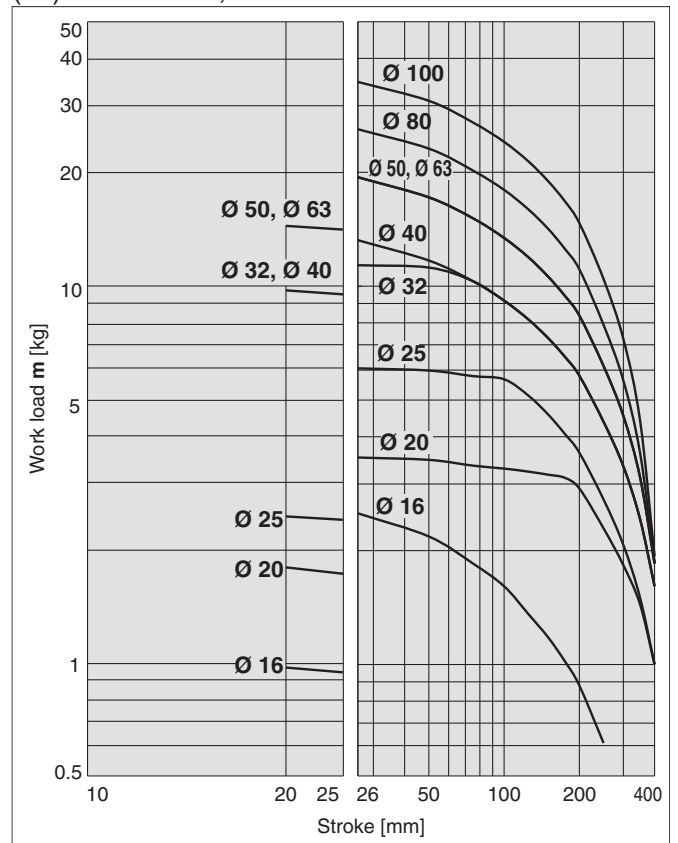

**Horizontal Mounting** **Ball Bushing**

(19) L = 50 mm, V = 200 mm/s or less

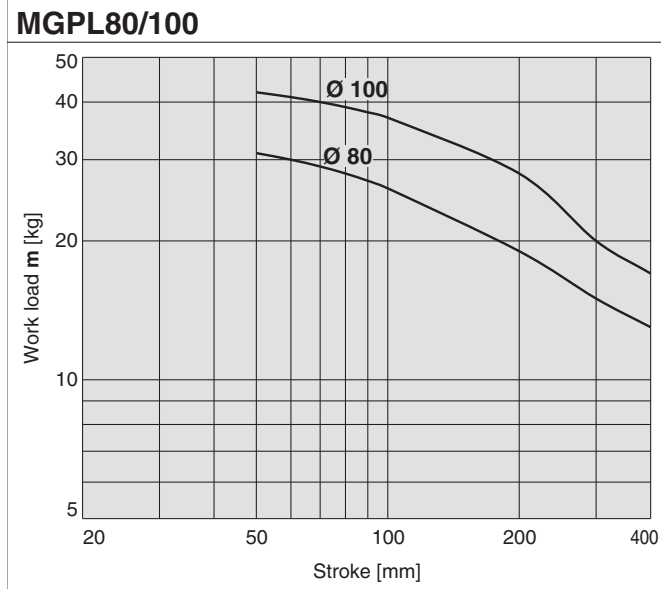
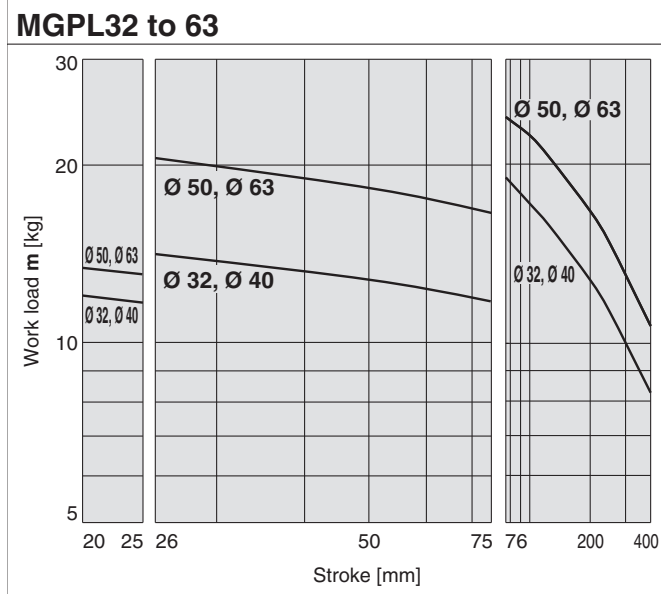
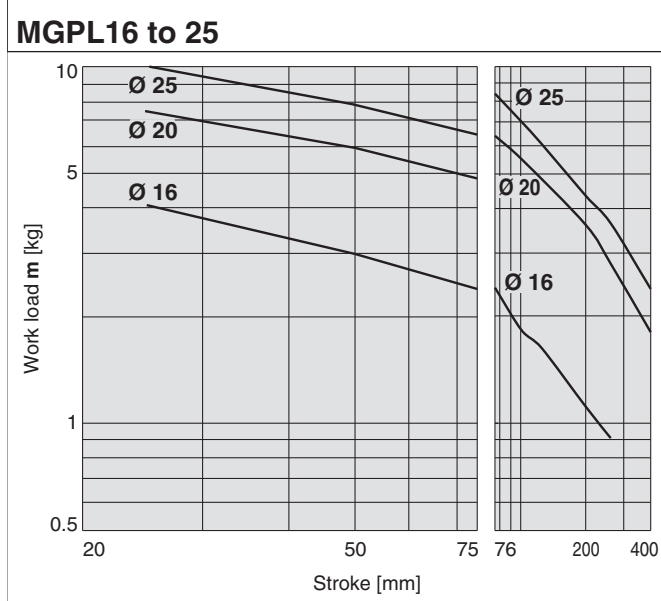

(20) L = 100 mm, V = 200 mm/s or less

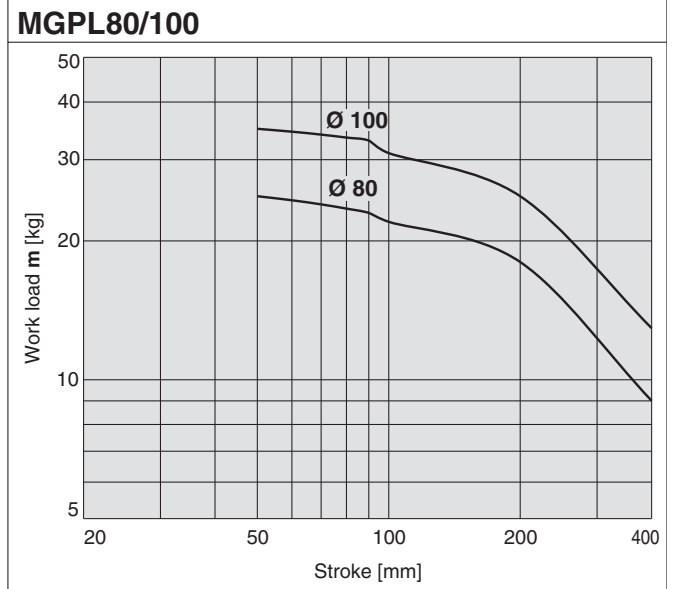
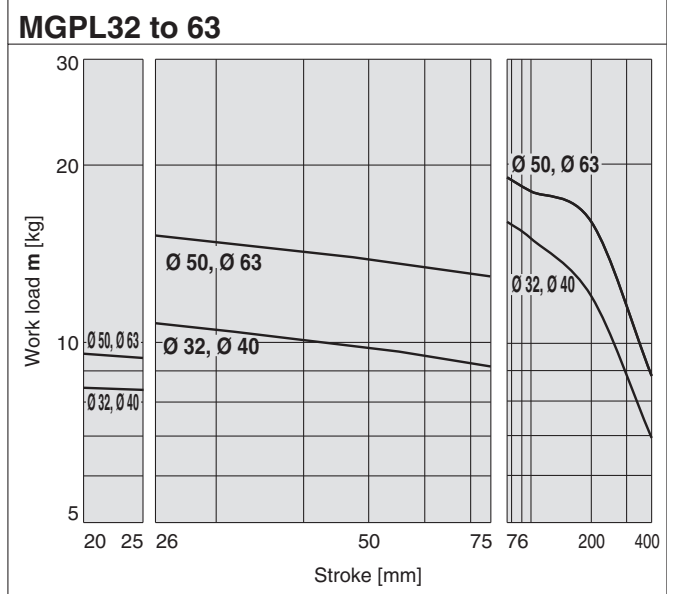
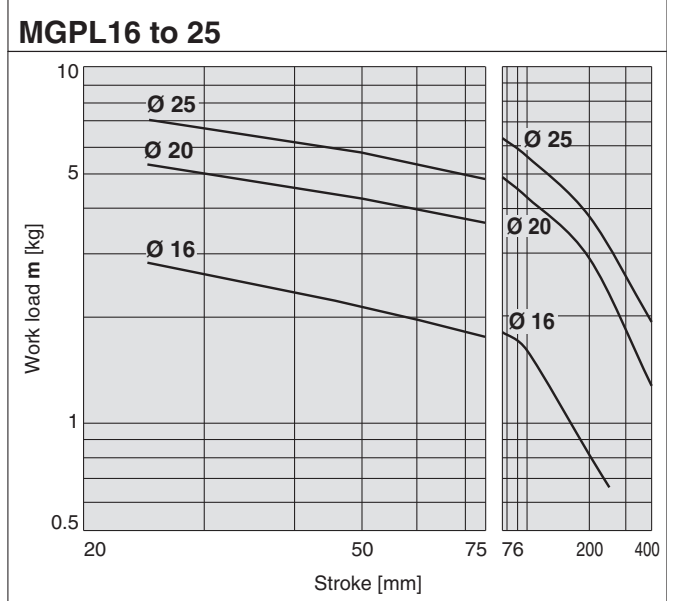

Basic Type **MGP-Z**

With Air Cushion **MGP-AZ**

With End Lock **MGP**

Heavy Duty Guide Rod Type **MGPS**

Auto Switch

Made to Order

# Series MGP

## Horizontal Mounting **Ball Bushing**

(21) L = 50 mm, V = 400 mm/s

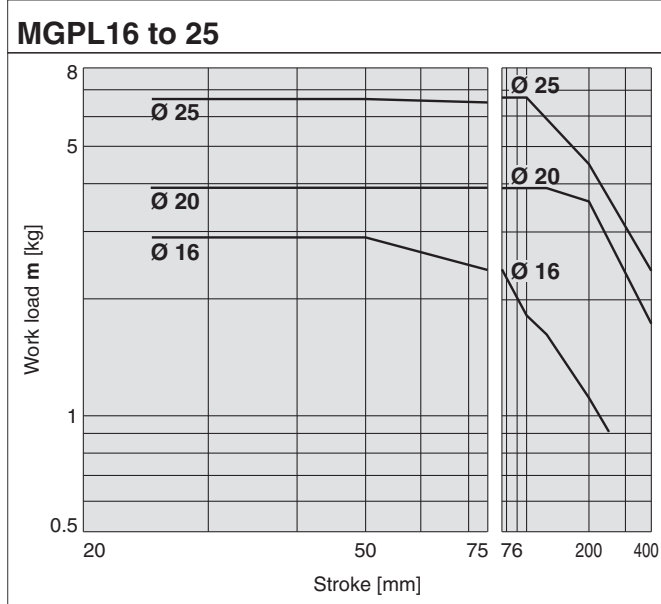

(22) L = 100 mm, V = 400 mm/s

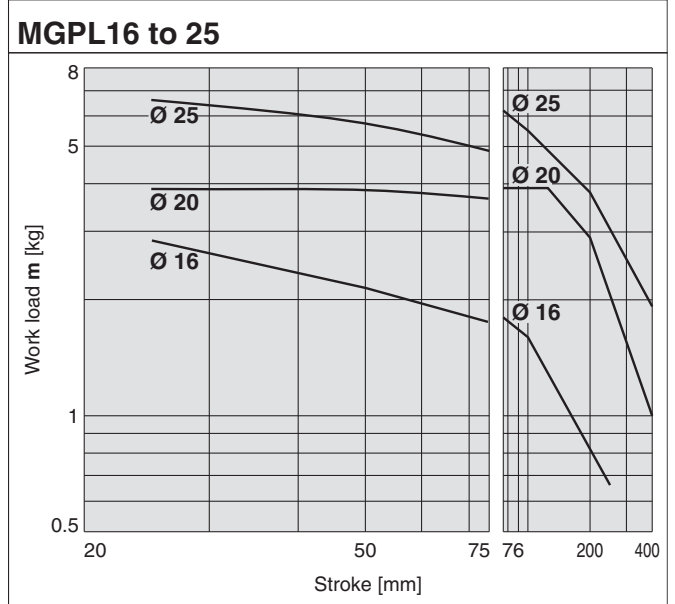

### MGPL32 to 63

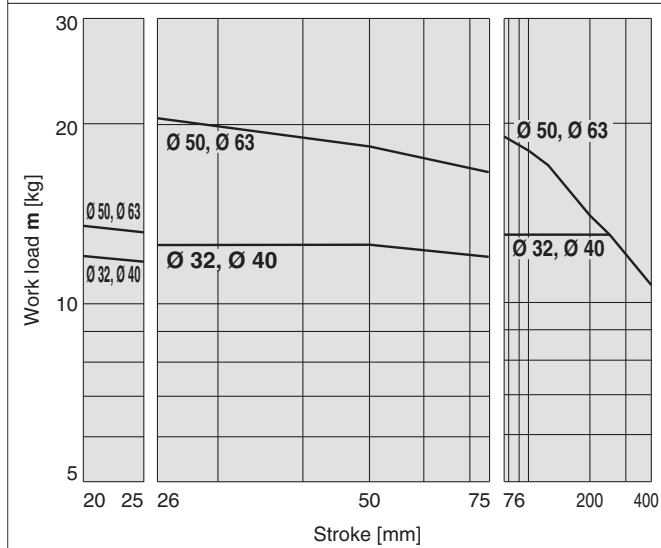

### MGPL32 to 63

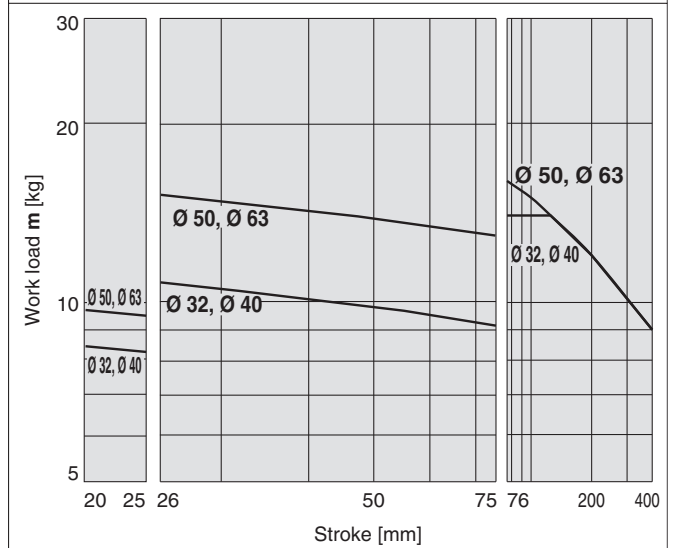

### MGPL80/100

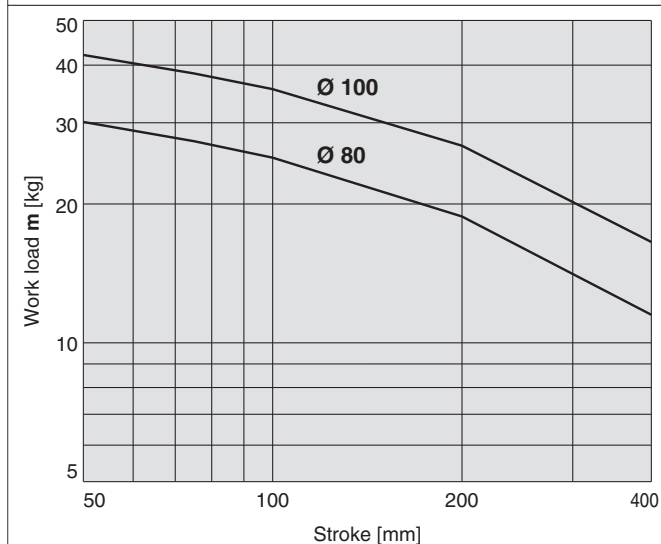

### MGPL80/100

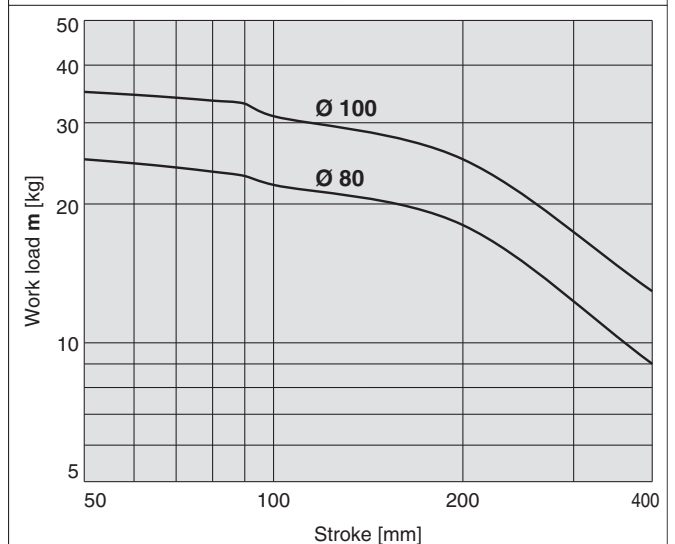



**Operating Range when Used as Stopper**

**Bore Size  $\varnothing$  16 to  $\varnothing$  25/MGPM16 to 25 (Slide Bearing)**

**MGPM16 to 25 (Slide Bearing)**

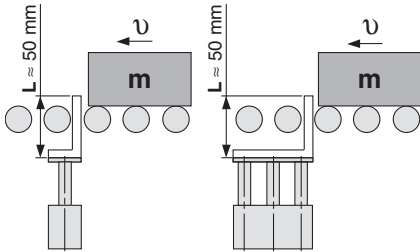

\*: When selecting a model with a longer **L** dimension, be sure to choose a bore size which is sufficiently large.

**⚠ Caution**

**Caution on handling**

1. When using as a stopper, select a model with 25 stroke or less.
2. The MGPL (Ball bushing) and the MGPA (High precision ball bushing) cannot be used as a stopper.

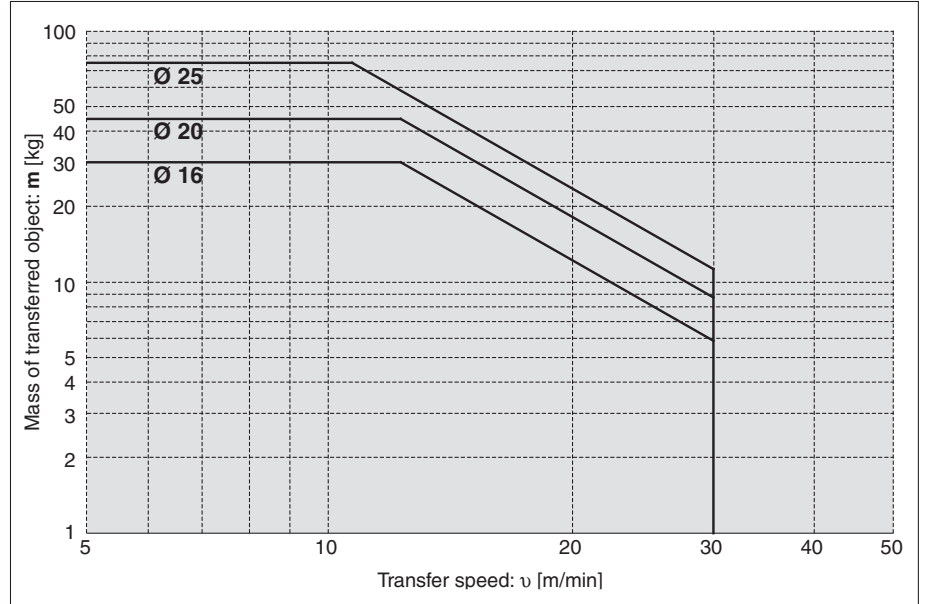

**Bore Size  $\varnothing$  32 to  $\varnothing$  100/MGPM32 to 100 (Slide Bearing)**

**MGPM32 to 100 (Slide Bearing)**

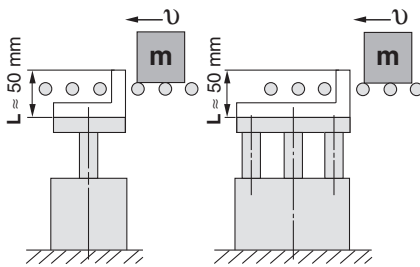

\*: When selecting a model with a longer **L** dimension, be sure to choose a bore size which is sufficiently large.

**⚠ Caution**

**Caution on handling**

1. When using as a stopper, select a model with 50 stroke or less.
2. The MGPL (Ball bushing) and the MGPA (High precision ball bushing) cannot be used as a stopper.

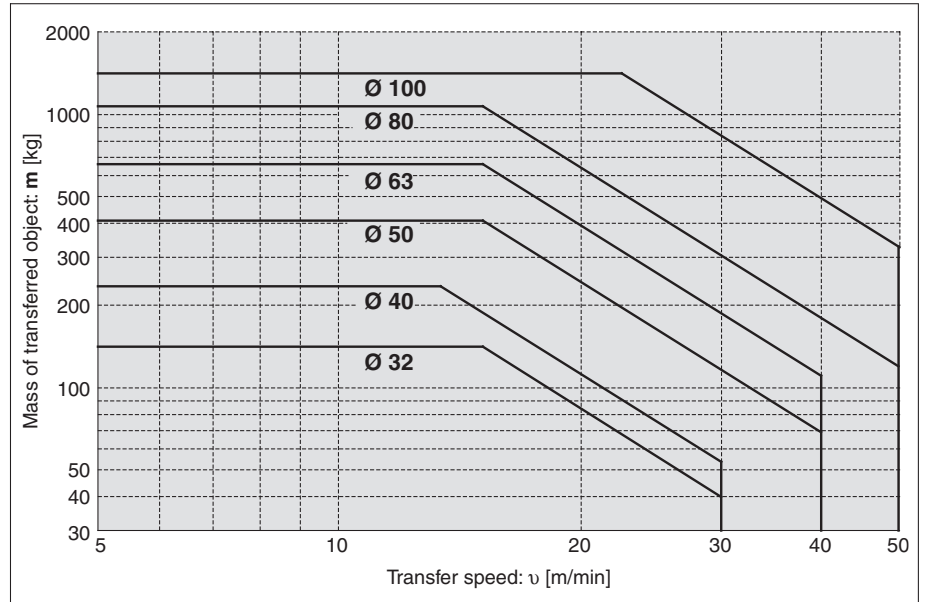

\*: Refer to graphs (15) and (17) if line pressure is applied by a roller conveyor after the workpiece is stopped.

Basic Type  
**MGP-Z**

With Air Cushion  
**MGP-AZ**

With End Lock  
**MGP**

Heavy Duty Guide Rod Type  
**MGPS**

**Auto Switch**

**Made to Order**

# Series MGP

## Construction (With Air Cushion)/Series MGPM

### MGPM

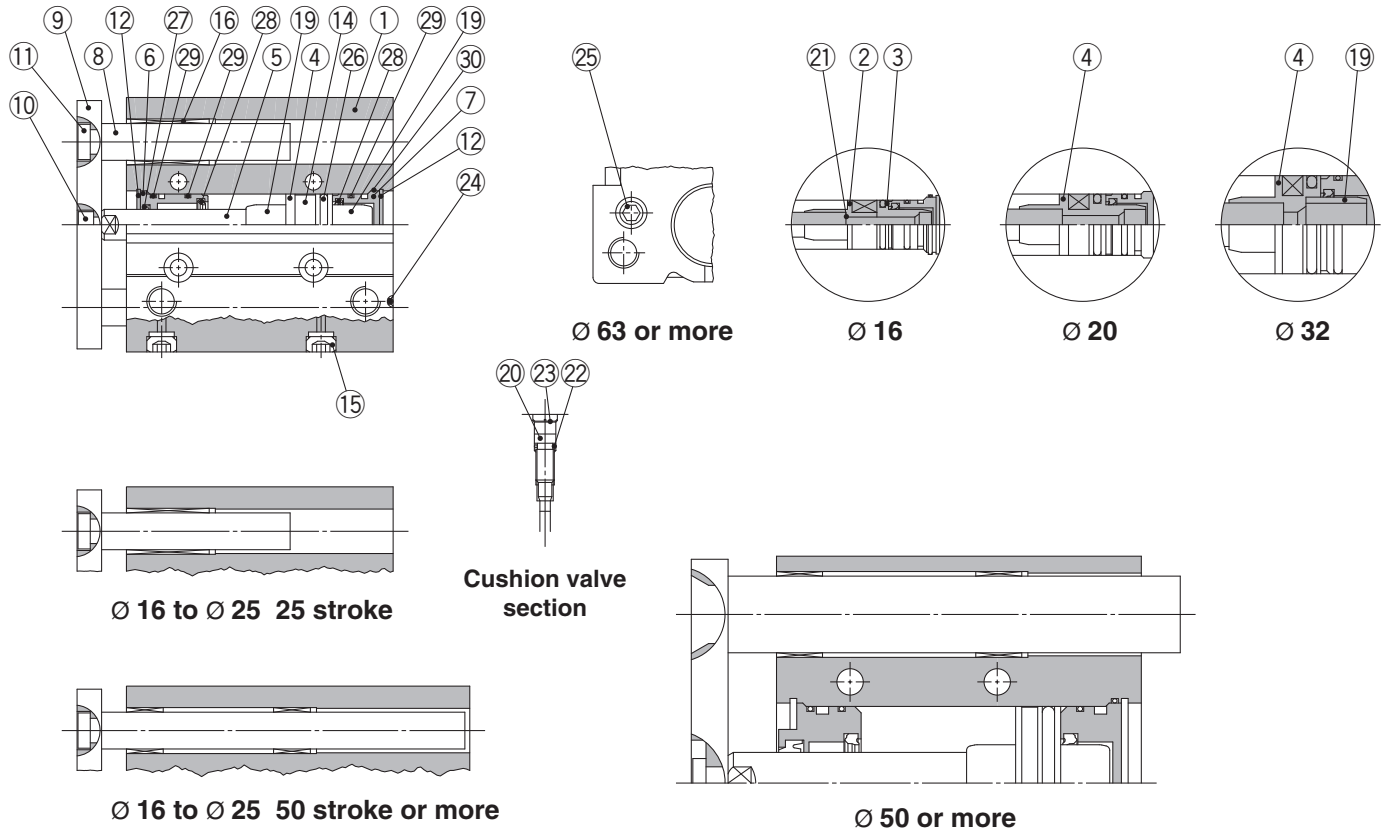

### Component Parts

No.	Description	Material	Note
1	Body	Aluminium alloy	Hard anodised
2	Piston A	Aluminium alloy	Ø 16
3	Piston B	Aluminium alloy	Ø 16
4	Piston	Aluminium alloy	Ø 20 to Ø 100
5	Piston rod	Stainless steel	Ø 16 to Ø 25
		Carbon steel	Ø 32 to Ø 100   Hard chrome plating
6	Collar	Aluminium alloy	Chromated
7	Head cover	Aluminium alloy	Chromated
8	Guide rod	Carbon steel	Hard chrome plating
9	Plate	Carbon steel	Nickel plating
10	Plate mounting bolt	Carbon steel	Nickel plating
11	Guide bolt	Carbon steel	Nickel plating
12	Retaining ring	Carbon tool steel	Phosphate coated
13	Retaining ring	Carbon tool steel	Phosphate coated
14	Magnet	—	
15	Plug Hexagon socket head plug	Carbon steel	Ø 16
			Ø 20 to Ø 100
16	Slide bearing	Bearing alloy	
17	Ball bushing	—	
18	Spacer	Aluminium alloy	
19	Cushion ring	Aluminium alloy	Ø 25 to Ø 100
			Ø 16 to Ø 32
			Ø 50 to Ø 100
20	Cushion valve	—	Electroless nickel plating
			Chromated
	Cushion needle	—	Ø 40 only   Electroless nickel plating

\*: A felt is not installed on the slide bearing.

### Component Parts

No.	Description	Material	Note
21	Gasket	NBR	Ø 16
22	Gasket	NBR	
23	Retaining ring	Carbon tool steel	Ø 50, Ø 63   Phosphate coated
24	Steel ball	Carbon steel	Ø 16 to Ø 50
25	Plug	Carbon steel	Ø 63 to Ø 100   Nickel plating
26*	Piston seal	NBR	
27*	Rod seal	NBR	
28*	Cushion seal	Urethane	
29*	Gasket A	NBR	
30*	Gasket B	NBR	

### Replacement Parts/Seal Kit

Bore size [mm]	Kit no.	Contents	Bore size [mm]	Kit no.	Contents
16	MGP16-AZ-PS	Set of nos. above 26, 27, 28, 29, 30	50	MGP50-AZ-PS	Set of nos. above 26, 27, 28, 29, 30
20	MGP20-AZ-PS		63	MGP63-AZ-PS	
25	MGP25-AZ-PS		80	MGP80-AZ-PS	
32	MGP32-AZ-PS		100	MGP100-AZ-PS	
40	MGP40-AZ-PS				

\*: Seal kit includes 26 to 30. Order the seal kit, based on each bore size.

\*: Since the seal kit does not include a grease pack, order it separately.

Grease pack part no.: GR-S-010 (10 g)

**Construction (With Air Cushion)/Series MGPL**

**MGPL**

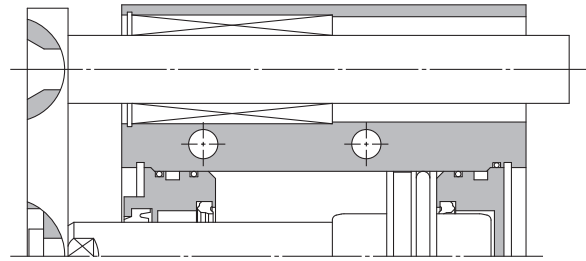
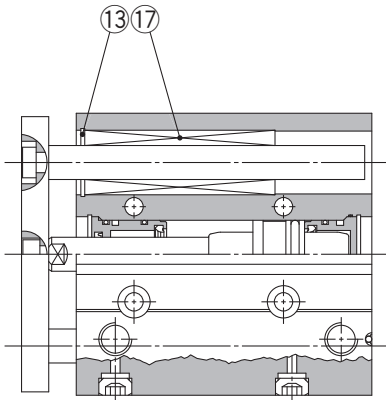

$\varnothing$  50 or more

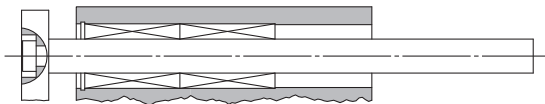

$\varnothing$  16 75 stroke or less

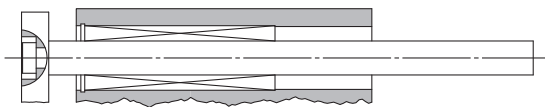

$\varnothing$  20 to  $\varnothing$  63 75 stroke or less

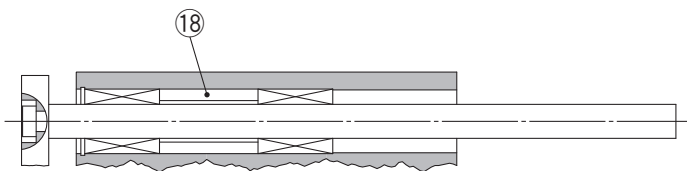

$\varnothing$  16 to  $\varnothing$  63 100 stroke or more  
 $\varnothing$  80,  $\varnothing$  100 250 stroke or more

Basic Type  
**MGP-Z**

With Air Cushion  
**MGP-AZ**

With End Lock  
**MGP**

Heavy Duty Guide Rod Type  
**MGPS**

**Auto Switch**

**Made to Order**

# Series MGP

## Ø 16 to Ø 25/MGPM, MGPL, MGPA (With Air Cushion)

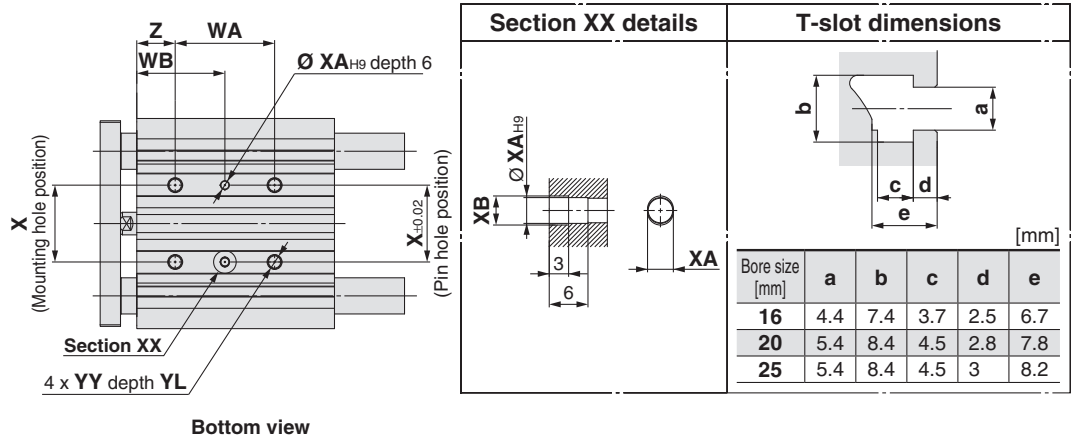

Bottom view

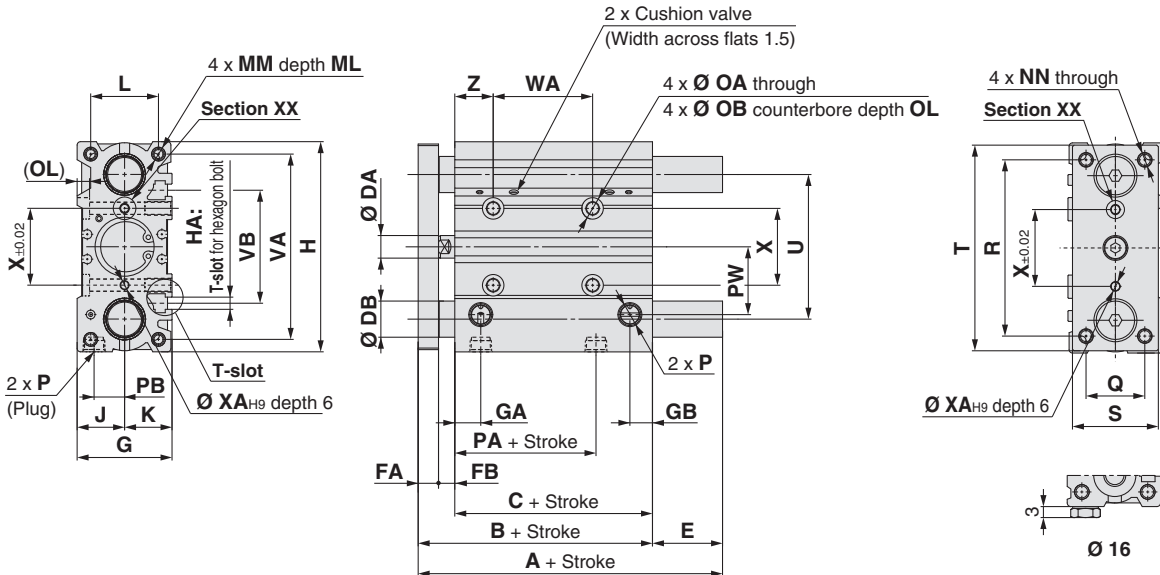

- \*: The use of a slot (width XA, length XB, depth 3) allows for a relaxed pin pitch tolerance, with the pin hole (Ø XAH9, depth 6) as the reference, without affecting mounting accuracy.
- \*: For intermediate strokes other than standard strokes, refer to Manufacture of Intermediate Strokes on page 30.
- \*: For bore size Ø 16, only M5 x 0.8 port is available.
- \*: For bore size Ø 20 or more, choice of Rc, NPT, G port is available. (Refer to page 29.)

### MGPM, MGPL Common Dimensions

Bore size [mm]	Standard stroke [mm]	B	C	DA	FA	FB	G	GA	GB	H	HA	J	K	L	MM	ML	NN	OA	OB	OL	P		
																					—	TN	TF
16	25, 50, 75, 100, 125, 150, 175, 200, 250	71	58	8	7	6	30	10.5	7.5	64	M4	15	15	22	M5 x 0.8	12	M5 x 0.8	4.3	8	4.5	M5 x 0.8	—	—
20	25, 50, 75, 100, 125, 150, 175	78	62	10	8	8	36	11.5	9	83	M5	18	18	24	M5 x 0.8	13	M5 x 0.8	5.4	9.5	5.5	Rc 1/8	NPT 1/8	G 1/8
25	200, 250, 300, 350, 400	78.5	62.5	10	9	7	42	11.5	10	93	M5	21	21	30	M6 x 1.0	15	M6 x 1.0	5.4	9.5	5.5	Rc 1/8	NPT 1/8	G 1/8

Bore size [mm]	PA	PB	PW	Q	R	S	T	U	VA	VB	WA				WB				X	XA	XB	YY	YL	Z
											75 st or less	100 to 175 st	200, 250 st	300 st or more	75 st or less	100 to 175 st	200, 250 st	300 st or more						
16	39.5	10	19	16	54	25	62	46	56	38	44	110	200	—	27	60	105	—	24	3	3.5	M5 x 0.8	10	5
20	38.5	10.5	25	18	70	30	81	54	72	44	44	120	200	300	39	77	117	167	28	3	3.5	M6 x 1.0	12	17
25	37.5	13.5	30	26	78	38	91	64	82	50	44	120	200	300	39	77	117	167	34	4	4.5	M6 x 1.0	12	17

### MGPM (Slide bearing)/A, DB, E Dimensions

Bore size [mm]	A			DB	E		
	25 to 100 st	125 to 200 st	250 st or more		25 to 100 st	125 to 200 st	250 st or more
16	71	92.5	92.5	10	0	21.5	21.5
20	78	78	110	12	0	0	32
25	78.5	78.5	109.5	16	0	0	31

### MGPL (Ball bushing)

### MGPA (High precision ball bushing)/A, DB, E Dimensions

Bore size [mm]	A			DB	E		
	25 to 75 st	100 to 200 st	250 st or more		25 to 75 st	100 to 200 st	250 st or more
16	71	94.5	94.5	8	0	23.5	23.5
20	78	100	117.5	10	0	22	39.5
25	81.5	100.5	117.5	13	3	22	39

**Ø 32 to Ø 63/MGPM, MGPL, MGPA (With Air Cushion)**

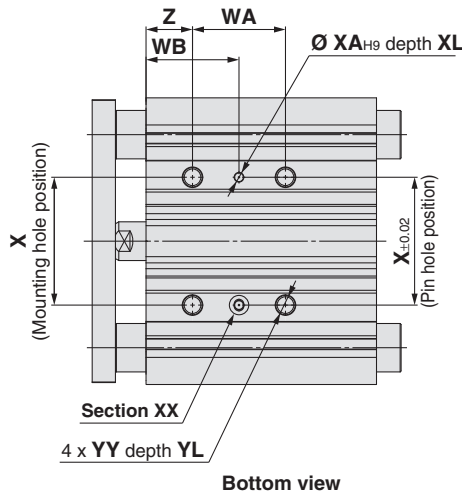
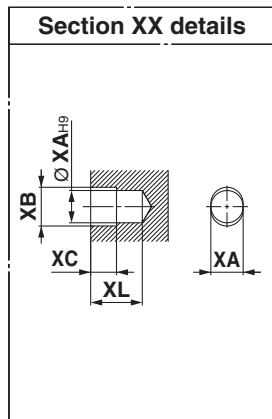

**T-slot dimensions**

Bore size [mm]	a	b	c	d	e
32	6.5	10.5	5.5	3.5	9.5
40	6.5	10.5	5.5	4	11
50	8.5	13.5	7.5	4.5	13.5
63	11	17.8	10	7	18.5

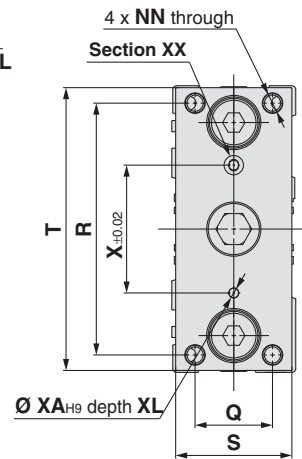
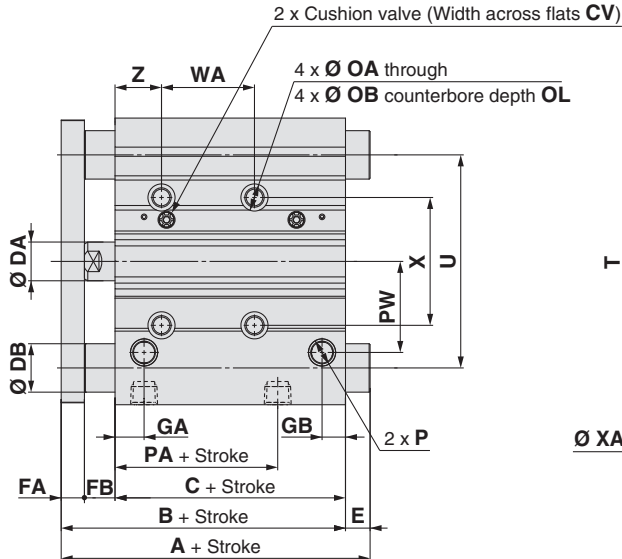
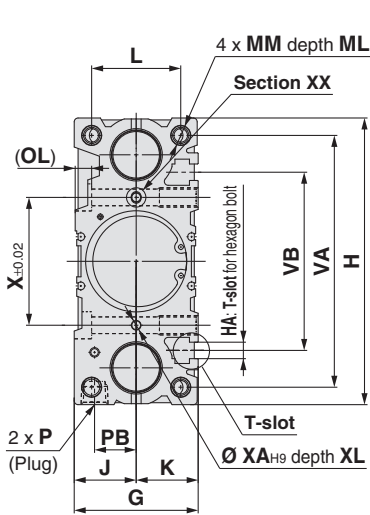

- \*: The use of a slot (width XA, length XB, depth XC) allows for a relaxed pin pitch tolerance, with the pin hole (Ø XAH9, depth XL) as the reference, without affecting mounting accuracy.
- \*: For intermediate strokes other than standard strokes, refer to Manufacture of Intermediate Strokes on page 30.
- \*: Choice of Rc, NPT, G port is available. (Refer to page 29.)

**MGPM, MGPL Common Dimensions**

Bore size [mm]	Standard stroke [mm]	B	C	CV	DA	FA	FB	G	GA	GB	H	HA	J	K	L	MM	ML	NN	OA	OB	OL	P		
																						—	TN	TF
32	25, 50, 75, 100	84.5	62.5	1.5	14	10	12	48	12	9	112	M6	24	24	34	M8 x 1.25	20	M8 x 1.25	6.7	11	7.5	Rc 1/8	NPT 1/8	G 1/8
40	125, 150, 175	91	69	1.5	14	10	12	54	15	12	120	M6	27	27	40	M8 x 1.25	20	M8 x 1.25	6.7	11	7.5	Rc 1/8	NPT 1/8	G 1/8
50	200, 250, 300	97	69	3	20	12	16	64	15	12	148	M8	32	32	46	M10 x 1.5	22	M10 x 1.5	8.6	14	9	Rc 1/4	NPT 1/4	G 1/4
63	350, 400	102	74	3	20	12	16	78	15.5	13.5	162	M10	39	39	58	M10 x 1.5	22	M10 x 1.5	8.6	—	9	Rc 1/4	NPT 1/4	G 1/4

Bore size [mm]	PA	PB	PW	Q	R	S	T	U	VA	VB	WA				WB				X	XA	XB	XC	XL	YY	YL	Z
											75 st or less	100 to 175 st	200, 250 st	300 st or more	75 st or less	100 to 175 st	200, 250 st	300 st or more								
32	31.5	16	35.5	30	96	44	110	78	98	63	48	124	200	300	45	83	121	171	42	4	4.5	3	6	M8 x 1.25	16	21
40	38	18	39.5	30	104	44	118	86	106	72	48	124	200	300	46	84	122	172	50	4	4.5	3	6	M8 x 1.25	16	22
50	34	21.5	47	40	130	60	146	110	130	92	48	124	200	300	48	86	124	174	66	5	6	4	8	M10 x 1.5	20	24
63	38	28	58	50	130	70	158	124	142	110	52	128	200	300	50	88	124	174	80	5	6	4	8	M10 x 1.5	20	24

**MGPL (Ball bushing)**

**MGPA (High precision ball bushing)/A, DB, E Dimensions [mm]**

**MGPM (Slide bearing)/A, DB, E Dimensions [mm]**

Bore size [mm]	A			DB	E		
	25 st	50 to 200 st	250 st or more		25 st	50 to 200 st	250 st or more
32	84.5	93.5	129.5	20	0	9	45
40	91	93.5	129.5	20	0	2.5	38.5
50	97	109.5	150.5	25	0	12.5	53.5
63	102	109.5	150.5	25	0	7.5	48.5

Bore size [mm]	A				DB	E			
	25 st	50, 75 st	100 to 200 st	250 st or more		25 st	50, 75 st	100 to 200 st	250 st or more
32	84.5	96.5	116.5	138.5	16	0	12	32	54
40	91	96.5	116.5	138.5	16	0	5.5	25.5	47.5
50	97	112.5	132.5	159.5	20	0	15.5	35.5	62.5
63	102	112.5	132.5	159.5	20	0	10.5	30.5	57.5

Basic Type  
**MGP-Z**

With Air Cushion  
**MGP-AZ**

With End Lock  
**MGP**

Heavy Duty Guide Rod Type  
**MGPS**

Auto Switch

Made to Order

# Series MGP

## Ø 80, Ø 100/MGPM, MGPL, MGPA (With Air Cushion)

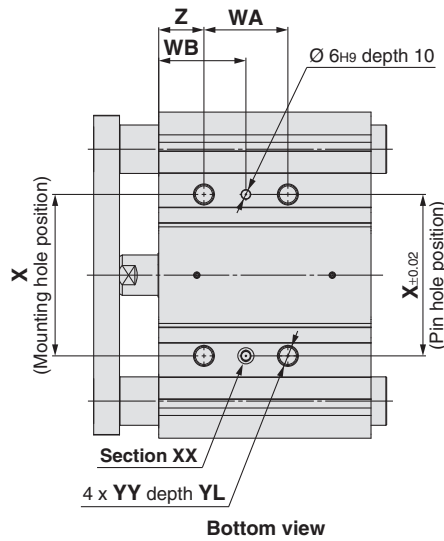
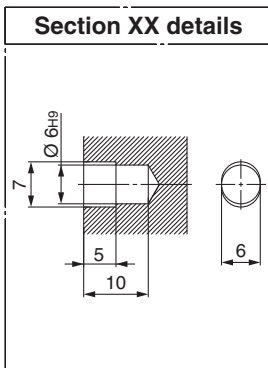

T-slot dimensions					
[mm]					
Bore size [mm]	a	b	c	d	e
80	13.3	20.3	12	8	22.5
100	15.3	23.3	13.5	10	30

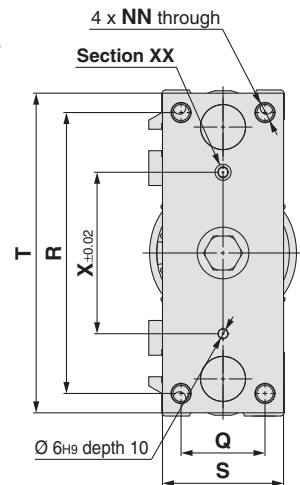
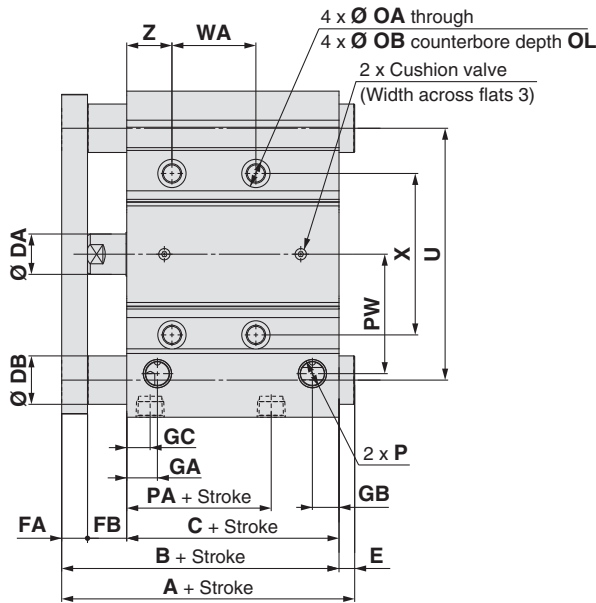
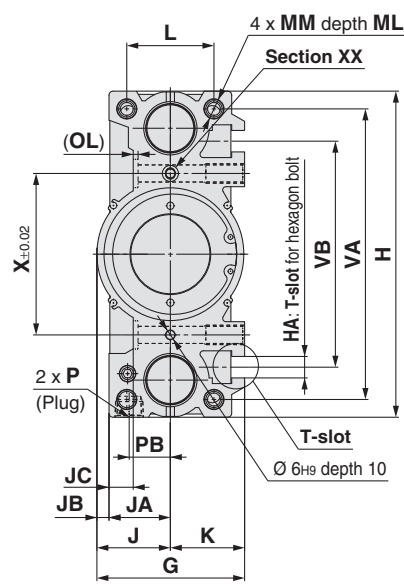

- \*: The use of a slot (width X6, length 7, depth 5) allows for a relaxed pin pitch tolerance, with the pin hole (Ø 6H9, depth 10) as the reference, without affecting mounting accuracy.
- \*: For intermediate strokes other than standard strokes, refer to Manufacture of Intermediate Strokes on page 30.
- \*: Choice of Rc, NPT, G port is available. (Refer to page 29.)

### MGPM, MGPL Common Dimensions [mm]

Bore size [mm]	Standard stroke [mm]	B	C	DA	FA	FB	G	GA	GB	GC	H	HA	J	JA	JB	JC	K	L	MM	ML	NN	OA	OB	OL	P		
																									—	TN	TF
80	50, 75, 100, 125, 150, 175	121.5	81.5	25	16	24	91.5	19	16.5	14.5	202	M12	45.5	38	7.5	15	46	54	M12 x 1.75	25	M12 x 1.75	10.6	17.5	3	Rc 3/8	NPT 3/8	G 3/8
100	200, 250, 300, 350, 400	141	91	30	19	31	111.5	22.5	20.5	18	240	M14	55.5	45	10.5	10	56	62	M14 x 2.0	31	M14 x 2.0	12.5	20	8	Rc 3/8	NPT 3/8	G 3/8

Bore size [mm]	PA	PB	PW	Q	R	S	T	U	VA	VB	WA				WB				X	YY	YL	Z
											50, 75 st	100 to 175 st	200, 250 st	300 st or more	50, 75 st	100 to 175 st	200, 250 st	300 st or more				
80	39.5	25.5	74	52	174	75	198	156	180	140	52	128	200	300	54	92	128	178	100	M12 x 1.75	24	28
100	42.5	32.5	89	64	210	90	236	188	210	166	72	148	220	320	47	85	121	171	124	M14 x 2.0	28	11

### MGPM (Slide bearing)/A, DB, E Dimensions [mm]

Bore size [mm]	A		DB	E	
	50 to 200 st	250 st or more		50 to 200 st	250 st or more
80	131.5	180.5	30	10	59
100	151.5	190.5	36	10.5	49.5

### MGPL (Ball bushing)

### MGPA (High precision ball bushing)/A, DB, E Dimensions [mm]

Bore size [mm]	A		DB	E	
	50 to 200 st	250 st or more		50 to 200 st	250 st or more
80	158.5	191.5	25	37	70
100	178.5	201.5	30	37.5	60.5

# Compact Guide Cylinder/With End Lock

## Series MGP

∅ 20, ∅ 25, ∅ 32, ∅ 40, ∅ 50, ∅ 63, ∅ 80, ∅ 100

### How to Order

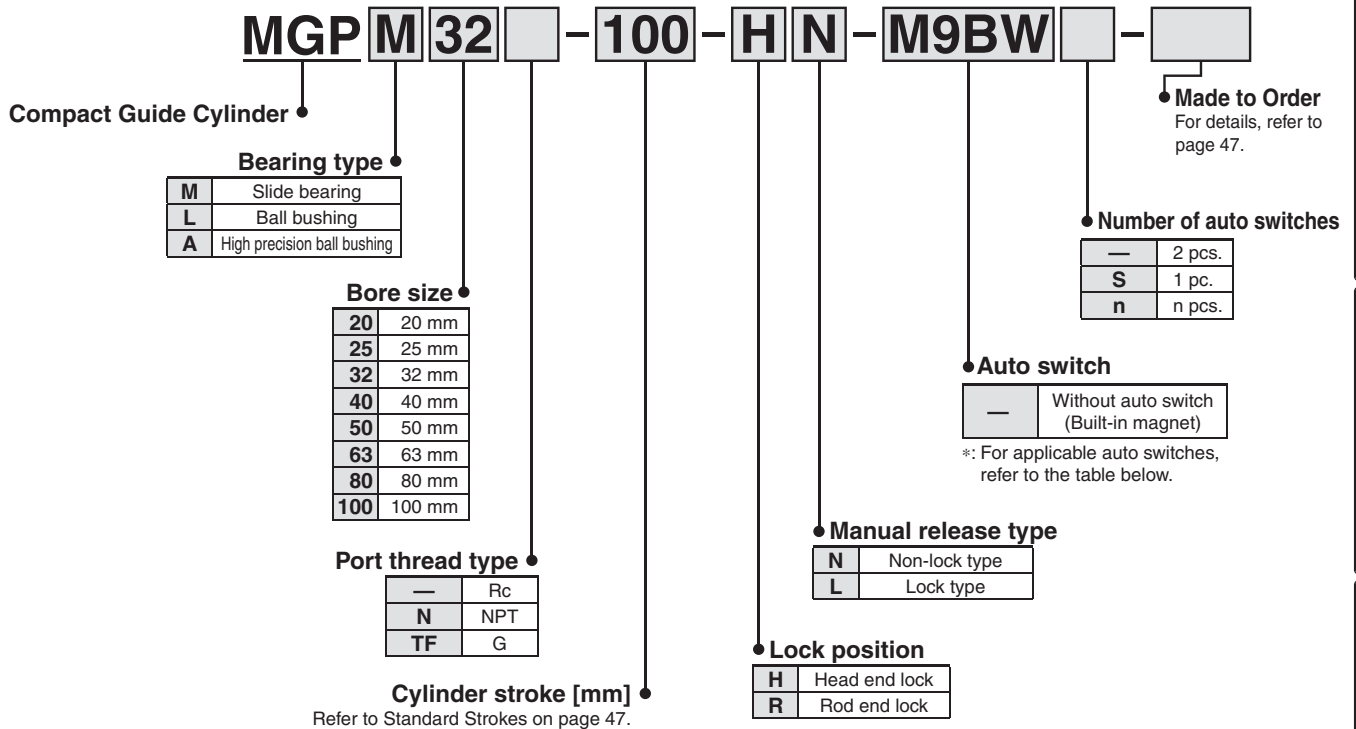

### Applicable Auto Switches/Refer to the Auto Switch Guide for further information on auto switches.

Type	Special function	Electrical entry	Indicator light	Wiring (Output)	Load voltage		Auto switch model		Lead wire length [m]				Pre-wired connector	Applicable load			
					DC	AC	Perpendicular	In-line	0.5 (—)	1 (M)	3 (L)	5 (Z)					
Solid state auto switch	—	Grommet	Yes	3-wire (NPN)	24 V	5 V, 12 V	—	M9NV	M9N	●	●	●	○	○	IC circuit	Relay, PLC	
				3-wire (PNP)				M9PV	M9P	●	●	●	○	○			
				2-wire	M9BV	M9B	●	●	●	○	○	○					
	Diagnostic indication (2-colour indication)			3-wire (NPN)	24 V	5 V, 12 V	—	M9NWV	M9NW	●	●	●	○	○	○		IC circuit
				3-wire (PNP)				M9PWV	M9PW	●	●	●	○	○	○		
				2-wire	M9BWW	M9BW	●	●	●	○	○	○	○				
	Water resistant (2-colour indication)			3-wire (NPN)	24 V	5 V, 12 V	—	M9NAV*1	M9NA*1	○	○	●	○	○	○		IC circuit
				3-wire (PNP)				M9PAV*1	M9PA*1	○	○	●	○	○	○		
Magnetic field resistant (2-colour indication)	2-wire	24 V	12 V	—	M9BAV*1	M9BA*1	○	○	●	○	○	○	—				
	2-wire (Non-polar)				—	P3DWA	●	—	●	●	○	○					
Reed auto switch	—	Grommet	No	3-wire (NPN equivalent)	24 V	12 V	100 V or less	A96V	A96	●	—	●	—	—	IC circuit	—	
				2-wire				A93V*2	A93	●	●	●	●	—	—	—	Relay, PLC
								A90V	A90	●	—	●	—	—	IC circuit	PLC	

\*1: Water resistant type auto switches can be mounted on the above models, but in such case SMC cannot guarantee water resistance.

Please consult with SMC regarding water resistant types with the above model numbers.

\*2: 1 m type lead wire is only applicable to the D-A93.

\*: Lead wire length symbols: 0.5 m..... — (Example) M9NW  
 1 m..... M (Example) M9NWM  
 3 m..... L (Example) M9NWL  
 5 m..... Z (Example) M9NWZ

\*: Solid state auto switches marked with "○" are produced upon receipt of order.

\*: Bore sizes 32 to 100 are available for D-P4DW□.

\*: Bore sizes 25 to 100 are available for D-P3DWA□.

\*: Since there are other applicable auto switches than listed above, refer to page 66 for details.

\*: For details about auto switches with pre-wired connector, refer to the Auto Switch Guide.

For D-P3DWA□, refer to the Auto Switch Guide.

\*: Auto switches are shipped together, (but not assembled).

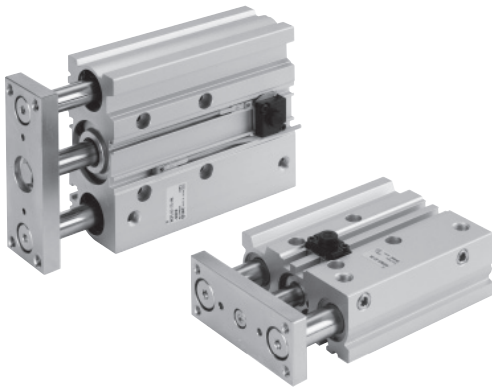

**Symbol**  
Rubber bumper

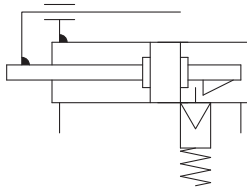

**Made to Order**  
(For details, refer to pages 72 and 89.)

Symbol	Specifications
-XC79	Tapped hole, drilled hole, pinned hole machined additionally *1
-X867	Side porting type (Plug location changed) *1

\*1: The shape is the same as the current product.

Refer to pages 63 to 67 for cylinders with auto switches.

- Minimum stroke for auto switch mounting
- Auto switch proper mounting position (detection at stroke end) and its mounting height
- Operating range
- Auto switch mounting brackets/Part no.
- Auto switch mounting

## Specifications

Bore size [mm]	20	25	32	40	50	63	80	100
<b>Action</b>	Double acting							
<b>Fluid</b>	Air							
<b>Proof pressure</b>	1.5 MPa							
<b>Maximum operating pressure</b>	1.0 MPa							
<b>Minimum operating pressure</b>	0.15 MPa *1							
<b>Ambient and fluid temperature</b>	-10 to 60 °C (No freezing)							
<b>Piston speed</b> *2	50 to 500 mm/s						50 to 400 mm/s	
<b>Cushion</b>	Rubber bumper on both ends							
<b>Lubrication</b>	Not required (Non-lube)							
<b>Stroke length tolerance</b>	$+1.5$ $+0$ mm							

\*1: 0.1 MPa except the lock unit.

\*2: Maximum speed with no load. Depending on the operating conditions, the piston speed may not be satisfied. Make a model selection, considering a load according to the graph on pages 16 to 22.

## Lock Specifications

Lock position	Head end, Rod end							
<b>Holding force (Max.) N</b>	Ø 20	Ø 25	Ø 32	Ø 40	Ø 50	Ø 63	Ø 80	Ø 100
	215	330	550	860	1340	2140	3450	5390
<b>Backlash</b>	2 mm or less							
<b>Manual release</b>	Non-lock type, Lock type							

Adjust switch positions for operation at both the stroke end and backlash (2 mm) movement positions.

## Standard Strokes

Bore size [mm]	Standard stroke [mm]
20, 25, 32, 40, 50, 63, 80, 100	25, 50, 75, 100, 125, 150, 175, 200, 250, 300, 350, 400

## Manufacture of Intermediate Stroke

<b>Description</b>	Spacer installation type. Dealing with the stroke in 5 mm increments is available by installing spacer with standard stroke cylinder. When a spacer is mounted on the cylinder with an end lock on the rod side, use a special piston rod.
<b>Part no.</b>	Refer to "How to Order" for the standard model numbers on page 46.
<b>Applicable stroke [mm]</b>	5 to 395
<b>Example</b>	Part no.: MGPM50-35-HN A spacer 15 mm in width is installed in a MGPM50-50-HN. C dimension is 119 mm.

\*: The minimum stroke for mounting auto switches is 10 stroke or more for two switches, and 5 stroke or more for one switch.  
\*: Intermediate stroke (in 1 mm increments) based on an exclusive body will be available upon request for special.

## Theoretical Output



Bore size [mm]	Rod size [mm]	Operating direction	Piston area [mm <sup>2</sup> ]	Operating pressure [MPa]								
				0.2	0.3	0.4	0.5	0.6	0.7	0.8	0.9	1.0
20	10	OUT	314	63	94	126	157	188	220	251	283	314
		IN	236	47	71	94	118	142	165	189	212	236
25	12	OUT	491	98	147	196	246	295	344	393	442	491
		IN	378	76	113	151	189	227	265	302	340	378
32	16	OUT	804	161	241	322	402	482	563	643	724	804
		IN	603	121	181	241	302	362	422	482	543	603
40	16	OUT	1257	251	377	503	629	754	880	1006	1131	1257
		IN	1056	211	317	422	528	634	739	845	950	1056
50	20	OUT	1963	393	589	785	982	1178	1374	1570	1767	1963
		IN	1649	330	495	660	825	990	1154	1319	1484	1649
63	20	OUT	3117	623	935	1247	1559	1870	2182	2494	2805	3117
		IN	2803	561	841	1121	1402	1682	1962	2242	2523	2803
80	25	OUT	5027	1005	1508	2011	2514	3016	3519	4022	4524	5027
		IN	4536	907	1361	1814	2268	2722	3175	3629	4082	4536
100	30	OUT	7854	1571	2356	3142	3927	4712	5498	6283	7069	7854
		IN	7147	1429	2144	2859	3574	4288	5003	5718	6432	7147

\*: Theoretical output [N] = Pressure [MPa] x Piston area [mm<sup>2</sup>]



## Weights

### Slide Bearing: MGPM20 to 100 (Basic weight)

Bore size [mm]	Standard stroke [mm]											
	25	50	75	100	125	150	175	200	250	300	350	400
20	0.86	1.12	1.32	1.52	1.71	1.91	2.11	2.31	2.78	3.18	3.57	3.97
25	1.18	1.56	1.83	2.10	2.38	2.65	2.92	3.19	3.85	4.39	4.94	5.48
32	1.92	2.32	2.70	3.09	3.47	3.85	4.23	4.61	5.56	6.32	7.09	7.85
40	2.20	2.66	3.08	3.51	3.93	4.36	4.78	5.20	6.24	7.10	7.95	8.80
50	3.73	4.46	5.10	5.74	6.38	7.02	7.66	8.30	9.91	11.2	12.5	13.8
63	4.61	5.45	6.21	6.96	7.72	8.47	9.23	9.99	11.8	13.3	14.8	16.3
80	7.88	8.70	9.49	10.3	11.2	12.0	12.8	13.9	15.5	17.2	18.8	20.5
100	12.1	13.2	14.4	15.6	16.8	18.0	19.1	20.6	22.9	25.3	27.6	30.0

### Ball Bushing, High Precision Ball Bushing: MGPA20 to 100 (Basic weight)

Bore size [mm]	Standard stroke [mm]											
	25	50	75	100	125	150	175	200	250	300	350	400
20	0.93	1.10	1.27	1.48	1.65	1.83	2.00	2.17	2.55	2.90	3.25	3.60
25	1.27	1.50	1.74	2.01	2.24	2.47	2.70	2.94	3.44	3.91	4.37	4.83
32	1.74	2.19	2.51	2.88	3.20	3.51	3.83	4.15	4.84	5.47	6.10	6.73
40	2.02	2.51	2.87	3.29	3.65	4.01	4.37	4.73	5.51	6.23	6.95	7.67
50	3.46	4.21	4.76	5.40	5.95	6.50	7.05	7.60	8.83	9.92	11.1	12.2
63	4.33	5.20	5.86	6.62	7.28	7.95	8.61	9.27	10.7	12.1	13.4	14.7
80	8.05	8.87	9.66	10.5	11.4	12.2	13.0	14.1	15.7	17.4	19.0	20.7
100	12.4	13.5	14.7	15.9	17.1	18.3	19.4	20.9	23.2	25.6	27.9	30.3

### Lock Unit Additional Weight

Bore size [mm]	Head end lock		Rod end lock	
	HN	HL	RN	RL
20	0.05	0.07	0.05	0.06
25	0.06	0.07	0.05	0.07
32	0.09	0.10	0.09	0.10
40	0.15	0.18	0.14	0.18
50	0.24	0.27	0.23	0.27

Bore size [mm]	Head end lock		Rod end lock	
	HN	HL	RN	RL
63	0.36	0.40	0.35	0.39
80	0.90	0.97	1.03	1.10
100	1.52	1.60	1.60	1.68

Calculation: (Example) **MGPM50-100-HN**  
 • Basic Weight + Lock unit additional weight  
 • 5.74 + 0.24 = 5.98 kg

### Allowable Rotational Torque of Plate

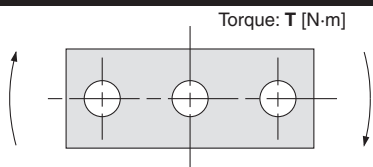

Bore size [mm]	Bearing type	Stroke [mm]											
		25	50	75	100	125	150	175	200	250	300	350	400
20	MGPM	0.99	0.75	1.88	1.63	1.44	1.28	1.16	1.06	0.90	0.78	0.69	0.62
	MGPL/A	2.66	1.94	1.52	1.25	1.34	1.17	1.03	0.93	0.76	0.65	0.56	0.49
25	MGPM	1.64	1.25	2.96	2.57	2.26	2.02	1.83	1.67	1.42	1.24	1.09	0.98
	MGPL/A	4.08	3.02	2.38	1.97	2.05	1.78	1.58	1.41	1.16	0.98	0.85	0.74
32	MGPM	6.35	5.13	5.69	4.97	4.42	3.98	3.61	3.31	2.84	2.48	2.20	1.98
	MGPL/A	5.95	4.89	5.11	4.51	6.34	5.79	5.33	4.93	4.29	3.78	3.38	3.04
40	MGPM	7.00	5.66	6.27	5.48	4.87	4.38	5.98	3.65	3.13	2.74	2.43	2.19
	MGPL/A	6.55	5.39	5.62	4.96	6.98	6.38	5.87	5.43	4.72	4.16	3.71	3.35
50	MGPM	13.0	10.8	12.0	10.6	9.50	8.60	7.86	7.24	6.24	5.49	4.90	4.43
	MGPL/A	9.17	7.62	9.83	8.74	11.6	10.7	9.83	9.12	7.95	7.02	6.26	5.63
63	MGPM	14.7	12.1	13.5	11.9	10.7	9.69	8.86	8.16	7.04	6.19	5.52	4.99
	MGPL/A	10.2	8.48	11.0	9.74	13.0	11.9	11.0	10.2	8.84	7.80	6.94	6.24
80	MGPM	21.9	18.6	22.9	20.5	18.6	17.0	15.6	14.5	12.6	11.2	10.0	9.11
	MGPL/A	15.1	23.3	22.7	20.6	18.9	17.3	16.0	14.8	12.9	11.3	10.0	8.94
100	MGPM	38.8	33.5	37.5	33.8	30.9	28.4	26.2	24.4	21.4	19.1	17.2	15.7
	MGPL/A	27.1	30.6	37.9	34.6	31.8	29.3	27.2	25.3	22.1	19.5	17.3	15.5

### Non-rotating Accuracy of Plate

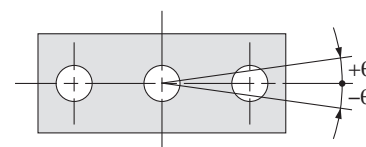

For non-rotating accuracy  $\theta$  without load, use a value no more than the values in the table as a guide.

Bore size [mm]	Non-rotating accuracy $\theta$		
	MGPM	MGPL	MGPA
20	$\pm 0.07^\circ$	$\pm 0.09^\circ$	$\pm 0.01^\circ$
25	$\pm 0.07^\circ$	$\pm 0.09^\circ$	
32	$\pm 0.06^\circ$	$\pm 0.08^\circ$	
40	$\pm 0.06^\circ$	$\pm 0.08^\circ$	
50	$\pm 0.05^\circ$	$\pm 0.06^\circ$	
63	$\pm 0.05^\circ$	$\pm 0.06^\circ$	
80	$\pm 0.04^\circ$	$\pm 0.05^\circ$	
100	$\pm 0.04^\circ$	$\pm 0.05^\circ$	

### Model selection

Model selection is the same as MGP/  
standard type.  
Refer to pages 16 to 23.

Basic Type  
**MGP-Z**

With Air Cushion  
**MGP-AZ**

With End Lock  
**MGP**

Heavy Duty Guide Rod Type  
**MGPS**

Auto Switch

Made to Order

# Series MGP

## Construction/Series MGPM

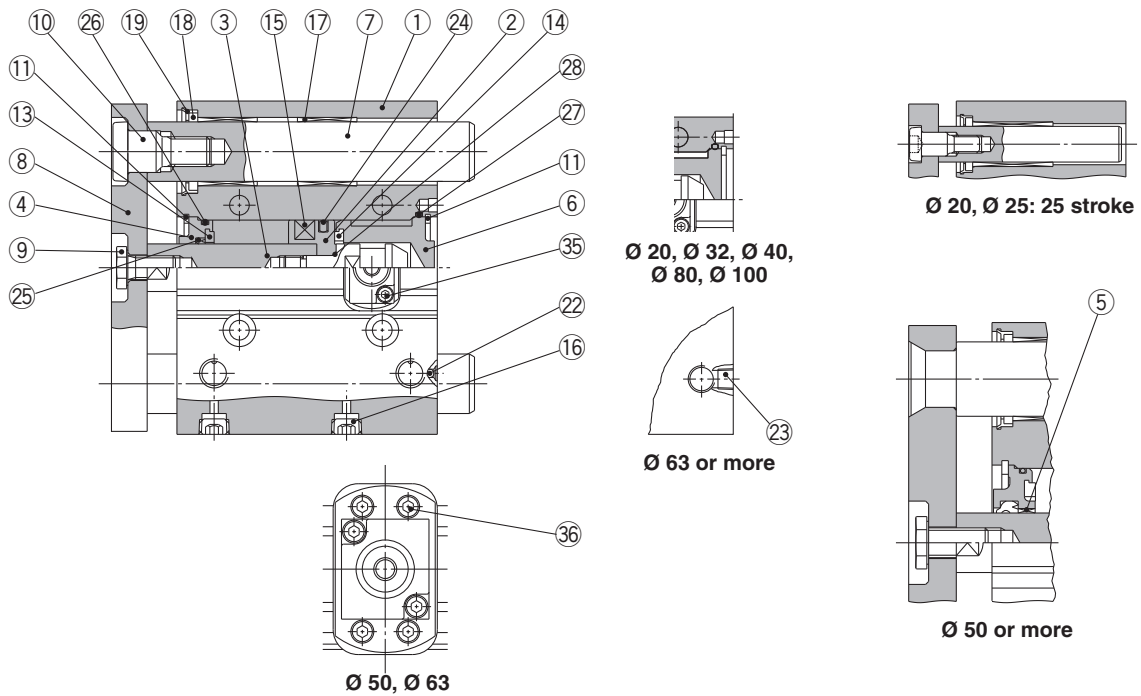

### Non-locking type

(Head end lock)

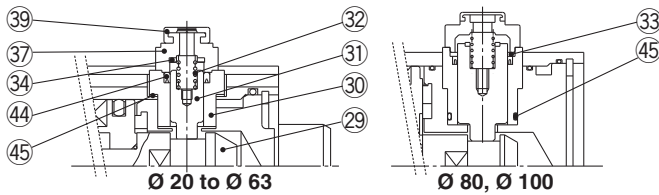

(Rod end lock)

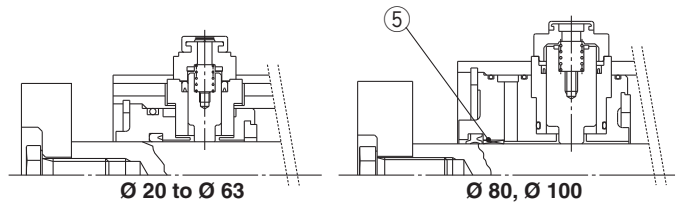

### Component Parts

No.	Description	Material	Note
1	Body	Aluminium alloy	Hard anodised
2	Piston	Aluminium alloy	
3	Piston rod	Stainless steel Ø 20, Ø 25 Carbon steel Ø 32 to Ø 100	Hard chrome plating with rod end lock only Hard chrome plating
4	Collar	Aluminium alloy	Chromated
5	Bushing	Bearing alloy	
6	Head cover	Aluminium alloy	Chromated
7	Guide rod	Carbon steel	Hard chrome plating
8	Plate	Carbon steel	Nickel plating
9	Plate mounting bolt	Carbon steel	Nickel plating
10	Guide bolt	Carbon steel	Nickel plating
11	Retaining ring	Carbon tool steel	Phosphate coated
12	Retaining ring	Carbon tool steel	Phosphate coated
13	Bumper A	Urethane	
14	Bumper B	Urethane	
15	Magnet	—	
16	Hexagon socket head cap plug	Carbon steel	Nickel plating
17	Slide Bearing	Bearing alloy	
18	Felt	Felt	
19	Holder	Resin	
20	Ball bushing		
21	Spacer	Aluminium alloy	
22	Steel ball	Carbon steel	Ø 20 to Ø 50
23	Plug	Carbon steel	Ø 63 to Ø 100 Nickel plating
24*	Piston seal	NBR	
25*	Rod seal	NBR	
26*	Gasket A	NBR	
27*	Gasket B	NBR	

### Component Parts

No.	Description	Material	Note
28	Piston gasket	NBR	Ø 32 to Ø 100 only
29	Lock bolt	Carbon steel	Zinc chromated
30	Lock holder	Brass	Electroless nickel plating
31	Lock piston	Carbon steel	Hard chrome plating
32	Lock spring	Stainless steel	
33	Seal retainer	Carbon steel	Zinc chromated (Ø 80, Ø 100 only)
34	Bumper	Urethane	
35*	Hexagon socket head cap screw	Carbon steel	Black zinc chromated
36*	Hexagon socket head cap screw	Carbon steel	Zinc chromated (Ø 50, Ø 63 only)
37	Cap A	Aluminium die-casted	Black painted
38	Cap B	Carbon steel	SQ treated
39	Rubber cap	Synthetic rubber	
40	M/O knob	Zinc die-casted	Black painted
41	M/O bolt	Alloy steel	Black zinc chromated
42	M/O spring	Steel wire	chromated
43	Stopper ring	Carbon steel	chromated
44*	Lock piston seal	NBR	
45*	Lock holder gasket	NBR	

### Replacement Parts/Seal Kit

Bore size [mm]	Kit no.	Contents	Bore size [mm]	Kit no.	Contents
20	MGP20-B-PS	Set of nos. above	50	MGP50-B-PS	Set of nos. 24, 25, 26, 27, 35, 36, 44, 45
25	MGP25-B-PS	Set of nos. above	63	MGP63-B-PS	Set of nos. 24, 25, 26, 27, 35, 44, 45
32	MGP32-B-PS	24, 25, 26, 27, 35, 44, 45	80	MGP80-B-PS	Set of nos. 24, 25, 26, 27, 35, 44, 45
40	MGP40-B-PS	35, 44, 45	100	MGP100-B-PS	Set of nos. 24, 25, 26, 27, 35, 44, 45

\*: Each seal kit includes the parts listed above. Order the seal kit based on each bore size.

\*: Since the seal kit does not include a grease pack, order it separately.  
Grease pack part no.: GR-S-010 (10 g)

**Construction/Series MGPL, MGPA**

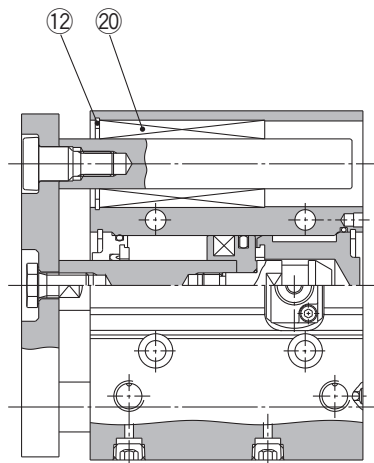

Ø 20, Ø 32, Ø 40,  
Ø 80, Ø 100

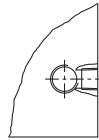

Ø 63 or more

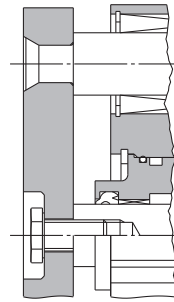

Ø 50 or more

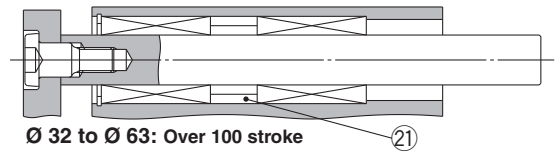

Ø 32 to Ø 63: Over 100 stroke

**Lock type**

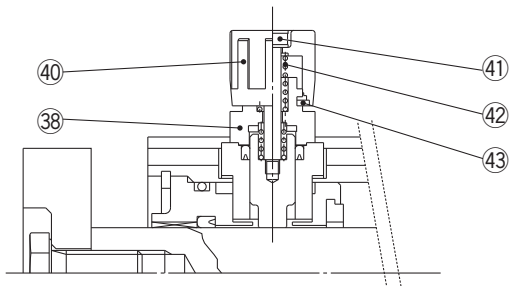

Basic Type  
**MGP-Z**

With Air Cushion  
**MGP-AZ**

With End Lock  
**MGP**

Heavy Duty Guide Rod Type  
**MGPS**

**Auto Switch**

**Made to Order**

Dimensions:  $\varnothing 32$  to  $\varnothing 63$

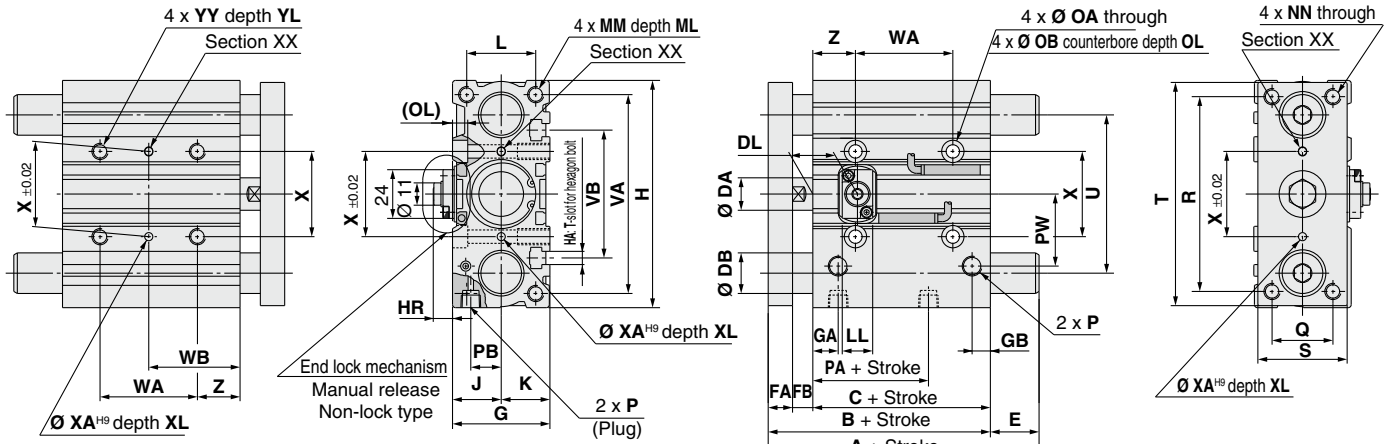

With rod end lock

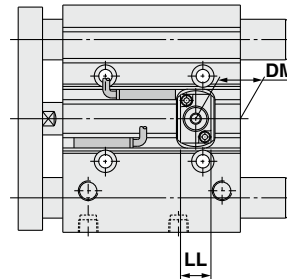

With head end lock

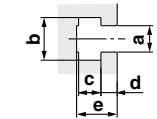

T-slot dimensions [mm]

Bore size [mm]	T-slot dimensions				
	a	b	c	d	e
32	6.5	10.5	5.5	3.5	9.5
40	6.5	10.5	5.5	4	11
50	8.5	13.5	7.5	4.5	13.5
63	11	17.8	10	7	18.5

End lock mechanism (Manual release lock type)

Detailed figure of section XX

\*: For intermediate strokes other than standard strokes, refer to the Manufacture of Intermediate Stroke on page 47.  
\*: Rc, NPT and G ports can be selected. (Refer to page 46.)

**MGPM, MGPL Common Dimensions** [mm]

Bore size [mm]	Standard stroke [mm]	B	C	DA	FA	FB	G	GA	GB	H	HA	J	K	L	MM	ML	NN	OA	OB	OL	P		
		—	N	TF																			
32	25, 50, 75 100, 125, 150 175, 200, 250 300, 350, 400	84.5	62.5	16	12	10	48	12.5	9	112	M6	24	24	34	M8 x 1.25	20	M8 x 1.25	6.6	11	7.5	Rc 1/8	NPT 1/8	G 1/8
40		91	69	16	12	10	54	14	10	120	M6	27	27	40	M8 x 1.25	20	M8 x 1.25	6.6	11	7.5	Rc 1/8	NPT 1/8	G 1/8
50		97	69	20	16	12	64	14	11	148	M8	32	32	46	M10 x 1.5	22	M10 x 1.5	8.6	14	9	Rc 1/4	NPT 1/4	G 1/4
63		102	74	20	16	12	78	16.5	13.5	162	M10	39	39	58	M10 x 1.5	22	M10 x 1.5	8.6	14	9	Rc 1/4	NPT 1/4	G 1/4

Bore size [mm]	PA	PB	PW	Q	R	S	T	U	VA	VB	WA				WB				X	XA	XB	XC	XL	YY	YL	Z
	75 st or less	Over 75 st to 175 st	Over 175 st to 250 st	Over 250 st	75 st or less	Over 75 st to 175 st	Over 175 st to 250 st	Over 250 st																		
32	32	15	35.5	30	96	44	110	78	98	63	48	124	200	300	45	83	121	171	42	4	4.5	3	6	M8 x 1.25	16	21
40	38	18	39.5	30	104	44	118	86	106	72	48	124	200	300	46	84	122	172	50	4	4.5	3	6	M8 x 1.25	16	22
50	34	21.5	47	40	130	60	146	110	130	92	48	124	200	300	48	86	124	174	66	5	6	4	8	M10 x 1.5	20	24
63	39	28	58	50	130	70	158	124	142	110	52	128	200	300	50	88	124	174	80	5	6	4	8	M10 x 1.5	20	24

**MGPM (Slide bearing)/A, DB, E Dimensions** [mm]

Bore size [mm]	A			DB	E		
	25 st or less	Over 25 st to 175 st	Over 175 st		25 st or less	Over 25 st to 175 st	Over 175 st
32	97	102	140	20	12.5	17.5	55.5
40	97	102	140	20	6	11	49
50	106.5	118	161	25	9.5	21	64
63	106.5	118	161	25	4.5	16	59

**MGPL (Ball bushing), MGPA (High precision ball bushing)/A, DB, E Dimensions** [mm]

Bore size [mm]	A				DB	E			
	25 st or less	Over 25 st to 75 st	Over 75 st to 175 st	Over 175 st		25 st or less	Over 25 st to 75 st	Over 75 st to 175 st	Over 175 st
32	84.5	98	118	140	16	0	13.5	33.5	55.5
40	91	98	118	140	16	0	7	27	49
50	97	114	134	161	20	0	17	37	64
63	102	114	134	161	20	0	12	32	59

**End Lock Mechanism Dimensions** [mm]

Bore size [mm]	DL	DM	HR	HN	LL	MO
32	22	22	9.5	21	15	15
40	26	23	11.5	25.5	21	19
50	24	23	13	27	21	19
63	25	25.5	11	25	21	19

Basic Type  
**MGP-Z**

With Air Cushion  
**MGP-AZ**

With End Lock  
**MGP**

Heavy Duty Guide Rod Type  
**MGPS**

Auto Switch

Made to Order

Dimensions:  $\varnothing 32$  to  $\varnothing 63$

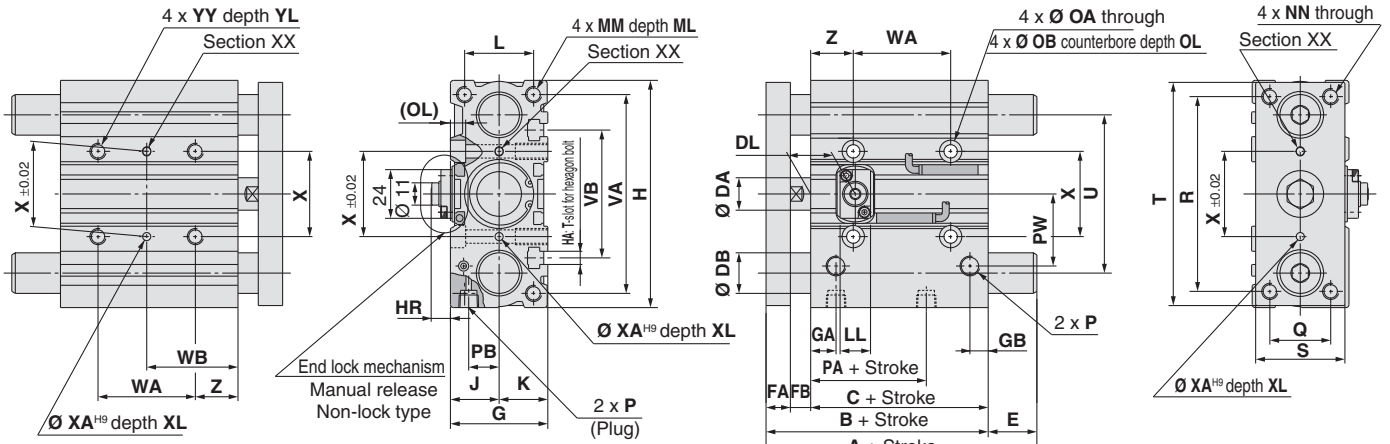

With rod end lock

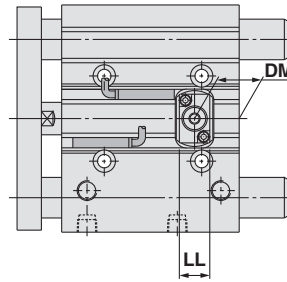

With head end lock

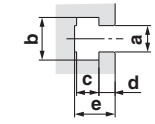

T-slot dimensions [mm]

Bore size [mm]	T-slot dimensions				
	a	b	c	d	e
32	6.5	10.5	5.5	3.5	9.5
40	6.5	10.5	5.5	4	11
50	8.5	13.5	7.5	4.5	13.5
63	11	17.8	10	7	18.5

End lock mechanism (Manual release lock type)

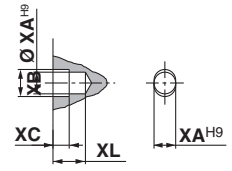
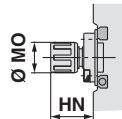

Detailed figure of section XX

\*: For intermediate strokes other than standard strokes, refer to the Manufacture of Intermediate Stroke on page 47.  
\*: Rc, NPT and G ports can be selected. (Refer to page 46.)

**MGPM, MGPL Common Dimensions** [mm]

Bore size [mm]	Standard stroke [mm]	B	C	DA	FA	FB	G	GA	GB	H	HA	J	K	L	MM	ML	NN	OA	OB	OL	P		
		—	N	TF																			
32	25, 50, 75 100, 125, 150	84.5	62.5	16	12	10	48	12.5	9	112	M6	24	24	34	M8 x 1.25	20	M8 x 1.25	6.6	11	7.5	Rc 1/8	NPT 1/8	G 1/8
40		91	69	16	12	10	54	14	10	120	M6	27	27	40	M8 x 1.25	20	M8 x 1.25	6.6	11	7.5	Rc 1/8	NPT 1/8	G 1/8
50	175, 200, 250 300, 350, 400	97	69	20	16	12	64	14	11	148	M8	32	32	46	M10 x 1.5	22	M10 x 1.5	8.6	14	9	Rc 1/4	NPT 1/4	G 1/4
63		102	74	20	16	12	78	16.5	13.5	162	M10	39	39	58	M10 x 1.5	22	M10 x 1.5	8.6	14	9	Rc 1/4	NPT 1/4	G 1/4

Bore size [mm]	PA	PB	PW	Q	R	S	T	U	VA	VB	WA				WB				X	XA	XB	XC	XL	YY	YL	Z
	75 st or less	Over 75 st to 175 st	Over 175 st to 250 st	Over 250 st	75 st or less	Over 75 st to 175 st	Over 175 st to 250 st	Over 250 st																		
32	32	15	35.5	30	96	44	110	78	98	63	48	124	200	300	45	83	121	171	42	4	4.5	3	6	M8 x 1.25	16	21
40	38	18	39.5	30	104	44	118	86	106	72	48	124	200	300	46	84	122	172	50	4	4.5	3	6	M8 x 1.25	16	22
50	34	21.5	47	40	130	60	146	110	130	92	48	124	200	300	48	86	124	174	66	5	6	4	8	M10 x 1.5	20	24
63	39	28	58	50	130	70	158	124	142	110	52	128	200	300	50	88	124	174	80	5	6	4	8	M10 x 1.5	20	24

**MGPM (Slide bearing)/A, DB, E Dimensions** [mm]

Bore size [mm]	A			DB	E		
	25 st or less	Over 25 st to 175 st	Over 175 st		25 st or less	Over 25 st to 175 st	Over 175 st
32	97	102	140	20	12.5	17.5	55.5
40	97	102	140	20	6	11	49
50	106.5	118	161	25	9.5	21	64
63	106.5	118	161	25	4.5	16	59

**MGPL (Ball bushing), MGPA (High precision ball bushing)/A, DB, E Dimensions** [mm]

Bore size [mm]	A				DB	E			
	25 st or less	Over 25 st to 175 st	Over 175 st to 250 st	Over 250 st		25 st or less	Over 25 st to 175 st	Over 175 st to 250 st	Over 250 st
32	84.5	98	118	140	16	0	13.5	33.5	55.5
40	91	98	118	140	16	0	7	27	49
50	97	114	134	161	20	0	17	37	64
63	102	114	134	161	20	0	12	32	59

**End Lock Mechanism Dimensions** [mm]

Bore size [mm]	DL	DM	HR	HN	LL	MO
32	22	22	9.5	21	15	15
40	26	23	11.5	25.5	21	19
50	24	23	13	27	21	19
63	25	25.5	11	25	21	19

Basic Type **MGP-Z**  
With Air Cushion **MGP-AZ**  
With End Lock **MGP**  
Heavy Duty Guide Rod Type **MGPS**  
Auto Switch  
Made to Order

# Series MGP

Dimensions:  $\varnothing 80, \varnothing 100$

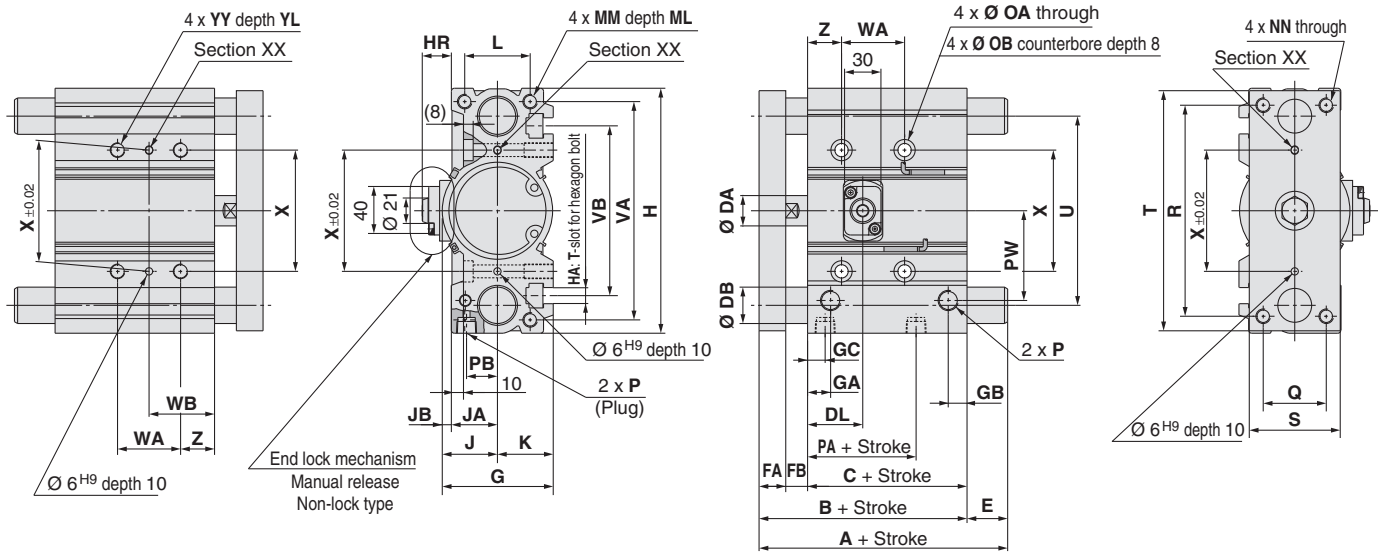

With rod end lock

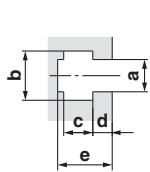

T-slot dimensions [mm]

Bore size [mm]	T-slot dimensions				
	a	b	c	d	e
80	13.3	20.3	12	8	22.5
100	15.3	23.3	13.5	10	30

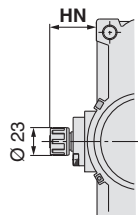

End lock mechanism (Manual release lock type)

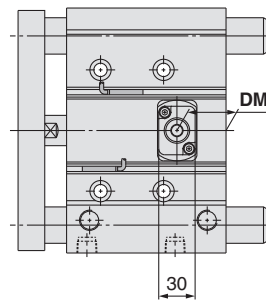

With head end lock

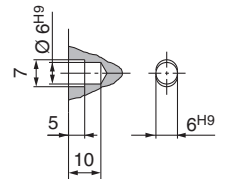

Detailed figure of section XX

\*: For intermediate strokes other than standard strokes, refer to the Manufacture of Intermediate Stroke on page 47.  
\*: Rc, NPT and G ports can be selected. (Refer to page 46.)

## MGPM, MGPL Common Dimensions

Bore size [mm]	Standard stroke [mm]	B	C	DA	FA	FB	G	GA	GB	GC	H	HA	J	JA	JB	K	L	MM	ML	NN	OA	OB
		80	25, 50, 75, 100, 125, 150, 175, 200, 250	146.5	106.5	25	22	18	91.5	19	15.5	14.5	202	M12	45.5	38	7.5	46	54	M12 x 1.75	25	M12 x 1.75
100	300, 350, 400	166	116	30	25	25	111.5	23	19	18	240	M14	55.5	45	10.5	56	62	M14 x 2.0	31	M14 x 2.0	12.5	20

Bore size [mm]	P			PA	PB	PW	Q	R	S	T	U	VA	VB	WA				WB				X	YY	YL	Z
	—	N	TF											50 st or less	Over 50 st to 150 st	Over 150 st to 250 st	Over 250 st	50 st or less	Over 50 st to 150 st	Over 150 st to 250 st	Over 250 st				
80	Rc 3/8	NPT 3/8	G3/8	64.5	25.5	74	52	174	75	198	156	180	140	52	128	200	300	54	92	128	178	100	M12 x 1.75	24	28
100	Rc 3/8	NPT 3/8	G3/8	67.5	32.5	89	64	210	90	236	188	210	166	72	148	220	320	47	85	121	171	124	M14 x 2.0	28	11

## MGPM (Slide bearing)/A, DB, E Dimensions [mm]

Bore size [mm]	A		DB	E	
	150 st or less	Over 150 st		150 st or less	Over 150 st
80	146.5	193	30	0	46.5
100	166	203	36	0	37

## MGPL (Ball bushing),

## MGPA (High precision ball bushing)/A, DB, E Dimensions [mm]

Bore size [mm]	A		DB	E	
	150 st or less	Over 150 st		150 st or less	Over 150 st
80	160	193	25	13.5	46.5
100	180	203	30	14	37

## End Lock Mechanism

### Dimensions [mm]

Bore size [mm]	DL	DM	HR	HN
80	45.5	40.5	24	38.5
100	49	43.5	26.5	41



# Series MGP With End Lock

## Specific Product Precautions

Be sure to read this before handling. Refer to the back cover for Safety Instructions. For Actuator and Auto Switch Precautions, refer to Handling Precautions for SMC Products and the Operation Manual on the SMC website, <http://www.smc.eu>

### Use Recommended Air Pressure Circuit.

#### ⚠ Caution

- It is necessary for proper locking and unlocking.

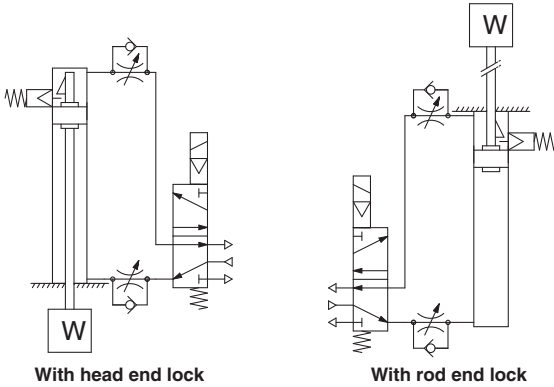

With head end lock

With rod end lock

### Handling

#### ⚠ Caution

- Do not use a 3 position solenoid valve.**  
Avoid using this cylinder in combination with a 3 position solenoid valve (particularly the closed centre metal seal type). If air pressure becomes sealed inside the port on the side that contains the lock mechanism, the lock will not engage. Even if the lock is engaged at first, the air that leaks from the solenoid valve could enter the cylinder and cause the lock to disengage as time elapses.
- Back pressure is necessary for unlocking.**  
Before starting, make sure that air is supplied to the side that is not equipped with a lock mechanism as shown in the diagram above. Otherwise, the lock may not disengage. (Refer to "Rock Disengagement".)
- Disengage the lock before installing or adjusting the cylinder.**  
The lock could become damaged if the cylinder is installed with its lock engaged.
- Operate the cylinder at a load ratio of 50 % or less.**  
The lock might not disengage or might become damaged if a load ratio of 50 % is exceeded.
- Do not synchronize multiple cylinders.**  
Do not operate two or more end lock cylinders synchronised to move a single workpiece because one of the cylinder locks may not be able to disengage when required.
- Operate the speed controller under meter-out control.**  
If operated under meter-in control, the lock might not disengage.
- On the side that has a lock, make sure to operate at the stroke end of the cylinder.**  
The lock might not engage or disengage if the piston of the cylinder has not reached the stroke end.
- Do not use the air cylinder as an air-hydro cylinder. This may result in oil leak.**
- The position adjustment of the auto switch should be performed at two positions; a position determined by the stroke and a position after the backlash movement (by 2 mm).**  
When a 2-colour indication auto switch is adjusted to show green at the stroke end, the indication may turn red when the cylinder returns by the backlash. This, however, is not an error.

### Operating Pressure

#### ⚠ Caution

- Supply air pressure of 0.15 MPa or higher to the port on the side that has the lock mechanism, as it is necessary for disengaging the lock.

### Exhaust Air Speed

#### ⚠ Caution

- The lock will engage automatically if the air pressure at the port on the side that has the lock mechanism becomes 0.05 MPa or less. Be aware that if the piping on the side that has the lock mechanism is narrow and long, or if the speed controller is located far from the cylinder port, the exhaust air speed could become slower, involving a longer time for the lock to engage. A similar result will ensure if the silencer that is installed on the exhaust port of the solenoid valve becomes clogged.

### Lock Disengagement

#### ⚠ Warning

- To disengage the lock, make sure to supply air pressure to the port on the side without a lock mechanism, thus preventing the load from being applied to the lock mechanism. (Refer to the recommended air pressure circuit.) If the lock is disengaged when the port on the side that does not contain a lock mechanism is in the exhausted state and the load is being applied to the lock mechanism, undue force will be applied to the lock mechanism, and it may damage the lock mechanism. Also, it could be extremely dangerous, because the piston rod could move suddenly.

### Manual Disengagement

#### ⚠ Caution

##### 1. Non-locking style manual release

Insert the bolt, which is provided as an accessory part, through the rubber cap (it is not necessary to remove the rubber cap). Screw the bolt into the lock piston and pull the bolt to disengage the lock. Releasing the bolt will re-engage the lock.

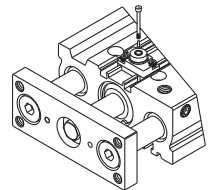

The bolt size, pulling force, and the stroke are listed below.

Bore size [mm]	Thread size	Pulling force	Stroke [mm]
20, 25, 32	M2.5 x 0.45 x 25 L or more	4.9 N	2
40, 50, 63	M3 x 0.5 x 30 L or more	10 N	3
80, 100	M5 x 0.8 x 40 L or more	24.5 N	3

Bolt should be detached under normal operation, otherwise it may cause malfunction of the locking feature.

##### 2. Locking style manual release

Turn 90° counterclockwise while pushing the M/O knob. Lock is released when ▲ on the cap and ▼ OFF mark on the M/O knob correspond. (Lock remains released.)

When locking is desired, turn 90° clockwise while fully pushing the M/O knob and correspond ▲ on the cap and ▼ ON mark on the M/O knob. Confirm the correct position by click sound "click". Otherwise, lock may not be engaged.

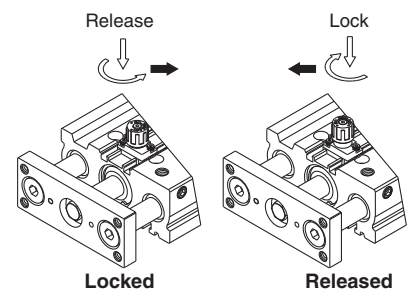

Basic Type  
MGP-Z

With Air Cushion  
MGP-AZ

With End Lock  
MGP

Heavy Duty Guide Rod Type  
MGPS

Auto Switch

Made to Order

# Compact Guide Cylinder/ Heavy Duty Guide Rod Type

## Series **MGPS**

∅ 50, ∅ 80

### How to Order

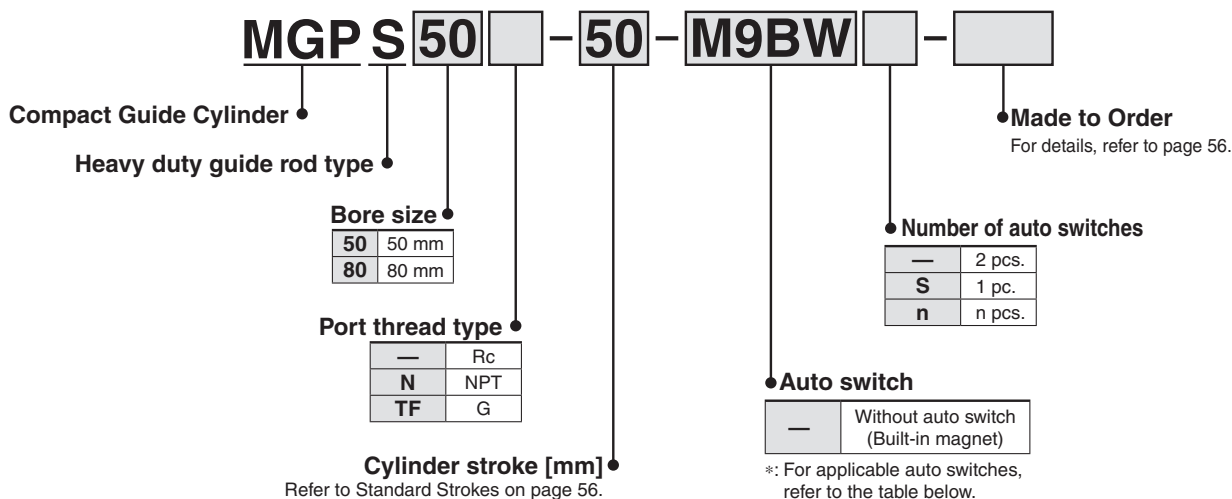

### Applicable Auto Switches/Refer to the **Auto Switch Guide** for further information on auto switches.

Type	Special function	Electrical entry	Indicator light	Wiring (Output)	Load voltage		Auto switch model		Lead wire length [m]				Pre-wired connector	Applicable load			
					DC	AC	Perpendicular	In-line	0.5 (—)	1 (M)	3 (L)	5 (Z)					
Solid state auto switch	—	Grommet	Yes	3-wire (NPN)	24 V	5 V, 12 V	—	M9NV	M9N	●	●	●	○	○	Relay, PLC	IC circuit	
	3-wire (PNP)			M9PV				M9P	●	●	●	○	○				
	2-wire			M9BV				M9B	●	●	●	○	○				
	Diagnostic indication (2-colour indication)			3-wire (NPN)	24 V	5 V, 12 V	—	M9NWV	M9NW	●	●	●	○	○		IC circuit	
				3-wire (PNP)				M9PWV	M9PW	●	●	●	○	○			
	Water resistant (2-colour indication)			2-wire	24 V	12 V	—	M9BWW	M9BW	●	●	●	○	○		—	
				3-wire (NPN)				M9NAV*1	M9NA*1	○	○	●	○	○			
	Magnetic field resistant (2-colour indication)			3-wire (PNP)	24 V	12 V	—	M9PAV*1	M9PA*1	○	○	●	○	○		IC circuit	
				2-wire (Non-polar)				M9BAV*1	M9BA*1	○	○	●	○	○			
	Reed auto switch			—	Grommet	No	3-wire (NPN equivalent)	24 V	12 V	100 V 100 V or less	A96V	A96	●	—		●	—
—		100 V	A93V*2	A93			●				●	●	●	—	—		
		100 V or less	A90V	A90			●				—	●	—			—	—

\*1: Water resistant type auto switches can be mounted on the above models, but in such case SMC cannot guarantee water resistance.

Please consult with SMC regarding water resistant types with the above model numbers.

\*2: 1 m type lead wire is only applicable to the D-A93.

\*: Lead wire length symbols: 0.5 m..... — (Example) M9NW  
 1 m..... M (Example) M9NWM  
 3 m..... L (Example) M9NWL  
 5 m..... Z (Example) M9NWZ

\*: Solid state auto switches marked with "○" are produced upon receipt of order.

\*: Since there are other applicable auto switches than listed above, refer to page 66 for details.

\*: For details about auto switches with pre-wired connector, refer to the **Auto Switch Guide**.

For D-P3DWA□, refer to the **Auto Switch Guide**.

\*: Auto switches are shipped together, (but not assembled).



# Compact Guide Cylinder Heavy Duty Guide Rod Type *Series MGPS*

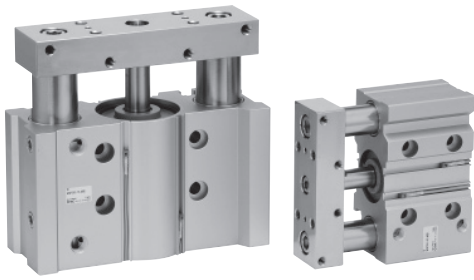

**Symbol**  
Rubber bumper

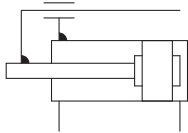

**Made to Order**  
(For details, refer to page 89.)

Symbol	Specifications
-XC85	Grease for food processing equipment
-X867	Side porting type (Plug location changed) *1

\*1: The shape is the same as the current product.

Refer to pages 63 to 67 for cylinders with auto switches.

- Minimum stroke for auto switch mounting
- Auto switch proper mounting position (detection at stroke end) and its mounting height
- Operating range
- Auto switch mounting brackets/Part no.
- Auto switch mounting

## Specifications

Bore size [mm]	50	80
<b>Action</b>	Double acting	
<b>Fluid</b>	Air	
<b>Proof pressure</b>	1.5 MPa	
<b>Maximum operating pressure</b>	1.0 MPa	
<b>Minimum operating pressure</b>	0.1 MPa	
<b>Ambient and fluid temperature</b>	-10 to 60 °C (No freezing)	
<b>Piston speed *1</b>	50 to 400 mm/s	
<b>Cushion</b>	Rubber bumper on both ends	
<b>Lubrication</b>	Not required (Non-lube)	
<b>Stroke length tolerance</b>	+1.5 0 mm	

\*1: Maximum speed with no load. Depending on the operating conditions, the piston speed may not be satisfied. Make a model selection, considering a load according to the graph on pages 57 to 59.

## Standard Strokes

Bore size [mm]	Standard stroke [mm]
50, 80	25, 50, 75, 100, 125, 150, 175, 200

## Manufacture of Intermediate Stroke

<b>Description</b>	Spacer installation type Spacers are installed in the standard stroke cylinder. Available in 5 mm stroke increments.
<b>Part no.</b>	Refer to "How to Order" for the standard model numbers on page 55.
<b>Applicable stroke [mm]</b>	5 to 195
<b>Example</b>	Part no.: MGPS50-35 A spacer 15 mm in width is installed in a MGPS50-50. C dimension is 94 mm.

\*: Intermediate stroke (in 1 mm increments) based on an exclusive body will be available upon request for special.

## Theoretical Output

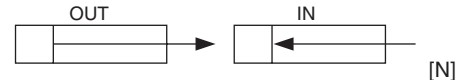

Bore size [mm]	Rod size [mm]	Operating direction	Piston area [mm <sup>2</sup> ]	Operating pressure [MPa]								
				0.2	0.3	0.4	0.5	0.6	0.7	0.8	0.9	1.0
50	20	OUT	1963	393	589	785	982	1178	1374	1571	1767	1963
		IN	1649	330	495	660	825	990	1155	1319	1484	1649
80	25	OUT	5027	1005	1508	2011	2513	3016	3519	4021	4524	5027
		IN	4536	907	1361	1814	2268	2721	3175	3629	4082	4536

\*: Theoretical output [N] = Pressure [MPa] x Piston area [mm<sup>2</sup>]

## Weights

Bore size [mm]	Standard stroke [mm]							
	25	50	75	100	125	150	175	200
50	3.90	4.68	5.74	6.52	7.30	8.08	8.86	9.64
80	9.21	10.7	13.0	14.5	15.9	17.9	18.9	20.3

## Allowable Rotational Torque of Plate

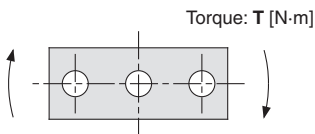

Bore size [mm]	Standard stroke [mm]							
	25	50	75	100	125	150	175	200
50	15	12	16	15	13	12	11	9.8
80	49	41	51	45	41	38	35	32

## Non-rotating Accuracy of Plate

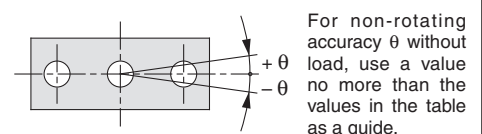

Bore size [mm]	Non-rotating accuracy $\theta$
50	$\pm 0.05^\circ$
80	$\pm 0.04^\circ$

Basic Type **MGPS-Z**  
With Air Cushion **MGPS-AZ**  
With End Lock **MGPS**  
Heavy Duty Guide Rod Type **MGPS**  
Auto Switch  
Made to Order

# Series MGPS Model Selection

## Selection Conditions

Mounting orientation	Vertical		Horizontal	
Maximum speed [mm/s]	200 or less	400	200 or less	400
Graph (Slide bearing type)	(1), (2)	(3), (4)	(5), (6)	(7), (8)

### Selection Example 1 (Vertical Mounting)

#### Selection conditions

Mounting: Vertical  
Stroke: 50 stroke  
Maximum speed: 200 mm/s  
Work load: 100 kg  
Eccentric distance: 100 mm

Find the point of intersection for the work load of 100 kg and the eccentric distance of 100 mm on graph 1, based on vertical mounting, 50 mm stroke, and the speed of 200 mm/s.

→ **MGPS80-50** is selected.

(1) 50 stroke or less,  $V = 200$  mm/s or less

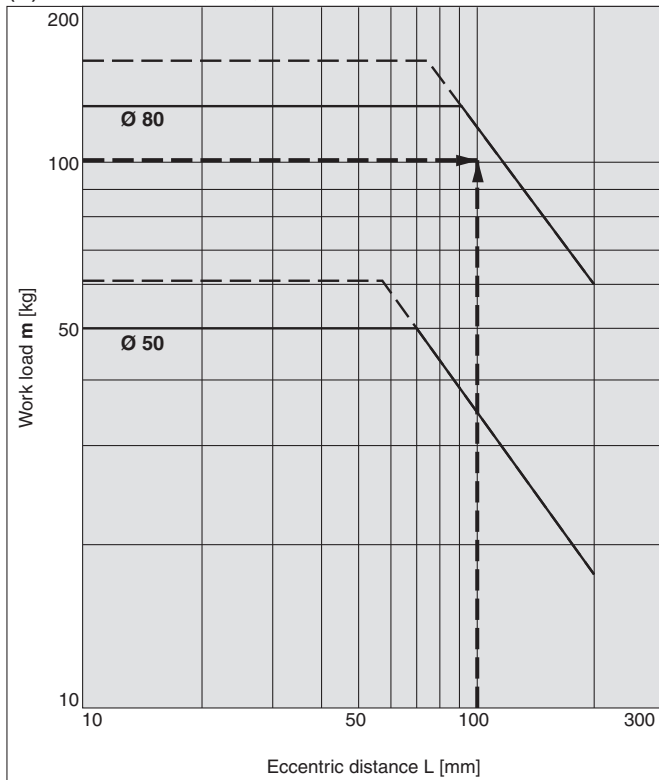

### Selection Example 2 (Horizontal Mounting)

#### Selection conditions

Mounting: Horizontal  
Distance between plate and load centre of gravity: 50 mm  
Maximum speed: 200 mm/s  
Work load: 30 kg  
Stroke: 100 stroke

Find the point of intersection for the work load of 30 kg and 100 stroke on graph 5, based on horizontal mounting, the distance of 50 mm between the plate and load centre of gravity, and the speed of 200 mm/s.

→ **MGPS80-100** is selected.

(5)  $L = 50$  mm,  $V = 200$  mm/s or less

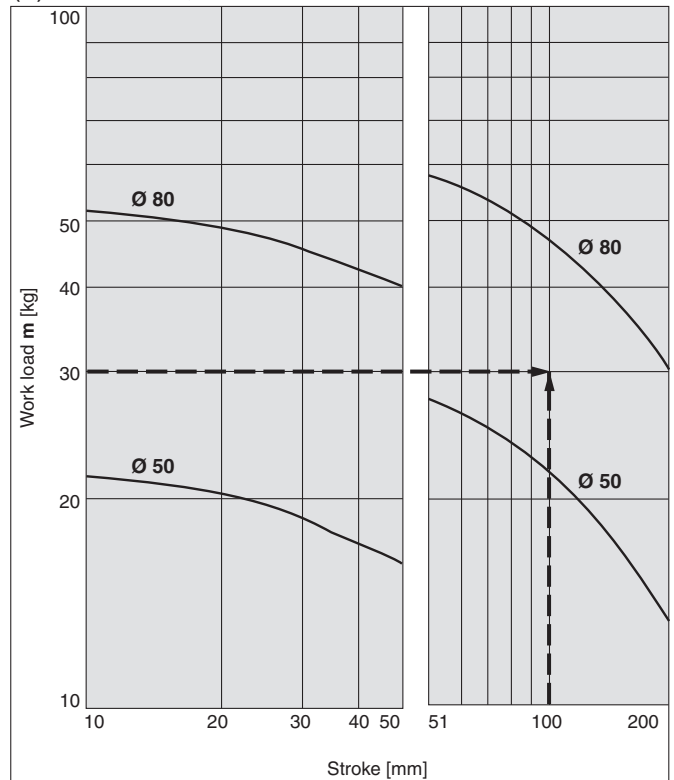

· When the maximum speed exceeds 200 mm/s, the allowable work load is determined by multiplying the value shown in the graph at 400 mm/s by the coefficient listed in the table below.

Maximum	Up to 300 mm/s	Up to 400 mm/s	Up to 500 mm/s
Coefficient	1.7	1	0.6

· Use the Guide Cylinder Selection Software, when the eccentric distance is 200 mm or more.

## Vertical Mounting **Slide Bearing**

— Operating pressure 0.4 MPa  
 - - - - - Operating pressure 0.5 MPa or more

### MGPS50, 80

(1) 50 Stroke or Less, V = 200 mm/s or less

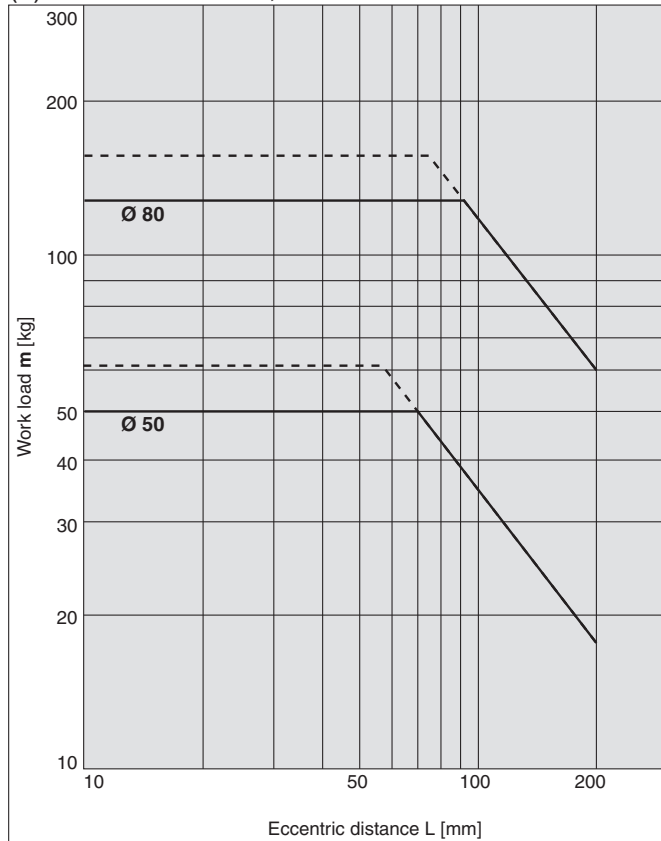

(2) Over 50 Stroke, V = 200 mm/s or less

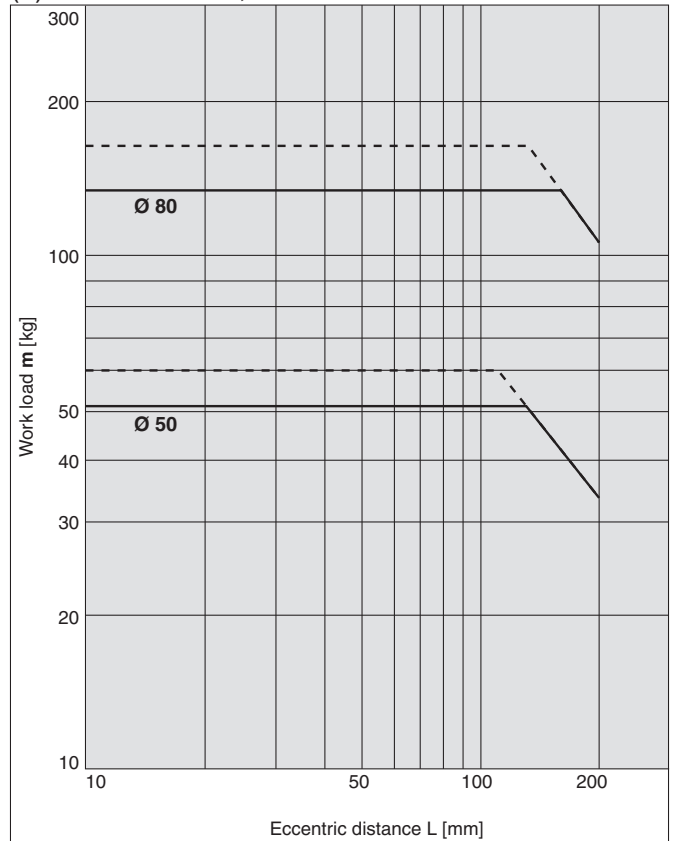

(3) 50 Stroke or Less, V = 400 mm/s

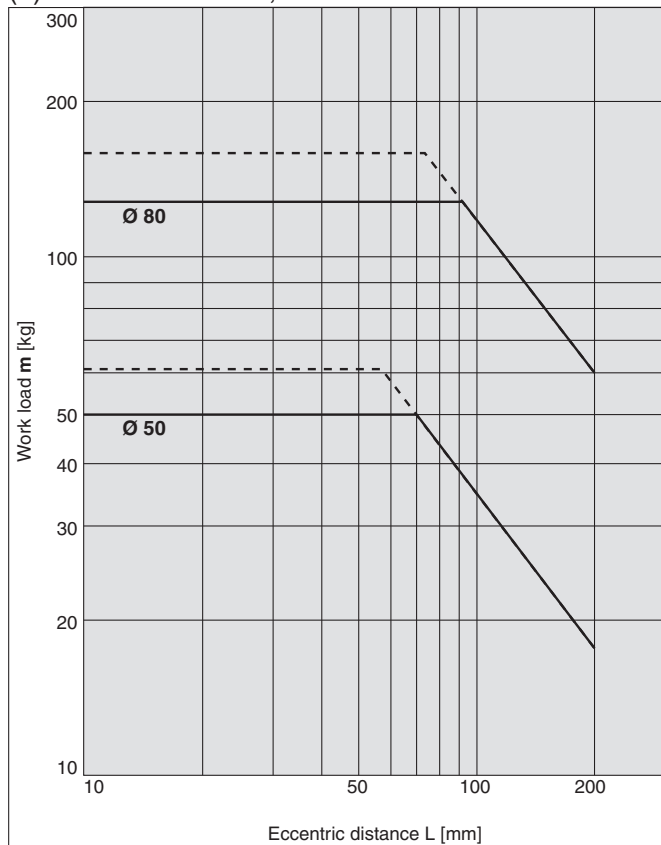

(4) Over 50 Stroke, V = 400 mm/s

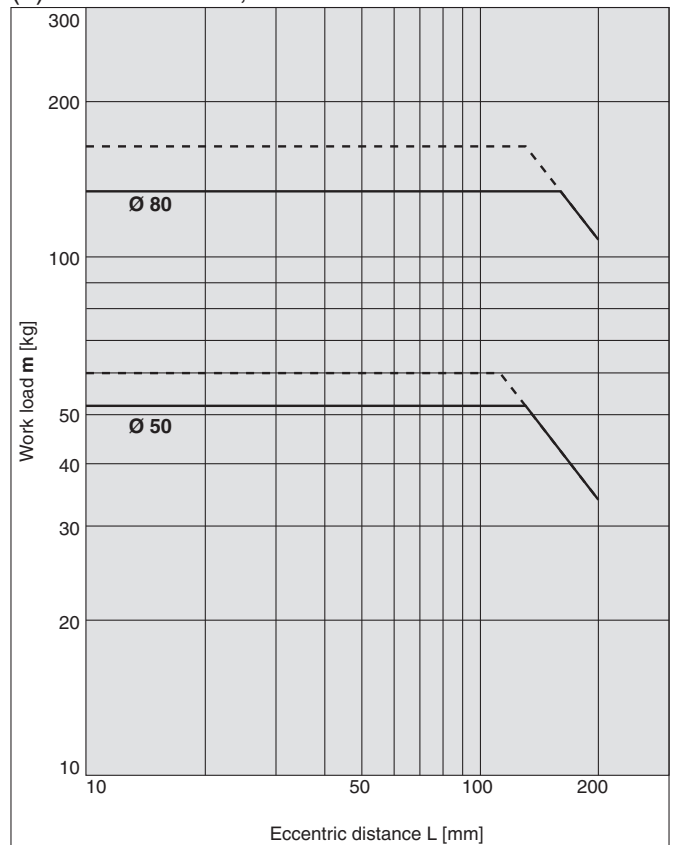

Basic Type  
**MGPS-Z**

With Air Cushion  
**MGPS-AZ**

With End Lock  
**MGPS**

Heavy Duty Guide Rod Type  
**MGPS**

**Auto Switch**

**Made to Order**

· Use the Guide Cylinder Selection Software, when the eccentric distance is 200 mm or more.

# Series MGPS

## Horizontal Mounting Slide Bearing

### MGPS50, 80

(5) L = 50 mm, V = 200 mm/s or less

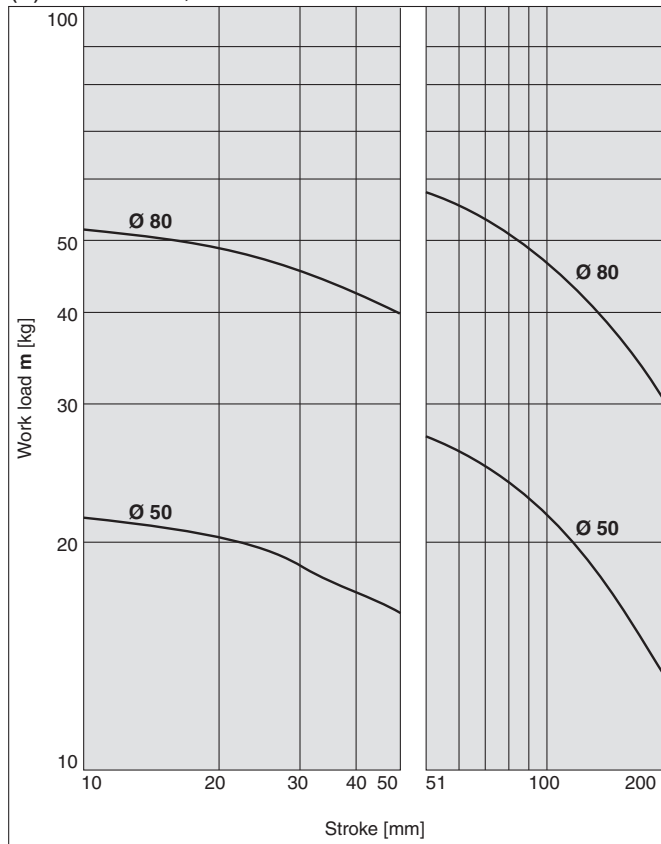

(6) L = 100 mm, V = 200 mm/s or less

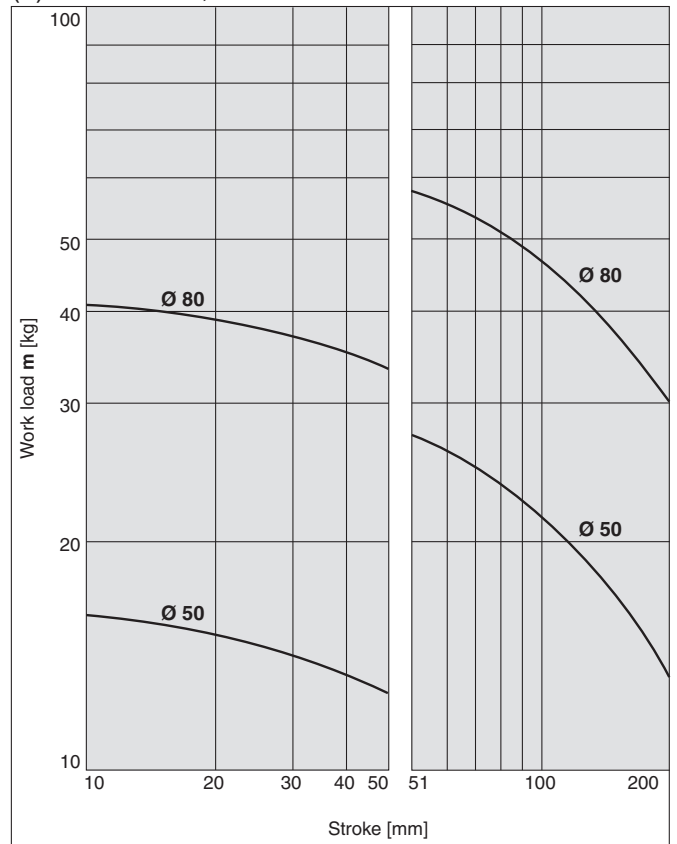

(7) L = 50 mm, V = 400 mm/s

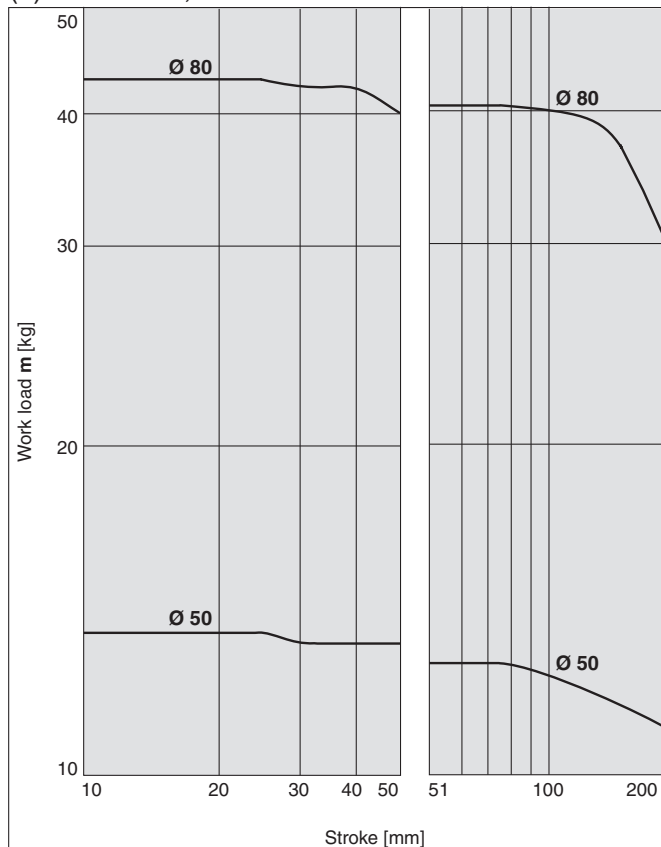

(8) L = 100 mm, V = 400 mm/s

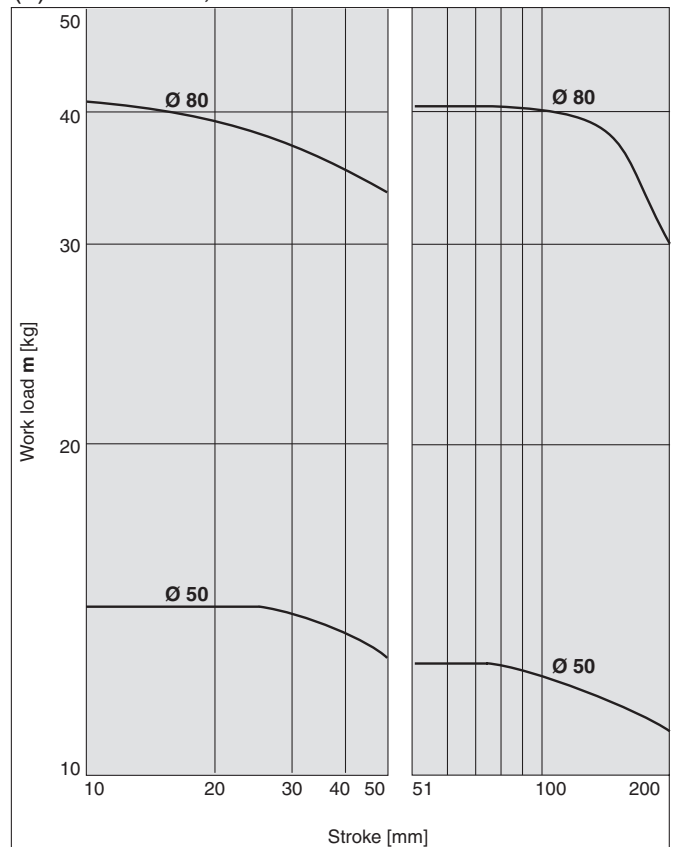

**Operating Range when Used as Stopper**

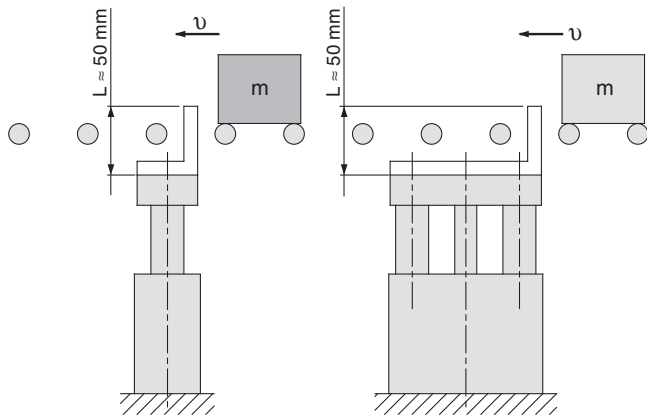

\*: When selecting a model with a longer L dimension, be sure to choose a bore size which is sufficiently large.

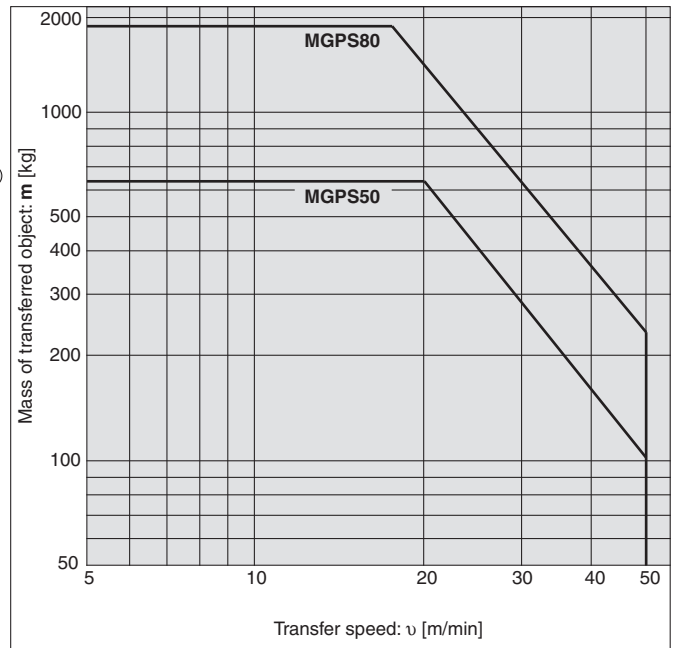

**⚠ Caution**

**Caution on handling**

When using as a stopper, select a model with 50 stroke or less.

Basic Type  
**MGP-Z**

With Air Cushion  
**MGP-AZ**

With End Lock  
**MGP**

Heavy Duty Guide Rod Type  
**MGPS**

**Auto Switch**

**Made to Order**

# Series MGPS

## Construction

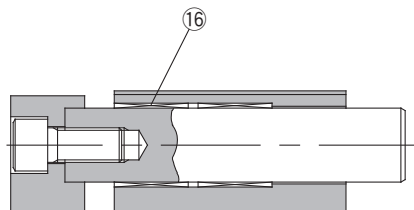

Over 50 stroke

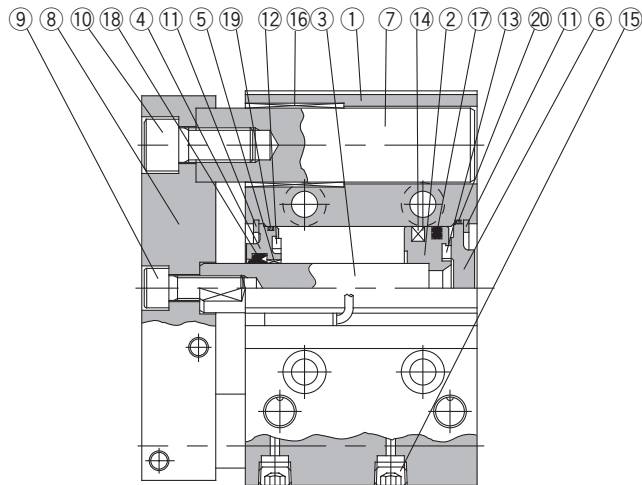

50 stroke or less

### Component Parts

No.	Description	Material	Note
1	<b>Body</b>	Aluminium alloy	Hard anodised
2	<b>Piston</b>	Aluminium alloy	
3	<b>Piston rod</b>	Carbon steel	Hard chrome plating
4	<b>Collar</b>	Aluminium alloy casted	Painted
5	<b>Bushing</b>	Bearing alloy	
6	<b>Head cover</b>	Aluminium alloy	Ø 50 Chromated
			Ø 80 Painted
7	<b>Guide rod</b>	Carbon steel	Hard chrome plating
8	<b>Plate</b>	Carbon steel	Nickel plating
9	<b>Plate mounting bolt A</b>	Carbon steel	Nickel plating For piston rod
10	<b>Plate mounting bolt B</b>	Carbon steel	Nickel plating For guide rod

### Component Parts

No.	Description	Material	Note
11	<b>Retaining ring</b>	Carbon tool steel	Phosphate coated
12	<b>Bumper A</b>	Urethane	
13	<b>Bumper B</b>	Urethane	
14	<b>Magnet</b>	—	
15	Hexagon socket head taper plug	Carbon steel	Nickel plating
16	<b>Slide Bearing</b>	Bearing alloy	
17*	<b>Piston seal</b>	NBR	
18*	<b>Rod seal</b>	NBR	
19*	<b>Gasket A</b>	NBR	
20*	<b>Gasket B</b>	NBR	

### Replacement Parts/Seal Kit

Bore size [mm]	Kit no.	Contents
50	MGP50-PS	Set of nos. above 17, 18, 19, 20
80	MGP80-PS	

\*: Seal kit includes 17 to 20. Order the seal kit, based on each bore size.

\*: Since the seal kit does not include a grease pack, order it separately.

**Grease pack part no.: GR-S-010 (10 g)**

# Compact Guide Cylinder Heavy Duty Guide Rod Type *Series MGPS*

## Dimensions

### MGPS50, 80

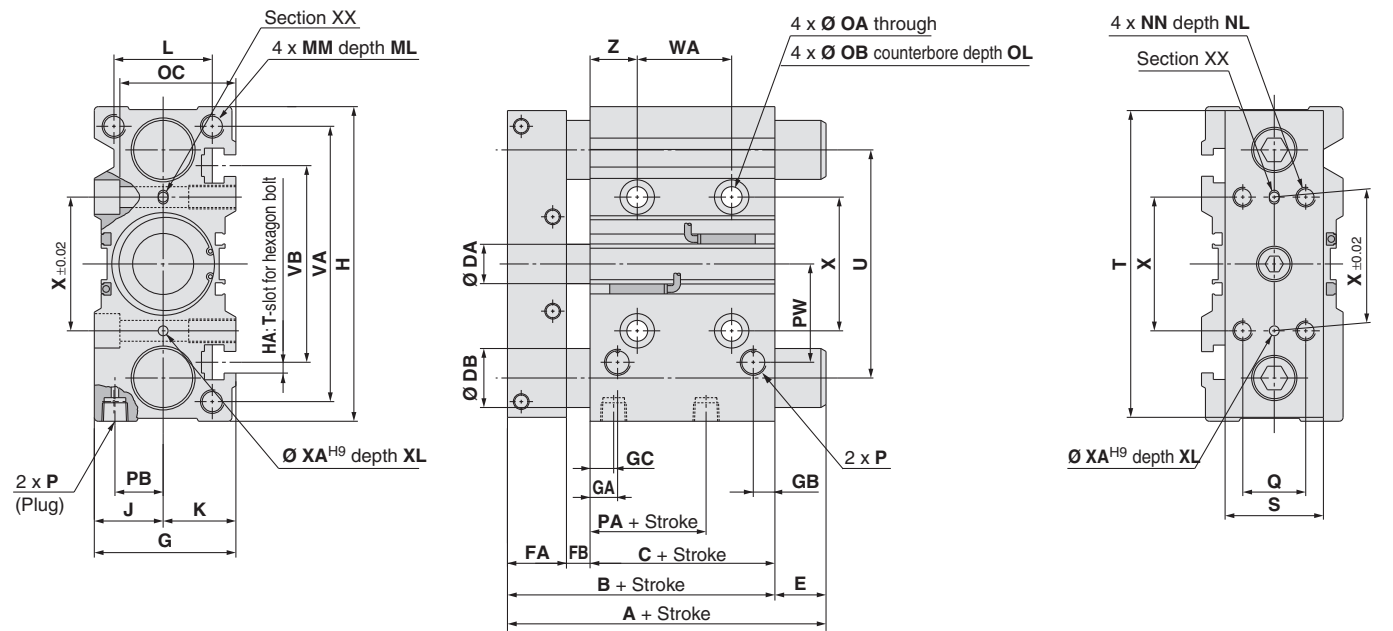
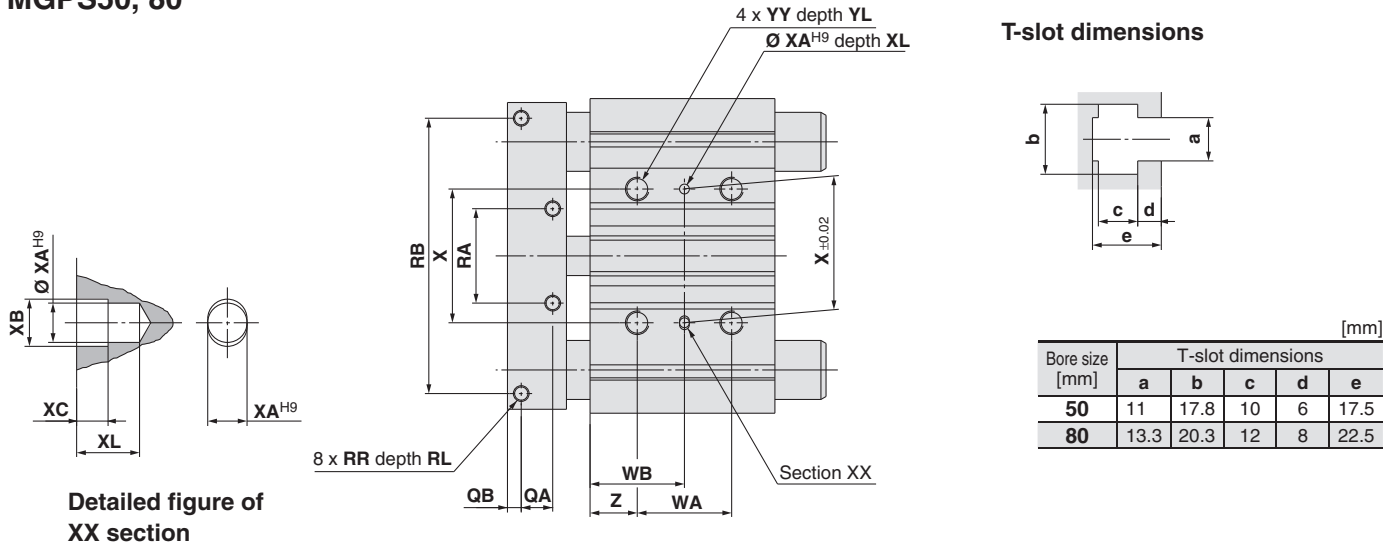

\*: For intermediate strokes other than standard strokes, refer to the Manufacture of Intermediate Stroke on page 56.  
\*: Rc, NPT and G ports can be selected. (Refer to page 55.)

## Dimensions

Bore size [mm]	Standard stroke [mm]	A		B	C	DA	DB	E		FA	FB	G	GA	GB	GC	H	HA	J	K	L
		25, 50 st	Over 50 st					25, 50 st	Over 50 st											
50	25, 50, 75, 100	86	110	86	44	20	30	0	24	30	12	72	14	11	12	160	M10	35	37	50
80	125, 150, 175, 200	118	151	118	65	25	45	0	33	35	18	95	19	24	14.5	242	M12	47	48	66

Bore size [mm]	MM	ML	NN	NL	OA	OB	OC	OL	P			PA	PB	PW	Q	QA	QB	RA	RB	RR
									—	N	TF									
50	M12 x 1.75	20	M10 x 1.5	20	10.6	17.5	59	13	Rc 1/4	NPT 1/4	G 1/4	9	24.5	50	32	16	7	48	140	M8 x 1.25
80	M16 x 2.0	32	M12 x 1.75	24	12.5	20	72	17.5	Rc 3/8	NPT 3/8	G 3/8	14.5	29	77	40	18	9	80	200	M10 x 1.5

Bore size [mm]	RL	S	T	U	VA	VB	WA			WB			X	XA	XB	XC	XL	YY	YL	Z
							25 st	50, 75, 100 st	Over 100 st	25 st	50, 75, 100 st	Over 100 st								
50	14	50	156	116	140	100	24	48	124	36	48	86	68	5	6	4	8	M12 x 1.75	24	24
80	20	65	228	170	214	138	28	52	128	42	54	92	100	6	7	5	10	M14 x 2.0	28	28

Basic Type  
**MGP-Z**

With Air Cushion  
**MGP-AZ**

With End Lock  
**MGP**

Heavy Duty Guide Rod Type  
**MGPS**

Auto Switch

Made to Order

# Series MGP

## Auto Switch Mounting

Auto Switch Proper Mounting Position (Detection at stroke end) and Its Mounting Height/MGP-Z (Basic type), MGP-AZ (Air cushion), MGPS (Heavy duty guide rod type)

D-M9□/M9□V  
 D-M9□W/M9□WV  
 D-M9□A/M9□AV  
 D-A9□/A9□V

∅ 12 to ∅ 100

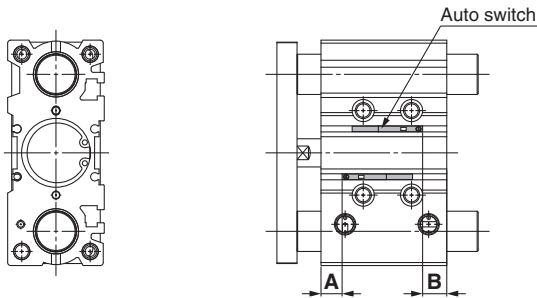

D-P3DWA

∅ 25 to ∅ 63

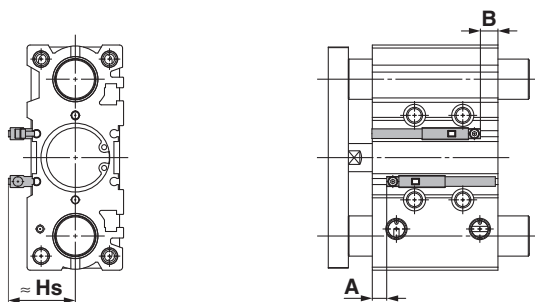

∅ 80, ∅ 100

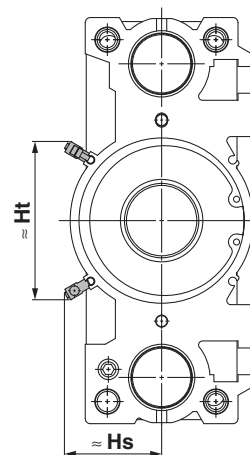

D-P4DW

∅ 32 to ∅ 63

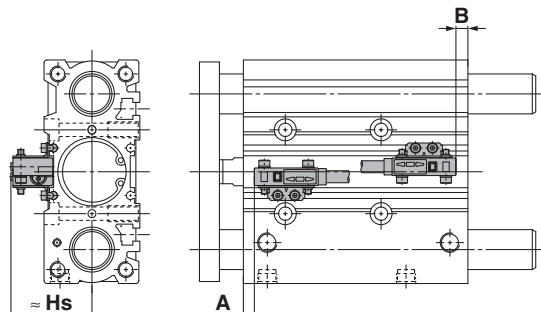

∅ 80, ∅ 100

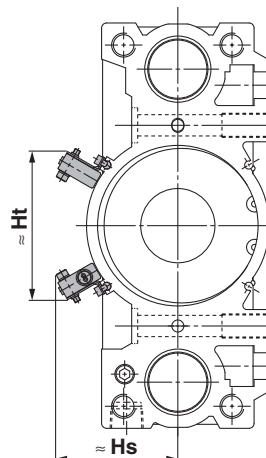

※: The MGP-Z (Basic type) is shown as a representative example.



## Applicable Cylinder: MGP-Z (Basic type) Auto Switch Proper Mounting Position [mm]

Auto switch model \ Bore size	D-M9□ D-M9□V D-M9□W D-M9□WV D-M9□A D-M9□AV		D-A9□ D-A9□V		D-P3DWA		D-P4DW <sup>*1</sup>	
	A	B	A	B	A	B	A	B
12	7.5	9.5	3.5	5.5	—	—	—	—
16	10.5	10.5	6.5	6.5	—	—	—	—
20	12.5	12.5	8.5	8.5	—	—	—	—
25	11.5	14	7.5	10	7	9.5	—	—
32	12.5	13	8.5	9	8	8.5	5.5	6
40	15.5	16.5	11.5	12.5	11	12	8.5	9.5
50	14.5	17	10.5	13	10	12.5	7.5	10
63	16.5	20	12.5	16	12	15.5	9.5	13
80	18	26	14	22	13.5	21.5	11	19
100	21.5	32.5	17.5	28.5	17	28	14.5	25.5

\*1: The auto switch mounting bracket BMG7-032 is used.  
\*: Adjust the auto switch after confirming the operating conditions in the actual setting.

## Applicable Cylinder: MGP-Z (Basic type) Auto Switch Proper Mounting Height [mm]

Auto switch model \ Bore size	D-M9□V D-M9□WV D-M9□AV		D-A9□V		D-P3DWA		D-P4DW <sup>*1</sup>	
	Hs	Ht	Hs	Ht	Hs	Ht	Hs	Ht
12	19.5	—	17	—	—	—	—	—
16	22	—	19.5	—	—	—	—	—
20	24.5	—	22	—	—	—	—	—
25	26	—	24	—	32.5	—	—	—
32	29	—	26.5	—	35	—	40	—
40	33	—	30.5	—	39	—	44	—
50	38.5	—	36	—	44.5	—	49.5	—
63	45.5	—	43	—	51.5	—	56.5	—
80	45	74	43	71.5	50	80.5	61	74
100	55	85.5	53	83	60	92	71.5	86

\*1: The auto switch mounting bracket BMG7-032 is used.

## Applicable Cylinder: MGP-AZ (Air cushion) Auto Switch Proper Mounting Position [mm]

Auto switch model \ Bore size	D-M9□ D-M9□V D-M9□W D-M9□WV D-M9□A D-M9□AV		D-A9□ D-A9□V		D-P3DWA		D-P4DW <sup>*1</sup>	
	A	B	A	B	A	B	A	B
16	25	20.5	21	16.5	—	—	—	—
20	27	23	23	19	—	—	—	—
25	27	23	23	19	22.5	18.5	—	—
32	21	29	17	25	16.5	24.5	14	22
40	25.5	31.5	21.5	27.5	21	27	18.5	24.5
50	26	30.5	22	26.5	21.5	26	19	23.5
63	30	31.5	26	27.5	25.5	27	23	24.5
80	30.5	38.5	26.5	34.5	26	34	23.5	31.5
100	34.5	44	30.5	40	30	39.5	27.5	37

\*1: The auto switch mounting bracket BMG7-032 is used.

## Applicable Cylinder: MGP-AZ (Air cushion) Auto Switch Proper Mounting Height [mm]

Auto switch model \ Bore size	D-M9□V D-M9□WV D-M9□AV		D-A9□V		D-P3DWA		D-P4DW <sup>*1</sup>	
	Hs	Ht	Hs	Ht	Hs	Ht	Hs	Ht
16	22	—	19.5	—	—	—	—	—
20	24.5	—	22	—	—	—	—	—
25	26	—	24	—	32.5	—	—	—
32	29	—	26.5	—	35	—	40	—
40	33	—	30.5	—	39	—	44	—
50	38.5	—	36	—	44.5	—	49.5	—
63	45.5	—	43	—	51.5	—	56.5	—
80	45	74	43	71.5	50	80.5	61	74
100	55	85.5	53	83	60	92	71.5	86

\*1: The auto switch mounting bracket BMG7-032 is used.

## Applicable Cylinder: MGPS (Heavy duty guide rod) Auto Switch Proper Mounting Position [mm]

Auto switch model \ Bore size	D-M9□ <sup>*1</sup> D-M9□V D-M9□W D-M9□WV D-M9□A D-M9□AV		D-A9□ <sup>*1</sup> D-A9□V		D-Z7□ D-Z80 D-Y59□ D-Y7P D-Y69□ D-Y7PV D-Y7□W D-Y7□ D-WV D-Y7BA		D-P3DWA <sup>*1</sup>		D-P4DW <sup>*2</sup>	
	A	B	A	B	A	B	A	B	A	B
50	12.5	16.5	8.5	12.5	7.5	11.5	8	12	7	11
80	18	23.5	14	19.5	13	18.5	13.5	19	12.5	18

\*1: The auto switch mounting bracket BMG2-012 is used.  
\*2: The auto switch mounting bracket BMG 1-040 is used.  
\*: Adjust the auto switch after confirming the operating conditions in the actual setting.

## Applicable Cylinder: MGPS (Heavy duty guide rod) Auto Switch Proper Mounting Height [mm]

Auto switch model \ Bore size	D-M9□ <sup>*1</sup> D-M9□W D-M9□A		D-M9□V <sup>*2</sup> D-M9□WV D-M9□AV		D-A9□V <sup>*2</sup>		D-Y69□ D-Y7PV D-Y7□WV		D-P3DWA <sup>*2</sup>		D-P4DW <sup>*3</sup>	
	Hs	Hs	Ht	Hs	Ht	Hs	Ht	Hs	Ht	Hs	Ht	
50	32.5	38.5	—	36	—	34	—	44.5	—	50	—	
80	40	45	74	43	71.5	41	70	49.5	78.5	61	84.5	

\*1: For the D-M9□, the auto switch mounting bracket BMG2-012 is used.  
\*2: The auto switch mounting bracket BMG2-012 is used.  
\*3: The auto switch mounting bracket BMG 1-040 is used.

Basic Type  
**MGP-Z**

With Air Cushion  
**MGP-AZ**

With End Lock  
**MGP**

Heavy Duty Guide Rod Type  
**MGPS**

Auto Switch

Made to Order

# Series MGP

## Auto Switch Proper Mounting Position (Detection at stroke end) and Its Mounting Height/MGP (With end lock)

Applicable cylinder: Series MGP, With end lock

With rod end lock

D-M9□	D-M9□A	D-Z7□	D-Y7P
D-M9□V	D-M9□AV	D-Z80	D-Y7PV
D-M9□W	D-A9□	D-Y59□	D-Y7□W
D-M9□WV	D-A9□V	D-Y69□	D-Y7□WV
			D-Y7BA

### Auto Switch Proper Mounting Position [mm]

Bore size	D-M9□ <sup>*1</sup>		D-A9□ <sup>*1</sup>		D-Z7□/Z80 D-Y59□/Y7P D-Y69□/Y7PV D-Y7□W D-Y7□WV D-Y7BA		D-P3DWA <sup>*3, *4</sup>		D-P4DW <sup>*2</sup>	
	A	B	A	B	A	B	A	B	A	B
	20	40	7	36	3	35	2	—	—	—
25	40.5	7	36.5	3	35.5	2	36	2.5 <sup>*5</sup>	—	—
32	37.5	10	33.5	6	32.5	5	33	6	32	4.5
40	43.5	10.5	39.5	6.5	38.5	5.5	39	6	38	5
50	44.5	9.5	40.5	5.5	39.5	4.5	40	5	39	4
63	47	12	43	8	42	7	42.5	7.5	41.5	6.5
80	68	23.5	64	19.5	63	18.5	63.5	19	62.5	18
100	72.5	28.5	68.5	24.5	67.5	23.5	68	24	67	23

- \*1: The auto switch mounting bracket BMG2-012 is used.
- \*2: The auto switch mounting bracket BMG 1-040 is used.
- \*3: The auto switch mounting bracket BMG10-025 is used.
- \*4: This shows the top end position of the mounting bracket when the auto switch is put in contact with the mounting bracket.
- \*5: When mounted on the head end of  $\varnothing 25$ , the tip of the BMG2-012 protrudes 3.5 mm from the cylinder body.
- \*: Adjust the auto switch after confirming the operating conditions in the actual setting.

### Auto Switch Proper Mounting Height (D-P3DWA) [mm]

Bore size	Hs	Ht
25	32	—
32	35	—
40	39	—
50	44.5	—
63	51.5	—
80	49.5	78.5
100	60	90

### Auto Switch Proper Mounting Height (D-P4DW) [mm]

Bore size	Hs	Ht
32	41.5	—
40	44.5	—
50	50	—
63	57	—
80	61	84.5
100	71	96.5

With head end lock

D-M9□	D-M9□A	D-Z7□	D-Y7P
D-M9□V	D-M9□AV	D-Z80	D-Y7PV
D-M9□W	D-A9□	D-Y59□	D-Y7□W
D-M9□WV	D-A9□V	D-Y69□	D-Y7□WV
			D-Y7BA

### Auto Switch Proper Mounting Position [mm]

Bore size	D-M9□ <sup>*1</sup>		D-A9□ <sup>*1</sup>		D-Z7□/Z80 D-Y59□/Y7P D-Y69□/Y7PV D-Y7□W D-Y7□WV D-Y7BA		D-P3DWA <sup>*3, *4</sup>		D-P4DW <sup>*2</sup>	
	A	B	A	B	A	B	A	B	A	B
	20	9	38	5	34	4	33	—	—	—
25	9.5	38	5.5	34	4.5	33	6	33.5	—	—
32	10.5	37	6.5	33	5.5	32	6	32.5	5	31.5
40	14.5	39.5	10.5	35.5	9.5	34.5	10	35	9	34
50	12.5	41.5	8.5	37.5	7.5	36.5	8	37	7	36
63	15	44	11	40	10	39	10.5	39.5	9.5	38.5
80	18	73.5	14	69.5	13	68.5	13.5	69	12.5	68
100	22.5	78.5	18.5	74.5	17.5	73.5	18	74	17	73

- \*1: The auto switch mounting bracket BMG2-012 is used.
- \*2: The auto switch mounting bracket BMG 1-040 is used.
- \*3: The auto switch mounting bracket BMG10-025 is used.
- \*4: This shows the top end position of the mounting bracket when the auto switch is put in contact with the mounting bracket.
- \*: Adjust the auto switch after confirming the operating conditions in the actual setting.

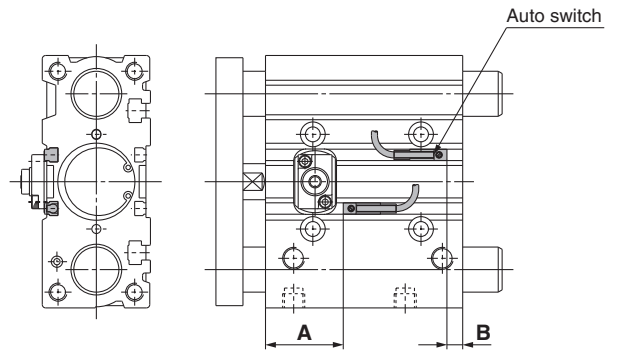

For D-P3DWA (\*: Cannot be mounted on bore size  $\varnothing 20$ .)

$\varnothing 25$  to  $\varnothing 63$

$\varnothing 80, \varnothing 100$

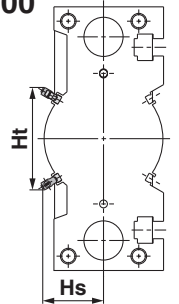
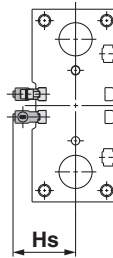

For D-P4DW (\*: Cannot be mounted on bore size  $\varnothing 25$  or less.)

$\varnothing 32$  to  $\varnothing 63$

$\varnothing 80, \varnothing 100$

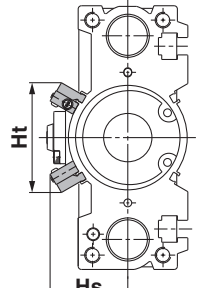
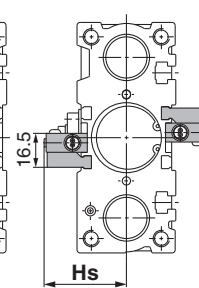
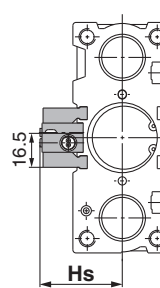

For 25 stroke

- \*: For bore sizes  $\varnothing 40$  to  $\varnothing 63$  with two auto switches, one switch is mounted on each side.

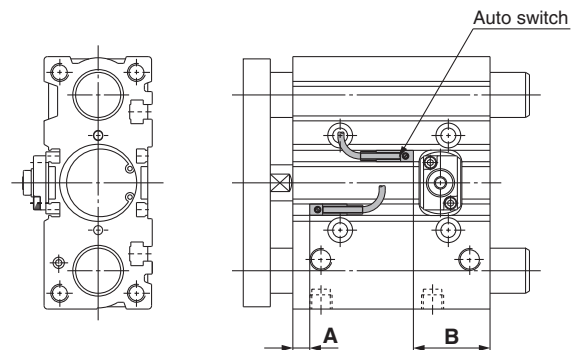

### Mounting of Auto Switch

## ⚠ Caution

In the case of 2.5 st or less with head side end lock type, it might not insert auto switch from the rod side. In this case, install it after removing the plate temporarily. Regarding the plate removal and the way of assembly, please consult with SMC.

## Minimum Stroke for Auto Switch Mounting

		[mm]										
Auto switch model	Number of auto switches	Ø 12	Ø 16	Ø 20	Ø 25	Ø 32	Ø 40	Ø 50	Ø 63	Ø 80	Ø 100	
D-M9□V	1 pc.						5					
	2 pcs.						5					
D-M9□	1 pc.	5 *1						5				
	2 pcs.	10 *1				10						
D-M9□W	1 pc.						5 *2					
	2 pcs.	10 *2				10						
D-M9□WV D-M9□AV	1 pc.						5 *2					
	2 pcs.						10					
D-M9□A	1 pc.						5 *2					
	2 pcs.						10 *2					
D-A9□	1 pc.	—		5 *1			5					
	2 pcs.	—		10 *1			10					
D-A9□V	1 pc.						5					
	2 pcs.						10					
D-Z7□ D-Z80	1 pc.	—		5 *1			5					
	2 pcs.	—					10					
D-Y59□ D-Y7P	1 pc.	—		5 *1			5					
	2 pcs.	—					10					
D-Y69□ D-Y7PV	1 pc.	—					5					
	2 pcs.	—					5					
D-Y7□W D-Y7□WV	1 pc.	—					5 *2					
	2 pcs.	—					10 *2					
D-Y7BA	1 pc.	—					5 *2					
	2 pcs.	—					10 *2					
D-P3DWA	1 pc.	—					15 *2					
	2 pcs.	—					15 *2					
D-P4DW	1 pc.	—					5 *2					
	2 pcs. (Different surfaces)	—					10 *2					
	2 pcs. (Same surface)	—					75				10	

\*1: Confirm that it is possible to secure the minimum bending radius of 10 mm of the auto switch lead wire before use.

\*2: Confirm that it is possible to securely set the auto switch(es) within the range of indicator green light ON range before use.

For in-line entry type, also consider \*1 shown above.

## Operating Range

Auto switch model	Bore size [mm]									
	12	16	20	25	32	40	50	63	80	100
D-M9□/M9□V D-M9□W/M9□WV D-M9□A/M9□AV	3.5	5	5	5	6	6	6	6.5	6	7
D-A9□/A9□V	7	9	9	9	9.5	9.5	9.5	11	10.5	10.5
D-Z7□/Z80	—	—	10	10	10.5	10.5	10.5	11.5	11.5	12
D-Y59□/Y69□ D-Y7P/Y7PV D-Y7□W/Y7□WV D-Y7BA	—	—	7.5	7	6.5	6	7	8	9.5	10
D-P3DWA	—	—	—	5.5	6.5	6	6	6.5	6	7
D-P4DW	—	—	—	—	5	4	4	5	4	4

\*: Values which include hysteresis are for guideline purposes only, they are not a guarantee (assuming approximately ±30 % dispersion) and may change substantially depending on the ambient environment.

**Other than the applicable auto switches listed in How to Order, the following auto switches are mountable.**

Refer to the **Auto Switch Guide** for the detailed specifications.

Type	Model	Electrical entry	Features
Reed	D-Z73, Z76	Grommet (In-line)	—
	D-Z80		Without indicator light
Solid state	D-P4DW	Grommet (In-line)	Magnetic field resistant (2-colour indication) Bore size: Ø 32 to Ø 100
	D-Y69A, Y69B, Y7PV	Grommet (Perpendicular)	—
	D-Y7NWW, Y7PWV, Y7BWV		Diagnostic indication (2-colour indication)
	D-Y59A, Y59B, Y7P	Grommet (In-line)	—
	D-Y7NW, Y7PW, Y7BW		Diagnostic indication (2-colour indication)
	D-Y7BA		Water resistant (2-colour indication)

\*: With pre-wired connector is also available for solid state auto switches.

For details, refer to the **Auto Switch Guide**.

\*: Normally closed (NC = b contact) solid state auto switches (D-F9G/F9H) are also available.

For details, refer to the **Auto Switch Guide**.

\*: When installing the D-P4DW, use the BMG7-032 auto switch mounting bracket.

Basic Type  
**MGP-Z**

With Air Cushion  
**MGP-AZ**

With End Lock  
**MGP**

Heavy Duty Guide Rod Type  
**MGPS**

Auto Switch

Made to Order

## Auto Switch Mounting

Applicable Cylinder: MGP-Z (Basic type), MGP-AZ (Air cushion)

Applicable auto switches	D-M9□/M9□V D-M9□W/M9□WV D-M9□A/M9□AV D-A9□/A9□V	D-P3DWA						
Bore size [mm]	Ø 12 to Ø 100	Ø 25 to Ø 100						
Auto switch tightening torque	[N·m] <table border="1"> <thead> <tr> <th>Auto switch model</th> <th>Tightening torque</th> </tr> </thead> <tbody> <tr> <td>D-M9□(V) D-M9□W(V) D-M9□A(V)</td> <td>0.05 to 0.15</td> </tr> <tr> <td>D-A9□(V)</td> <td>0.10 to 0.20</td> </tr> </tbody> </table>	Auto switch model	Tightening torque	D-M9□(V) D-M9□W(V) D-M9□A(V)	0.05 to 0.15	D-A9□(V)	0.10 to 0.20	0.2 to 0.3 N·m
Auto switch model	Tightening torque							
D-M9□(V) D-M9□W(V) D-M9□A(V)	0.05 to 0.15							
D-A9□(V)	0.10 to 0.20							

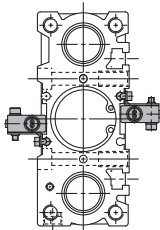
Applicable auto switches	D-P4DW
Bore size [mm]	Ø 32 to Ø 100
Auto switch mounting bracket part no.	BMG7-032
Auto switch mounting bracket/ Quantity	<ul style="list-style-type: none"> <li>• Auto switch mounting bracket x 1 pc.</li> <li>• Auto switch mounting nut x 1 pc.</li> <li>• Hexagon socket head cap screw x 2 pcs.</li> <li>• Hexagon socket head cap screw x 2 pcs. (With spring washer x 2 pcs.)</li> </ul>
Auto switch mounting surface	

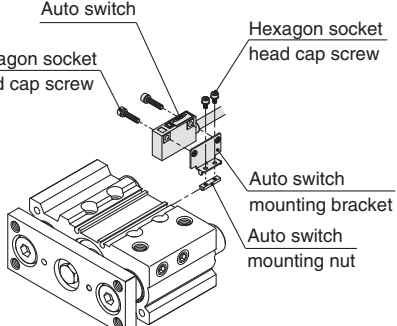
Mounting of auto switch	<ol style="list-style-type: none"> <li>1. Attach the auto switch to the auto switch mounting bracket with the hexagon socket head cap screw (M 3 x 1.4 L). The tightening torque for the M 3 hexagon socket head cap screw is 0.5 to 0.8 N·m.</li> <li>2. Fix the auto switch mounting nut and the auto switch mounting bracket temporarily by tightening the hexagon socket head cap screw (M2.5 x 5 L).</li> <li>3. Insert the temporarily fixed auto switch mounting bracket into the auto switch mounting groove, and slide the auto switch through the auto switch mounting groove.</li> <li>4. Check the detecting position of the auto switch and fix the auto switch firmly with the hexagon socket head cap screw (M 2.5 x 5 L). The tightening torque for the M 2.5 hexagon socket head cap screw is 0.2 to 0.3 N·m.</li> <li>5. If the detecting position is changed, go back to step 3.</li> </ol> 
-------------------------	--

Applicable Cylinder: MGP (With end lock), MGPS (Heavy duty guide rod type)

Auto switch model	Bore size [mm]	
	Ø 25	Ø 32 to Ø 100
D-M9□/M9□V D-M9□W/M9□WV D-M9□A/M9□AV D-A9□/A9□V	BMG2-012	
D-P3DWA	BMG10-025 (With end lock) BMG2-012 (Heavy duty guide rod type)	
D-P4DW	—	BMG 1-040

\*: Cylinders with an end lock are available in Ø 20 to Ø 100.  
\*: The heavy duty guide rod type is available in Ø 50 and Ø 80.

· For D-A9□(V)/M9□(V)/M9□W(V)/M9□A(V)

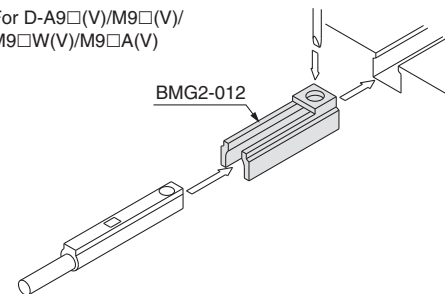

\*: Auto switch mounting brackets and auto switches are enclosed with the cylinder for shipment. For an environment that needs the water-resistant auto switch, select the D-M9□A(V) type.

# Prior to Use

## Auto Switch Connection and Example

### Sink Input Specifications

#### 3-wire, NPN

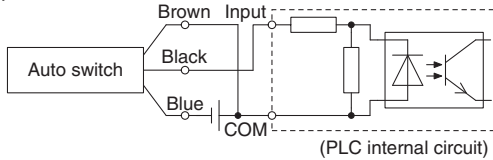

#### 2-wire

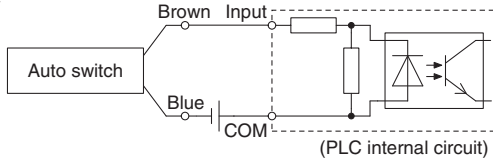

### Source Input Specifications

#### 3-wire, PNP

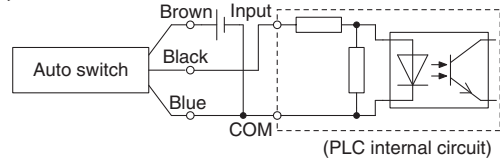

#### 2-wire

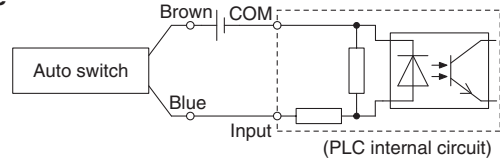

Connect according to the applicable PLC input specifications, as the connection method will vary depending on the PLC input specifications.

### Example of AND (Series) and OR (Parallel) Connection

\*: When using solid state auto switches, ensure the application is set up so the signals for the first 50 ms are invalid.

#### 3-wire AND connection for NPN output (Using relays)

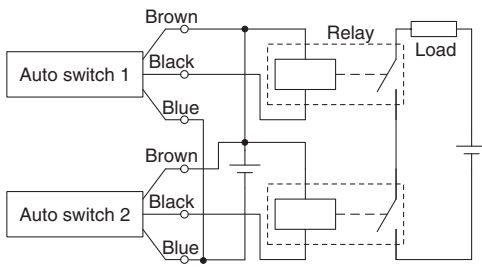

#### (Performed with auto switches only)

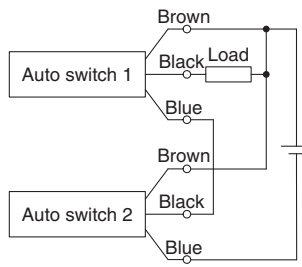

#### 3-wire OR connection for NPN output

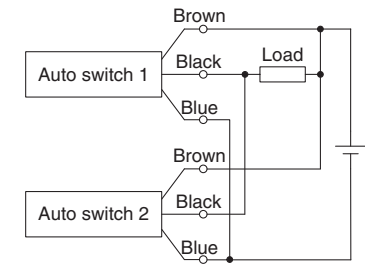

#### 3-wire AND connection for PNP output (Using relays)

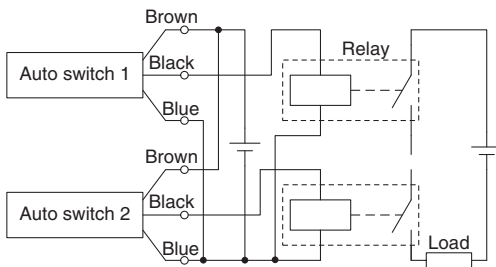

#### (Performed with auto switches only)

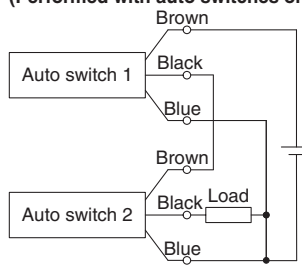

#### 3-wire OR connection for PNP output

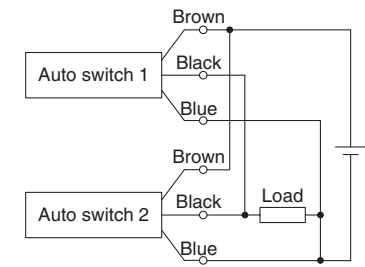

#### 2-wire AND connection

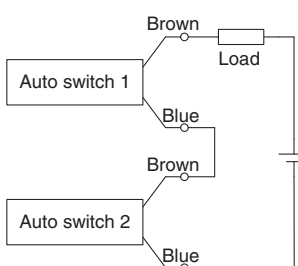

When two auto switches are connected in series, a load may malfunction because the load voltage will decline when in the ON state. The indicator lights will light up when both of the auto switches are in the ON state. Auto switches with load voltage less than 20 V cannot be used.

$$\begin{aligned} \text{Load voltage at ON} &= \text{Power supply voltage} - \text{Residual voltage} \times 2 \text{ pcs.} \\ &= 24 \text{ V} - 4 \text{ V} \times 2 \text{ pcs.} \\ &= 16 \text{ V} \end{aligned}$$

Example: Power supply is 24 V DC  
Internal voltage drop in auto switch is 4 V.

#### 2-wire OR connection

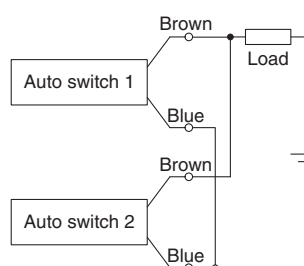

(Solid state)  
When two auto switches are connected in parallel, malfunction may occur because the load voltage will increase when in the OFF state.

(Reed)  
Because there is no current leakage, the load voltage will not increase when turned OFF. However, depending on the number of auto switches in the ON state, the indicator lights may sometimes grow dim or not light up, due to the dispersion and reduction of the current flowing to the auto switches.

$$\begin{aligned} \text{Load voltage at OFF} &= \text{Leakage current} \times 2 \text{ pcs.} \times \text{Load impedance} \\ &= 1 \text{ mA} \times 2 \text{ pcs.} \times 3 \text{ k}\Omega \\ &= 6 \text{ V} \end{aligned}$$

Example: Load impedance is 3 kΩ.  
Leakage current from auto switch is 1 mA.

Basic Type  
MGP-Z

With Air Cushion  
MGP-AZ

With End Lock  
MGP

Heavy Duty Guide Rod Type  
MGPS

Auto Switch

Made to Order

# Series MGP

# Simple Specials/Made to Order



Please contact SMC for detailed specifications, delivery and prices.

## Simple Specials

The following special specifications can be ordered as a simplified Made-to-Order. There is a specification sheet available on paper and CD-ROM. Please contact your SMC sales representatives if necessary.

Symbol	Specifications	Basic type			With air cushion		
		Slide bearing	Ball bushing	High precision ball bushing	Slide bearing	Ball bushing	High precision ball bushing
		MGPM	MGPL	MGPA	MGPM-A	MGPL-A	MGPA-A
-XA□	Change of guide rod end shape	●	●	●			
-XC79	Tapped hole, drilled hole, pinned hole machined additionally	●	●	●	●	●	●

## Made to Order

Symbol	Specifications	Basic type			With air cushion		
		Slide bearing	Ball bushing	High precision ball bushing	Slide bearing	Ball bushing	High precision ball bushing
		MGPM	MGPL	MGPA	MGPM	MGPL	MGPA
-XB6	Heat resistant cylinder (-10 to 150 °C)	●					
-XB10	Intermediate stroke (Using exclusive body)	●	●	●			
-XB13	Low speed cylinder (5 to 50 mm/s)	●	●				
-XB22	Shock absorber soft type <i>series RJ type</i>	●	●				
-XC4	With heavy duty scraper	●	●	●			
-XC6	Made of stainless steel	●	●				
-XC8	Adjustable stroke cylinder/Adjustable extension type	●	●	●			
-XC9	Adjustable stroke cylinder/Adjustable retraction type	●	●	●			
-XC19	Intermediate stroke (Spacer type)				●	●	●
-XC22	Fluororubber seal	●					
-XC35	With coil scraper	●	●	●			
-XC69	With shock absorber *1	●	●	●			
-XC82	Bottom mounting type	●					
-XC85	Grease for food processing equipment	●	●	●	●	●	●
-XC88	Spatter resistant coil scraper, Lube-retainer, Grease for welding (Rod parts: Stainless steel 304)	●					
-XC89	Spatter resistant coil scraper, Lube-retainer, Grease for welding (Rod parts: S45C)	●					
-XC91	Spatter resistant coil scraper, Grease for welding (Rod parts: S45C)	●					
-XC92	Dust resistant actuator *1	●					
-X144	Symmetrical port position	●	●	●			
-X471	Enlarged Plate and Body Gap Dimensions	●					
-X867	Side porting type (Plug location changed)	●	●	●	●	●	●

\*1: The shape is the same as the current product.



# Series MGP Simple Specials

These changes are dealt with Simple Specials System.  
For details, refer to the **Auto Switch Guide**.



Symbol

## 1 Change of Guide Rod End Shape

**-XA1/6/17/21**

### Applicable Series

Description	Model	Action	Symbol for change of rod end shape
Standard type	MGPM-Z	Double acting	XA1, 6, 17, 21
	MGPL-Z	Double acting	
	MGPA-Z	Double acting	

### Precautions

- Ensure that the cylinder's overall length should not exceed the allowable overall length. In the case of exceeding the allowable overall length, it will be available as specials.
- In Fig. (1), (2) below, E' dimension cannot make it into E dimension or less of the standard products. Confirm by referring to catalogue.
- SMC will make appropriate arrangements if no dimension, tolerance, or finish instructions are given in the diagram.
- \* dimension should be the guide rod diameter (D) – 2 mm. In the case that the preferred dimension is different, fill in that dimension.

[mm]	
Bore size	Allowable overall length of cylinder
12,16	345
20 to 32	540
40 to 63	561
80,100	603

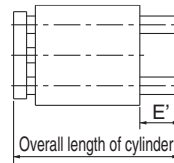

Fig. (1) XA1, XA6

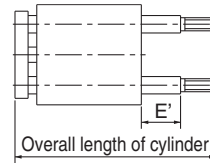

Fig. (2) XA17, XA21

### Guide Rod End Shape Pattern

<b>-XA1</b>	<b>-XA6</b>
<p>(Standard body dimensions) E</p>	<p>(Standard body dimensions) E</p>
<b>-XA17</b>	<b>-XA21</b>
<p>(Standard body dimensions) E A</p>	<p>(Standard body dimensions) E A</p>



Symbol  
**-XC79**

## 2 Tapped Hole, Drilled Hole, Pinned Hole Machined Additionally

This simple special is meant for machining additionally tapped hole, drilled hole, and pinned hole, as requested from customer, on parts designed largely for mounting a workpiece etc. in the combined air cylinders.

But, for each model, since they have the portions which are impossible to machine additionally, refer to the additional machining limitation.

### Applicable Series

Description	Model	Action	Component parts applicable for additional machining
Standard type	MGPM-Z	Double acting	Plate
	MGPL-Z	Double acting	
	MGPA-Z	Double acting	
With air cushion	MGPM-AZ	Double acting	
	MGPL-AZ	Double acting	
	MGPA-AZ	Double acting	
With end lock	MGPM	Double acting	
	MGPL	Double acting	
	MGPA	Double acting	

### Precautions

- We cannot take any responsibility as for the intensity of holes machined additionally and the effects of decreased intensity for the product itself.
- It will not be plated again for the machined part additionally.
- Be sure to fill in "through" for through-hole, and "effective depth" for blind hole.
- When using by machining through-hole additionally, ensure that the tip of the bolt etc. for mounting workpiece should not stick into the cylinder side. It may result in an unexpected problem.
- Use caution not to interfere the existing mounting hole on the standard products with the hole to be machined additionally. But it is possible to drill additionally the larger size of hole at the same position as the existing hole.

### Common Complementary Explanation/Holes which can be additionally machined are the following 3 types.

Tapped hole	Drilled hole	Pinned hole												
<p>Designated nominal diameter and tapped hole of a pitch are machined additionally. (Maximum nominal thread diameter M20)</p> <p>Blind hole is deep into the bottom of prepared hole which sums up A to C in the figure below in contrast to the effective depth of tapped hole. When there is a condition which does not allow through-hole etc., leave sufficient thickness in the inner part of hole.</p>	<p>Drilled hole of a designated internal diameter is machined. (Maximum hole diameter 20 mm)</p> <p>If you wish for blind hole, instruct us with effective depth. (Refer to the figure below.) Besides, dimensional accuracy for internal diameter will be <math>\pm 0.2</math> mm.</p>	<p>Pinned hole of a designated diameter (reamer hole) is machined. (Maximum hole diameter 20 mm)</p> <p>Internal dimension tolerates H9 tolerance to the designated hole diameter. (Refer to the table below.)</p> <table border="1"> <thead> <tr> <th>Hole dia.</th> <th>3 or less</th> <th>Over 3 to 6</th> <th>Over 6 to 10</th> <th>Over 10 to 18</th> <th>Over 18 to 20</th> </tr> </thead> <tbody> <tr> <td>Tolerance</td> <td>+0.01 0</td> <td>+0.012 0</td> <td>+0.015 0</td> <td>+0.018 0</td> <td>+0.021 0</td> </tr> </tbody> </table>	Hole dia.	3 or less	Over 3 to 6	Over 6 to 10	Over 10 to 18	Over 18 to 20	Tolerance	+0.01 0	+0.012 0	+0.015 0	+0.018 0	+0.021 0
Hole dia.	3 or less	Over 3 to 6	Over 6 to 10	Over 10 to 18	Over 18 to 20									
Tolerance	+0.01 0	+0.012 0	+0.015 0	+0.018 0	+0.021 0									

### Limitation for Machining Additionally/Since the slanted lines denote the restricted range for machining additionally, design the dimensions, referring to below.

Plate material: Steel

Bore size	Dimensional Range Not Possible to Machine Additionally [mm]		
	A	B	C
12	8	11	41
16	10	13	46
20	12	15	54
25	14	21	64
32	25	25	78
40	25	25	86
50	30	30	110
63	30	30	124
80	34	34	156
100	42	42	188

Basic Type  
**MGP-Z**

With Air Cushion  
**MGP-AZ**

With End Lock  
**MGP**

Heavy Duty Guide Rod Type  
**MGPS**

Auto Switch

Made to Order

# Series MGP

## Made to Order

Please contact SMC for detailed dimensions, specifications and lead times.



### 1 Heat Resistant Cylinder (-10 to 150 °C)

Symbol

**-XB6**

Air cylinder which changed the seal material and grease, so that it could be used even at higher temperature up to 150 from -10 °C.

#### Applicable Series

Description	Model	Action
Standard type	MGPM-Z	Double acting

- \*: Operate without lubrication from a pneumatic system lubricator.
- \*: Please contact SMC for details on the maintenance intervals for this cylinder, which differ from those of the standard cylinder.
- \*: In principle, it is impossible to make built-in magnet type and the one with auto switch. But, as for the one with auto switch, and the heat resistant cylinder with heat resistant auto switch, since it will be differed depending on the series, please contact SMC.
- \*: Piston speed is ranged from 50 to 500 mm/s. But, for  $\varnothing 80$  and  $\varnothing 100$ , it will be 50 to 400 mm/s.
- \*: No cushion is equipped. Check the kinetic energy.
- \*: Use the following grease pack for the maintenance work:  
**GR-F-010** (Grease: 10 g)

#### How to Order

MGPM Standard model no. -XB6  
Heat resistant cylinder ●

#### Warning Precautions

Be aware that smoking cigarettes etc. after your hands have come into contact with the grease used in this cylinder can create a gas that is hazardous to humans.

#### Specifications

<b>Ambient temperature range</b>	-10 °C to 150 °C
<b>Seal material</b>	Fluororubber
<b>Grease</b>	Heat resistant grease
<b>Specifications other than above</b>	Same as standard type

#### Dimensions

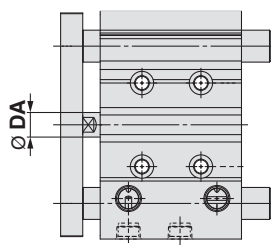

[mm]	
Bore size [mm]	DA
12	(6)
16	(8)
20	(10)
25	(10)
32	(14)
40	(14)
50	20
63	20
80	25
100	30

The dimensions in ( ) are the same as standard type.

### 2 Intermediate Stroke (Using exclusive body)

Symbol

**-XB10**

Cylinder which can reduce the mounting space by using an exclusive body which does not use a spacer to achieve that the full length dimension could be shortened when an intermediate stroke other than the standard stroke is required.

#### Applicable Series

Description	Model	Action
Standard type	MGPM-Z	Double acting
	MGPL-Z	Double acting
	MGPA-Z	Double acting

#### How to Order

MGP <sup>M</sup><sub>L</sub><sub>A</sub> Standard model no. -XB10  
Intermediate stroke ●

**Specifications: Same as standard type**

**2 Intermediate Stroke (Using exclusive body)**

Symbol  
**-XB10**

**Dimensions**

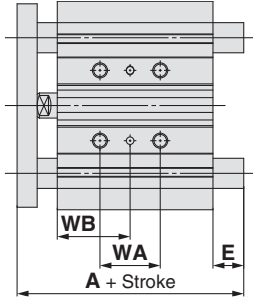

**Stroke Range**

Bore size [mm]	Stroke range [mm]
12, 16	11 to 249
20, 25	21 to 399
32, 40, 50, 63, 80, 100	26 to 399

\*: Specifications except the stroke range are the same as standard.  
\*: Applicable stroke available in 1 mm increments.

**MGPM, MGPL, MGPA/WA, WB Dimensions**

Bore size [mm]	Stroke range [mm]	WA				WB			
		11 to 39 st	41 to 99 st	101 to 199 st	201 to 249 st	11 to 39 st	41 to 99 st	101 to 199 st	201 to 249 st
12	11 to 249	20	40	110	200	15	25	60	105
16		24	44	110	200	17	27	60	105

Bore size [mm]	Stroke range [mm]	WA					WB				
		21 to 39 st	41 to 124 st	126 to 199 st	201 to 299 st	301 to 399 st	21 to 39 st	41 to 124 st	126 to 199 st	201 to 299 st	301 to 399 st
20	21 to 399	24	44	120	200	300	29	39	77	117	167
25		24	44	120	200	300	29	39	77	117	167

Bore size [mm]	Stroke range [mm]	WA					WB				
		26 to 49 st	51 to 124 st	126 to 199 st	201 to 299 st	301 to 399 st	26 to 49 st	51 to 124 st	126 to 199 st	201 to 299 st	301 to 399 st
32	26 to 399	24	48	124	200	300	33	45	83	121	171
40		24	48	124	200	300	34	46	84	122	172
50		24	48	124	200	300	36	48	86	124	174
63		28	52	128	200	300	38	50	88	124	174
80		28	52	128	200	300	42	54	92	128	178
100		48	72	148	220	320	35	47	85	121	171

**MGPM/A, E Dimensions**

Bore size [mm]	A			E		
	11 to 74 st	76 to 99 st	101 to 249 st	11 to 74 st	76 to 99 st	101 to 249 st
12	42	60.5	82.5	0	18.5	40.5
16	46	64.5	92.5	0	18.5	46.5

Bore size [mm]	A			E		
	21 to 74 st	76 to 199 st	201 to 399 st	21 to 74 st	76 to 199 st	201 to 399 st
20	53	77.5	110	0	24.5	57
25	53.5	77.5	109.5	0	24	56

Bore size [mm]	A			E		
	26 to 74 st	76 to 199 st	201 to 399 st	26 to 74 st	76 to 199 st	201 to 399 st
32	75	93.5	129.5	15.5	34	70
40	75	93.5	129.5	9	27.5	63.5
50	88.5	109.5	150.5	16.5	37.5	78.5
63	88.5	109.5	150.5	11.5	32.5	73.5
80	104.5	131.5	180.5	8	35	84
100	126.5	151.5	190.5	10.5	35.5	74.5

\*: Dimensions except mentioned above are the same as standard type.

**MGPL, MGPA/A,E Dimensions**

Bore size [mm]	A			E		
	11 to 39 st	41 to 99 st	101 to 249 st	10 to 39 st	41 to 99 st	101 to 249 st
12	43	55	84.5	1	13	42.5
16	49	65	94.5	3	19	48.5

Bore size [mm]	A				E			
	21 to 39 st	41 to 124 st	126 to 199 st	201 to 399 st	21 to 39 st	41 to 124 st	126 to 199 st	201 to 399 st
20	59	76	100	117.5	6	23	47	64.5
25	65.5	81.5	100.5	117.5	12	28	47	64

Bore size [mm]	A				E			
	26 to 74 st	76 to 124 st	126 to 199 st	201 to 399 st	26 to 74 st	76 to 124 st	126 to 199 st	201 to 399 st
32	79.5	96.5	116.5	138.5	20	37	57	79
40	79.5	96.5	116.5	138.5	13.5	30.5	50.5	72.5
50	91.5	112.5	132.5	159.5	19.5	40.5	60.5	87.5
63	91.5	112.5	132.5	159.5	14.5	35.5	55.5	82.5

Bore size [mm]	A				E			
	26 to 49 st	51 to 74 st	76 to 199 st	201 to 399 st	26 to 49 st	51 to 74 st	76 to 199 st	201 to 399 st
80	104.5	128.5	158.5	191.5	8	32	62	95
100	119.5	145.5	178.5	201.5	3.5	29.5	62.5	85.5

**3 Low Speed Cylinder (5 to 50 mm/s)**

Symbol  
**-XB13**

Even if driving at lower speeds 5 to 50 mm/s, there would be no stick-slip phenomenon and it can run smoothly.

**Applicable Series**

Description	Model	Action
Standard type	MGPM-Z	Double acting
	MGPL-Z	Double acting

**How to Order**

MGP<sup>M</sup><sub>L</sub> Standard model no. -XB13  
 ↓  
 Low speed cylinder

\*: Operation may be unstable depending on the operating conditions.

**Specifications**

<b>Piston speed</b>	5 to 50 mm/s
<b>Dimensions</b>	Same as standard type
<b>Specifications other than above</b>	Same as standard type

\*: Operate without lubrication from a pneumatic system lubricator.  
 \*: For the speed adjustment, use speed controllers for controlling at lower speeds. (Series AS-FM/AS-M)  
 \*: Use the following grease pack for the maintenance work:  
**GR-F-010** (Grease: 10 g)

**Warning Precautions**

Be aware that smoking cigarettes etc. after your hands have come into contact with the grease used in this cylinder can create a gas that is hazardous to humans.

Basic Type **MGP-Z**  
 With Air Cushion **MGP-AZ**  
 With End Lock **MGP**  
 Heavy Duty Guide Rod Type **MGPS**  
 Auto Switch

## 4 Shock Absorber Soft Type *Series RJ* Type

The standard cylinder has been equipped with shock absorber soft type *series RJ* type to enable soft stopping at the stroke end. Two different shock absorbers are available in accordance with the operating conditions.

### Applicable Series

Description	Model	Action
Standard type	MGPM-Z	Double acting
	MGPL-Z	Double acting

### How to Order

MGP <sup>M</sup><sub>L</sub> Standard model no. -XB22  
 ● Shock absorber soft type *series RJ* type

### Specifications

Performance, absorbed energy	Refer to the table below and the maximum impact mass graph.
Dimensions	Shock absorber overall length: 0 to -1.4 mm shorter than the standard type
Specifications other than above	Same as standard type

Model	RJ/H type		
	RJ0806H	RJ1007H	RJ1412H
Max. energy absorption [J] *1	1	3	10
O.D. thread size [mm]	8	10	14
Stroke [mm]	6	7	12
Collision speed [m/s]	0.05 to 2		
Max. operating frequency [cycle/min] *1	80	70	45
Spring force [N]	Extended	5.4	6.4
	Retracted	8.4	17.4
Max. allowable thrust [N]	245	422	814
Ambient temperature [°C]	-10 to 60 °C (No freezing)		
Weight [g]	Basic	23	65

\*1: At ordinary temperature (20 to 25 °C)

- \* For details about the shock absorber soft type *RJ series*, refer to the catalogue on [www.smc.eu](http://www.smc.eu).
- \* The shock absorber service life is different from that of each cylinder. Refer to the Specific Product Precautions of the *RJ series* for the replacement period.

### Cylinders

\*: Refer to the catalogue on [www.smc.eu](http://www.smc.eu) for the details of the shock absorber RB series.

#### Guide Cylinder

Model	Type	Bore size					
		Ø 12	Ø 16	Ø 20	Ø 25	Ø 32	Ø 40
MGP	-XB22	RJ0806H		RJ1007H		RJ1412H	
	-XC69	RB0806		RB1007		RB1412	

**4 Shock Absorber Soft Type Series RJ Type**

Symbol  
**-XB22**

**Maximum Impact Mass Graph (Shock Absorber Performance Line Graph)**

\*: Values in the maximum impact mass graph are at room temperature (20 to 25 °C).

Ensure that the impact mass and the impact speed are within the absorbed energy graphs below.  
Refer to each cylinder selection calculation for load factors and guide load factors.  
Please consult with SMC for the MY3 series because of restrictions regarding the cylinder.

**■ Type of collision**

Horizontally-applied impact Air cylinder impact (horizontal/upward)

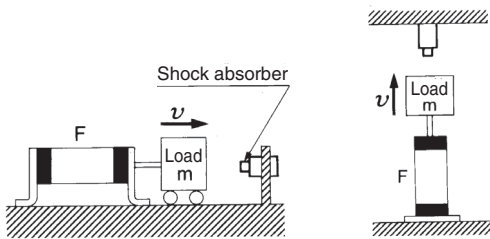

Air cylinder impact (downward)

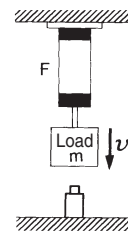

**RJ0806H Absorbed Energy**

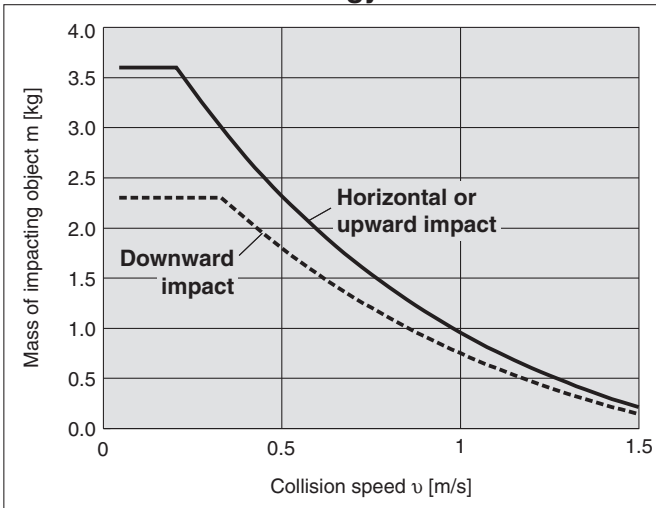

**RJ1007H Absorbed Energy**

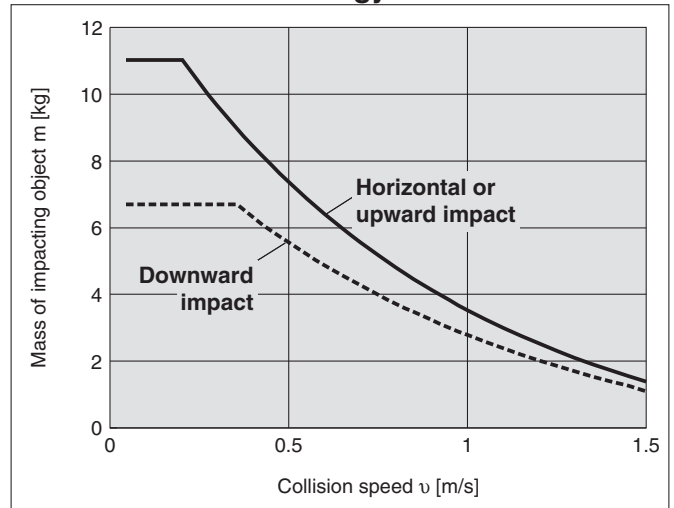

**RJ1412H Absorbed Energy**

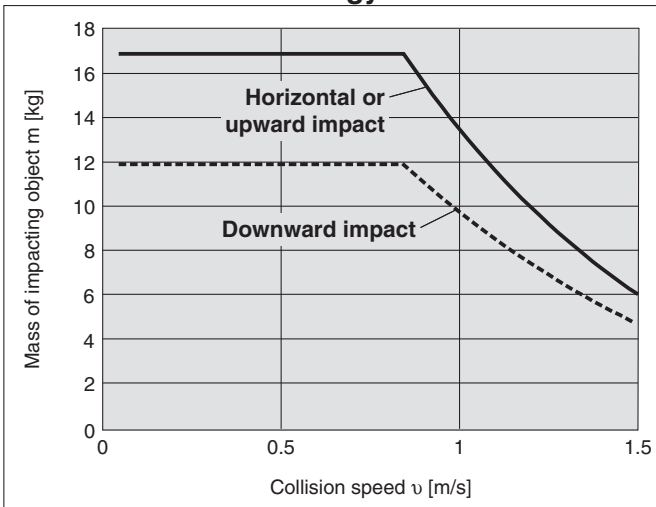

\*: Be sure to read the Handling Precautions for SMC Products (M-E03-3) and Shock Absorber Soft Type RJ Series before use.

Basic Type **MGP-Z**  
With Air Cushion **MGP-AZ**  
With End Lock **MGP**  
Heavy Duty Guide Rod Type **MGPS**  
Auto Switch  
Made to Order

## 5 With Heavy Duty Scraper

It is suitable for using cylinders under the environment, where there are much dusts in a surrounding area by using a heavy duty scraper on the wiper ring, or using cylinders under earth and sand exposed to the die-casted equipment, construction machinery, or industrial vehicles.

### Applicable Series

Description	Model	Action
Standard type	MGPM-Z	Double acting
	MGPL-Z	Double acting
	MGPA-Z	Double acting

### How to Order

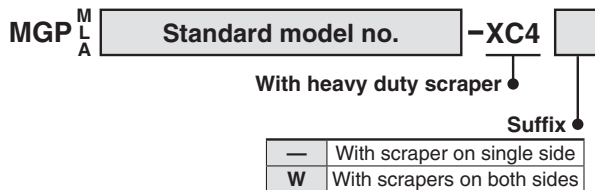

### Specifications

Applicable series		MGPM	MGPL/MGPA
<b>Bearing type</b>		Slide bearing	Ball bushing
<b>Bore size [mm]</b>		20, 25, 32, 40, 50, 63, 80, 100	
<b>Minimum operating pressure</b>	On single side	0.12 MPa	
	On both sides	0.14 MPa	
<b>Specifications other than above</b>		Same as standard type	

### ⚠ Caution

**Do not replace heavy duty scrapers.**

- Since heavy duty scrapers are press-fit, they must be replaced together with the holder plate assembly.

### Dimensions (Dimensions other than below are the same as standard type.)

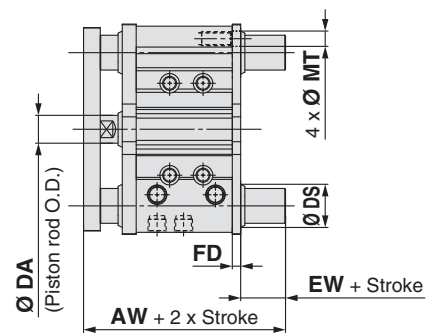
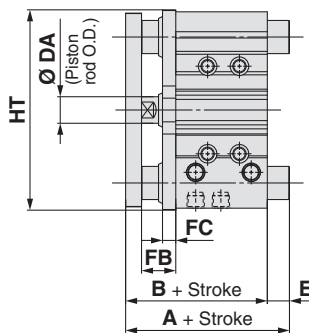

**A cylinder with scrapers on both sides**

### MGPM, MGPL, MGPA Common Dimensions [mm]

Bore size [mm]	B	DA	FB	FC	
				MGPM	MGPL/MGPA
20	63	(10)	18	9	5
25	63.5	(10)	17	9	5
32	69.5	(14)	22	9	5
40	76	(14)	22	9	5
50	82	20	26	10	8
63	87	20	26	10	5
80	106.5	25	34	15	6
100	126	30	41	15	6

The dimensions in ( ) are the same as standard type.

### With Scrapers on Both Sides/AW, EW, FD, MT, DS Dimensions [mm]

Bore size [mm]	AW	EW	FD	MT	DS*1	
					MGPM	MGPL/MGPA
20	74	6	5	6	17	15
25	74.5	6	5	7	21	19
32	82.5	7	6	8.5	26	21
40	89	7	6	8.5	26	21
50	95	7	6	11	31	26
63	100	7	6	11	31	26
80	120.5	8	6	14	36	31
100	143	8	9	16	44	36

\*1: Bypass port for guide rod with bottom mounting

### MGPM (Slide bearing)/A, E, HT Dimensions [mm]

Bore size [mm]	A			E			HT
	50 st or less	Over 50 st to 200 st	Over 200 st	50 st or less	Over 50 st to 200 st	Over 200 st	
20	63	87.5	120	0	24.5	57	80
25	63.5	87.5	119.5	0	24	56	93
32	85	103.5	139.5	15.5	34	70	111.5
40	85	103.5	139.5	9	27.5	63.5	119
50	98.5	119.5	160.5	16.5	37.5	78.5	151
63	98.5	119.5	160.5	11.5	32.5	73.5	165
80	114.5	141.5	190.5	8	35	84	202
100	136.5	161.5	200.5	10.5	35.5	74.5	240

### MGPL, MGPA (Ball bushing)/A, E, HT Dimensions [mm]

Bore size [mm]	A				E				HT
	30 st or less	Over 30 st to 100 st	Over 100 st to 200 st	Over 200 st	30 st or less	Over 30 st to 100 st	Over 100 st to 200 st	Over 200 st	
20	69	86	110	127.5	6	23	47	64.5	80
25	75.5	91.5	110.5	127.5	12	28	47	64	93

Bore size [mm]	A				E				HT
	50 st or less	Over 50 st to 100 st	Over 100 st to 200 st	Over 200 st	50 st or less	Over 50 st to 100 st	Over 100 st to 200 st	Over 200 st	
32	89.5	106.5	126.5	148.5	20	37	57	79	110
40	89.5	106.5	126.5	148.5	13.5	30.5	50.5	72.5	118
50	101.5	122.5	142.5	169.5	19.5	40.5	60.5	87.5	146
63	101.5	122.5	142.5	169.5	14.5	35.5	55.5	82.5	160

Bore size [mm]	A				E				HT
	25 st or less	Over 25 st to 50 st	Over 50 st to 200 st	Over 200 st	25 st or less	Over 25 st to 50 st	Over 50 st to 200 st	Over 200 st	
80	114.5	138.5	168.5	201.5	8	32	62	95	199
100	129.5	155.5	188.5	211.5	3.5	29.5	62.5	85.5	236

## 6 Made of Stainless Steel

Symbol  
**-XC6**

Suitable for the cases it is likely to generate rust by being immersed in the water and corrosion.

### Applicable Series

Description	Model	Action
Standard type	MGPM-Z	Double acting
	MGPL-Z	Double acting

### Specifications

Parts material changed to stainless steel	A	①, ②, ③, ④, ⑤, ⑥
	B	①, ②, ⑤, ⑥
Specifications other than above and external dimensions	Same as standard type	

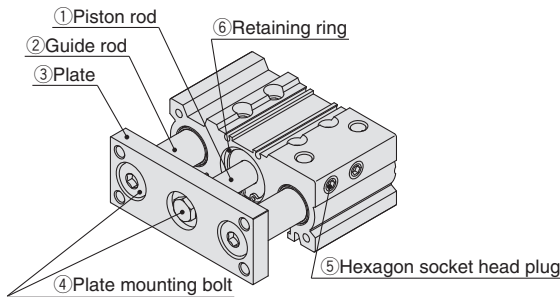

### How to Order

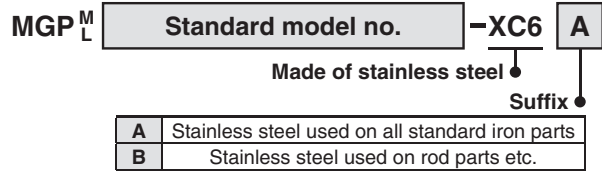

### Dimensions

Bore size [mm]	MGPM, MGPL, -Z-XC6 Common Dimensions [mm]			
	XC6A		XC6B	
	DA	FA	FB	DA
12	(6)	8	5	(6)
16	(8)	8	5	(8)
20	(10)	9	7	(10)
25	(10)	10	6	(10)
32	(14)	12	10	(14)
40	(14)	12	10	(14)
50	20	16	12	20
63	20	16	12	20
80	25	19	21	25
100	30	22	28	30

The dimensions in ( ) are the same as standard type.

## 7 Adjustable Stroke Cylinder/Adjustable Extension Type

Symbol  
**-XC8**

It adjusts the extending stroke by the stroke adjustable mechanism equipped in the head side. (After the stroke is adjusted, with cushion on both sides is altered to single-sided, with cushion.)

### Applicable Series

Description	Model	Action
Standard type	MGPM-Z	Double acting
	MGPL-Z	Double acting
	MGPA-Z	Double acting

### How to Order



### Precautions

#### ⚠ Warning

- When the cylinder is operating, if something gets caught between the stopper bracket for adjusting the stroke and the cylinder body, it could cause bodily injury or damage the peripheral equipment. Therefore, take preventive measures as necessary, such as installing a protective cover.
- To adjust the stroke, make sure to secure the wrench flats of the stopper bracket by a wrench etc. before loosening the lock nut. If the lock nut is loosened without securing the stopper bracket, be aware that the area that joins the load to the piston rod or the area in which the piston rod is joined with the load side and the stopper bracket side could loosen first. It may cause an accident or malfunction.

### Symbol

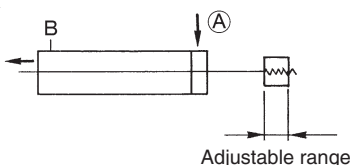

### Specifications

Stroke adjustment symbol	A	B
Stroke adjustment range [mm]	0 to 10	0 to 25
Specifications other than above	Same as standard type	

### Dimensions (Dimensions other than below are the same as standard type.)

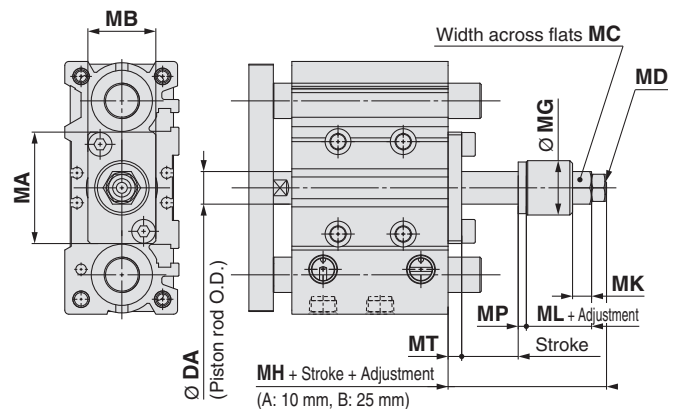

### MGPM, MGPL, MGPA Common Dimensions [mm]

Bore size [mm]	DA	MA	MB	MC	MD	∅ MG	MH	MK	ML	MP	MT
12	(6)	27	13	8	M4 x 0.7	14	20	5.5	10	3	3
16	(8)	28	16	10	M5 x 0.8	14	20	5.5	10	3	3
20	(10)	33	22	12	M6 x 1	20	26	7	14	3	4
25	12	41	25	12	M6 x 1	20	27	7	14	3	5
32	16	51	32	17	M8 x 1.25	25	35	9	18.5	4	6
40	16	60	32	19	M10 x 1.25	25	35	10	17	4	6
50	20	71	38	24	M14 x 1.5	35	46	13	21	4	8
63	20	84	50	24	M14 x 1.5	35	46	13	21	4	8
80	25	114	50	32	M20 x 1.5	45	55	16	30	4	9
100	30	140	65	32	M20 x 1.5	45	58	16	30	4	12

The dimensions in ( ) are the same as standard type.

Basic Type  
**MGP-Z**

With Air Cushion  
**MGP-AZ**

With End Lock  
**MGP**

Heavy Duty Guide Rod Type  
**MGPS**

Auto Switch

Made to Order

## 8 Adjustable Stroke Cylinder/Adjustable Retraction Type

The retract stroke of the cylinder can be adjusted by the adjustment bolt.

### Applicable Series

Description	Model	Action
Standard type	MGPM-Z	Double acting
	MGPL-Z	Double acting
	MGPA-Z	Double acting

### How to Order

MGP<sup>M</sup><sub>L</sub><sub>A</sub> **Bore size** - **Stroke** **Stroke adjustment symbol** Z - XC9  
Adjustable stroke cylinder/Adjustable retraction type ●

### Precautions

#### ⚠ Caution

- When air is supplied to the cylinder, if the stroke adjustment bolt is loosened in excess of the allowable stroke adjustment amount, be aware that the stroke adjustment bolt could fly out or air could be discharged, which could injure personnel or damage the peripheral equipment.
- Adjust the stroke when the cylinder is not pressurised. If it is adjusted in the pressurised state, the seal of the adjustment section could become deformed, leading to air leakage.

### Symbol

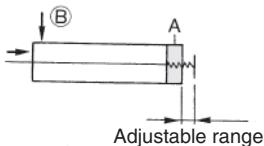

### Specifications

Stroke adjustment symbol	A	B
<b>Stroke adjustment range [mm]</b>	0 to 10	0 to 25
<b>Specifications other than above</b>	Same as standard type	

### Dimensions (Dimensions other than below are the same as standard type.)

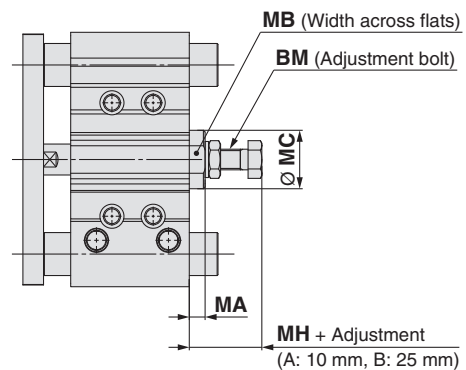

### MGPM, MGPL, MGPA Common Dimensions [mm]

Bore size [mm]	BM	MA	MB	MC	MH
12	M5 x 0.8	5	8	12.5	17
16	M6 x 1	5	10	14	19
20	M8 x 1.25	6.5	13	16	25
25	M8 x 1.25	6.5	13	16	24
32	M8 x 1.25	6.5	19	21	25
40	M12 x 1.5	9	27	30	32.5
50	M12 x 1.5	9	30	34	32.5
63	M16 x 1.5	10	36	40	37
80	M20 x 1.5	15	41	46	48.5
100	M24 x 1.5	18	46	52	55.5



## 9 Intermediate Stroke (Spacer type)

Symbol  
**-XC19**

Dealing with the intermediate stroke by installing a spacer with the standard stroke cylinder.

### Applicable Series

Description	Model	Action
With air cushion	MGPM-AZ	Double acting
	MGPL-AZ	Double acting
	MGPA-AZ	Double acting

### How to Order

MGP<sup>M</sup><sub>L</sub><sub>A</sub> Standard model no. **-XC19**  
Intermediate stroke (Spacer type)

### Applicable Stroke

<b>Description</b>	Dealing with the stroke in 1 mm increments by changing a collar of the standard stroke cylinder. Minimum manufacturable stroke $\varnothing 16$ to $\varnothing 63$ : 15 mm $\varnothing 80, \varnothing 100$ : 20 mm Select a rubber bumper type, because the cushion effect is not obtainable for less than this stroke.	
<b>Model no.</b>	Add "-XC19" to the end of standard part number.	
<b>Applicable stroke [mm]</b>	$\varnothing 16$	15 to 249
	$\varnothing 20$ to $\varnothing 63$	15 to 399
	$\varnothing 80, \varnothing 100$	20 to 399
<b>Example</b>	Part no.: MGPM20-35AZ-XC19 15 mm width collar is installed in MGPM20-50AZ. C dimension is 112 mm.	

\*: Intermediate strokes (in 1 mm increments) with a special body are available as special products.

## 10 Fluororubber Seal

Symbol  
**-XC22**

### Applicable Series

Description	Model	Action
Standard type	MGPM-Z	Double acting

### How to Order

MGPM Standard model no. **-XC22**  
Fluororubber seal

### Specifications

<b>Seal material</b>	Fluororubber
<b>Ambient temperature range</b>	With auto switch *1: -10 °C to 60 °C (No freezing)
<b>Specifications other than above</b>	Same as standard type

\*1: Please confirm with SMC, as the type of chemical and the operating temperature may not allow the use of this product.

\*: No cushion is equipped. Check the kinetic energy.

### Dimensions

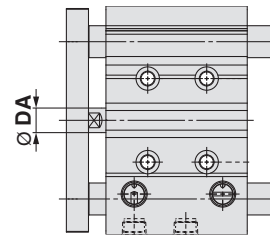

[mm]			
Bore size [mm]	DA	Bore size [mm]	DA
<b>12</b>	(6)	<b>40</b>	(14)
<b>16</b>	(8)	<b>50</b>	20
<b>20</b>	(10)	<b>63</b>	20
<b>25</b>	(10)	<b>80</b>	25
<b>32</b>	(14)	<b>100</b>	30

The dimensions in ( ) are the same as standard type.

Basic Type  
**MGP-Z**

With Air Cushion  
**MGP-AZ**

With End Lock  
**MGP**

Heavy Duty Guide Rod Type  
**MGPS**

**Auto Switch**

**Made to Order**

## 11 With Coil Scraper

It gets rid of frost, ice, weld spatter, cutting chips adhered to the piston rod, and protects the seals etc.

### Applicable Series

Description	Model	Action
Standard type	MGPM-Z	Double acting
	MGPL-Z	Double acting
	MGPA-Z	Double acting

### How to Order

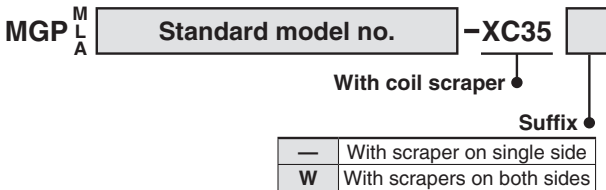

### Specifications

Applicable series		MGPM	MGPL/MGPA
<b>Bearing type</b>		Slide bearing	Ball bushing
<b>Bore size [mm]</b>		20, 25, 32, 40, 50, 63, 80, 100	
<b>Minimum operating pressure</b>	On single side	0.12 MPa	
	On both sides	0.14 MPa	
<b>Specifications other than above</b>		Same as standard type	

### Dimensions (Dimensions other than below are the same as standard type.)

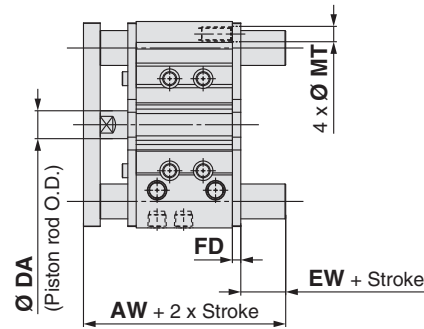
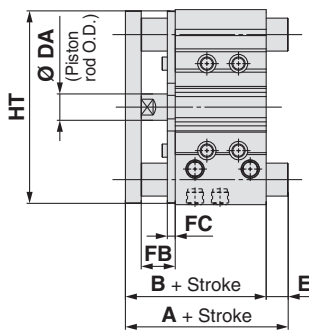

A cylinder with scrapers on both sides

### MGPM, MGPL, MGPA Common Dimensions [mm]

Bore size [mm]	B	DA	FB	FC	
				MGPM	MGPL/MGPA
20	63	(10)	18	5	5
25	63.5	(10)	17	6	5
32	69.5	(14)	22	6	5
40	76	(14)	22	6	5
50	82	20	26	6	5
63	87	20	26	6	5
80	106.5	25	34	8	6
100	126	30	41	9	6

The dimensions in ( ) are the same as standard type.

### With Scrapers on Both Sides/AW, EW, FD, MT Dimensions [mm]

Bore size [mm]	AW	EW	FD	MT
20	74	6	5	6
25	74.5	6	5	7
32	82.5	7	6	9
40	89	7	6	8.5
50	95	7	6	11
63	100	7	6	11
80	120.5	8	6	14
100	143	8	9	16

### MGPM (Slide bearing)/A, E, HT Dimensions [mm]

Bore size [mm]	A			E			HT
	50 st or less	Over 50 st to 200 st	Over 200 st	50 st or less	Over 50 st to 200 st	Over 200 st	
20	63	87.5	120	0	24.5	57	80
25	63.5	87.5	119.5	0	24	56	93
32	85	103.5	139.5	15.5	34	70	110
40	85	103.5	139.5	9	27.5	63.5	118
50	98.5	119.5	160.5	16.5	37.5	78.5	146
63	98.5	119.5	160.5	11.5	32.5	73.5	160
80	114.5	141.5	190.5	8	35	84	199
100	136.5	161.5	200.5	10.5	35.5	74.5	236

### MGPL, MGPA (Ball bushing)/A, E, HT Dimensions [mm]

Bore size [mm]	A				E				HT
	30 st or less	Over 30 st to 100 st	Over 100 st to 200 st	Over 200 st	30 st or less	Over 30 st to 100 st	Over 100 st to 200 st	Over 200 st	
20	69	86	110	127.5	6	23	47	64.5	80
25	75.5	91.5	110.5	127.5	12	28	47	64	93

Bore size [mm]	A				E				HT
	50 st or less	Over 50 st to 100 st	Over 100 st to 200 st	Over 200 st	50 st or less	Over 50 st to 100 st	Over 100 st to 200 st	Over 200 st	
32	89.5	106.5	126.5	148.5	20	37	57	79	110
40	89.5	106.5	126.5	148.5	13.5	30.5	50.5	72.5	118
50	101.5	122.5	142.5	169.5	19.5	40.5	60.5	87.5	146
63	101.5	122.5	142.5	169.5	14.5	35.5	55.5	82.5	160

Bore size [mm]	A				E				HT
	25 st or less	Over 25 st to 50 st	Over 50 st to 200 st	Over 200 st	25 st or less	Over 25 st to 50 st	Over 50 st to 200 st	Over 200 st	
80	114.5	138.5	168.5	201.5	8	32	62	95	199
100	129.5	155.5	188.5	211.5	3.5	29.5	62.5	85.5	236

**12** Series MGP with Shock Absorber

Symbol  
**-XC69**

**How to Order**

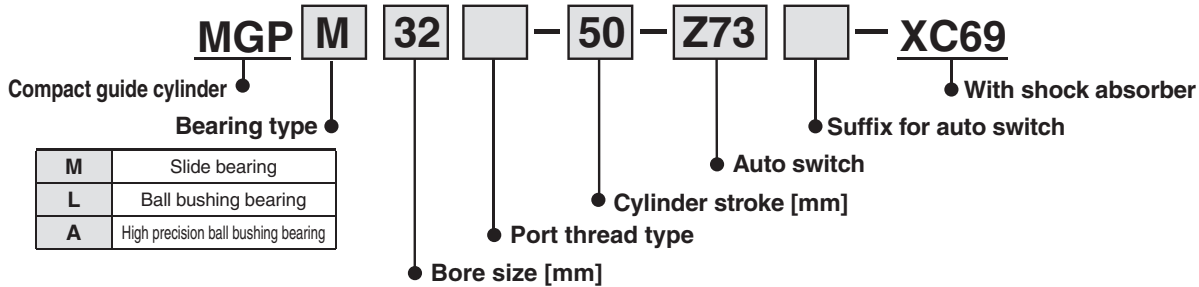

**Specifications of Extension Adjusting Mechanism**

Bore size [mm]	12, 16	20, 25	32, 40	50, 63	80, 100
Shock absorber model	RB0806	RB1007	RB1412	RB2015	RB2725
Maximum energy absorption [J]	2.94	5.88	19.6	58.8	147
Stroke adjustment range [mm]	0 to -15		0 to -25		0 to -30
Piston speed	Refer to the graph below.				

Soft type Series RJ type (-XB22) is also available.  
For details, refer to -XB22.

**Allowable Kinetic Energy**

Work load and cylinder speed should be observed within the range given in the graph below.

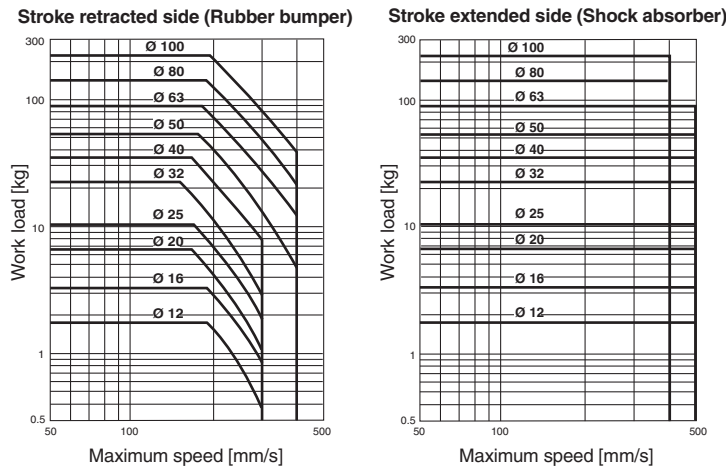

The shock absorber service life is different from that of the MGP cylinder. Refer to the Series RB Specific Product Precautions for the replacement period.

**Mounting**

**Do not allow hands or fingers near the cylinder during its operation.**  
If finger, etc. were to get caught between shock absorber and body, it might damage on the human body and the peripheral equipment. Take protective measures by mounting a protective cover, etc. as necessary.

**Basically, avoid bottom-mounting a cylinder.**  
Mounting space is limited owing to the guide rod and the end plate, etc. Mount a cylinder by the top mounting or side mounting.

**Adjustment**

- How to adjust an adjustment screw (Stroke adjustment)**  
Loosen only the hexagon nut 1, then turn the adjustment screw to adjust the stroke. After adjusting, lock it with the hexagon nut 1. Fix it at the position ejected from the end plate, so that the end face of an adjustment screw could hit the bracket for stopper directly. (Refer to the figure right above.)
- How to replace shock absorbers**  
Loosen hexagon nut 2, and turn a shock absorber counterclockwise for removal. For installing a new shock absorber, fix it at the position that the end face of an adjustment screw sticks out by 0.5 mm from a shock absorber. (Refer to the figure on the right.) After adjusting the position of shock absorber, be sure to secure with hexagon nut 2.

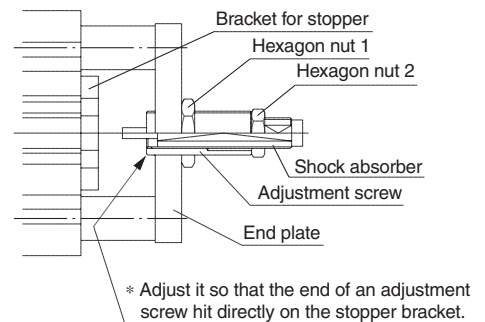

Basic Type  
**MGP-Z**

With Air Cushion  
**MGP-AZ**

With End Lock  
**MGP**

Heavy Duty Guide Rod Type  
**MGPS**

**Auto Switch**

Made to Order

## 12 Series MGP with Shock Absorber

Symbol  
**-XC69**

### Dimensions

Ø 12 to Ø 63

T-slot dimensions

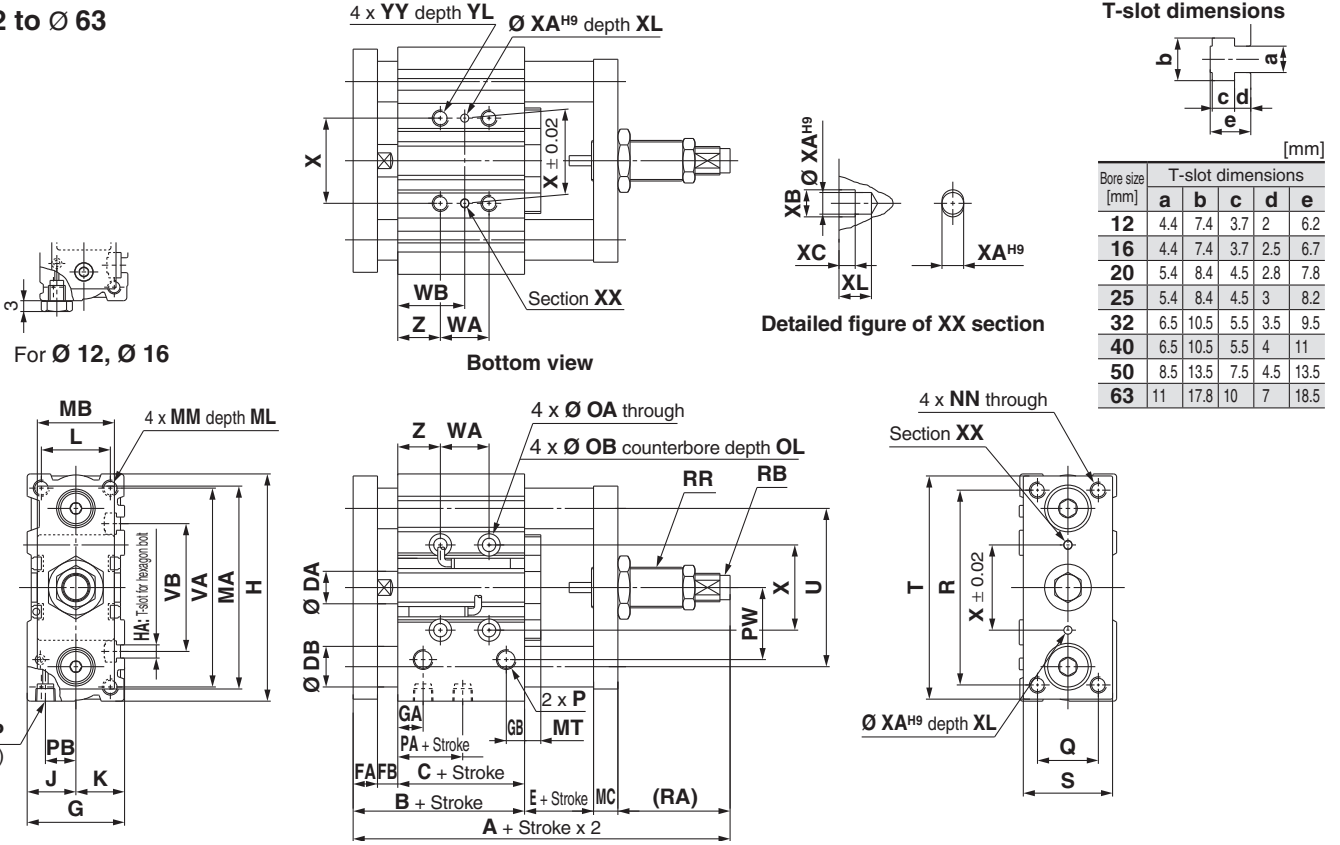

For Ø 12, Ø 16

Bottom view

Detailed figure of XX section

### Common Dimensions

Bore size [mm]	Standard stroke [mm]	A	B	C	DA	DB		E	FA	FB	G	GA	GB	H	HA	J	K	L	MA	MB	MC	MT	MM	ML	NN
		Slide	Ball bushing																						
12	10, 20, 30, 40, 50, 75, 100	90	42	29	6	8	6	7	8	5	26	11	7.5	58	M4	13	13	18	51	19	8	6	M4 x 0.7	10	M4 x 0.7
16	125, 150, 175, 200, 250	94	46	33	8	10	8	7	8	5	30	11	8	64	M4	15	15	22	58	19	8	6	M5 x 0.8	12	M5 x 0.8
20	20, 30, 40, 50, 75, 100, 125, 150	109	53	37	10	12	10	9	10	6	36	10.5	8.5	83	M5	18	18	24	68	30	10	8	M5 x 0.8	13	M5 x 0.8
25	175, 200, 250, 300, 350, 400	109.5	53.5	37.5	12	16	13	9	10	6	42	11.5	9	93	M5	21	21	30	82	30	10	8	M6 x 1.0	15	M6 x 1.0
32	25, 50, 75, 100 125, 150, 175, 200 250, 300, 350, 400	135.5	59.5	37.5	16	20	16	9	12	10	48	12.5	9	112	M6	24	24	34	100	38	12	8	M8 x 1.25	20	M8 x 1.25
40		142	66	44	16	20	16	9	12	10	54	14	10	120	M6	27	27	40	108	38	12	8	M8 x 1.25	20	M8 x 1.25
50		155	72	44	20	25	20	10	16	12	64	14	11	148	M8	32	32	46	139	60	16	9	M10 x 1.5	22	M10 x 1.5
63		160	77	49	20	25	20	10	16	12	78	16.5	13.5	162	M10	39	39	58	153	60	16	9	M10 x 1.5	22	M10 x 1.5

Bore size [mm]	OA	OB	OL	P			PA	PB	PW	Q	R	RA	RB	RR	S	T	U	VA	VB	X	XA	XB	XC	XL	YY	YL	Z
				N	TF																						
12	4.3	8	4.5	M5 x 0.8	—	—	13	8	18	14	48	33	RB0806	M12 x 1.5	22	56	41	50	37	23	3	3.5	3	6	M5 x 0.8	10	5
16	4.3	8	4.5	M5 x 0.8	—	—	15	10	19	16	54	33	RB0806	M12 x 1.5	25	62	46	56	38	24	3	3.5	3	6	M5 x 0.8	10	5
20	5.4	9.5	5.5	Rc 1/8	NPT 1/8	G 1/8	12.5	10.5	25	18	70	37	RB1007	M14 x 1.5	30	81	54	72	44	28	3	3.5	3	6	M6 x 1.0	12	17
25	5.4	9.5	5.5	Rc 1/8	NPT 1/8	G 1/8	12.5	13.5	30	26	78	37	RB1007	M14 x 1.5	38	91	64	82	50	34	4	4.5	3	6	M6 x 1.0	12	17
32	6.6	11	7.5	Rc 1/8	NPT 1/8	G 1/8	7	15	35.5	30	96	55	RB1412	M20 x 1.5	44	110	78	98	63	42	4	4.5	3	6	M8 x 1.25	16	21
40	6.6	11	7.5	Rc 1/8	NPT 1/8	G 1/8	13	18	39.5	30	104	55	RB1412	M20 x 1.5	44	118	86	106	72	50	4	4.5	3	6	M8 x 1.25	16	22
50	8.6	14	9	Rc 1/4	NPT 1/4	G 1/4	9	21.5	47	40	130	57	RB2015	M27 x 1.5	60	146	110	130	92	66	5	6	4	8	M10 x 1.5	20	24
63	8.6	14	9	Rc 1/4	NPT 1/4	G 1/4	14	28	58	50	130	57	RB2015	M27 x 1.5	70	158	124	142	110	80	5	6	4	8	M10 x 1.5	20	24

### MGP12 to 25 WA, WB Dimensions [mm]

Bore size [mm]	WA					WB				
	30 st or less	Over 30 st to 100 st	Over 100 st to 200 st	Over 200 st to 300 st	Over 300 st	30 st or less	Over 30 st to 100 st	Over 100 st to 200 st	Over 200 st to 300 st	Over 300 st
12	20	40	110	200	—	15	25	60	105	—
16	24	44	110	200	—	17	27	60	105	—
20	24	44	120	200	300	29	39	77	117	167
25	24	44	120	200	300	29	39	77	117	167

### MGP32 to 63 WA, WB Dimensions [mm]

Bore size [mm]	WA					WB				
	25 st or less	Over 25 st to 100 st	Over 100 st to 200 st	Over 200 st to 300 st	Over 300 st	25 st or less	Over 25 st to 100 st	Over 100 st to 200 st	Over 200 st to 300 st	Over 300 st
32	24	48	124	200	300	33	45	83	121	171
40	24	48	124	200	300	34	46	84	122	172
50	24	48	124	200	300	36	48	86	124	174
63	28	52	128	200	300	38	50	88	124	174

\*: Bore size 12 and 16: M5 x 0.8 port only  
\*: Bore size over 20: Rc, NPT or G ports selectable

**12** Series MGP with Shock Absorber

Symbol  
**-XC69**

**Dimensions**

Ø 80 to Ø 100

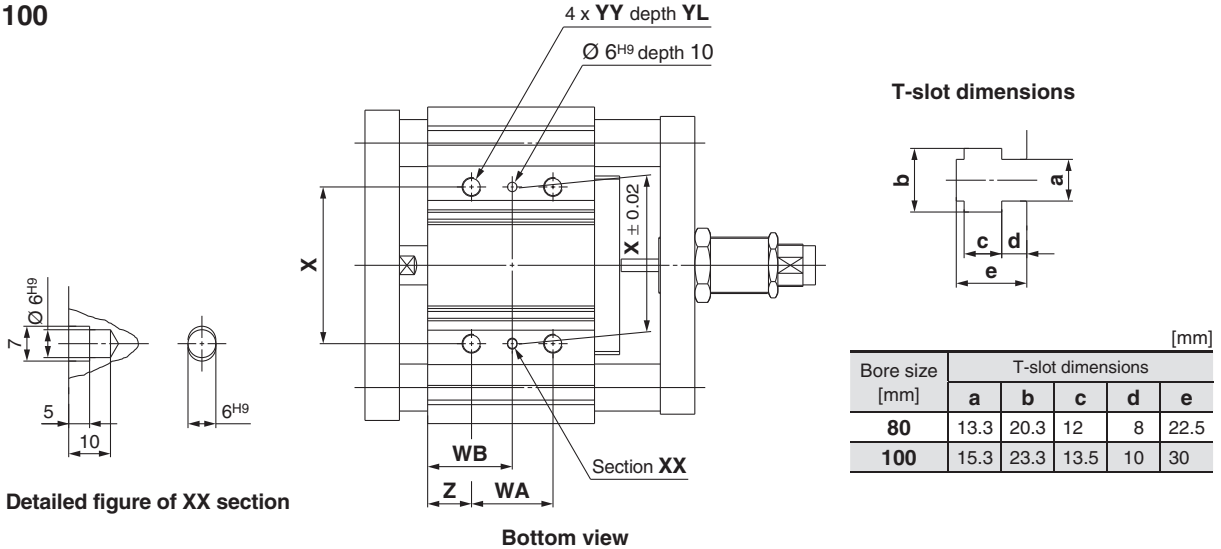

Detailed figure of XX section

Bottom view

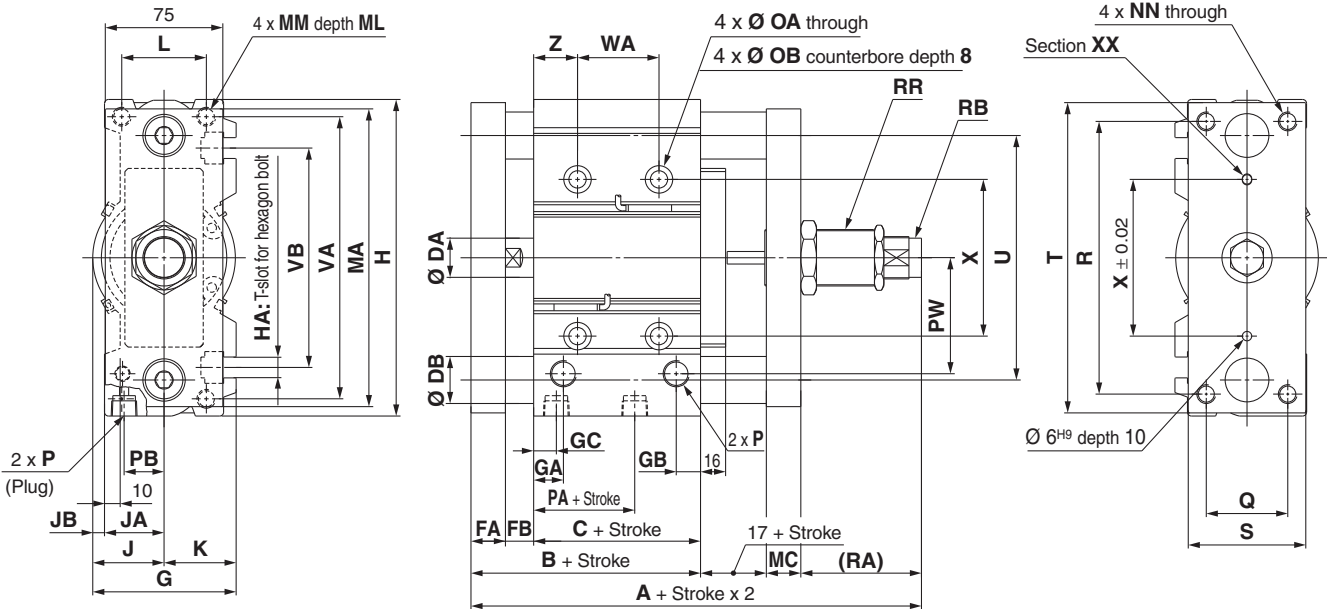

**Common Dimensions**

Bore size [mm]	Standard stroke [mm]	A	B	C	DA	DB		FA	FB	G	GA	GB	GC	H	HA	J	JA	JB	K	L	MA	MC
						Slide	Ball bushing															
80	25, 50, 75, 100, 125, 150, 175	212.5	96.5	56.5	25	30	25	22	18	91.5	19	15.5	14.5	202	M12	45.5	38	7.5	46	54	190	22
100	200, 250, 300, 350, 400	232	116	66	30	36	30	25	25	111.5	23	19	18	240	M14	55.5	45	10.5	56	62	228	25

Bore size [mm]	MM	ML	NN	OA	OB	P			PA	PB	PW	Q	R	RA	RB	RR	S	T	U	VA	VB
						—	N	TF													
80	M12 x 1.75	25	M12 x 1.75	10.6	17.5	Rc 3/8	NPT 3/8	G 3/8	14.5	25.5	74	52	174	77	RB2725	M36 x 1.5	75	198	156	180	140
100	M14 x 2.0	31	M14 x 2.0	12.5	20	Rc 3/8	NPT 3/8	G 3/8	17.5	32.5	89	64	210	74	RB2725	M36 x 1.5	90	236	188	210	166

Bore size [mm]	WA					WB					X	YY	YL	Z
	25 st or less	Over 25 st to 100 st	Over 100 st to 200 st	Over 200 st to 300 st	Over 300 st	25 st or less	Over 25 st to 100 st	Over 100 st to 200 st	Over 200 st to 300 st	Over 300 st				
80	28	52	128	200	300	42	54	92	128	178	100	M12 x 1.75	24	28
100	48	72	148	220	320	35	47	85	121	171	124	M14 x 2.0	28	11

\*: Rc, NPT or G ports selectable

Basic Type **MGP-Z**  
With Air Cushion **MGP-AZ**  
With End Lock **MGP**  
Heavy Duty Guide Rod Type **MGPS**  
Auto Switch

## 13 Bottom Mounting Type

Symbol  
**-XC82**

Since the guide rod does not protrude from the bottom at the retraction of the rod, relief holes for guide rods are not required.

### Applicable Series

Description	Model	Action
Standard type	MGPM-Z	Double acting

### How to Order

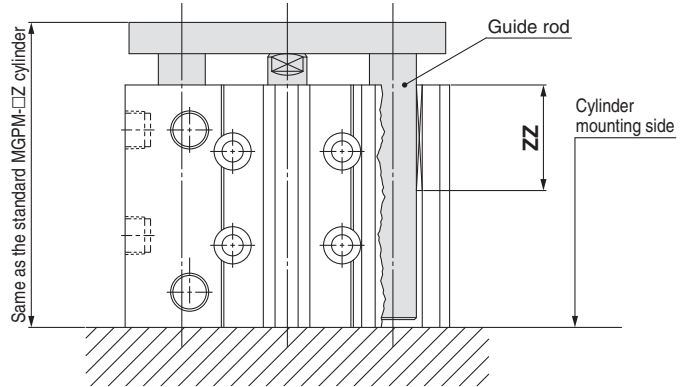
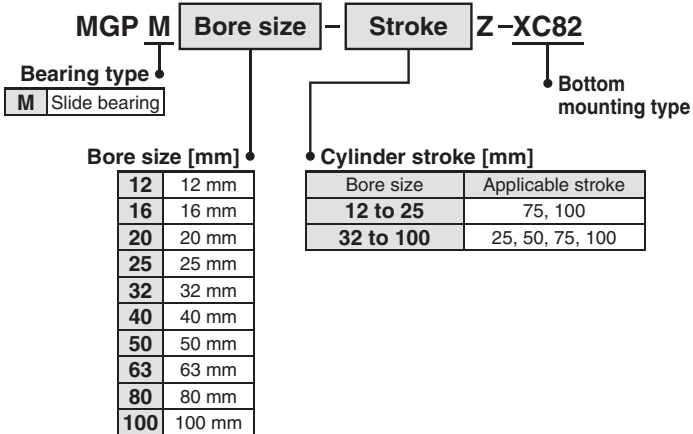

\*: The total length (ZZ) of the guide rod bushing is shorter than the standard products.

## 14 Grease for Food Processing Equipment

Symbol  
**-XC85**

Food grade grease (certified by NSF-H1) is used as lubricant.

### Applicable Series

Description	Model	Action
Standard type	MGPM-Z	Double acting
	MGPL-Z	Double acting
	MGPA-Z	Double acting
With air cushion	MGPM-AZ	Double acting
	MGPL-AZ	Double acting
	MGPA-AZ	Double acting
Heavy duty guide rod type	MGPS	Double acting

### Specifications

<b>Ambient temperature range</b>	0 °C to 60 °C
<b>Seals material</b>	Nitrile rubber
<b>Grease</b>	Grease for food
<b>Auto switch</b>	Mountable
<b>Dimensions</b>	Same as standard type
<b>Specifications other than above</b>	Same as standard type

### How to Order



### Warning

#### Precautions

Be aware that smoking cigarettes etc. after your hands have come into contact with the grease used in this cylinder can create a gas that is hazardous to humans.

#### Not installable zone

**Food zone** ..... An environment where food which will be sold as merchandize, directly touches the cylinder's components.

**Splash zone** ..... An environment where food which will not be sold as merchandize, directly touches the cylinder's components.

#### Installable zone

**Non-food zone**.... An environment where there is no contact with food.

\*: Avoid using this product in the food zone. (Refer to the figure on the right.)

\*: When the product is used in an area of liquid splash, or a water resistant function is required for the product, please consult with SMC.

\*: Operate without lubrication from a pneumatic system lubricator.

\*: Use the following grease pack for the maintenance work.

**GR-H-010** (Grease: 10 g)

\*: Please contact SMC for details about the maintenance intervals for this cylinder, which differ from those of the standard cylinder.

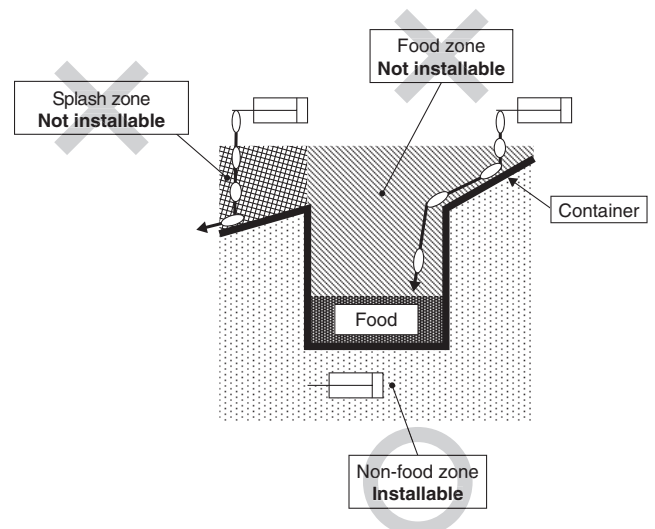

**15 Spatter Resistant Coil Scraper, Lube-retainer, Grease for Welding (Rod parts: Stainless steel 304)**

Symbol  
**-XC88**

Reduces spatter adhesion and improves durability by the use of the coil scraper, Lube-retainer and grease for welding.

**Applicable Series**

Description	Model	Action
Standard type	MGPM-Z	Double acting

**Specifications**

<b>Bore size</b>		Ø 32 to Ø 100
<b>Piston rod, Guide rod</b>		Stainless steel 304 (With hard chrome plated)
<b>Scraper</b>		With coil scraper, With Lube-retainer
<b>Minimum operating pressure</b>	On single side	0.12 MPa
	On both sides	0.14 MPa
<b>Grease</b>		Grease for welding
<b>Other specifications</b>		Same as standard type

**How to Order**

**MGPM** Standard model no. **-XC88**  

Spatter resistant coil scraper, Lube-retainer, Grease for welding (Rod parts: Stainless steel 304)

Scraper

—	With scraper on single side
W	With scrapers on both sides

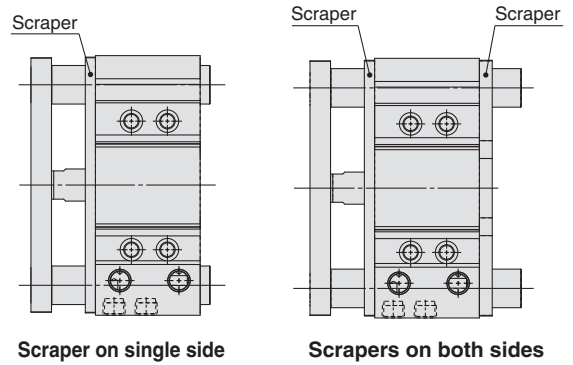

**Dimensions** (Dimensions other than below are the same as standard type.)

**Scraper on single side**

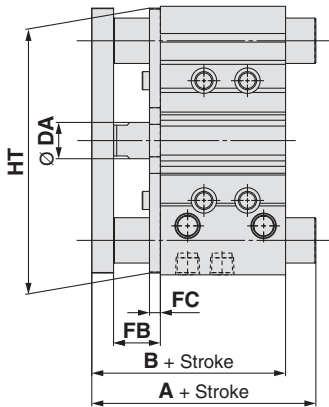

Bore size [mm]	A			B	DA	FB	FC	HT
	50 st or less	Over 50 st to 200 st	Over 200 st					
<b>32</b>	85	103.5	139.5	69.5	(14)	22	6	110
<b>40</b>	85	103.5	139.5	76	(14)	22	6	118
<b>50</b>	98.5	119.5	160.5	82	20	26	6	146
<b>63</b>	98.5	119.5	160.5	87	20	26	6	160
<b>80</b>	114.5	141.5	190.5	106.5	25	34	8	199
<b>100</b>	136.5	161.5	200.5	126	30	41	9	236

The dimensions in ( ) are the same as standard type.

**Scrapers on both sides**

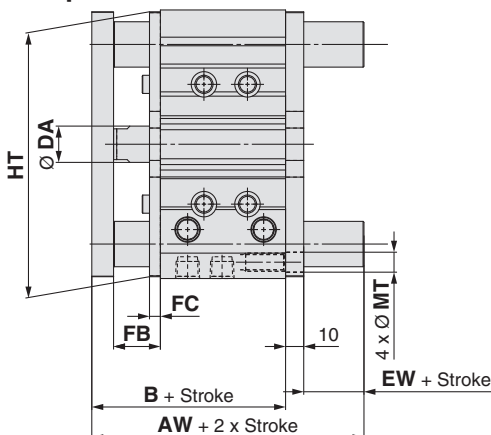

Bore size	AW	B	DA	EW	FB	FC	HT	MT
<b>40</b>	89	76	(14)	3	22	6	118	8.5
<b>50</b>	95	82	20	3	26	6	146	11
<b>63</b>	100	87	20	3	26	6	160	11
<b>80</b>	120.5	106.5	25	4	34	8	199	14
<b>100</b>	143	126	30	7	41	9	236	16

The dimensions in ( ) are the same as standard type.

Basic Type  
**MGP-Z**

With Air Cushion  
**MGP-AZ**

With End Lock  
**MGP**

Heavy Duty Guide Rod Type  
**MGPS**

Auto Switch

Made to Order

## 16 Spatter Resistant Coil Scraper, Lube-retainer, Grease for Welding (Rod parts: S45C) Symbol -XC89

Reduces spatter adhesion and improves durability by the use of the coil scraper, Lube-retainer and grease for welding.

### Applicable Series

Description	Model	Action
Standard type	MGPM-Z	Double acting

### How to Order

MGPM Standard model no. - XC89 W

Spatter resistant coil scraper, Lube-retainer, Grease for welding (Rod parts: S45C)
 Scrapers on both sides

\*: The MGP-XC89 is equivalent to -XC91.

### Specifications

<b>Bore size</b>	Ø 32 to Ø 100
<b>Piston rod, Guide rod</b>	S45C (With hard chrome plated)
<b>Scraper</b>	With coil scraper, With Lube-retainer
<b>Minimum operating pressure</b>	0.14 MPa
<b>Grease</b>	Grease for welding
<b>Other specifications</b>	Same as standard type

### Dimensions (Dimensions other than below are the same as standard type.)

#### Scrapers on both sides

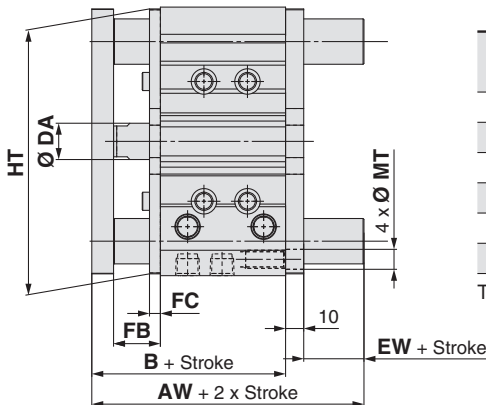

[mm]								
Bore size	AW	B	DA	EW	FB	FC	HT	MT
32	82.5	69.5	(14)	3	22	6	110	9
40	89	76	(14)	3	22	6	118	8.5
50	95	82	20	3	26	6	146	11
63	100	87	20	3	26	6	160	11
80	120.5	106.5	25	4	34	8	199	14
100	143	126	30	7	41	9	236	16

The dimensions in ( ) are the same as standard type.

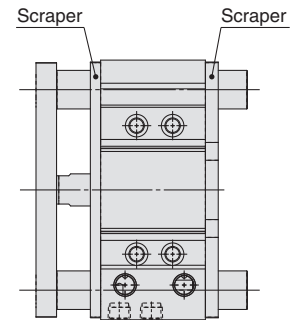

Scrapers on both sides

## 17 Spatter Resistant Coil Scraper, Grease for Welding (Rod parts: S45C) Symbol -XC91

With coil scraper and grease for welding

### Applicable Series

Description	Model	Action
Standard type	MGPM-Z	Double acting

### How to Order

MGPM Standard model no. - XC91  

Spatter resistant coil scraper, Grease for welding (Rod parts: S45C)
 Scraper

—	With scraper on single side
W	With scrapers on both sides

### Specifications

<b>Bore size</b>	Ø 32 to Ø 100
<b>Piston rod, Guide rod</b>	S45C (With hard chrome plated)
<b>Scraper</b>	With coil scraper
<b>Minimum operating pressure</b>	0.14 MPa
<b>Grease</b>	Grease for welding
<b>Other specifications</b>	Same as standard type

### Dimensions (Dimensions other than below are the same as standard type.)

#### Scrapers on both sides

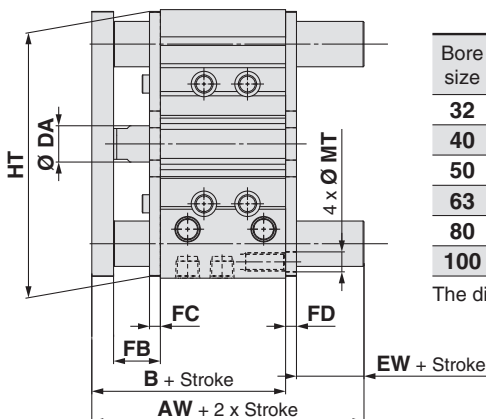

[mm]									
Bore size	AW	B	DA	EW	FB	FC	FD	HT	MT
32	82.5	69.5	(14)	7	22	6	6	110	9
40	89	76	(14)	7	22	6	6	118	8.5
50	95	82	20	7	26	6	6	146	11
63	100	87	20	7	26	6	6	160	11
80	120.5	106.5	25	8	34	8	6	199	14
100	143	126	30	8	41	9	9	236	16

The dimensions in ( ) are the same as standard type.

\*: The details of the scraper mounting are the same as XC88.



## 18 Dust Resistant Actuator

Symbol  
**-XC92**

Applicable for environments with flying micro-powder (20 to 30 μm or less) such as ceramic powder, toner powder, paper powder, and metallic powder (except weld spatter).

4 times stronger than the standard model

### How to Order

**MGPM** [Bore size] — [Stroke] — [Auto switch] [Suffix] — **XC92** [ ]

Bore size [mm]	Standard stroke
12, 16	10, 20, 30, 40, 50, 75, 100
20, 25	20, 30, 40, 50, 75, 100, 125, 150, 175, 200
32 to 100	25, 50, 75, 100, 125, 150, 175, 200

Dust resistant actuator

### Suffix

Symbol	Type	Drive unit	Guide unit	
			Rod end	Head end
—	With lube-retainers on one side	○	○	—
W	With lube-retainers on both sides	○	○	○

XC92	Bore size	Minimum operating pressure
	Ø 12, Ø 16	0.2 MPa
XC92W	Ø 20 to Ø 100	0.15 MPa
	Ø 12, Ø 16	0.25 MPa
XC92W	Ø 20 to Ø 100	0.2 MPa

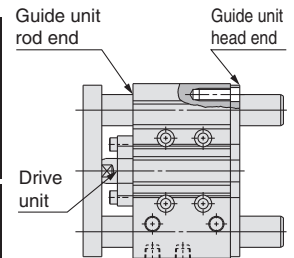

Specifications other than minimum operating pressure are the same as standard model.

### Dimensions (Dimensions other than below are the same as standard type.)

#### Series MGP

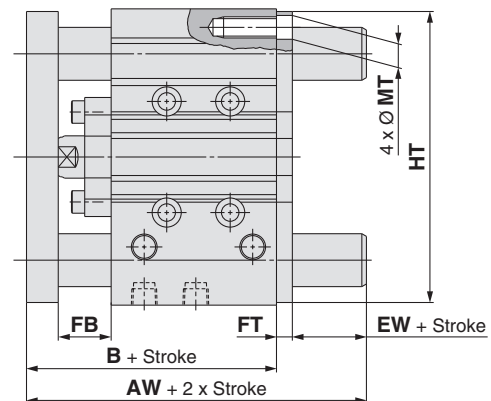
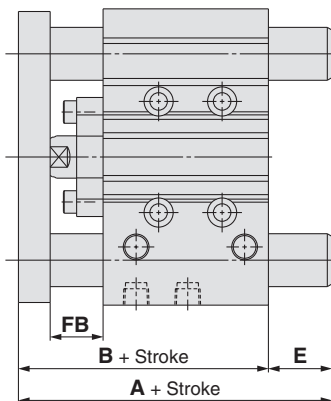

#### With Lube-retainers on One Side

Bore size [mm]	A		B	E		FB
	50 st or less	Over 50 st and 200 st or less*1		50 st or less	Over 50 st and 200 st or less*1	
	[mm]	[mm]		[mm]	[mm]	
12	52	70.5	52	0	18.5	15
16	56	74.5	56	0	18.5	15
20	63	94.5	63	0	31.5	16
25	63.5	95	63.5	0	31.5	16
32	97	112	69.5	27.5	42.5	20
40	97	112	76	21	36	20
50	106.5	128	82	24.5	46	22
63	106.5	128	87	19.5	41	22
80	125	152	106.5	18.5	45.5	28
100	147	172	126	21	46	35

\*1: The standard stroke for Ø 12 and Ø 16 is 100 st.

#### With Lube-retainers on Both Sides

Bore size [mm]	AW	B	EW	FB	FT	MT	HT
12	63	52	6	15	5	5	57
16	67	56	6	15	5	6	64
20	74	63	6	16	5	6	80
25	74.5	63.5	6	16	5	7	92
32	82.5	69.5	7	20	6	8.5	110
40	89	76	7	20	6	8.5	118
50	95	82	7	22	6	11	146
63	100	87	7	22	6	11	160
80	120.5	106.5	8	28	6	14	200
100	143	126	8	35	9	16	238

Basic Type  
**MGP-Z**

With Air Cushion  
**MGP-AZ**

With End Lock  
**MGP**

Heavy Duty Guide Rod Type  
**MGPS**

Auto Switch

Made to Order

## 19 Symmetrical Port Position

**-X144**

Ports are mounted symmetrically.

### Applicable Series

Description	Model	Action
Standard type	MGPM-Z	Double acting
	MGPL-Z	Double acting
	MGPA-Z	Double acting

### How to Order

MGP <sup>M</sup>L <sub>A</sub> Standard model no. -X144  
 Symmetrical port position ●

This makes it easy to remove and rotate piping when it is mounted on a wall where mounting space is limited.

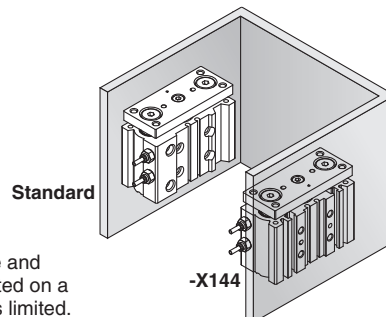

### Dimensions (Dimensions other than below are the same as standard type.)

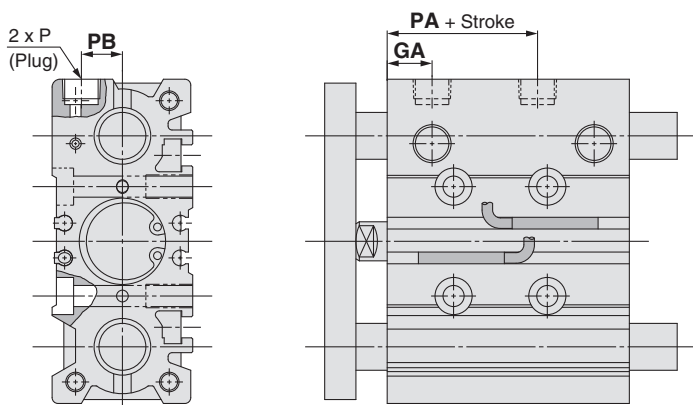

**MGPM, MGPL, MGPA Common Dimensions**

Bore size [mm]	GA	PA	PB
12	10	13	8
16	10.5	14.5	10
20	11.5	13.5	10.5
25	11.5	12.5	13.5
32	12	6.5	16
40	15	13	18
50	15	9	21.5
63	15.5	13	28
80	19	14.5	25.5
100	22.5	17.5	32.5

**20 Enlarged Plate and Body Gap Dimensions**

Symbol  
**-X471**

This specification increases the gap between the plate and body when the cylinder is retracted (Standard: 7 to 16 mm) to 28 to 31 mm. (Features a safety measure to protect fingers from being caught in the gap)

**Applicable series**

Description	Model	Action
Standard type	MGPM-Z	Double Acting

**Specifications: Same as standard type**

**How to Order**

**MGPM 32 - 100 Z - M9BW - X471**

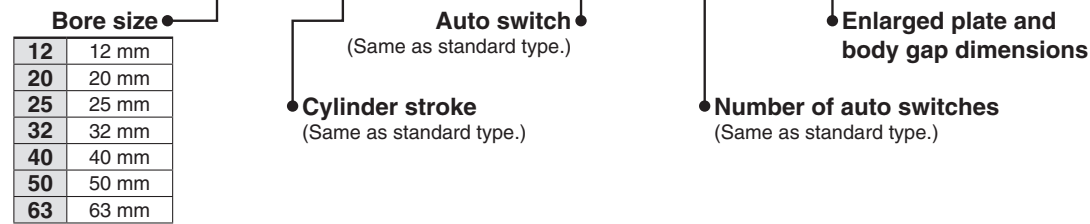

**Dimensions** (Dimensions other than below are the same as standard type.)

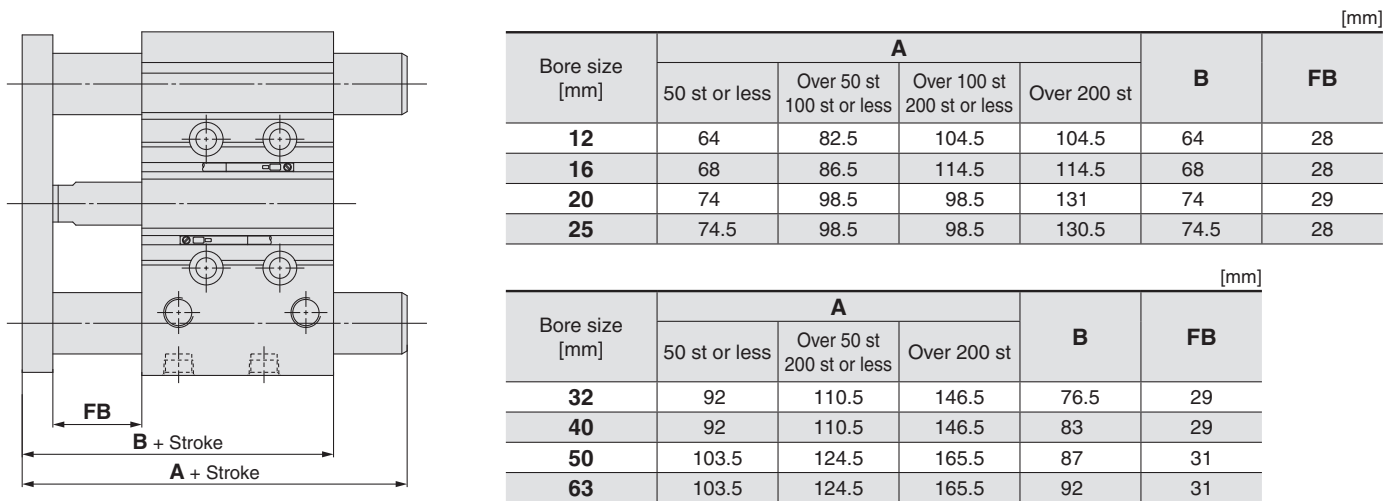

**21 Side Porting Type (Plug location changed)**

Symbol  
**-X867**

Ports on the top plugged in order to use the piping port on the side.

**Applicable Series**

Description	Model	Action
Standard type	MGPM-Z	Double acting
	MGPL-Z	Double acting
	MGPA-Z	Double acting
With air cushion	MGPM-AZ	Double acting
	MGPL-AZ	Double acting
	MGPA-ZA	Double acting
With end lock	MGPM	Double acting
	MGPL	Double acting
	MGPA	Double acting
Heavy duty guide rod type	MGPS	Double acting

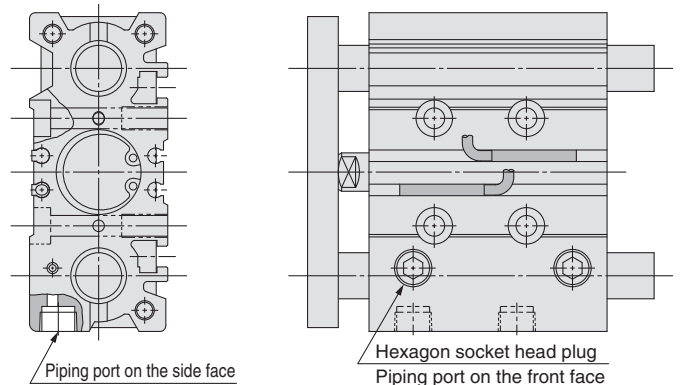

**How to Order**

**MGP<sup>M</sup><sub>L</sub><sup>A</sup> Standard model no. -X867**  
Side porting type (Plug location changed)

# Series MGP-□Z

## Made to Order

Please contact SMC for detailed dimensions, specifications and lead times.



### Replacement Parts: Seal Kit

\*: Seal kit part numbers other than those below are the same as those for the standard type.

\*: Since the seal kit does not include a grease pack, it should be ordered separately.

Bore size (mm)	MGP□R(NBR)/MGP□V(FKM) (Water resistant)		XB6 (Heat resistant cylinder -10 to 150°C)	XB13 (Low speed cylinder 5 to 50 mm/s)
	12	—	—	MGP12-Z-XB6-PS
16	—	—	MGP16-Z-XB6-PS	MGP16-Z-XB13-PS
20	MGP20R-Z-PS	MGP20V-Z-PS	MGP20-Z-XB6-PS	MGP20-Z-XB13-PS
25	MGP25R-Z-PS	MGP25V-Z-PS	MGP25-Z-XB6-PS	MGP25-Z-XB13-PS
32	MGP32R-Z-PS	MGP32V-Z-PS	MGP32-Z-XB6-PS	MGP32-Z-XB13-PS
40	MGP40R-Z-PS	MGP40V-Z-PS	MGP40-Z-XB6-PS	MGP40-Z-XB13-PS
50	MGP50R-Z-PS	MGP50V-Z-PS	MGP50-Z-XB6-PS	MGP50-Z-XB13-PS
63	MGP63R-Z-PS	MGP63V-Z-PS	MGP63-Z-XB6-PS	MGP63-Z-XB13-PS
80	MGP80R-Z-PS	MGP80V-Z-PS	MGP80-Z-XB6-PS	MGP80-Z-XB13-PS
100	MGP100R-Z-PS	MGP100V-Z-PS	MGP100-Z-XB6-PS	MGP100-Z-XB13-PS

Bore size (mm)	XC4 (With heavy duty scraper)	XC6 (Made of stainless steel)	XC8 (Adjustable stroke cylinder/Adjustable extension type)
	12	—	MGP12-Z-PS
16	—	MGP16-Z-PS	MGP16-Z-XC8-PS
20	MGP20-Z-PS	MGP20-Z-PS	MGP20-Z-XC8-PS
25	MGP25-Z-PS	MGP25-Z-PS	MGP25-Z-XC8-PS
32	MGP32-Z-PS	MGP32-Z-PS	MGP32-Z-XC8-PS
40	MGP40-Z-PS	MGP40-Z-PS	MGP40-Z-XC8-PS
50	MGP50-Z-XC4-PS	MGP50-Z-XC6-PS	MGP50-Z-XC8-PS
63	MGP63-Z-XC4-PS	MGP63-Z-XC6-PS	MGP63-Z-XC8-PS
80	MGP80-Z-XC4-PS	MGP80-Z-XC6-PS	MGP80-Z-XC8-PS
100	MGP100-Z-XC4-PS	MGP100-Z-XC6-PS	MGP100-Z-XC8-PS

Bore size (mm)	XC9 (Adjustable stroke cylinder/Adjustable retraction type)	XC22 (Fluororubber seal)	XC35 (With coil scraper)
	12	MGP12-Z-XC9-PS	MGP12-Z-XC22-PS
16	MGP16-Z-XC9-PS	MGP16-Z-XC22-PS	—
20	MGP20-Z-XC9-PS	MGP20-Z-XC22-PS	MGP20-Z-PS
25	MGP25-Z-XC9-PS	MGP25-Z-XC22-PS	MGP25-Z-PS
32	MGP32-Z-XC9-PS	MGP32-Z-XC22-PS	MGP32-Z-PS
40	MGP40-Z-XC9-PS	MGP40-Z-XC22-PS	MGP40-Z-PS
50	MGP50-Z-XC9-PS	MGP50-Z-XC22-PS	MGP50-Z-XC35-PS
63	MGP63-Z-XC9-PS	MGP63-Z-XC22-PS	MGP63-Z-XC35-PS
80	MGP80-Z-XC9-PS	MGP80-Z-XC22-PS	MGP80-Z-XC35-PS
100	MGP100-Z-XC9-PS	MGP100-Z-XC22-PS	MGP100-Z-XC35-PS

### Grease Pack Part No.

\*: Grease pack part numbers other than those below are the same as those for the standard type.

Symbol	Specifications	Grease pack part no.
25A-	Copper and zinc-free	GR-D-010 (10 g)
XB6	Heat resistant cylinder (-10 to 150°C)	GR-F-005 (5 g)
XB13	Low speed cylinder (5 to 50 mm/s)	GR-L-010 (10 g)
XC85	Grease for food processing equipment	GR-H-010 (10 g)



## Series MGP

# Specific Product Precautions 1

Be sure to read this before handling. Refer to the back cover for Safety Instructions. For Actuator and Auto Switch Precautions, refer to Handling Precautions for SMC Products and the Operation Manual on the SMC website, <http://www.smc.eu>

### Mounting

#### Warning

##### 1. Never place your hands or fingers between the plate and the body.

Be very careful to prevent your hands or fingers from getting caught in the gap between the cylinder body and the plate when air is applied.

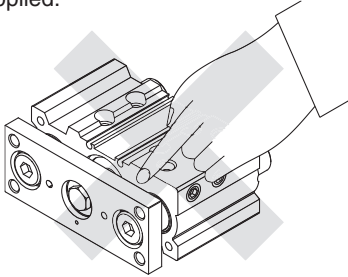

#### Caution

##### 1. Use cylinders within the piston speed range.

An orifice is set for this cylinder, but the piston speed may exceed the operating range if the speed controller is not used. If the cylinder is used outside the operating speed range, it may cause damage to the cylinder and shorten the service life. Adjust the speed by installing the speed controller and use the cylinder within the limited range.

##### 2. Pay attention to the operating speed when the product is mounted vertically.

When using the product in the vertical direction, if the load factor is large, the operating speed can be faster than the control speed of the speed controller (i.e. quick extension). In such cases, it is recommended to use a dual speed controller.

##### 3. Do not scratch or gouge the sliding portion of the piston rod and the guide rod.

Damaged seals etc. will result in leakage or malfunction.

##### 4. Do not dent or scratch the mounting surface of the body and the plate.

The flatness of the mounting surface may not be maintained, which would cause an increase in sliding resistance.

##### 5. Make sure that the cylinder mounting surface has a flatness of 0.05 mm or less.

If the flatness of the workpieces and brackets mounted on the plate is not appropriate, sliding resistance may increase. If it is difficult to maintain a flatness of 0.05 or less, put a thin shim ring (prepared by user) between the plate and workpiece mounting surface to prevent the sliding resistance from increasing.

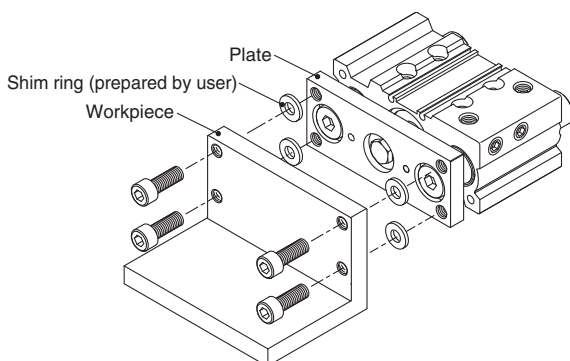

### Mounting

#### Caution

##### 6. Bottom of cylinder

The guide rods protrude from the bottom of the cylinder at the end of the retracting stroke, and therefore, in cases where the cylinder is to be bottom mounted, it is necessary to provide bypass ports in the mounting surface for the guide rods, as well as holes for the hexagon socket head cap screws which are used for mounting.

Moreover, in applications where impact occurs from a stopper etc., the mounting screws should be inserted to a depth of 2d or more.

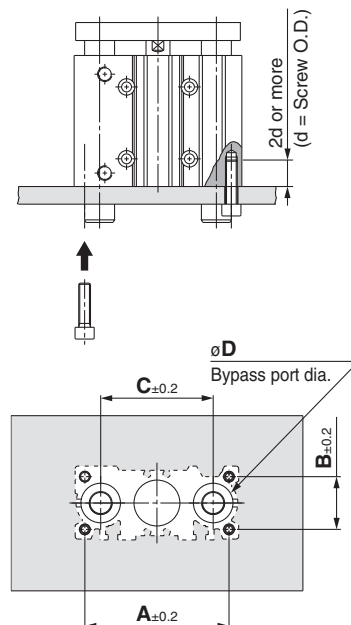

Bore size [mm]	A [mm]	B [mm]	C [mm]	D [mm]		Hexagon socket head cap screw
				MGPM	MGPL/A	
12*	50	18	41	10	8	M4 x 0.7
16	56	22	46	12	10	M5 x 0.8
20	72	24	54	14	12	M5 x 0.8
25	82	30	64	18	15	M6 x 1.0
32	98	34	78	22	18	M8 x 1.25
40	106	40	86	22	18	M8 x 1.25
50	130	46	110	27	22	M10 x 1.5
63	142	58	124	27	22	M10 x 1.5
80	180	54	156	33	28	M12 x 1.75
100	210	62	188	39	33	M14 x 2.0

\*: Air cushions are not available for bore size 12.



# Series MGP

## Specific Product Precautions 2

Be sure to read this before handling. Refer to the back cover for Safety Instructions. For Actuator and Auto Switch Precautions, refer to Handling Precautions for SMC Products and the Operation Manual on the SMC website, <http://www.smc.eu>

### Piping

#### ⚠ Caution

Depending on the operating conditions, piping port positions can be changed by using a plug.

##### 1. M5

After tightening by hand, tighten additional 1/6 to 1/4 rotation with a tightening tool.

##### 2. Tapered thread for Rc port (MGP) and NPT port (MGP□□TN)

Use the correct tightening torques listed below. Before tightening the plug, wrap pipe tape around it. Also, with regard to the sunk dimension of a plug (dimension "a" in the drawing), use the stipulated figures as a guide and confirm the air leakage before operation.

\* If tightening plugs on the top mounting port with more than the proper tightening torque, plugs will be screwed much deeply and air passage will be squeezed. Consequently, the cylinder speed will be restricted.

Connection thread (plug) size	Proper tightening torque [N·m]	a dimension
1/8	7 to 9	0.5 mm or less
1/4	12 to 14	1 mm or less
3/8	22 to 24	1 mm or less

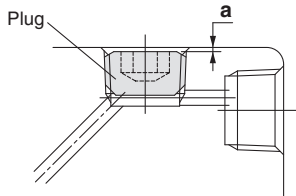

##### 3. Parallel pipe thread for G port (MGP□□TF)

Screw in the plug to the surface of the body (dimension "a" in the drawing) by checking visually instead of using the tightening torque shown in the table.

### Cushion

With air cushion

#### ⚠ Warning

##### 1. Do not open the cushion valve excessively.

Air leakage will occur if operated after opening by 4 rotations or more. Furthermore, a stopper mechanism is provided for the cushion valve, and it should not be forced open beyond that position. Be aware that the cushion valve may jump up from the cover when the air is supplied.

#### ⚠ Caution

##### 1. Be sure to use the cylinder after the air cushion has been adjusted appropriately.

First, fully close the cushion valve. Start the operation at the cylinder speed to be used with the load applied, and then open the cushion valve gradually to make the adjustment. The optimal adjustment is that the piston reaches its stroke end and the collision sound is minimised. If the cushion valve is used without adjusting the air cushion appropriately, this may cause damage to the retaining ring or piston.

Bore size [mm]	Applicable tool
16, 20, 25, 32, 40	JIS B4648 hexagon wrench key 1.5
50, 63, 80, 100	JIS B4648 hexagon wrench key 3

##### 2. Be sure to operate a cylinder equipped with air cushion to the end of the stroke.

If it is not operated to the end of the stroke, the effect of the air cushion will not be fully exhibited. Consequently, in cases where the stroke is regulated by an external stopper etc., caution must be exercised, as the air cushion may become completely ineffective.

##### 3. Do not open the cushion needle after rotating it numerous times in a row.

**Though uncommon, there are cases in which the cushion needle may leak air.**

The cushion needle should be adjusted by gradually opening it while checking the operation of the cylinder cushion.



# Series MGP

## Specific Product Precautions 3

Be sure to read this before handling. Refer to the back cover for Safety Instructions. For Actuator and Auto Switch Precautions, refer to Handling Precautions for SMC Products and the Operation Manual on the SMC website, <http://www.smc.eu>

### Allowable Kinetic Energy

#### ⚠ Caution

Work load and a maximum speed must be within the ranges shown in the graph below.

#### MGP with Rubber Bumper

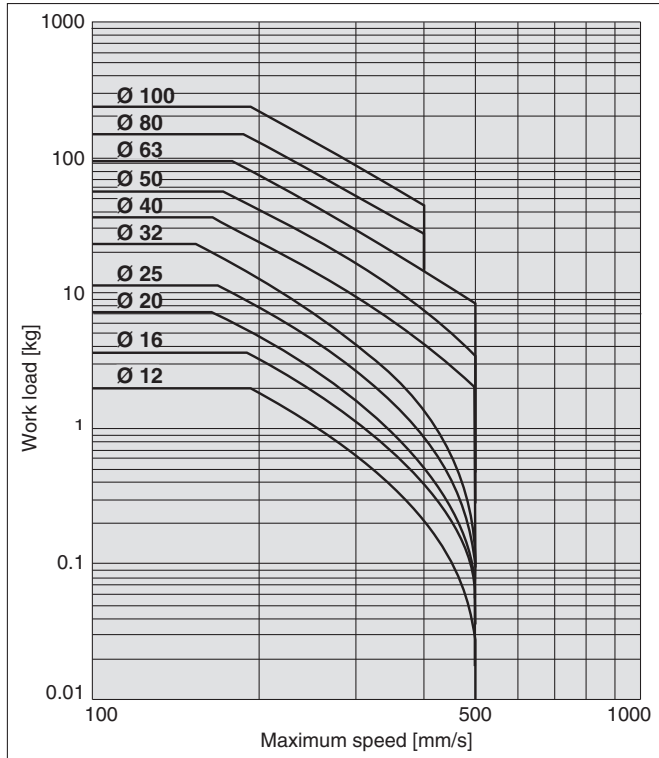

#### MGP with Air Cushion

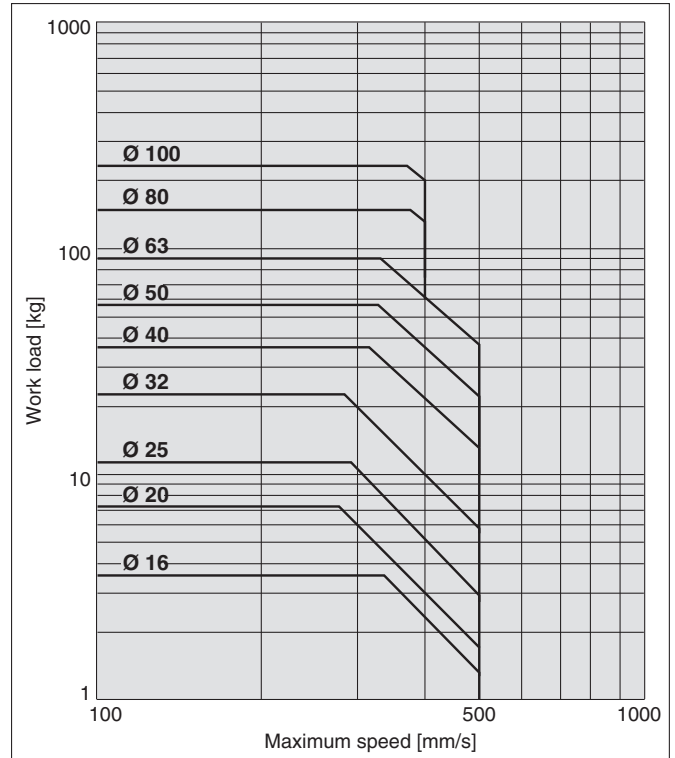

#### MGP without Cushion (MGP-□V (Water resistant), XB6, XC9, XC22)

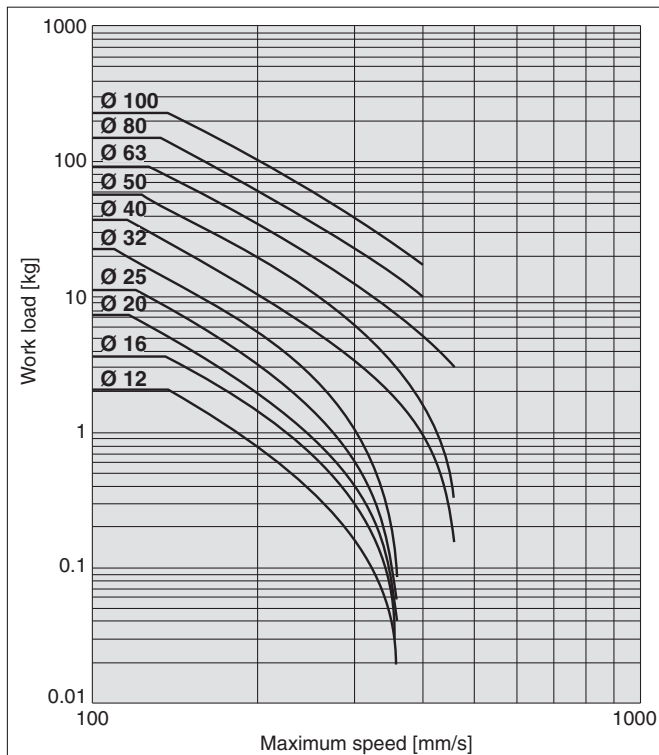







## Safety Instructions

These safety instructions are intended to prevent hazardous situations and/or equipment damage. These instructions indicate the level of potential hazard with the labels of “**Caution**,” “**Warning**” or “**Danger**.” They are all important notes for safety and must be followed in addition to International Standards (ISO/IEC)\*1), and other safety regulations.

-  **Caution:** **Caution** indicates a hazard with a low level of risk which, if not avoided, could result in minor or moderate injury.
-  **Warning:** **Warning** indicates a hazard with a medium level of risk which, if not avoided, could result in death or serious injury.
-  **Danger:** **Danger** indicates a hazard with a high level of risk which, if not avoided, will result in death or serious injury.

- \*1) ISO 4414: Pneumatic fluid power – General rules relating to systems.  
 ISO 4413: Hydraulic fluid power – General rules relating to systems.  
 IEC 60204-1: Safety of machinery – Electrical equipment of machines.  
 (Part 1: General requirements)  
 ISO 10218-1: Manipulating industrial robots - Safety.  
 etc.

### Warning

#### 1. The compatibility of the product is the responsibility of the person who designs the equipment or decides its specifications.

Since the product specified here is used under various operating conditions, its compatibility with specific equipment must be decided by the person who designs the equipment or decides its specifications based on necessary analysis and test results. The expected performance and safety assurance of the equipment will be the responsibility of the person who has determined its compatibility with the product. This person should also continuously review all specifications of the product referring to its latest catalogue information, with a view to giving due consideration to any possibility of equipment failure when configuring the equipment.

#### 2. Only personnel with appropriate training should operate machinery and equipment.

The product specified here may become unsafe if handled incorrectly. The assembly, operation and maintenance of machines or equipment including our products must be performed by an operator who is appropriately trained and experienced.

#### 3. Do not service or attempt to remove product and machinery/equipment until safety is confirmed.

1. The inspection and maintenance of machinery/equipment should only be performed after measures to prevent falling or runaway of the driven objects have been confirmed.
2. When the product is to be removed, confirm that the safety measures as mentioned above are implemented and the power from any appropriate source is cut, and read and understand the specific product precautions of all relevant products carefully.
3. Before machinery/equipment is restarted, take measures to prevent unexpected operation and malfunction.

#### 4. Contact SMC beforehand and take special consideration of safety measures if the product is to be used in any of the following conditions.

1. Conditions and environments outside of the given specifications, or use outdoors or in a place exposed to direct sunlight.
2. Installation on equipment in conjunction with atomic energy, railways, air navigation, space, shipping, vehicles, military, medical treatment, combustion and recreation, or equipment in contact with food and beverages, emergency stop circuits, clutch and brake circuits in press applications, safety equipment or other applications unsuitable for the standard specifications described in the product catalogue.
3. An application which could have negative effects on people, property, or animals requiring special safety analysis.
4. Use in an interlock circuit, which requires the provision of double interlock for possible failure by using a mechanical protective function, and periodical checks to confirm proper operation.

## Limited warranty and Disclaimer/ Compliance Requirements

The product used is subject to the following “Limited warranty and Disclaimer” and “Compliance Requirements”.

Read and accept them before using the product.

### Limited warranty and Disclaimer

1. The warranty period of the product is 1 year in service or 1.5 years after the product is delivered, whichever is first.\*2) Also, the product may have specified durability, running distance or replacement parts. Please consult your nearest sales branch.
2. For any failure or damage reported within the warranty period which is clearly our responsibility, a replacement product or necessary parts will be provided. This limited warranty applies only to our product independently, and not to any other damage incurred due to the failure of the product.
3. Prior to using SMC products, please read and understand the warranty terms and disclaimers noted in the specified catalogue for the particular products.

#### \*2) Vacuum pads are excluded from this 1 year warranty.

A vacuum pad is a consumable part, so it is warranted for a year after it is delivered. Also, even within the warranty period, the wear of a product due to the use of the vacuum pad or failure due to the deterioration of rubber material are not covered by the limited warranty.

### Compliance Requirements

1. The use of SMC products with production equipment for the manufacture of weapons of mass destruction (WMD) or any other weapon is strictly prohibited.
2. The exports of SMC products or technology from one country to another are governed by the relevant security laws and regulations of the countries involved in the transaction. Prior to the shipment of a SMC product to another country, assure that all local rules governing that export are known and followed.

### Caution

#### 1. The product is provided for use in manufacturing industries.

The product herein described is basically provided for peaceful use in manufacturing industries.

If considering using the product in other industries, consult SMC beforehand and exchange specifications or a contract if necessary.

If anything is unclear, contact your nearest sales branch.

### Caution

#### SMC products are not intended for use as instruments for legal metrology.

Measurement instruments that SMC manufactures or sells have not been qualified by type approval tests relevant to the metrology (measurement) laws of each country. Therefore, SMC products cannot be used for business or certification ordained by the metrology (measurement) laws of each country.

## Safety Instructions

Be sure to read “Handling Precautions for SMC Products” (M-E03-3) before using.

### SMC Corporation (Europe)

Austria	☎ +43 (0)2262622800	www.smc.at	office@smc.at	Lithuania	☎ +370 5 2308118	www.smclt.lt	info@smclt.lt
Belgium	☎ +32 (0)33551464	www.smc.be	info@smc.be	Netherlands	☎ +31 (0)205318888	www.smc.nl	post@smc.nl
Bulgaria	☎ +359 (0)2807670	www.smc.bg	office@smc.bg	Norway	☎ +47 67129020	www.smc-norge.no	post@smc-norge.no
Croatia	☎ +385 (0)13707288	www.smc.hr	office@smc.hr	Poland	☎ +48 222119600	www.smc.pl	office@smc.pl
Czech Republic	☎ +420 541424611	www.smc.cz	office@smc.cz	Portugal	☎ +351 214724500	www.smc.eu	apoioclientept@smc.smces.es
Denmark	☎ +45 70252900	www.smcdk.com	smc@smcdk.com	Romania	☎ +40 213205111	www.smcromania.ro	smcromania@smcromania.ro
Estonia	☎ +372 6510370	www.smc-pneumatics.ee	smc@smc-pneumatics.ee	Russia	☎ +7 8127185445	www.smc-pneumatik.ru	info@smc-pneumatik.ru
Finland	☎ +358 207513513	www.smc.fi	smc@smc.fi	Slovakia	☎ +421 (0)413213212	www.smc.sk	office@smc.sk
France	☎ +33 (0)164761000	www.smc-france.fr	info@smc-france.fr	Slovenia	☎ +386 (0)73885412	www.smc.si	office@smc.si
Germany	☎ +49 (0)61034020	www.smc.de	info@smc.de	Spain	☎ +34 945184100	www.smc.eu	post@smc.smces.es
Greece	☎ +30 210 2717265	www.smchellas.gr	sales@smchellas.gr	Sweden	☎ +46 (0)86031200	www.smc.nu	post@smc.nu
Hungary	☎ +36 23513000	www.smc.hu	office@smc.hu	Switzerland	☎ +41 (0)523963131	www.smc.ch	info@smc.ch
Ireland	☎ +353 (0)14039000	www.smc-pneumatics.ie	sales@smc-pneumatics.ie	Turkey	☎ +90 212 489 0 440	www.smc-pneumatik.com.tr	info@smc-pneumatik.com.tr
Italy	☎ +39 0292711	www.smccitalia.it	mailbox@smccitalia.it	UK	☎ +44 (0)845 121 5122	www.smc.uk	sales@smc.uk
Latvia	☎ +371 67817700	www.smc.lv	info@smc.lv				

SMC CORPORATION Akihbara UDX 15F, 4-14-1, Sotokanda, Chiyoda-ku, Tokyo 101-0021, JAPAN Phone: 03-5207-8249 FAX: 03-5298-5362