

# 59145 Flange Mount Sensor + 57145 Actuator

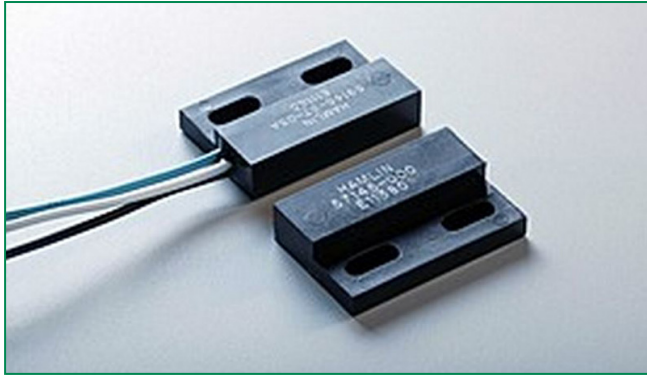

## Description

The 59145 is a flange mounting reed sensor 28.57mm x 19.05mm x 6.35mm (1.125" x 0.750" x 0.250") with a choice of normally open, normally open high voltage, normally closed or changeover contacts. It's case design enables screw or adhesive mounting and the wires exit from top right hand side. It is also available with left hand exit - see 59150 Series. It is capable of switching up to 265Vac/300Vdc at 10VA. The 59145 functions best with the matching actuator 57145-000.

**Note: The 57145 Actuator is sold separately.**

## Features

- Two-part magnetically operated proximity sensor
- Customer defined sensitivity option
- Choice of cable and connector

## Benefits

- Hermetically sealed, magnetically operated contacts continue to operate long after optical and other technologies fail due to contamination
- No standby power requirement
- Operates through non-ferrous materials such as wood, plastic or aluminium
- Simple installation and adjustment

## Agency Approvals

Agency	Agency File Number
	E61760

Note: Contact Littelfuse for specific agency approval ratings.

## Dimensions

Dimensions in mm (inch)

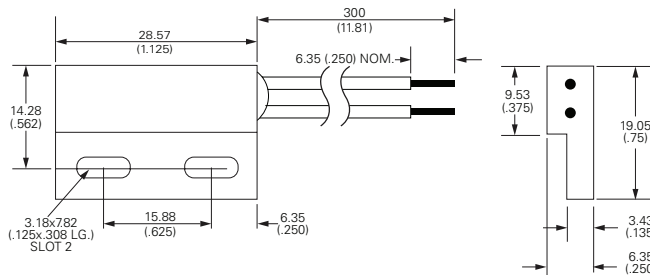
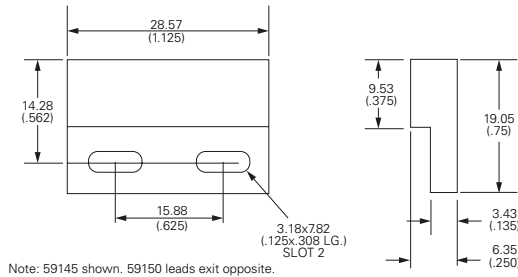

## Applications

- Position and limit sensing
- Security system switch
- Linear actuators
- Door switch

Schematics	Switch Type
	1 and 2
	3
	4

### 59145 Flange Mount Sensor + 57145 Actuator

#### Electrical Ratings

Contact Type			Normally Open	Normally Open High Voltage	Change Over	Normally Closed
Switch Type			1	2	3	4
Contact Rating <sup>1</sup>		VA/Watt - max.	10	10	5	5
Voltage <sup>4</sup>	Switching <sup>2</sup>	Vdc - max.	200	300	175	175
		Vac - max.	140	265	120	120
	Breakdown <sup>3</sup>	Vdc - min.	250	400	200	200
Current <sup>4</sup>	Switching <sup>2</sup>	Adc - max.	0.5	0.4	0.25	0.25
		Aac - max.	0.35	0.30	0.18	0.18
	Carry	Adc - max.	1.2	1.4	1.5	1.5
Resistance <sup>5</sup>	Contact, Initial Insulation	Ω - max.	0.2	0.2	0.2	0.2
		Ω - min.	10 <sup>10</sup>	10 <sup>10</sup>	10 <sup>9</sup>	10 <sup>9</sup>
Capacitance	Contact	pF - typ.	0.3	0.2	0.3	0.3
Temperature	Operating	°C	-40 to +105	-20 to +105	-40 to +105	-40 to +105

#### Product Characteristics

Operate Time <sup>6</sup>		ms - max.	1.0	1.0	3.0	3.0
Release Time <sup>6</sup>		ms - max.	1.0	1.0	3.0	3.0
Shock <sup>7</sup>	11ms ½ sine	G - max.	100	100	50	50
Vibration <sup>7</sup>	50-2000 Hz	G - max.	30	30	30	30

Notes:

- Contact rating - Product of the switching voltage and current should never exceed the wattage rating. Contact Littelfuse for additional load/life information.
- When switching inductive and/or capacitive loads, the effects of transient voltages and/or currents should be considered. Refer to Application Notes AN108A and AN107 for details.
- Breakdown Voltage - per MIL-STD-202, Method 301.
- Electrical Load Life Expectancy - Contact Littelfuse with voltage, current values along with type of load.
- This resistance value is for 11.81mm wire length. Resistance changes when wire lengthens.
- Operate (including bounce)/Release Time - per EIA/NARM RS-421-A, diode suppressed coil (Coil II).
- Shock and Vibration - per EIA/NARM RS-421-A and MIL-STD-202.
- For custom modifications to the wire length or size, or adding a special connector, please contact Littelfuse.

#### Sensitivity Options (Using 57145 Actuator)

Select Option		S		T		U		V	
Switch Type	Pull-In AT Range	Activate Distance - D mm (inch) Average	Pull-In AT Range	Activate Distance - D mm (inch) Average	Pull-In AT Range	Activate Distance - D mm (inch) Average	Pull-In AT Range	Activate Distance - D mm (inch) Average	
1	Normally Open	12-18	13.5 (.531)	17-23	11.2 (.441)	22-28	9.8 (.385)	27-33	9.0 (.357)
2	High Voltage	--	--	17-23	11.2 (.441)	22-28	9.8 (.385)	27-33	9.0 (.357)
3	Change Over	15-20	11.0 (.433)	20-25	9.2 (.362)	25-30	8.5 (.335)	--	--
4	Normally Closed	15-20	11.0 (.433)	20-25	9.2 (.362)	25-30	8.5 (.335)	--	--

Note:

- Pull-In AT Range: These AT values are the bare reed switch AT before modification.
- The activation distance is average value on the final sensor assembly.

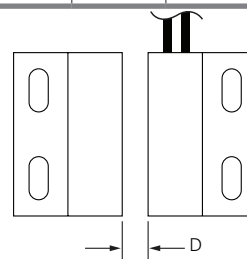

## 59145 Flange Mount Sensor + 57145 Actuator

### Cable Length Specification

Cable Type: 24 AWG 7/32 PVC 105°C UL1430/UL1569	
Select Option	Cable Length mm (inch)
02	300 (11.81)

### Termination Specification

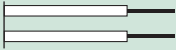
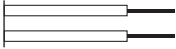
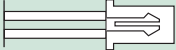
Termination Options		
Select Option	Description (Two-wire versions illustrated)	
A	Tinned leads (6.4±0.76)mm	
F	Untinned leads (6.4±0.76)mm	
E	JST type XHP 2.5mm pitch	

### Part Numbering System

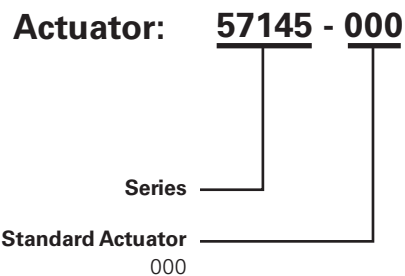
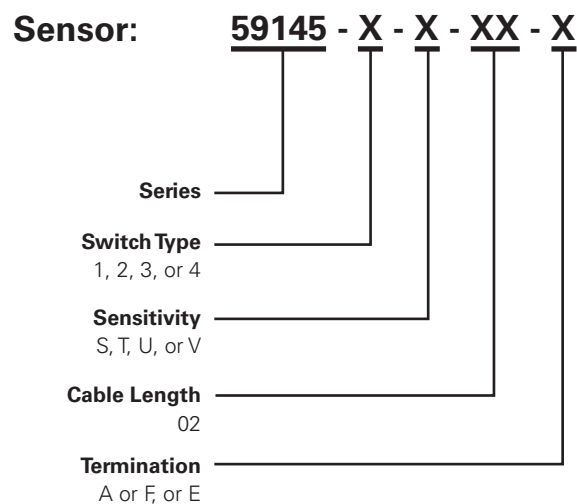

Note: The 57145 Actuator is sold separately.

### Packaging

Packaging Option	Packaging Specification	Quantity	Quantity & Packaging Code	Taping Width
Bulk	Bulk	500	N/A	N/A