

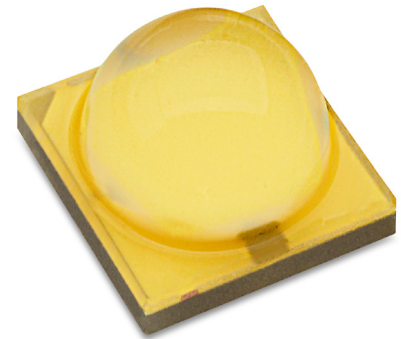

LUXEON V

Unmatched flux density with the lowest thermal resistance enabling never before possible form factors

LUXEON V is a Chip Scale Package (CSP) based high power emitter designed to deliver maximum flux in a compact 4.0mm x 4.0mm footprint. LUXEON V offers a unique combination of high efficacy at high drive current with extremely low thermal resistance and optimized radiation pattern to support next generation fixture designs. Building on the strengths of Lumileds Patterned Sapphire Substrate (PSS) CSP technology, LUXEON V offers the highest drive current capability in its class.



FEATURES AND BENEFITS

- Over 1700 lumens from a single, compact source
- Low thermal resistance of 0.8 K/W enables more efficient thermal management—smaller heatsink, more compact fixtures
- High efficacy at high drive current provides design flexibility and supports high flux density fixtures
- Optimized radiation pattern delivers high intensity beams from smaller optics
- Uniform optical source supports directional applications and imaging optics

PRIMARY APPLICATIONS

- High Bay & Low Bay
- Outdoor
 - Stadium and Area Lighting
- Specialty
 - Torch
 - Other Portables
- Spotlights

Table of Contents

General Product Information	2
Product Test Conditions	2
Part Number Nomenclature	2
Lumen Maintenance	2
Environmental Compliance	2
Performance Characteristics	3
Product Selection Guide	3
Optical Characteristics	3
Electrical and Thermal Characteristics	4
Absolute Maximum Ratings	4
Operating Conditions	4
Characteristic Curves	5
Spectral Power Distribution Characteristics	5
Light Output Characteristics	5
Forward Current Characteristics	6
Radiation Pattern Characteristics	7
Product Bin and Labeling Definitions	8
Decoding Product Bin Labeling	8
Luminous Flux Bins	8
Color Bin Definitions	9
Forward Voltage Bins	10
Mechanical Dimensions	10
Reflow Soldering Guidelines	11
JEDEC Moisture Sensitivity	11
Solder Pad Design	12
Packaging Information	13
Pocket Tape Dimensions	13
Reel Dimensions	13

General Product Information

Product Test Conditions

LUXEON V LEDs are tested and binned with a DC drive current of 1400mA at a junction temperature, T_j , of 85°C.

Part Number Nomenclature

Part numbers for LUXEON V follow the convention below:

L 1 V 1 – **A A B B 0 3 V C 0 D D D D**

Where:

- A A** – designates nominal ANSI CCT (27=2700K, 30=3000K, 40=4000K, 50=5000K, 57=5700K, 65=6500K)
- B B** – designates CRI (70=70CRI minimum, 7T=70CRI typical)
- C** – designates SDCM (3=3-step MacAdam ellipse, 5=5-step MacAdam ellipse, 7=7-step MacAdam ellipse)
- D D D D** – designates minimum luminous flux (optional)

Therefore, the following part number is used for a LUXEON V, 5-step MacAdam ellipse, 4000K 70CRI:

L 1 V 1 – **4 0 7 0 0 3 V 5 0 0 0 0 0**

Lumen Maintenance

Please contact your local Sales Representative or Lumileds Technical Solutions Manager for more information about the long-term performance of this product.

Environmental Compliance

Lumileds LLC is committed to providing environmentally friendly products to the solid-state lighting market. LUXEON V is compliant to the European Union directives on the restriction of hazardous substances in electronic equipment, namely the RoHS Directive 2011/65/EU and REACH Regulation (EC) 1907/2006. Lumileds LLC will not intentionally add the following restricted materials to its products: lead, mercury, cadmium, hexavalent chromium, polybrominated biphenyls (PBB) or polybrominated diphenyl ethers (PBDE).

Performance Characteristics

Product Selection Guide

Table 1. Product performance of LUXEON V at 1400mA, $T_j=85^\circ\text{C}$.

NOMINAL CCT	CRI ^[1, 2]	LUMINOUS FLUX ^[1] (lm)		PART NUMBER ^[3]
		MINIMUM	TYPICAL	
3000K	70 minimum	480	545	L1V1-307003Vx00000
4000K	70 minimum	510	576	L1V1-407003Vx00000
5000K	70 minimum	510	580	L1V1-507003Vx00000
5700K	70 minimum	510	580	L1V1-577003Vx00000
6500K	70 minimum	510	580	L1V1-657003Vx00000
5700K	70 typical	510	580	L1V1-577T03Vx00000
6500K	70 typical	510	580	L1V1-657T03Vx00000

Notes for Table 1:

1. Lumileds maintains a tolerance of ± 2 on CRI and $\pm 6.5\%$ on luminous flux measurements.
2. Typical CRI is approximately 2 points higher for those parts with minimum 70CRI specified, but this is not guaranteed. Minimum CRI is 68.5 for parts with 70CRI typical.
3. x = 5 or 7 and defines the number of MacAdam ellipse steps.

Optical Characteristics

Table 2. Optical characteristics for LUXEON V at 1400mA, $T_j=85^\circ\text{C}$.

PART NUMBER	TYPICAL TOTAL INCLUDED ANGLE ^[1]	TYPICAL VIEWING ANGLE ^[2]
L1V1-xxxx03Vx0xxxx	150°	120°

Notes for Table 2:

1. Total angle at which 90% of total luminous flux is captured.
2. Viewing angle is the off axis angle from the LED centerline where the luminous intensity is $\frac{1}{2}$ of the peak value.

Electrical and Thermal Characteristics

Table 3. Electrical and thermal characteristics for LUXEON V at 1400mA, T_j=85°C.

PART NUMBER	FORWARD VOLTAGE ⁽¹⁾ (V _f)			TYPICAL TEMPERATURE COEFFICIENT OF FORWARD VOLTAGE ⁽²⁾ (mV/°C)	TYPICAL THERMAL RESISTANCE—JUNCTION TO SOLDER PAD (°C/W)
	MINIMUM	TYPICAL	MAXIMUM		
L1V1-xxxx03Vx0xxxx	2.65	2.84	3.2	-2	0.80

Notes for Table 3:

- 1. Lumileds maintains a tolerance of ±0.06V on forward voltage measurements.
- 2. Measured between 25°C and 85°C.

Absolute Maximum Ratings

Table 4. Absolute maximum ratings for LUXEON V.

PARAMETER	MAXIMUM PERFORMANCE
DC Forward Current ⁽¹⁾	4800mA
Peak Pulsed Forward Current ⁽¹⁾	4800mA
LED Junction Temperature ⁽¹⁾ (DC & Pulse)	135°C
ESD Sensitivity	≤8000V Human Body Model (HBM) Class 3B JS-001-2012 <400V Machine Model (MM) Class B JESD22-A115-B
Operating Case Temperature ⁽¹⁾	-40°C to 130°C at 1400mA
LED Storage Temperature	-40°C to 135°C
Soldering Temperature	JEDEC 020c 250°C
Allowable Reflow Cycles	3
Autoclave Conditions	121°C at 2 ATM 100% Relative Humidity for 96 Hours Maximum
Reverse Voltage (V _{reverse})	LUXEON LEDs are not designed to be driven in reverse bias

Notes for Table 4:

- 1. Proper current derating must be observed to maintain the junction temperature below the maximum allowable junction temperature, as shown in Figure 1.

Operating Conditions

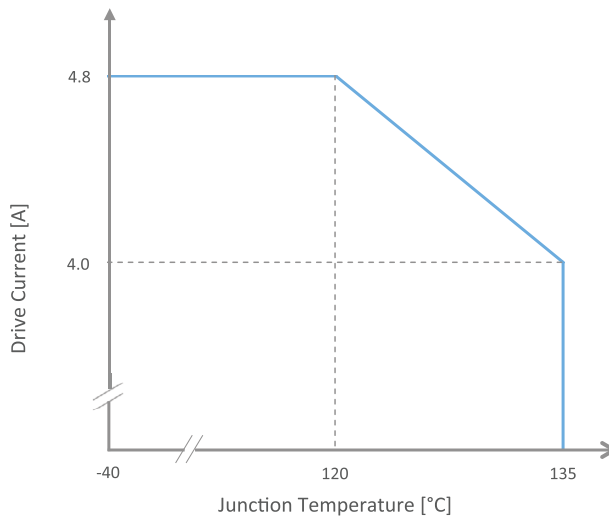

Figure 1. Maximum permissible operating conditions for LUXEON V.

Characteristic Curves

Spectral Power Distribution Characteristics

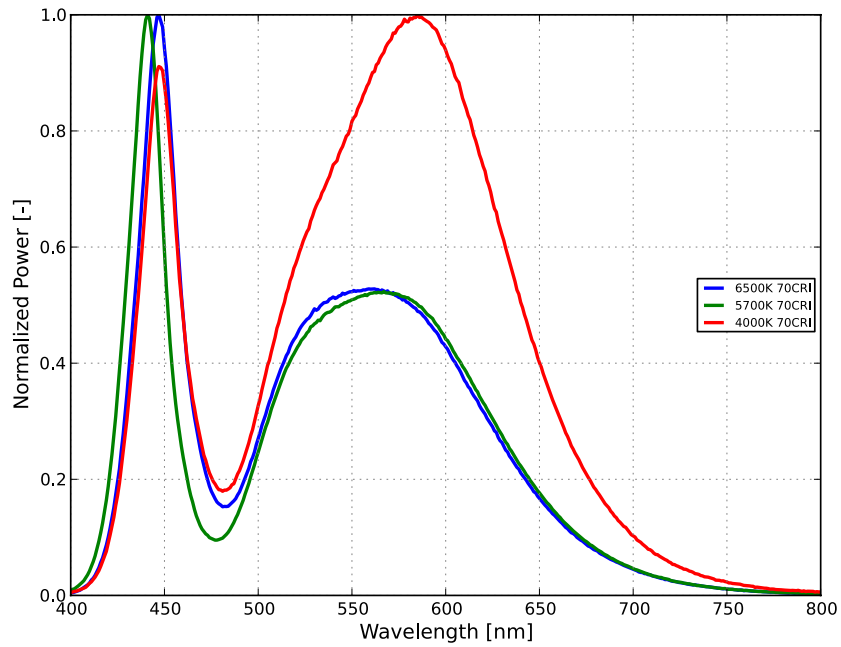

Figure 2. Typical normalized power vs. wavelength for LUXEON V at 1400mA, $T_j=85^{\circ}\text{C}$.

Light Output Characteristics

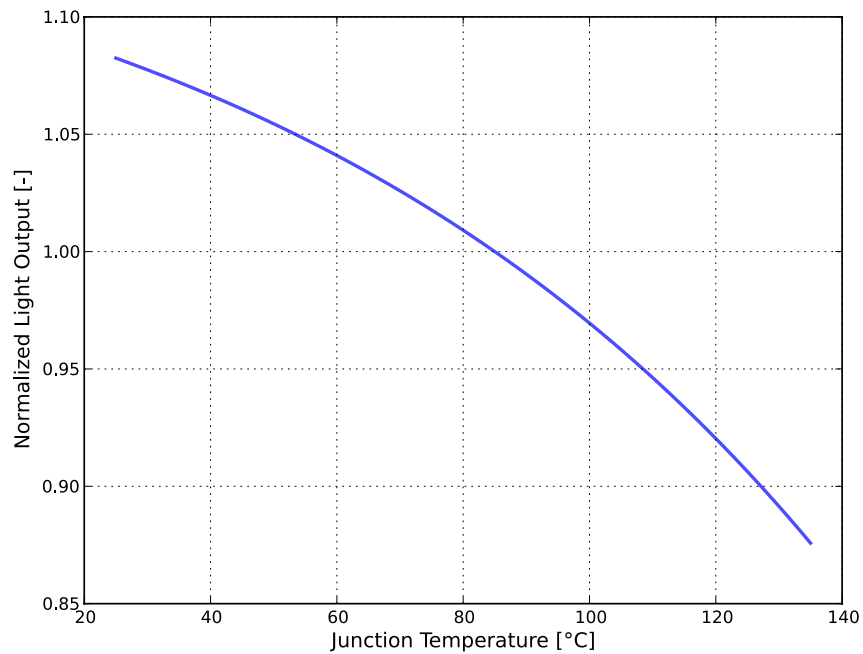

Figure 3. Typical normalized light output vs. junction temperature for LUXEON V at 1400mA, $T_j=85^{\circ}\text{C}$.

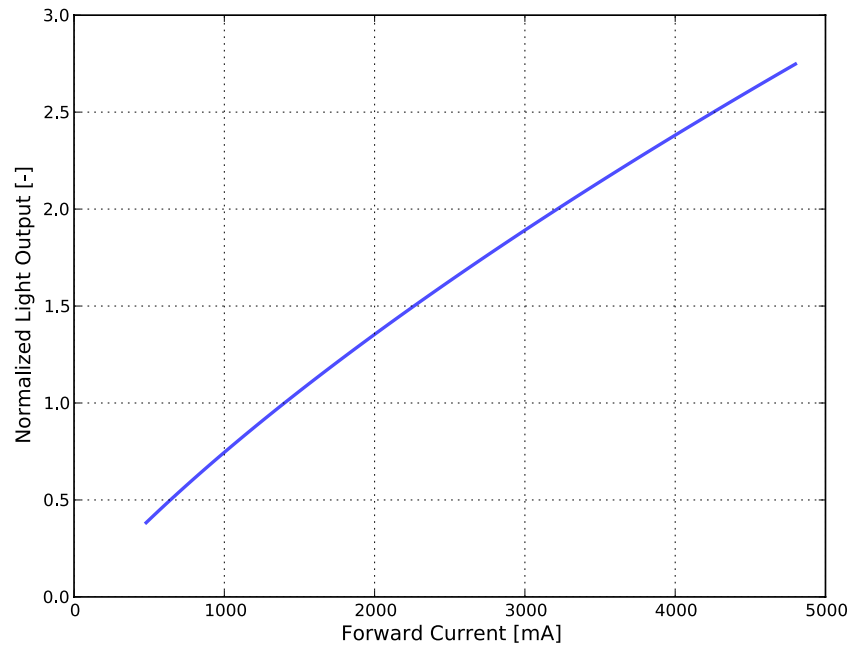

Figure 4. Typical normalized light output vs. forward current for LUXEON V at 1400mA, $T_j=85^\circ\text{C}$.

Forward Current Characteristics

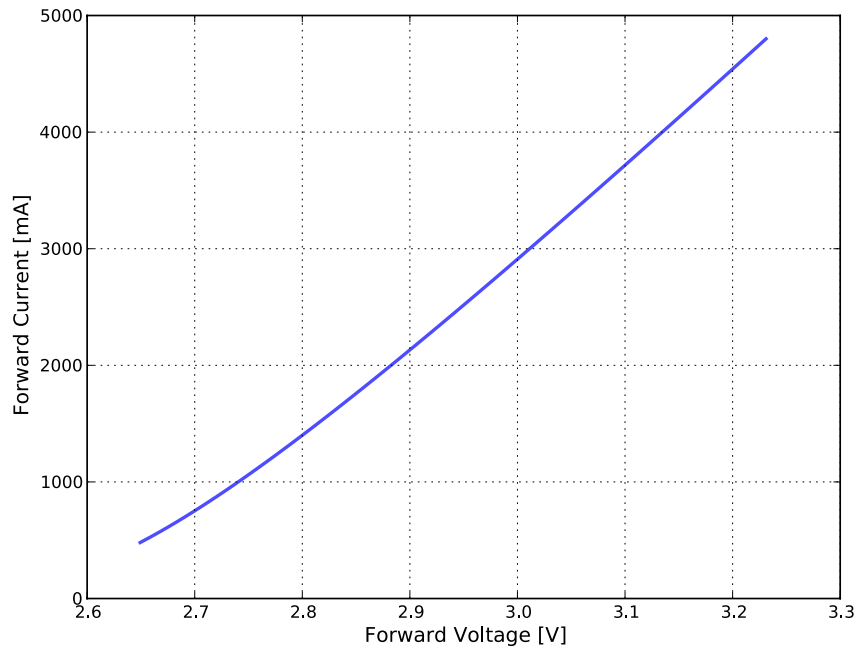

Figure 5. Typical forward current vs. forward voltage for LUXEON V at $T_j=85^\circ\text{C}$.

Radiation Pattern Characteristics

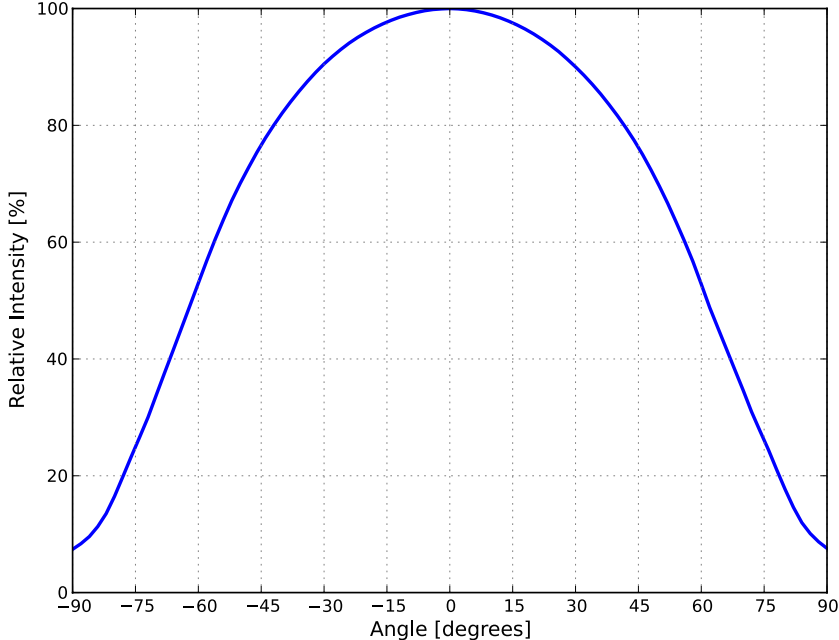

Figure 6. Typical radiation pattern for LUXEON V at 1400mA, $T_j=85^{\circ}\text{C}$.

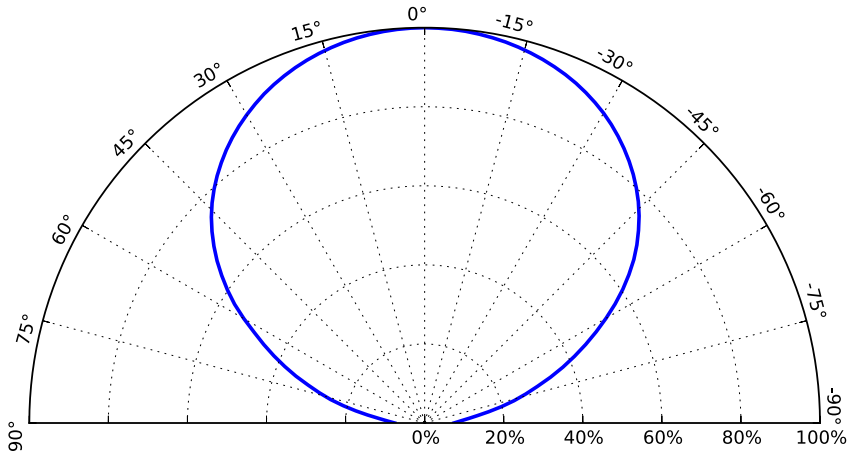

Figure 7. Typical polar radiation pattern for LUXEON V at 1400mA, $T_j=85^{\circ}\text{C}$.

Product Bin and Labeling Definitions

Decoding Product Bin Labeling

In the manufacturing of semiconductor products, there are variations in performance around the average values given in the technical datasheet. For this reason, Lumileds bins LED components for luminous flux or radiometric power, color point, peak or dominant wavelength and forward voltage.

LUXEON V LEDs are labeled using a 4-digit alphanumeric CAT code following the format below:

A B C D

Where:

- A** – designates luminous flux bin (example: U=510 to 540 lumens, X=600 to 630 lumens)
- B C** – designates color bin (example: 13, 5A, 5B, 5C, 5D, 7A, 7B, 7C, 7D)
- D** – designates forward voltage bin (example: G=2.85 to 3.00V, H=3.00 to 3.20V)

Therefore, a LUXEON V with a lumen range of 510 to 540 lm, color bin of 7A and a forward voltage range of 2.85 to 3.00V has the following CAT code:

U 7 A G

Luminous Flux Bins

Table 5 lists the standard luminous flux bins for LUXEON V emitters. Although several bins are outlined, product availability in a particular bin varies by production run and by product performance. Not all bins are available in all CCTs.

Table 5. Luminous flux bin definitions for LUXEON V, $T_j=85^\circ\text{C}$.

BIN	LUMINOUS FLUX ^[1] (lm)	
	MINIMUM	MAXIMUM
S	450	480
T	480	510
U	510	540
V	540	570
W	570	600
X	600	630
Y	630	660

Notes for Table 5:

1. Lumileds maintains a tolerance of $\pm 6.5\%$ on luminous flux measurements.

Color Bin Definitions

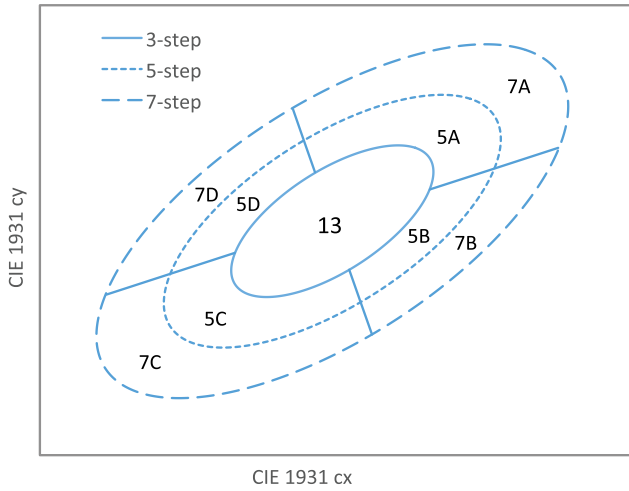

Figure 8. Color space definition for LUXEON V.

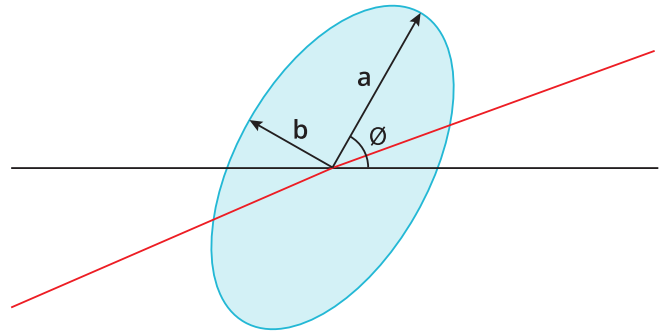

Figure 9. 3, 5 and 7-step MacAdam ellipse illustration for Table 6.

Table 6. 3, 5 and 7-step MacAdam ellipse color bin definitions for LUXEON V.

NOMINAL CCT	COLOR SPACE	CENTER POINT ^[1] (cx, cy)	MAJOR AXIS, a	MINOR AXIS, b	ELLIPSE ROTATION ANGLE, θ
2700K	Single 3-step MacAdam ellipse	(0.4578, 0.410)	0.008 100	0.004 200	53.70°
	Single 5-step MacAdam ellipse		0.013 500	0.007 000	
	Single 7-step MacAdam ellipse		0.018 900	0.009 800	
3000K	Single 3-step MacAdam ellipse	(0.4338, 0.4030)	0.008 340	0.004 080	53.22°
	Single 5-step MacAdam ellipse		0.013 900	0.006 800	
	Single 7-step MacAdam ellipse		0.019 460	0.009 520	
4000K	Single 3-step MacAdam ellipse	(0.3818, 0.3797)	0.009 390	0.004 020	53.72°
	Single 5-step MacAdam ellipse		0.015 650	0.006 700	
	Single 7-step MacAdam ellipse		0.021 910	0.009 380	
5000K	Single 3-step MacAdam ellipse	(0.3447, 0.3553)	0.008 220	0.003 540	59.62°
	Single 5-step MacAdam ellipse		0.013 700	0.005 900	
	Single 7-step MacAdam ellipse		0.019 180	0.008 260	
5700K	Single 3-step MacAdam ellipse	(0.3287, 0.3417)	0.007 455	0.003 195	59.09°
	Single 5-step MacAdam ellipse		0.012 425	0.005 325	
	Single 7-step MacAdam ellipse		0.017 395	0.007 455	
6500K	Single 3-step MacAdam ellipse	(0.3123, 0.3282)	0.006 690	0.002 850	58.57°
	Single 5-step MacAdam ellipse		0.011 150	0.004 750	
	Single 7-step MacAdam ellipse		0.015 610	0.006 650	

Notes for Table 6:

1. Lumileds maintains a tolerance of ±0.005 on x and y coordinates in the CIE 1931 color space.

Forward Voltage Bins

Table 8. Forward voltage bin definitions for LUXEON V.

BIN	FORWARD VOLTAGE ⁽¹⁾ (V _f)	
	MINIMUM	MAXIMUM
F	2.65	2.85
G	2.85	3.00
H	3.00	3.20

Notes for Table 8:

1. Lumileds maintains a tolerance of $\pm 0.06V$ on forward voltage measurements.

Mechanical Dimensions

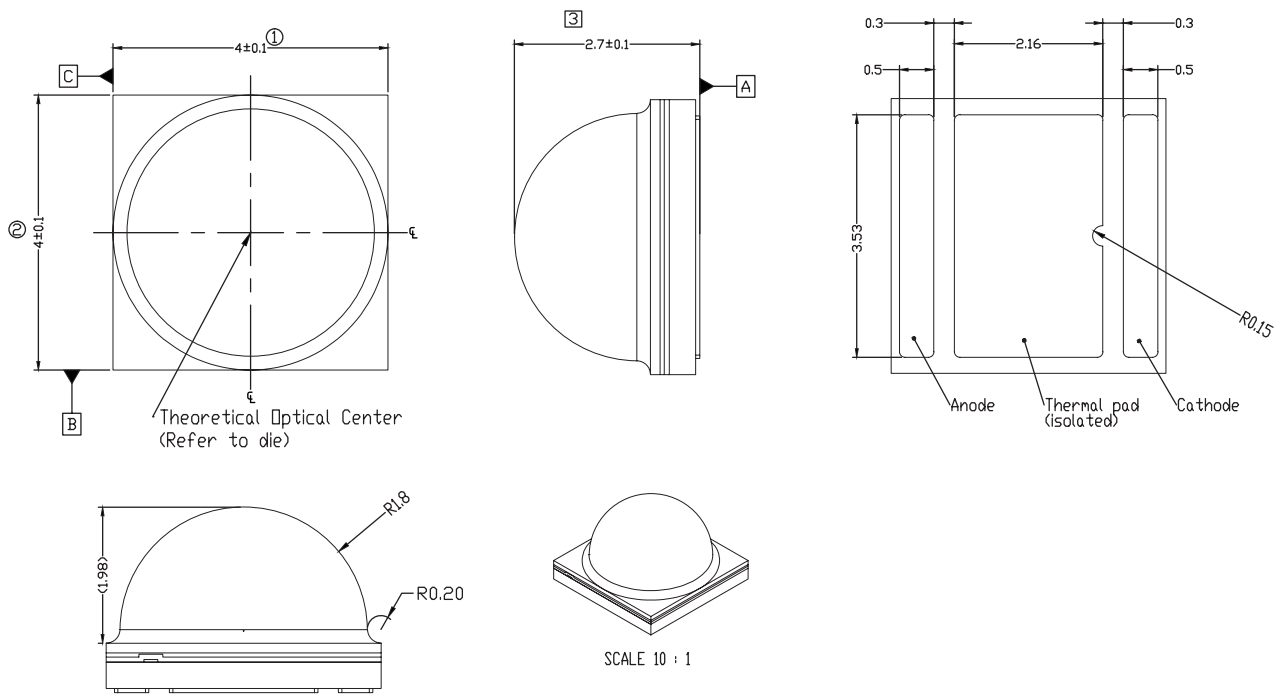

Figure 10. Mechanical dimensions for LUXEON V.

Notes for Figure 10:

1. Drawings are not to scale.
2. All dimensions are in millimeters.

Reflow Soldering Guidelines

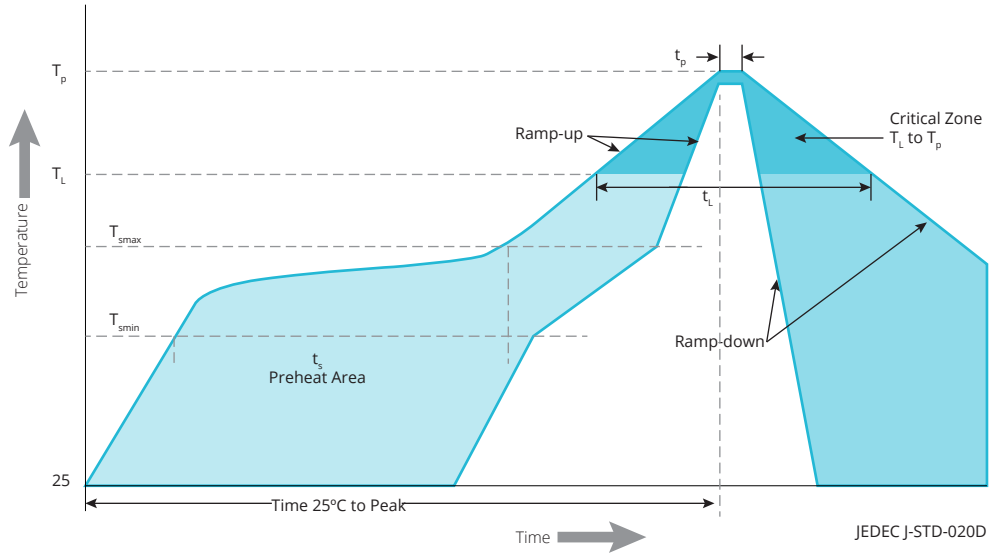

Figure 11. Visualization of the acceptable reflow temperature profile as specified in Table 8.

Table 8. Reflow profile characteristics for LUXEON V.

PROFILE FEATURE	LEAD-FREE ASSEMBLY
Preheat Minimum Temperature (T_{smin})	150°C
Preheat Maximum Temperature (T_{smax})	200°C
Preheat Time (t_{smin} to t_{smax})	60 to 180 seconds
Ramp-Up Rate (T_L to T_p)	3°C / second maximum
Liquidus Temperature (T_L)	217°C
Time Maintained Above Temperature T_L (t_t)	60 to 150 seconds
Peak / Classification Temperature (T_p)	250°C
Time Within 5°C of Actual Temperature (t_p)	20 to 40 seconds
Ramp-Down Rate (T_p to T_L)	6°C / second maximum
Time 25°C to Peak Temperature	8 minutes maximum

Notes for Table 8:

1. All temperatures refer to the application Printed Circuit Board (PCB), measured on the surface adjacent to the package body.

JEDEC Moisture Sensitivity

Table 9. Moisture sensitivity levels for LUXEON V.

LEVEL	FLOOR LIFE		SOAK REQUIREMENTS STANDARD	
	TIME	CONDITIONS	TIME	CONDITIONS
1	Unlimited	≤30°C / 85% RH	168 Hours +5 / -0	85°C / 85% RH

Solder Pad Design

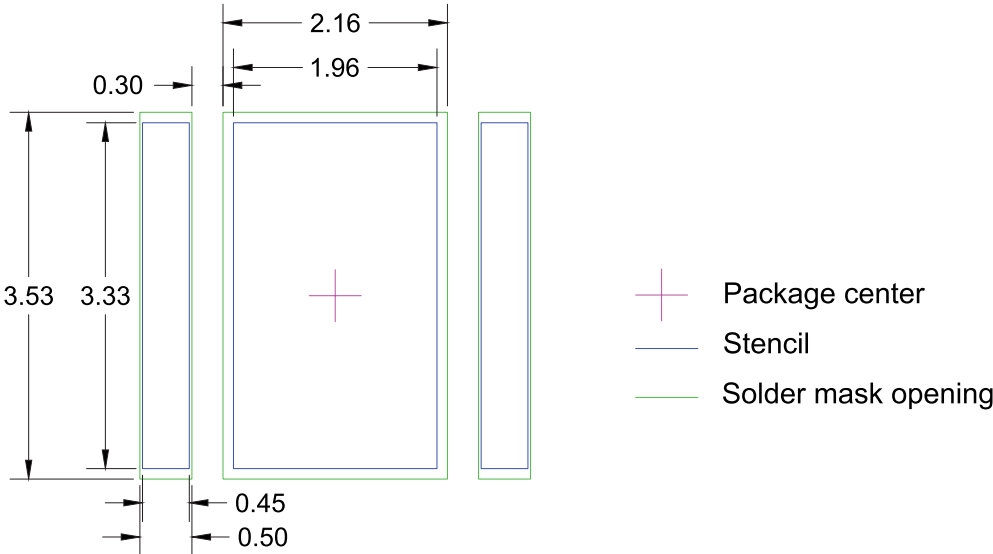

Figure 12. Recommended PCB solder pad layout for LUXEON V.

- Notes for Figure 12:
- 1. Drawings are not to scale.
 - 2. All dimensions are in millimeters.

Packaging Information

Pocket Tape Dimensions

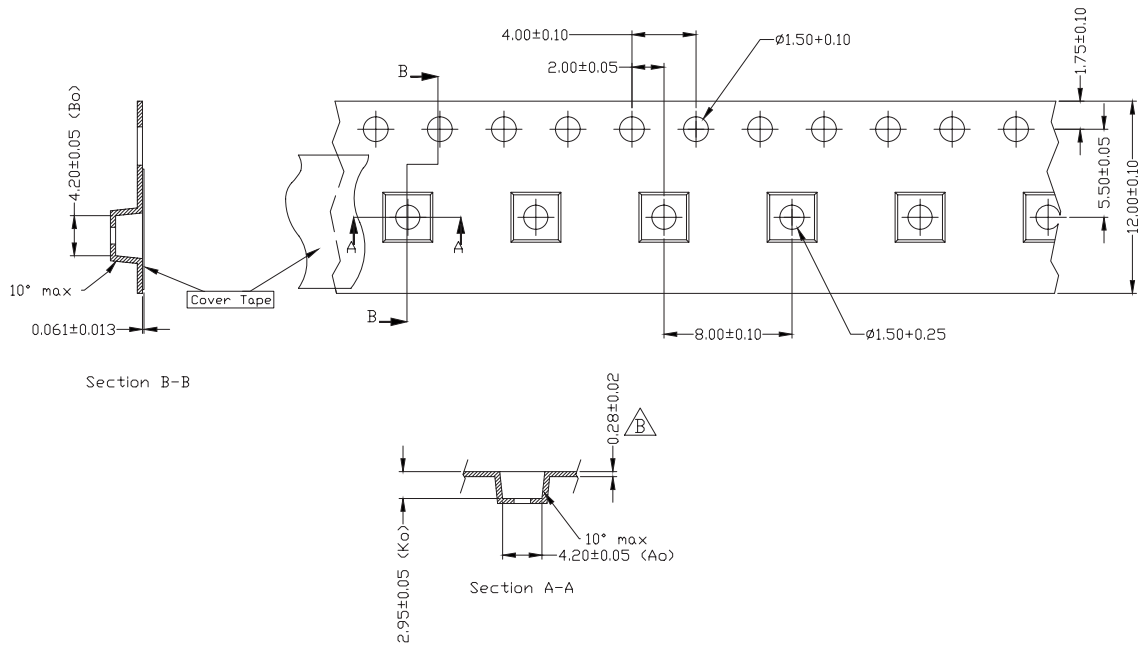

Figure 13. Pocket tape dimensions for LUXEON V.

Notes for Figure 13:

1. Drawings are not to scale.
2. All dimensions are in millimeters.

Reel Dimensions

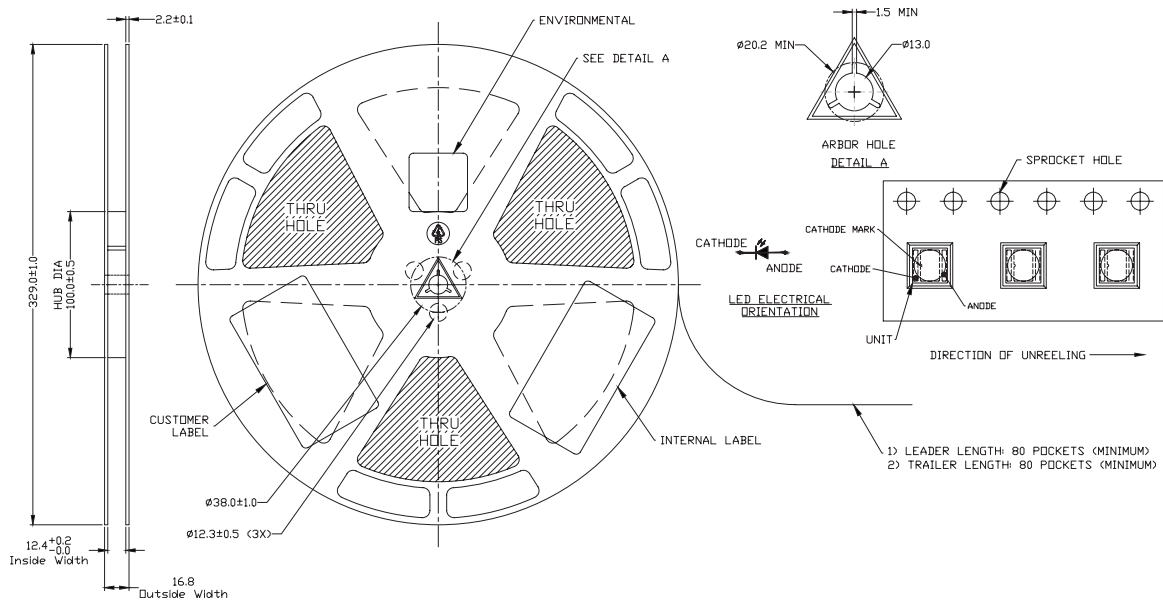

Figure 14. Reel dimensions for LUXEON V.

Notes for Figure 14:

1. Drawings are not to scale.
2. All dimensions are in millimeters.

About Lumileds

Companies developing automotive, mobile, IoT and illumination lighting applications need a partner who can collaborate with them to push the boundaries of light. With over 100 years of inventions and industry firsts, Lumileds is a global lighting solutions company that helps customers around the world deliver differentiated solutions to gain and maintain a competitive edge. As the inventor of Xenon technology, a pioneer in halogen lighting and the leader in high performance LEDs, Lumileds builds innovation, quality and reliability into its technology, products and every customer engagement. Together with its customers, Lumileds is making the world safer, better and more beautiful—with light.

To learn more about our lighting solutions, visit lumileds.com.

©2017 Lumileds Holding B.V. All rights reserved.
LUXEON is a registered trademark of the Lumileds Holding B.V. in the United States and other countries.
lumileds.com

Neither Lumileds Holding B.V. nor its affiliates shall be liable for any kind of loss of data or any other damages, direct, indirect or consequential, resulting from the use of the provided information and data. Although Lumileds Holding B.V. and/or its affiliates have attempted to provide the most accurate information and data, the materials and services information and data are provided “as is,” and neither Lumileds Holding B.V. nor its affiliates warrants or guarantees the contents and correctness of the provided information and data. Lumileds Holding B.V. and its affiliates reserve the right to make changes without notice. You as user agree to this disclaimer and user agreement with the download or use of the provided materials, information and data. A listing of Lumileds product/patent coverage may be accessed at lumileds.com/patents.