

Customer Part Number	MURATA Part Number	Inductance (nH)	Tolerance	Q (min.)	DC Resistance (Ω max.)	Self Resonant Frequency (MHz min.)	Rated Current (mA)	ESD Rank 1C:1kV
	LQG15HH3N9B02D	3.9	B: \pm 0.1nH C: \pm 0.2nH S: \pm 0.3nH	8	0.14	6000	750	1C
	LQG15HH3N9C02D							
	LQG15HH3N9S02D							
	LQG15HH4N3B02D	4.3						
	LQG15HH4N3C02D							
	LQG15HH4N3S02D							
	LQG15HH4N7B02D	4.7						
	LQG15HH4N7C02D							
	LQG15HH4N7S02D							
	LQG15HH5N1B02D	5.1						
	LQG15HH5N1C02D							
	LQG15HH5N1S02D							
	LQG15HH5N6B02D	5.6						
	LQG15HH5N6C02D							
	LQG15HH5N6S02D							
	LQG15HH6N2B02D	6.2						
	LQG15HH6N2C02D							
	LQG15HH6N2S02D							
	LQG15HH6N8G02D	6.8						
	LQG15HH6N8H02D							
	LQG15HH6N8J02D							
	LQG15HH7N5G02D	7.5						
	LQG15HH7N5H02D							
	LQG15HH7N5J02D							
	LQG15HH8N2G02D	8.2						
	LQG15HH8N2H02D							
	LQG15HH8N2J02D							
	LQG15HH9N1G02D	9.1						
	LQG15HH9N1H02D							
	LQG15HH9N1J02D							
	LQG15HH10NG02D	10						
	LQG15HH10NH02D							
	LQG15HH10NJ02D							
	LQG15HH12NG02D	12						
	LQG15HH12NH02D							
	LQG15HH12NJ02D							
	LQG15HH15NG02D	15						
	LQG15HH15NH02D							
	LQG15HH15NJ02D							
	LQG15HH18NG02D	18						
	LQG15HH18NH02D							
	LQG15HH18NJ02D							
	LQG15HH22NG02D	22						
	LQG15HH22NH02D							
	LQG15HH22NJ02D							
	LQG15HH27NG02D	27						
	LQG15HH27NH02D							
	LQG15HH27NJ02D							
	LQG15HH33NG02D	33						
	LQG15HH33NH02D							
	LQG15HH33NJ02D							
	LQG15HH39NG02D	39						
	LQG15HH39NH02D							
	LQG15HH39NJ02D							

Customer Part Number	MURATA Part Number	Inductance (nH)	Tolerance	Q (min.)	DC Resistance (Ω max.)	Self Resonant Frequency (MHz min.)	Rated Current (mA)	ESD Rank 1C:1kV																																			
		(*1)(refer to below comment)																																									
	LQG15HH47NG02D	47	G: \pm 2% H: \pm 3% J: \pm 5%	8	0.72	1000	300	1C																																			
	LQG15HH47NH02D																																										
	LQG15HH47NJ02D																																										
	LQG15HH56NG02D	56					G: \pm 2% H: \pm 3% J: \pm 5%		8	0.82	800	250	1C																														
	LQG15HH56NH02D																																										
	LQG15HH56NJ02D																																										
	LQG15HH68NG02D	68										G: \pm 2% H: \pm 3% J: \pm 5%		8	0.92	700	200	1C																									
	LQG15HH68NH02D																																										
	LQG15HH68NJ02D																																										
	LQG15HH82NG02D	82															G: \pm 2% H: \pm 3% J: \pm 5%		8	1.20	600	150	1C																				
	LQG15HH82NH02D																																										
	LQG15HH82NJ02D																																										
	LQG15HHR10G02D	100																				G: \pm 2% H: \pm 3% J: \pm 5%		8	1.25	550	120	1C															
	LQG15HHR10H02D																																										
	LQG15HHR10J02D																																										
	LQG15HHR12G02D	120																									G: \pm 2% H: \pm 3% J: \pm 5%		8	1.30	450	110	1C										
	LQG15HHR12H02D																																										
	LQG15HHR12J02D																																										
	LQG15HHR15G02D	150																														G: \pm 2% H: \pm 3% J: \pm 5%		8	2.99	500	120	1C					
	LQG15HHR15H02D																																										
	LQG15HHR15J02D																																										
	LQG15HHR18G02D	180																																			G: \pm 2% H: \pm 3% J: \pm 5%		8	3.38	400	110	1C
	LQG15HHR18H02D																																										
	LQG15HHR18J02D																																										
	LQG15HHR22G02D	220	G: \pm 2% H: \pm 3% J: \pm 5%	8	3.77	300		110																																		1C	
	LQG15HHR22H02D																																										
	LQG15HHR22J02D																																										
	LQG15HHR27G02D	270					G: \pm 2% H: \pm 3% J: \pm 5%	8	4.94	200	110		1C																														
	LQG15HHR27H02D																																										
	LQG15HHR27J02D																																										

(*1) Standard Testing Conditions

《Unless otherwise specified》

Temperature : Ordinary Temperature / 15°C to 35°C
 Humidity : Ordinary Humidity / 25%(RH) to 85%(RH)

《In case of doubt》

Temperature : 20°C \pm 2°C
 Humidity : 60%(RH) to 70%(RH)
 Atmospheric Pressure : 86kPa to 106 kPa

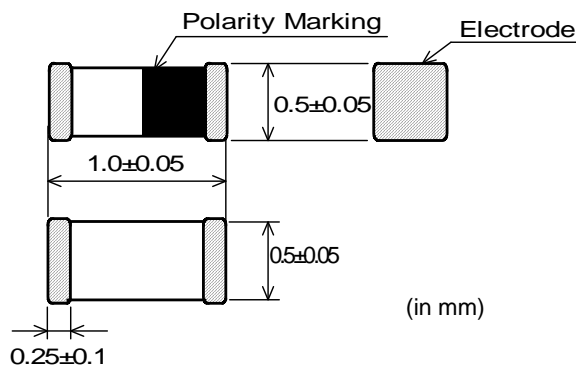
4. Appearance and Dimensions

5. Electrical Performance

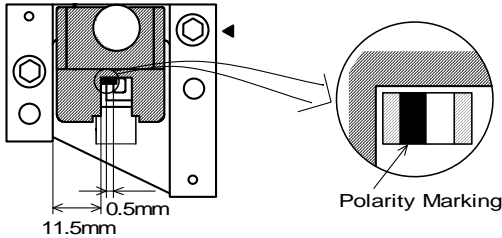
No.	Item	Specification	Test Method
5.1	Inductance	Inductance shall meet item 3.	Measuring Equipment: KEYSIGHT E4991A or equivalent Measuring Frequency: 100MHz Measuring Condition: Test signal level/ about 0dBm Electrode spaces / 0.5mm Electrical length/ 10mm Weight/about 1N to 5N Measuring Fixture: KEYSIGHT 16197A Position coil under test as shown in below and contact coil with each terminal by adding weight. Polarity marking should be a topside, and polarity marking should be in the direction of the fixture for position of chip coil.
5.2	Q	Q shall meet item 3.	 Measuring Method: See the endnote [Electrical Performance: Measuring Method of Inductance/Q]
5.3	DC Resistance	DC Resistance shall meet item 3.	Measuring Equipment: Digital multi meter
5.4	Self Resonant Frequency (S.R.F)	S.R.F shall meet item 3.	Measuring Equipment: Keysight 8753C or equivalent
5.5	Rated Current	Self temperature rise shall be limited to 25°C max.	The allowable current is applied.

6. Q200 Requirement**6.1. Performance (based on Table 5 for Magnetics (Inductors / Transformer))****AEC-Q200 Rev.D issued June 1, 2010**

AEC-Q200			Murata Specification / Deviation				
No	Stress	Test Method					
3	High Temperature Exposure	1000 hours at 125 deg C Set for 24 hours at room temperature, then measured.	Meet Table A after testing. Table A <table border="1"> <tr> <td>Appearance</td> <td>No damage</td> </tr> <tr> <td>Inductance Change (at 100MHz)</td> <td>Within ±10%</td> </tr> </table>	Appearance	No damage	Inductance Change (at 100MHz)	Within ±10%
Appearance	No damage						
Inductance Change (at 100MHz)	Within ±10%						
4	Temperature Cycling	1000 cycles -40 deg C to +125 deg C Set for 24 hours at room temperature, then measured.	Meet Table A after testing.				
7	Biased Humidity	1000 hours at 85 deg C, 85%RH unpowered.	Meet Table A after testing.				
8	Operational Life	Apply 125 deg C 1000 hours Set for 24 hours at room temperature, then measured	Meet Table A after testing.				
9	External Visual	Visual inspection	No abnormalities				
10	Physical Dimension	Meet ITEM 4 (Style and Dimensions)	No defects				
12	Resistance to Solvents	Per MIL-STD-202 Method 215	Not Applicable				

AEC-Q200			Murata Specification / Deviation						
No	Stress	Test Method							
13	Mechanical Shock	Per MIL-STD-202 Method 213 Condition C : 100g's(0.98N), 6ms, Half sine, 12.3ft/s	Meet Table A after testing.						
14	Vibration	5g's(0.049N) for 20 minutes, 12cycles each of 3 orientations Test from 10-2000Hz.	Meet Table A after testing.						
15	Resistance to Soldering Heat	No-heating Solder temperature 260C+/-5 deg C Immersion time 10s	Meet Table A after testing. Pre-heating 150C +/-10 deg C, 60s to 90s						
17	ESD	Per AEC-Q200-002	ESD Rank: refer to the Item3 (Rating). Meet Table A after testing						
18	Solderbility	Per J-STD-002	Method b : Not Applicable 90% of the terminations is to be soldered.						
19	Electrical Characterization	Measured : Inductance	No defects						
20	Flammability	Per UL-94	Not Applicable						
21	Board Flex	Epoxy-PCB(1.6mm) Deflection 2mm(min) Holding time 60s	Meet Table B after testing. <table border="1"> <thead> <tr> <th colspan="2">Table B</th> </tr> </thead> <tbody> <tr> <td>Appearance</td> <td>No damage</td> </tr> <tr> <td>DC resistance Change</td> <td>Within ±10%</td> </tr> </tbody> </table>	Table B		Appearance	No damage	DC resistance Change	Within ±10%
Table B									
Appearance	No damage								
DC resistance Change	Within ±10%								
22	Terminal Strength	Per AEC-Q200-006 A force of 17.7N for 60s	Murata Deviation Request: 5N No defects						

7.Specification of Packaging

7.1 Appearance and Dimensions of paper tape (8mm-wide)

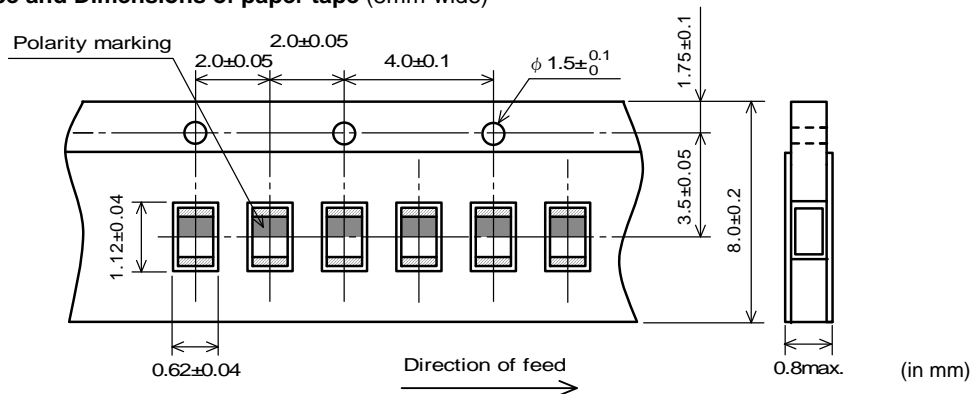

7.2 Specification of Taping

- (1) Packing quantity (standard quantity)
10,000 pcs. / reel
- (2) Packing Method
Products shall be packed in the cavity of the base tape and sealed by top tape and bottom tape.
- (3) Sprocket hole
The sprocket holes are to the right as the tape is pulled toward the user.
- (4) Spliced point
Base tape and Top tape has no spliced point.
- (5) Missing components number
Missing components number within 0.1 % of the number per reel or 1 pc., whichever is greater, and are not continuous. The Specified quantity per reel is kept.

7.3 Pull Strength

Top tape	5N min.
Bottom tape	

7.4 Peeling off force of cover tape

Speed of Peeling off	300mm/min
Peeling off force	0.1N to 0.6N (minimum value is typical)

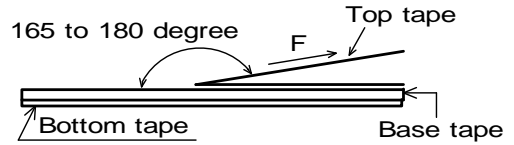

7.5 Dimensions of Leader-tape, Trailer and Reel

There shall be leader-tape (top tape and empty tape) and trailer-tape (empty tape) as follows.

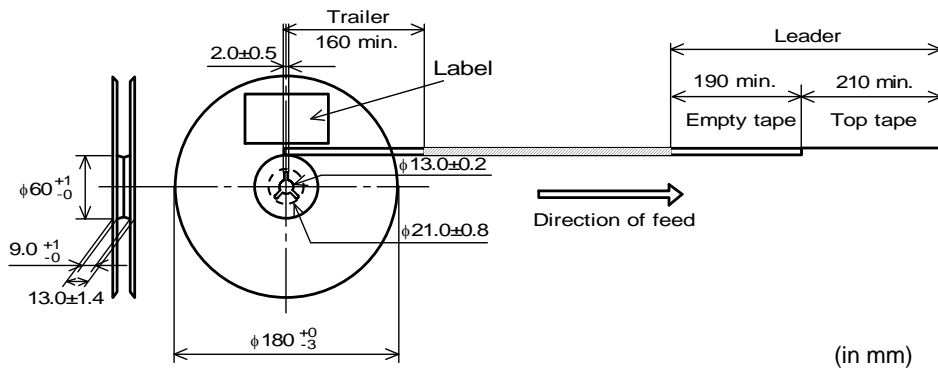

7.6 Marking for reel

Customer part number, MURATA part number, Inspection number(*1) ,RoHS Marking(*2), Quantity etc ...

*1) <Expression of Inspection No.>

□□ OOOO XXXX
(1) (2) (3)

(1) Factory Code

(2) Date First digit : Year / Last digit of year

Second digit: Month / Jan. to Sep. → 1 to 9, Oct. to Dec. → O, N, D

Third, Fourth digi : Day

(3) Serial No.

*2) <Expression of RoHS Marking>

ROHS - Y (Δ)
(1) (2)

(1) RoHS regulation conformity parts.

(2) MURATA classification number

7.7 Marking for Outside package (corrugated paper box)

Customer name, Purchasing order number, Customer part number, MURATA part number, RoHS Marking(*2) ,Quantity, etc ...

7.8. Specification of Outer Case

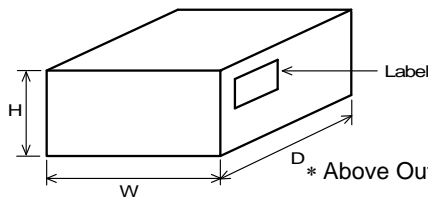

Outer Case Dimensions (mm)			Standard Reel Quantity in Outer Case (Reel)
W	D	H	
186	186	93	5

* Above Outer Case size is typical. It depends on a quantity of an order.

8. ⚠ Caution**8.1 Limitation of Applications**

Please contact us before using our products for the applications listed below which require especially high reliability for the prevention of defects which might directly cause damage to the third party's life, body or property.

- | | |
|-----------------------------------|--|
| (1) Aircraft equipment | (6) Transportation equipment (trains, ships, etc.) |
| (2) Aerospace equipment | (7) Traffic signal equipment |
| (3) Undersea equipment | (8) Disaster prevention / crime prevention equipment |
| (4) Power plant control equipment | (9) Data-processing equipment |
| (5) Medical equipment | (10) Applications of similar complexity and /or reliability requirements to the applications listed in the above |

8.2 Caution(Rating)

Do not exceed maximum rated current of the product. Thermal stress may be transmitted to the product and short/open circuit of the product or falling off the product may be occurred.

8.3 Fail-safe

Be sure to provide an appropriate fail-safe function on your product to prevent a second damage that may be caused by the abnormal function or the failure of our product.

9. Notice

Products can only be soldered with reflow.

This product is designed for solder mounting.

Please consult us in advance for applying other mounting method such as conductive adhesive.

Please check the mounting condition before using.

Using mounting conditions (nozzles, equipment conditions, etc.) that are not suitable for products may lead to pick up errors, misalignment, or damage to the product.

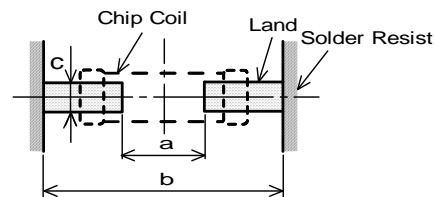
9.1 Land pattern designing

a	0.4
b	1.2
c	0.5

(in mm)

9.2 Flux, Solder

- Use rosin-based flux.
- Don't use highly acidic flux with halide content exceeding 0.2(wt)% (chlorine conversion value).
- Don't use water-soluble flux.
- Use Sn-3.0Ag-0.5Cu solder.
- Standard thickness of solder paste : 100 μm to 150 μm.

9.3 Reflow soldering conditions

- Inductance value may be changed a little due to the amount of solder.
So, the chip coil shall be soldered by reflow so that the solder volume can be controlled.
- Pre-heating should be in such a way that the temperature difference between solder and product surface is limited to 150°C max. Cooling into solvent after soldering also should be in such a way that the temperature difference is limited to 100°C max.
Insufficient pre-heating may cause cracks on the product, resulting in the deterioration of products quality.
- Standard soldering profile and the limit soldering profile is as follows.
The excessive limit soldering conditions may cause leaching of the electrode and / or resulting in the deterioration of product quality.

• Reflow soldering profile

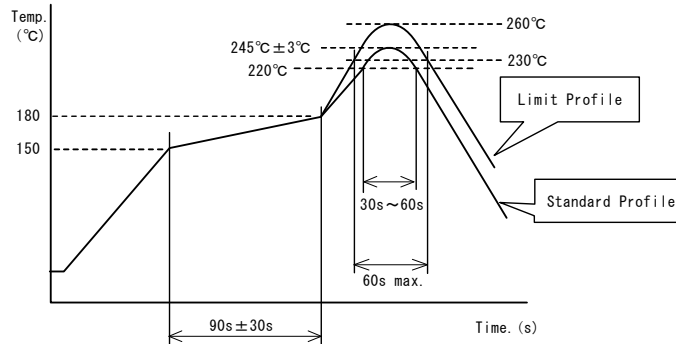

	Standard Profile	Limit Profile
Pre-heating	150°C ~ 180°C , 90s ± 30s	
Heating	above 220°C, 30s ~ 60s	above 230°C, 60s max.
Peak temperature	245°C ± 3°C	260°C, 10s
Cycle of reflow	2 times	

9.4 Reworking with soldering iron

The following conditions must be strictly followed when using a soldering iron.

Pre-heating	150°C, 1 min
Tip temperature	350°C max.
Soldering iron output	80W max.
Tip diameter	φ3mm max.
Soldering time	3(+1, -0)s
Time	2 times

Note :Do not directly touch the products with the tip of the soldering iron in order to prevent the crack on the products due to the thermal shock.

9.5 Solder Volume

- Solder shall be used not to be exceed the upper limits as shown below.
- Accordingly increasing the solder volume, the mechanical stress to Chip is also increased.
Exceeding solder volume may cause the failure of mechanical or electrical performance.

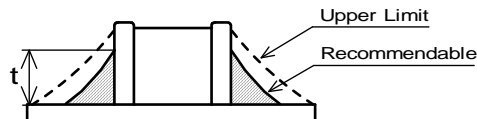

$$\frac{1}{3}t \leq t \leq T$$

T : thickness of product

9.6 Mount Shock

Over Mechanical stress to products at mounting process causes crack and electrical failure etc.

9.7 Product's location

The following shall be considered when designing and laying out P.C.B.'s.

- (1) P.C.B. shall be designed so that products are not subjected to the mechanical stress due to warping the board.

[Products direction]

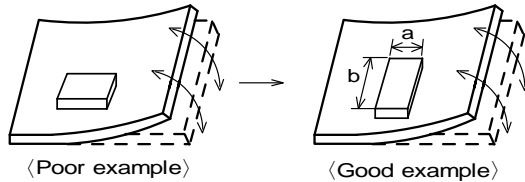

Products shall be located in the sideways direction (Length: $a < b$) to the mechanical stress.

- (2) Components location on P.C.B. separation.

It is effective to implement the following measures, to reduce stress in separating the board.

It is best to implement all of the following three measures; however, implement as many measures as possible to reduce stress.

Contents of Measures	Stress Level
(1) Turn the mounting direction of the component parallel to the board separation surface.	$A > D *1$
(2) Add slits in the board separation part.	$A > B$
(3) Keep the mounting position of the component away from the board separation surface.	$A > C$

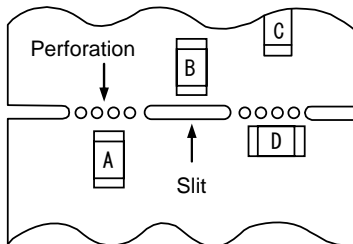

*1 $A > D$ is valid when stress is added vertically to the perforation as with Hand Separation.
If a Cutting Disc is used, stress will be diagonal to the PCB, therefore $A > D$ is invalid.

- (3) Mounting Components Near Screw Holes

When a component is mounted near a screw hole, it may be affected by the board deflection that occurs during the tightening of the screw. Mount the component in a position as far away from the screw holes as possible.

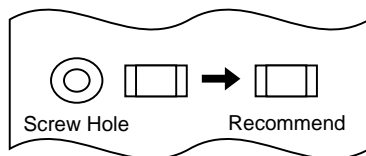
**9.8 Cleaning Conditions**

Products shall be cleaned on the following conditions.

- (1) Cleaning temperature shall be limited to 60°C max.(40°C max for IPA.)
- (2) Ultrasonic cleaning shall comply with the following conditions with avoiding the resonance phenomenon at the mounted products and P.C.B.
Power : 20 W / l max. Frequency : 28kHz to 40kHz Time : 5 min max.
- (3) Cleaner
 1. Alcohol type cleaner
Isopropyl alcohol (IPA)
 2. Aqueous agent
PINE ALPHA ST-100S
- (4) There shall be no residual flux and residual cleaner after cleaning. In the case of using aqueous agent, products shall be dried completely after rinse with de-ionized water in order to remove the cleaner.
- (5) Other cleaning Please contact us.

9.9 Resin coating

The inductance value may change and/or it may affect on the product's performance due to high cure-stress of resin to be used for coating / molding products. So please pay your careful attention when you select resin.

In prior to use, please make the reliability evaluation with the product mounted in your application set.

9.10 Handling of a substrate

After mounting products on a substrate, do not apply any stress to the product caused by bending or twisting to the substrate when cropping the substrate, inserting and removing a connector from the substrate or tightening screw to the substrate.

Excessive mechanical stress may cause cracking in the product.

Bending

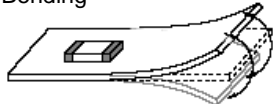

Twisting

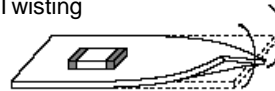

9.11 Storage and Handling Requirements

(1) Storage period

Use the products within 6 months after delivered.

Solderability should be checked if this period is exceeded.

(2) Storage conditions

• Products should be stored in the warehouse on the following conditions.

Temperature: -10°C to 40°C

Humidity: 15% to 85% relative humidity No rapid change on temperature and humidity

Don't keep products in corrosive gases such as sulfur, chlorine gas or acid, or it may cause oxidization of electrode, resulting in poor solderability.

• Products should be stored on the palette for the prevention of the influence from humidity, dust and so on.

• Products should be stored in the warehouse without heat shock, vibration, direct sunlight and so on.

• Products should be stored under the airtight packaged condition.

(3) Handling Condition

Care should be taken when transporting or handling product to avoid excessive vibration or mechanical shock.

10. Note

(1) Please make sure that your product has been evaluated in view of your specifications with our product being mounted to your product.

(2) You are requested not to use our product deviating from the reference specifications.

(3) The contents of this reference specification are subject to change without advance notice.

Please approve our product specifications or transact the approval sheet for product specifications before ordering.

<Electrical Performance:Measuring Method of Inductance/Q>

(1) Residual elements and stray elements of test fixture can be described by F-parameter shown in following.

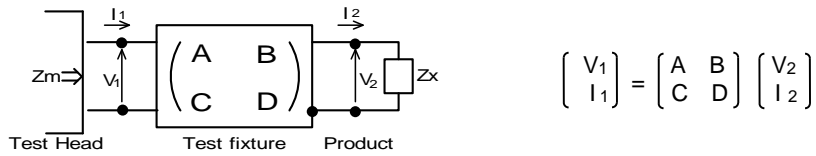

(2) The impedance of chip coil Z_x and measured value Z_m can be described by input/output current/voltage.

$$Z_m = \frac{V_1}{I_1} \quad , \quad Z_x = \frac{V_2}{I_2}$$

(3) Thus, the relation between Z_x and Z_m is following;

$$Z_x = \alpha \frac{Z_m - \beta}{1 - Z_m \Gamma} \quad \text{where, } \alpha = D / A = 1$$

$$\beta = B / D = Z_{sm} - (1 - Y_{om}) Z_{ss}$$

$$\Gamma = C / A = Y_{om}$$

- Z_{sm} : measured impedance of short chip
- Z_{ss} : residual impedance of short chip (0nH)
- Y_{om} : measured admittance when opening the fixture

(4) L_x and Q_x shall be calculated with the following equation.

$$L_x = \frac{\text{Im}(Z_x)}{2\pi f} \quad , \quad Q_x = \frac{\text{Im}(Z_x)}{\text{Re}(Z_x)}$$

L_x : Inductance of chip coil
 Q_x : Q of chip coil
 f : Measuring frequency

Mouser Electronics

Authorized Distributor

Click to View Pricing, Inventory, Delivery & Lifecycle Information:

Murata:

[LQG15HH10NJ02D](#) [LQG15HH12NJ02D](#) [LQG15HH15NJ02D](#) [LQG15HH18NJ02D](#) [LQG15HH1N0S02D](#)
[LQG15HH1N1S02D](#) [LQG15HH1N2S02D](#) [LQG15HH1N3S02D](#) [LQG15HH1N5S02D](#) [LQG15HH1N6S02D](#)
[LQG15HH1N8S02D](#) [LQG15HH22NJ02D](#) [LQG15HH27NJ02D](#) [LQG15HH2N0S02D](#) [LQG15HH2N2S02D](#)
[LQG15HH2N4S02D](#) [LQG15HH2N7S02D](#) [LQG15HH33NJ02D](#) [LQG15HH39NJ02D](#) [LQG15HH3N0S02D](#)
[LQG15HH3N3S02D](#) [LQG15HH3N6S02D](#) [LQG15HH3N9S02D](#) [LQG15HH47NJ02D](#) [LQG15HH4N3S02D](#)
[LQG15HH4N7S02D](#) [LQG15HH56NJ02D](#) [LQG15HH5N1S02D](#) [LQG15HH5N6S02D](#) [LQG15HH68NJ02D](#)
[LQG15HH6N2S02D](#) [LQG15HH6N8J02D](#) [LQG15HH7N5J02D](#) [LQG15HH82NJ02D](#) [LQG15HH8N2J02D](#)
[LQG15HH9N1J02D](#) [LQG15HHR10J02D](#) [LQG15HHR12J02D](#) [LQG15HHR15J02D](#) [LQG15HHR18J02D](#)
[LQG15HHR22J02D](#) [LQG15HHR27J02D](#) [LQG15HH7N5H02D](#) [LQG15HH3N9C02D](#) [LQG15HH5N6C02D](#)
[LQG15HH2N7C02D](#) [LQG15HHR10H02D](#) [LQG15HH1N1C02D](#) [LQG15HH39NH02D](#) [LQG15HH2N2C02D](#)
[LQG15HH56NH02D](#) [LQG15HHR12H02D](#) [LQG15HH1N6C02D](#) [LQG15HH1N8C02D](#) [LQG15HH3N3C02D](#)
[LQG15HH1N3C02D](#) [LQG15HH22NH02D](#) [LQG15HH6N8H02D](#) [LQG15HH15NH02D](#) [LQG15HH4N7C02D](#)
[LQG15HH8N2H02D](#) [LQG15HH33NH02D](#) [LQG15HHR27H02D](#) [LQG15HHR22H02D](#) [LQG15HH1N5C02D](#)
[LQG15HHR18H02D](#) [LQG15HH12NH02D](#) [LQG15HH2N0C02D](#) [LQG15HH5N1C02D](#) [LQG15HH2N4C02D](#)
[LQG15HH6N2C02D](#) [LQG15HH68NH02D](#) [LQG15HH1N2C02D](#) [LQG15HH18NH02D](#) [LQG15HH27NH02D](#)
[LQG15HH47NH02D](#) [LQG15HH10NH02D](#) [LQG15HHR15H02D](#) [LQG15HH1N0C02D](#) [LQG15HH9N1H02D](#)
[LQG15HH3N0C02D](#) [LQG15HH3N6C02D](#) [LQG15HH82NH02D](#) [LQG15HH4N3C02D](#) [LQG15HH12NG02](#)
[LQG15HHR12G02D](#) [LQG15HHR12G02J](#) [LQG15HH3N0B02D](#) [LQG15HH3N3B02D](#) [LQG15HH4N7B02D](#)
[LQG15HH68NG02D](#) [LQG15HH6N2B02D](#) [LQG15HH9N1G02D](#) [LQG15HHR22G02D](#) [LQG15HH2N0B02D](#)
[LQG15HH10NG02D](#) [LQG15HH1N1B02D](#) [LQG15HH2N4B02D](#) [LQG15HH4N3B02D](#) [LQG15HH15NG02D](#)