



2430S

ERGO™ Snipe Nose Pliers with Insulated Dual-Component Handles and Phosphate Finish



PRODUCT DETAILS

- Two-component ERGO™ insulated handles: thermoplastic surface on tough polypropylene base provides superior grip
- Developed according to the scientific ERGO™ process
- For working on live equipment up to 1000 V in compliance with IEC 60900
- Cutting capacity: 2.5 mm to 3 mm copper, 1.8 mm iron, 1.4 mm to 1.6 mm iron alloy
- Half-round serrated jaws for gripping flat and round material with great accessibility in confined spaces

- Straight jaws with hardened cutting edges for cutting soft and hard wire
- High-performance alloy steel
- Phosphate finish, anti-corrosion treated
- Standards: ISO 5745, IEC 60900
- Every tool is tested at 10,000 V for 10 seconds at the end of the manufacturing process

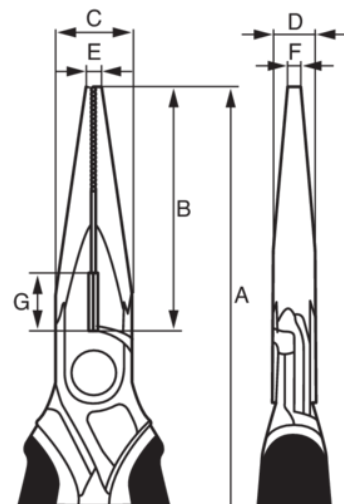





Follow the Fish!







PRODUCT ATTRIBUTES





Product: 2430S-140

A	140 mm	B	37 mm	C	15 mm
D	7,8 mm	E	2,5 mm	F	2 mm
G	12 mm	 2.5 mm	 1.8 mm		
 1.4 mm		 120 g			

Product: 2430 S-160

A	160 mm	B	49 mm	C	16 mm
D	8 mm	E	3 mm	F	2.5 mm
G	12 mm	 3.0 mm	 1.8 mm		
 1.6 mm		 160 g			

Product: 2430 S-200

A	200 mm	B	72 mm	C	17 mm
D	9 mm	E	4 mm	F	2.5 mm
G	12 mm	 3.0 mm	 1.8 mm		
 1.6 mm		 170 g			

