

# SPTAF 1/ 6-3,5-IL - PCB terminal block



1861975

<https://www.phoenixcontact.com/us/products/1861975>

Please be informed that the data shown in this PDF document is generated from our Online Catalog. Please find the complete data in the user documentation. Our General Terms of Use for Downloads are valid.

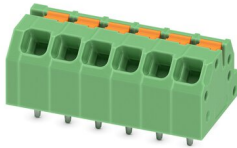

PCB terminal block, nominal current: 16 A, rated voltage (III/2): 160 V, nominal cross section: 1.5 mm<sup>2</sup>, number of potentials: 6, number of rows: 1, number of positions per row: 6, product range: SPTAF 1/..-IL, pitch: 3.5 mm, connection method: Push-in spring connection, mounting: Wave soldering, conductor/PCB connection direction: 45 °, color: green, Pin layout: Linear pinning, Solder pin [P]: 2.6 mm, number of solder pins per potential: 2, type of packaging: packed in cardboard

## Your advantages

- Time saving push-in connection, tools not required
- Defined contact force ensures that contact remains stable over the long term
- Intuitive use through colour coded actuation lever
- Small component size for applications where space is at a premium
- Quick and convenient testing using integrated test option

## Commercial Data

Item number	1861975
Packing unit	1 pc
Minimum order quantity	80 pc
Sales Key	AA12
Product Key	AALBGJ
GTIN	4055626135014
Weight per Piece (including packing)	3.021 g
Weight per Piece (excluding packing)	3.021 g
Customs tariff number	85369010
Country of origin	PL

# SPTAF 1/ 6-3,5-IL - PCB terminal block



1861975

<https://www.phoenixcontact.com/us/products/1861975>

## Technical Data

### Product properties

Product line	COMBICON Terminals S
Product type	Printed circuit board terminal
Product family	SPTAF 1/..-IL
Number of positions	6
Pitch	3.5 mm
Number of connections	6
Number of rows	1
Number of potentials	6
Pin layout	Linear pinning
Solder pins per potential	2

### Electrical properties

Nominal current $I_N$	16 A
Nominal voltage $U_N$	160 V
Degree of pollution	3
Rated voltage (III/3)	160 V
Rated surge voltage (III/3)	2.5 kV
Rated voltage (III/2)	160 V
Rated surge voltage (III/2)	2.5 kV
Rated voltage (II/2)	320 V
Rated surge voltage (II/2)	2.5 kV

### Connection data

#### Connection technology

Nominal cross section	1.5 mm <sup>2</sup>
-----------------------	---------------------

#### Conductor connection

Connection method	Push-in spring connection
Conductor cross section rigid	0.2 mm <sup>2</sup> ... 1.5 mm <sup>2</sup> (When connecting and possibly adjusting a solid conductor of 1.5 mm <sup>2</sup> , the mechanical lateral forces, which can affect the terminal block, have to be absorbed by lateral support.) 0.34 mm <sup>2</sup> ... 1.5 mm <sup>2</sup> (Push-in connection)
Conductor cross section flexible	0.2 mm <sup>2</sup> ... 1.5 mm <sup>2</sup>
Conductor cross section AWG	24 ... 16
Conductor cross section flexible, with ferrule without plastic sleeve	0.25 mm <sup>2</sup> ... 0.75 mm <sup>2</sup> (Conductor connection with open terminal point) 0.5 mm <sup>2</sup> ... 0.75 mm <sup>2</sup> (Push-in connection)
Conductor cross section, flexible, with ferrule, with plastic sleeve	0.25 mm <sup>2</sup> ... 0.75 mm <sup>2</sup> (Conductor connection with open terminal point) 0.5 mm <sup>2</sup> ... 0.75 mm <sup>2</sup> (Push-in connection)
Stripping length	8 mm

# SPTAF 1/ 6-3,5-IL - PCB terminal block



1861975

<https://www.phoenixcontact.com/us/products/1861975>

## Mounting

Mounting type	Wave soldering
Pin layout	Linear pinning
Connection method	Push-in spring connection

### Processing notes

Process	Wave soldering
---------	----------------

## Material specifications

### Material data - contact

Note	WEEE/RoHS-compliant, free of whiskers according to IEC 60068-2-82/JEDEC JESD 201
Contact material	Cu alloy
Surface characteristics	hot-dip tin-plated
Metal surface terminal point (top layer)	Tin (2 - 4 µm Sn)
Metal surface soldering area (top layer)	Tin (2 - 4 µm Sn)

### Material data - housing

Color (Housing)	green (6021)
Insulating material	PA
Insulating material group	I
CTI according to IEC 60112	600
Flammability rating according to UL 94	V0
Glow wire flammability index GWFI according to EN 60695-2-12	850
Glow wire ignition temperature GWIT according to EN 60695-2-13	775
Temperature for the ball pressure test according to EN 60695-10-2	125 °C

### Material data – actuating element

Color (Actuating element)	orange (2003)
Insulating material	PBT
Insulating material group	IIIa
CTI according to IEC 60112	275
Flammability rating according to UL 94	V0

## Notes

Note on application	Maximum permissible outer diameter of the wire insulation ≤ 3 mm
---------------------	--

## Dimensions

# SPTAF 1/ 6-3,5-IL - PCB terminal block



1861975

<https://www.phoenixcontact.com/us/products/1861975>

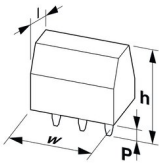
Dimensional drawing	
Pitch	3.5 mm
Width [w]	22.5 mm
Height [h]	10.6 mm
Length [l]	11 mm
Installed height	8 mm
Solder pin length [P]	2.6 mm
Pin dimensions	0.75 x 0.3 mm

## PCB design

Pin spacing	5 mm
Hole diameter	1.1 mm

## Mechanical tests

### Test for conductor damage and slackening

Specification	IEC 60999-1:1999-11
Result	Test passed

### Repeated connection and disconnection

Specification	IEC 60999-1:1999-11
Result	Test passed

### Pull-out test

Specification	IEC 60999-1:1999-11
Conductor cross section/conductor type/tractive force setpoint/actual value	0.2 mm <sup>2</sup> / solid / > 10 N
	0.25 mm <sup>2</sup> / flexible / > 10 N
	1.5 mm <sup>2</sup> / solid / > 40 N
	1.5 mm <sup>2</sup> / flexible / > 40 N

## Electrical tests

### Temperature-rise test

Specification	IEC 60947-7-4:2013-08
Requirement temperature-rise test	The sum of ambient temperature and temperature rise of the PCB terminal block shall not exceed the upper limiting temperature.

### Short-time withstand current

Specification	IEC 60947-7-4:2013-08
---------------	-----------------------

### Insulation resistance

Specification	IEC 60512-3-1:2002-02
---------------	-----------------------

# SPTAF 1/ 6-3,5-IL - PCB terminal block



1861975

<https://www.phoenixcontact.com/us/products/1861975>

Insulation resistance, neighboring positions	> 5 MΩ
--	--------

## Air clearances and creepage distances |

Specification	IEC 60947-1:2007-06 + A1:2010-12
Insulating material group	I
Comparative tracking index (IEC 60112)	CTI 600
Rated insulation voltage (III/3)	160 V
Rated surge voltage (III/3)	2.5 kV
minimum clearance value - non-homogenous field (III/3)	1.5 mm
minimum creepage distance (III/3)	2 mm
Rated insulation voltage (III/2)	160 V
Rated surge voltage (III/2)	2.5 kV
minimum clearance value - non-homogenous field (III/2)	1.5 mm
minimum creepage distance (III/2)	0.8 mm
Rated insulation voltage (II/2)	320 V
Rated surge voltage (II/2)	2.5 kV
minimum clearance value - non-homogenous field (II/2)	1.5 mm
minimum creepage distance (II/2)	1.6 mm

## Environmental and real-life conditions

### Vibration test

Specification	IEC 60068-2-6:2007-12
Frequency	10 - 150 - 10 Hz
Sweep speed	1 octave/min
Amplitude	0.35 mm (10 Hz ... 60.1 Hz)
Sweep speed	5g (60.1 Hz ... 150 Hz)
Test duration per axis	2.5 h

### Glow-wire test

Specification	IEC 60695-2-10:2013-04
Temperature	850 °C
Time of exposure	5 s

### Aging

Specification	IEC 60947-7-4:2013-08
---------------	-----------------------

### Ambient conditions

Ambient temperature (operation)	-40 °C ... 100 °C (dependent on the derating curve)
Ambient temperature (storage/transport)	-40 °C ... 70 °C
Relative humidity (storage/transport)	30 % ... 70 %
Ambient temperature (assembly)	-5 °C ... 100 °C

# SPTAF 1/ 6-3,5-IL - PCB terminal block



1861975

<https://www.phoenixcontact.com/us/products/1861975>

## Drawings

Diagram

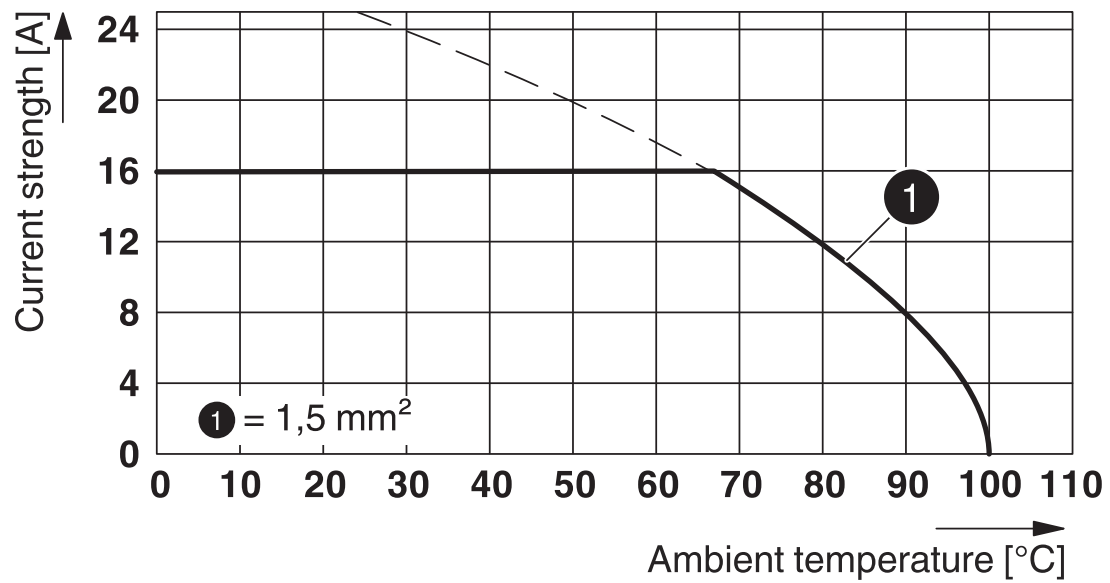

Type: SPTAF 1/...-3,5-IL(EL)

Drilling plan/solder pad geometry

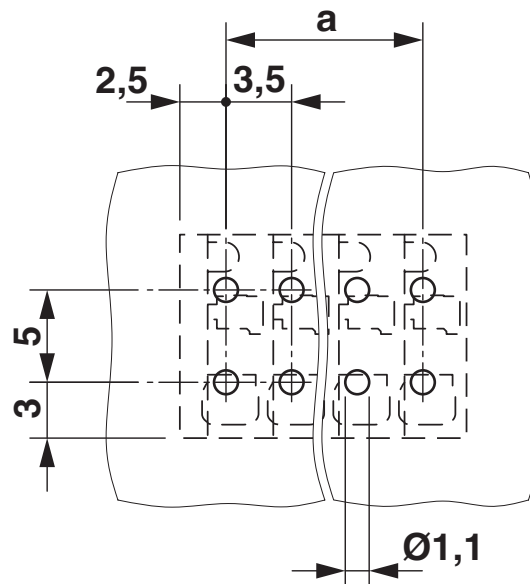

# SPTAF 1/ 6-3,5-IL - PCB terminal block



1861975

<https://www.phoenixcontact.com/us/products/1861975>

Dimensional drawing

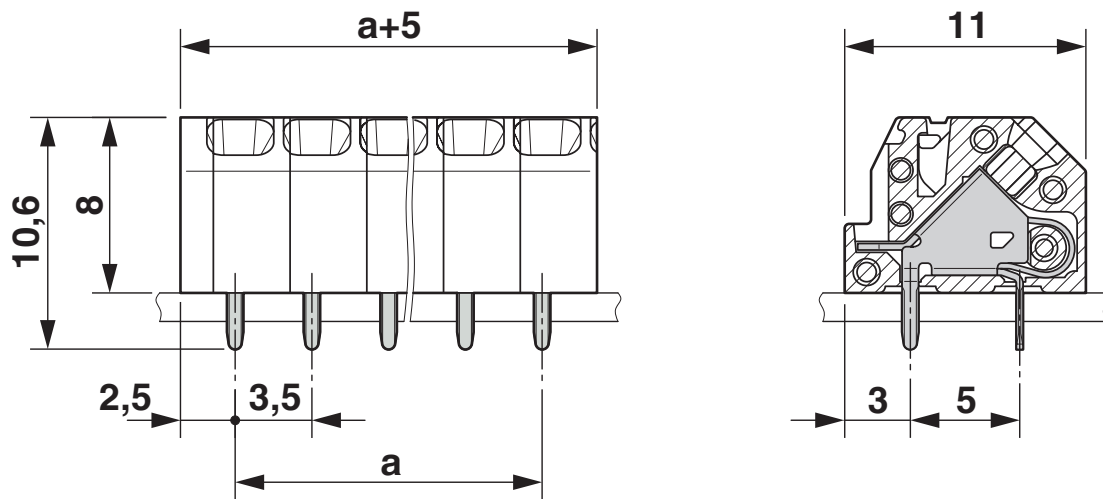

# SPTAF 1/ 6-3,5-IL - PCB terminal block





1861975

<https://www.phoenixcontact.com/us/products/1861975>

## Approvals

To download certificates, visit the product detail page: <https://www.phoenixcontact.com/us/products/1861975>

 <b>cULus Recognized</b> Approval ID: E60425-20061129				
	Nominal Voltage $U_N$	Nominal Current $I_N$	Cross Section AWG	Cross Section $\text{mm}^2$
Use group B	300 V	8 A	24 - 16	-
Use group D	300 V	8 A	24 - 16	-

 <b>EAC</b> Approval ID: B.01687				
--	--	--	--	--

 <b>VDE Zeichengenehmigung</b> Approval ID: 40047107				
	Nominal Voltage $U_N$	Nominal Current $I_N$	Cross Section AWG	Cross Section $\text{mm}^2$
	160 V	16 A	-	0.2 - 1.5



# SPTAF 1/ 6-3,5-IL - PCB terminal block



1861975

<https://www.phoenixcontact.com/us/products/1861975>

## Classifications

### ECLASS

ECLASS-11.0	27460101
ECLASS-12.0	27460101
ECLASS-13.0	27460101

### ETIM

ETIM 8.0	EC002643
----------	----------

### UNSPSC

UNSPSC 21.0	39121400
-------------	----------

# SPTAF 1/ 6-3,5-IL - PCB terminal block



1861975

<https://www.phoenixcontact.com/us/products/1861975>

## Environmental Product Compliance

China RoHS	Environmentally friendly use period: unlimited = EFUP-e
	No hazardous substances above threshold values

# SPTAF 1/ 6-3,5-IL - PCB terminal block



1861975

<https://www.phoenixcontact.com/us/products/1861975>

## Accessories

### SZF 0-0,4X2,5 - Screwdriver

1204504

<https://www.phoenixcontact.com/us/products/1204504>



Actuation tool, for ST terminal blocks, also suitable for use as a bladed screwdriver, size: 0.4 x 2.5 x 75 mm, 2-component grip, with non-slip grip

### CRIMPFOX 6 - Crimping pliers

1212034

<https://www.phoenixcontact.com/us/products/1212034>



Crimping pliers, for ferrules without insulating collar according to DIN 46228 Part 1 and ferrules with insulating collar according to DIN 46228 Part 4, 0.25 mm<sup>2</sup> ... 6.0 mm<sup>2</sup>, lateral entry, trapezoidal crimp

Phoenix Contact 2023 © - all rights reserved

<https://www.phoenixcontact.com>

Phoenix Contact USA

586 Fulling Mill Road

Middletown, PA 17057, United States

(+717) 944-1300

[info@phoenixcon.com](mailto:info@phoenixcon.com)