



L-1034GDT 2mm Flat Top LED Lamp

DESCRIPTION

- The Green source color devices are made with Gallium Phosphide Green Light Emitting Diode

FEATURES

- Mounts flush with panel
- Low power consumption
- Long life - solid state reliability
- RoHS compliant

APPLICATIONS

- Status indicator
- Illuminator
- Signage applications
- Decorative and entertainment lighting
- Commercial and residential architectural lighting

PACKAGE DIMENSIONS

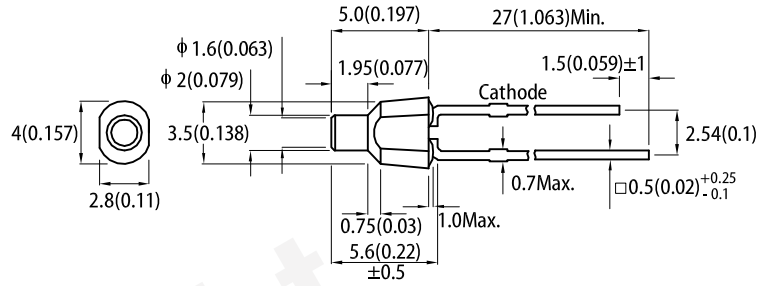

Recommended PCB Layout

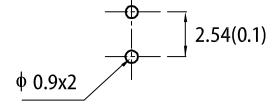

Notes:

- All dimensions are in millimeters (inches).
- Tolerance is $\pm 0.25(0.01)$ unless otherwise noted.
- Lead spacing is measured where the leads emerge from the package.
- The specifications, characteristics and technical data described in the datasheet are subject to change without prior notice.

SELECTION GUIDE

Part Number	Emitting Color (Material)	Lens Type	Iv (mcd) @ 10mA ^[2]		Viewing Angle ^[1]
			Min.	Typ.	2 θ 1/2
L-1034GDT	■ Green (GaP)	Green Diffused	2	5	140°

- Notes:
- $\theta 1/2$ is the angle from optical centerline where the luminous intensity is 1/2 of the optical peak value.
 - Luminous intensity / luminous flux: +/-15%.
 - Luminous intensity value is traceable to CIE127-2007 standards.

ELECTRICAL / OPTICAL CHARACTERISTICS at T_A=25°C

Parameter	Symbol	Emitting Color	Value		Unit
			Typ.	Max.	
Wavelength at Peak Emission I _F = 10mA	λ _{peak}	Green	565	-	nm
Dominant Wavelength I _F = 10mA	λ _{dom} ^[1]	Green	568	-	nm
Spectral Bandwidth at 50% Φ REL MAX I _F = 10mA	Δλ	Green	30	-	nm
Capacitance	C	Green	15	-	pF
Forward Voltage I _F = 10mA	V _F ^[2]	Green	2.0	2.4	V
Reverse Current (V _R = 5V)	I _R	Green	-	10	μA

Notes:

1. The dominant wavelength (λ_d) above is the setup value of the sorting machine. (Tolerance λ_d : ±1nm.)
2. Forward voltage: ±0.1V.
3. Wavelength value is traceable to CIE127-2007 standards.
4. Excess driving current and / or operating temperature higher than recommended conditions may result in severe light degradation or premature failure.

ABSOLUTE MAXIMUM RATINGS at T_A=25°C

Parameter	Symbol	Value	Unit
Power Dissipation	P _D	62.5	mW
Reverse Voltage	V _R	5	V
Junction Temperature	T _J	110	°C
Operating Temperature	T _{op}	-40 to +85	°C
Storage Temperature	T _{stg}	-40 to +85	°C
DC Forward Current	I _F	25	mA
Peak Forward Current	I _{FM} ^[1]	140	mA
Electrostatic Discharge Threshold (HBM)	-	8000	V
Lead Solder Temperature ^[2]		260°C For 3 Seconds	
Lead Solder Temperature ^[3]		260°C For 5 Seconds	

Notes:

1. 1/10 Duty Cycle, 0.1ms Pulse Width.
2. 2mm below package base.
3. 5mm below package base.
4. Relative humidity levels maintained between 40% and 60% in production area are recommended to avoid the build-up of static electricity – Ref JEDEC/JESD625-A and JEDEC/J-STD-033.

TECHNICAL DATA

RELATIVE INTENSITY vs. WAVELENGTH

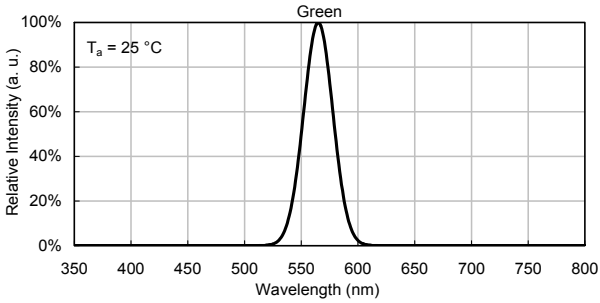

SPATIAL DISTRIBUTION

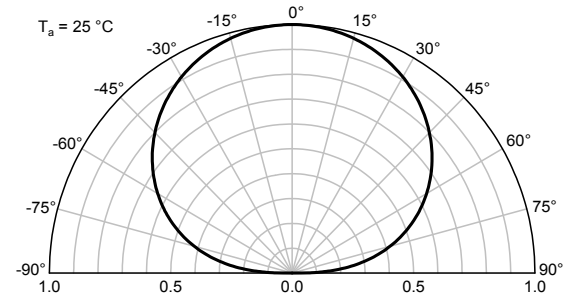

GREEN

Forward Current vs. Forward Voltage

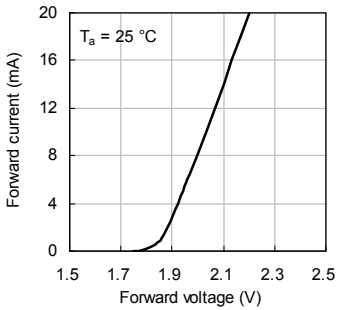

Luminous Intensity vs. Forward Current

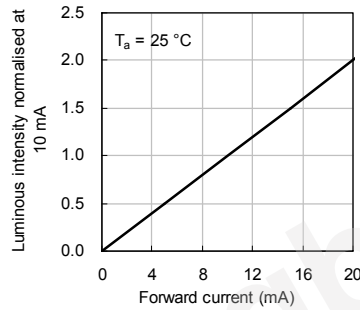

Forward Current Derating Curve

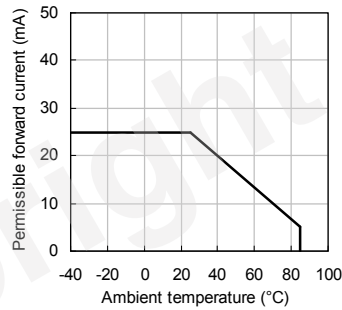

Luminous Intensity vs. Ambient Temperature

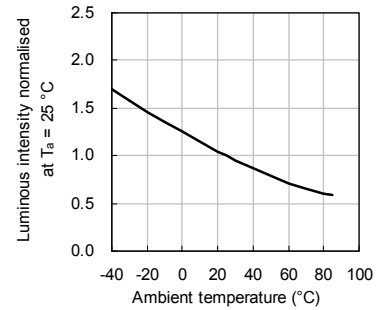

RECOMMENDED WAVE SOLDERING PROFILE

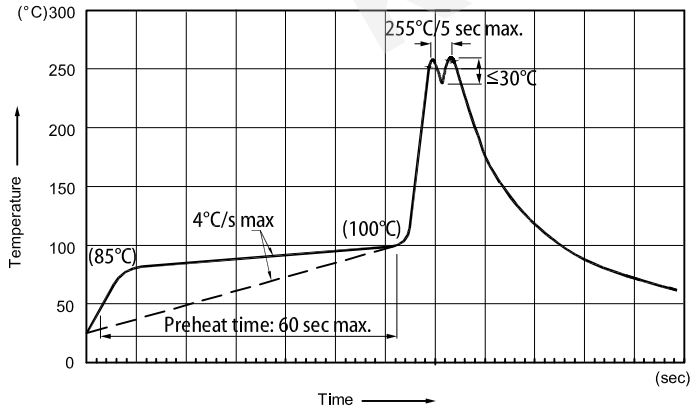

Notes:

1. Recommend pre-heat temperature of 105°C or less (as measured with a thermocouple attached to the LED pins) prior to immersion in the solder wave with a maximum solder bath temperature of 260°C
2. Peak wave soldering temperature between 245°C ~ 255°C for 3 sec (5 sec max).
3. Do not apply stress to the epoxy resin while the temperature is above 85°C.
4. Fixtures should not incur stress on the component when mounting and during soldering process.
5. SAC 305 solder alloy is recommended.
6. No more than one wave soldering pass.

PACKING & LABEL SPECIFICATIONS

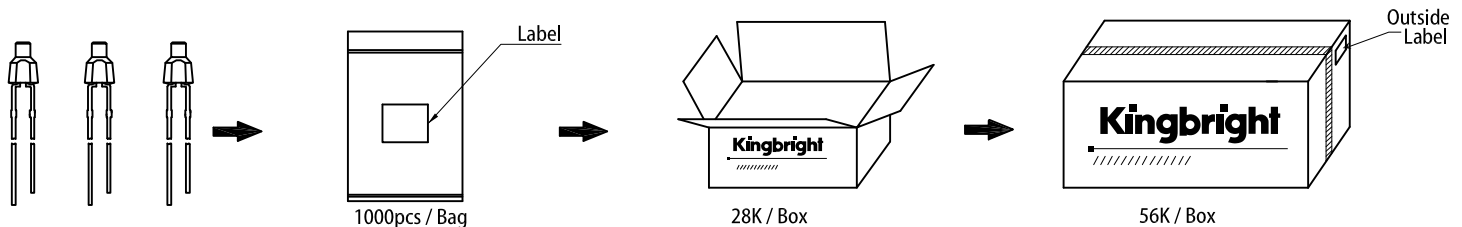

Kingbright XXXXXXXXXX-XXXX

P/NO: XXXXXXXX

QTY: XXXXXpcs
S/N: XXXX
CODE: XX
COUNTRY: CN QC DATE: XXX XX XXXX PASSED
LOT NO:

XXXXXXXXXX-XXXX
(SP)XXXXXXXXXX RoHS Compliant

PRECAUTIONS

Storage conditions

1. Avoid continued exposure to the condensing moisture environment and keep the product away from rapid transitions in ambient temperature.
2. LEDs should be stored with temperature $\leq 30^{\circ}\text{C}$ and relative humidity $< 60\%$.
3. Product in the original sealed package is recommended to be assembled within 72 hours of opening.
Product in opened package for more than a week should be baked for 30 (+10/-0) hours at $85 \sim 100^{\circ}\text{C}$.

LED Mounting Method

1. The lead pitch of the LED must match the pitch of the mounting holes on the PCB during component placement.
Lead-forming may be required to insure the lead pitch matches the hole pitch.
Refer to the figure below for proper lead forming procedures.

Note 1-3: Do not route PCB trace in the contact area between the leadframe and the PCB to prevent short-circuits.

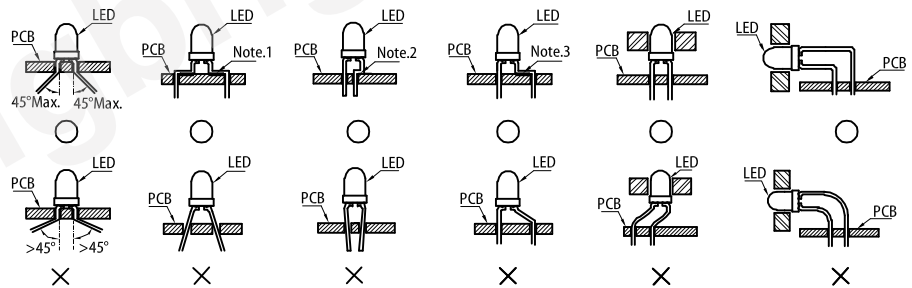

" O " Correct mounting method " X " Incorrect mounting method

2. When soldering wires to the LED, each wire joint should be separately insulated with heat-shrink tube to prevent short-circuit contact. Do not bundle both wires in one heat shrink tube to avoid pinching the LED leads. Pinching stress on the LED leads may damage the internal structures and cause failure.

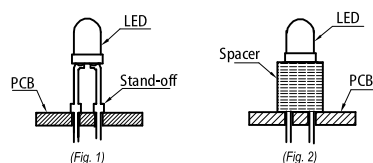
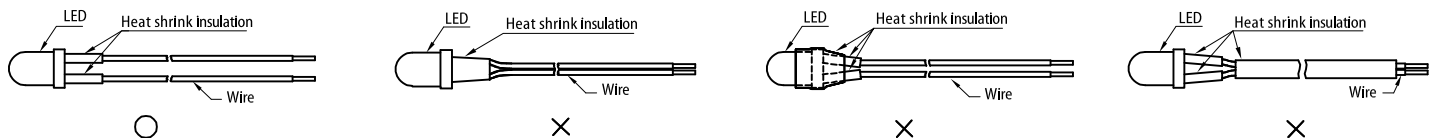

3. Use stand-offs (Fig. 1) or spacers (Fig. 2) to securely position the LED above the PCB.
4. Maintain a minimum of 3mm clearance between the base of the LED lens and the first lead bend (Fig. 3, Fig. 4).
5. During lead forming, use tools or jigs to hold the leads securely so that the bending force will not be transmitted to the LED lens and its internal structures. Do not perform lead forming once the component has been mounted onto the PCB. (Fig. 5)

Lead Forming Procedures

1. Do not bend the leads more than twice. (Fig. 6)
2. During soldering, component covers and holders should leave clearance to avoid placing damaging stress on the LED during soldering. (Fig. 7)
3. The tip of the soldering iron should never touch the lens epoxy.
4. Through-hole LEDs are incompatible with reflow soldering.
5. If the LED will undergo multiple soldering passes or face other processes where the part may be subjected to intense heat, please check with Kingbright for compatibility.

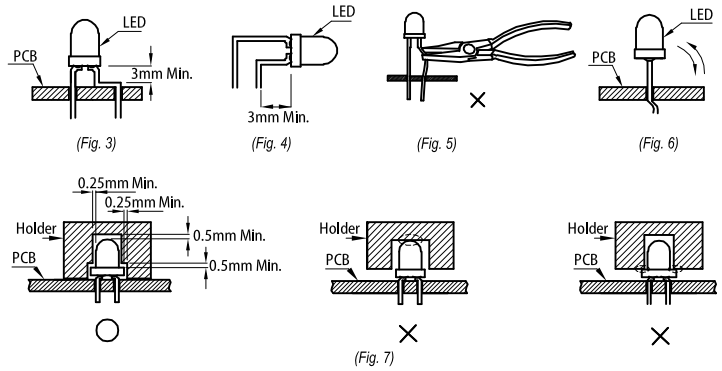

PRECAUTIONARY NOTES

1. The information included in this document reflects representative usage scenarios and is intended for technical reference only.
2. The part number, type, and specifications mentioned in this document are subject to future change and improvement without notice. Before production usage customer should refer to the latest datasheet for the updated specifications.
3. When using the products referenced in this document, please make sure the product is being operated within the environmental and electrical limits specified in the datasheet. If customer usage exceeds the specified limits, Kingbright will not be responsible for any subsequent issues.
4. The information in this document applies to typical usage in consumer electronics applications. If customer's application has special reliability requirements or have life-threatening liabilities, such as automotive or medical usage, please consult with Kingbright representative for further assistance.
5. The contents and information of this document may not be reproduced or re-transmitted without permission by Kingbright.
6. All design applications should refer to Kingbright application notes available at https://www.kingbright.com/application_notes