

KEMET Part Number: L0806B270JSWST
(L0806B270JSWST)

KEMET
a YAGEO company

KEMET, L-SWS, Commercial Grade, 27 uH, 5%

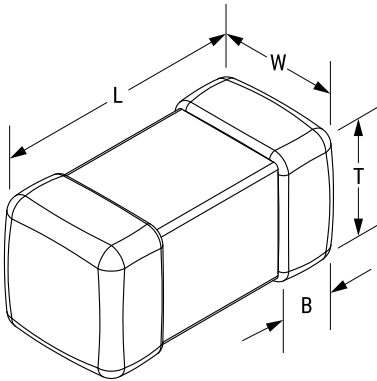

Dimensions

Chip Size	0806
L	2mm +/-0.2mm
W	1.6mm +/-0.2mm
T	1.6mm +/-0.2mm
B	0.5mm +/-0.2mm

Packaging Specifications

Packaging:	T&R
Packaging Quantity:	2000

General Information

Series:	L-SWS
Style:	SMD Chip
RoHS:	Yes

Specifications

Inductance:	27 uH
Inductance Tolerance:	5%
Temperature Range:	-40/+105°C
Current:	130 mAmps (MAX)
DC Resistance:	3.2 Ohms
Self-Resonant Frequency:	16 MHz MIN

Statements of suitability for certain applications are based on our knowledge of typical operating conditions for such applications, but are not intended to constitute - and we specifically disclaim - any warranty concerning suitability for a specific customer application or use. This Information is intended for use only by customers who have the requisite experience and capability to determine the correct products for their application. Any technical advice inferred from this Information or otherwise provided by us with reference to the use of our products is given gratis, and we assume no obligation or liability for the advice given or results obtained.

KEMET
a YAGEO company