

Description

XD17324 series are quad operational amplifier that provide high gain and internal phase compensation, with single power supply. They can be widely used to control equipments.

Features

- Wide range of supply voltage, and single power supply used
- Internal phase compensation
- Wide range of common mode voltage, and possible to operate with an input about 0 V
- Low electro-magnetic susceptibility level

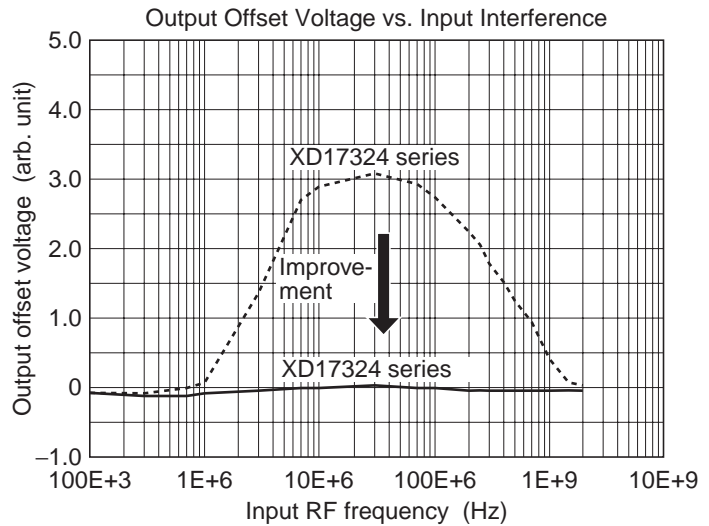
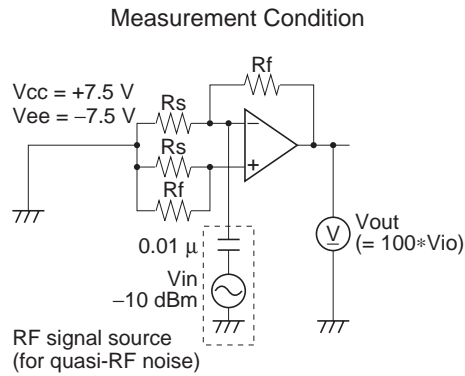

Pin Arrangement

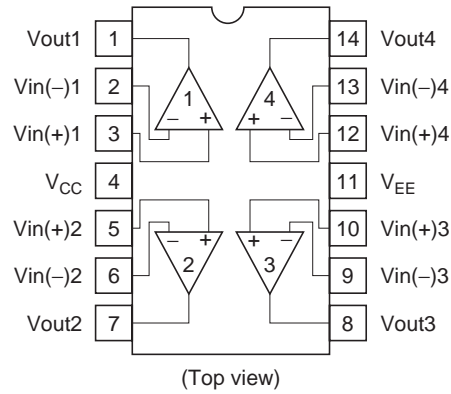

Circuit Schematic (1/4)

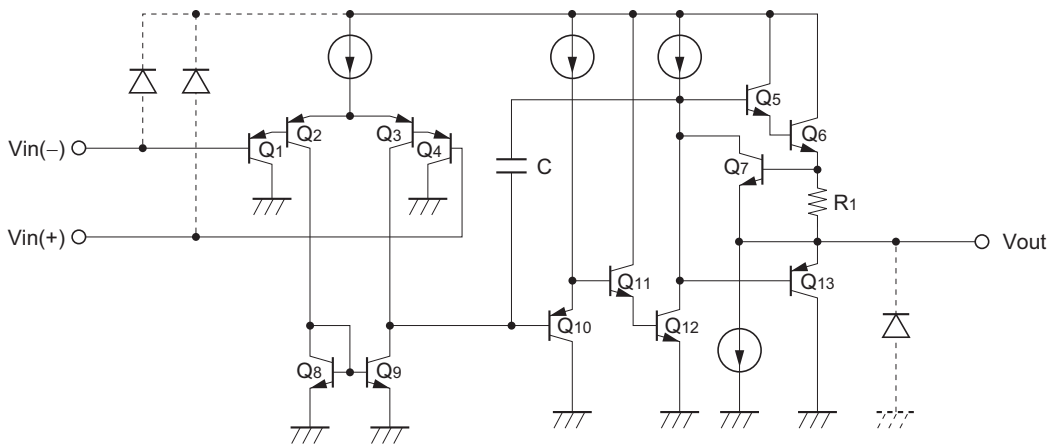

Note: If Input/Output terminals voltage over the absolute maximum ratings, there is possibility of mis-operation, characteristics deterioration and destruction, because of the current's flowing to parasitic diode in IC. The Input/Output terminals are recommended to be protected with the clamp circuit which using the diode with low forward voltage (like schottky barrier diode) when there is a possibility for the Input/Output terminals voltage exceeds the absolute maximum ratings.

Absolute Maximum Ratings

(Ta = 25°C)

Item	Symbol	Ratings	Unit
Power supply voltage	V _{CC}	32	V
Output sink current	I _{osink}	50	mA
Common mode input voltage	V _{CM}	-0.3 to +V _{CC}	V
Differential input voltage	V _{in(diff)}	±V _{CC}	V
Output voltage	V _{out}	-0.3 to +V _{CC}	V
Allowable power dissipation	DIP	P _T	625 *2
Operating temperature		T _{opr}	-40 to +85
Storage temperature		T _{stg}	-55 to +125

Notes: 1. XD17324:

This is the allowable values up to Ta = 50°C. Derate by 8.3 mW/°C.

2. XD17324:

When it is mounted on glass epoxy board of 40 mm × 40 mm × 1.6 mm with 10% wiring density, value at Ta ≤ 25°C. If Ta > 25°C, derated by 6.25 mW/°C.

When it is mounted on glass epoxy board of 40 mm × 40 mm × 1.6 mm with 30% wiring density. If Ta > 32°C, derated by 6.70 mW/°C.

3. XD17324:

These are the allowable values up to Ta = 25°C. Derate by 4 mW/°C above that temperature.

Electrical Characteristics

(V_{CC} = +15 V, Ta = 25°C)

Item	Symbol	Min	Typ	Max	Unit	Test Conditions
Input offset voltage	V _{IO}	—	2	7	mV	V _{CM} = 7.5 V, R _S = 50 Ω, R _f = 50 kΩ
Input offset current	I _{IO}	—	5	50	nA	V _{CM} = 7.5 V, I _{IO} = I _{I(-)} - I _{I(+)}
Input bias current	I _{IB}	—	30	500	nA	V _{CM} = 7.5 V
Power source rejection ratio	PSRR	—	93	—	dB	f = 100 Hz, R _S = 1 kΩ, R _j = 100 kΩ
Voltage gain	A _{VD}	75	90	—	dB	R _S = 1 kΩ, R _f = 100 kΩ, R _L = ∞
Common mode rejection ratio	CMR	—	80	—	dB	R _S = 50 Ω, R _f = 5 kΩ
Common mode input voltage range	V _{CM}	-0.3	—	13.5	V	R _S = 1 kΩ, R _f = 100 kΩ, f = 100 Hz
Maximum output voltage	V _{OP-P}	—	13.6	—	V	f = 100 Hz, R _S = 1 kΩ, R _f = 100 kΩ, R _L = 20 kΩ
Output source current	I _{osource}	20	40	—	mA	V _{IN+} = 1 V, V _{IN-} = 0 V, V _{OH} = 10 V
Output sink current	I _{osink}	10	20	—	mA	V _{IN} = 0 V, V _{IN} = 1 V, V _{OL} = 2.5 V
Supply current	I _{CC}	—	0.8	2	mA	V _{IN} = GND, R _L = ∞
Slew rate	SR	—	0.19	—	V/μs	f = 1.5 kHz, V _{CM} = 7.5 V, R _L = ∞
Channel separation *1	CS	—	(120)	—	dB	f = 1 kHz
Output sink current	I _{osink}	15	50	—	μA	V _{IN+} = 0 V, V _{IN-} = 1 V, V _{OL} = 200 mV
		3	9	—	mA	V _{IN+} = 0 V, V _{IN-} = 1 V, V _{OL} = 1 V
Output voltage	V _{OH1}	13.2	13.6	—	V	I _{OH} = -1 mA
	V _{OH2}	12.0	13.3	—	V	I _{OH} = -10 mA
Output voltage	V _{OL1}	—	0.8	1.0	V	I _{OL} = 1 mA
	V _{OL2}	—	1.1	1.8	V	I _{OL} = 10 mA

Note: 1. Design spec.

Characteristic Curves

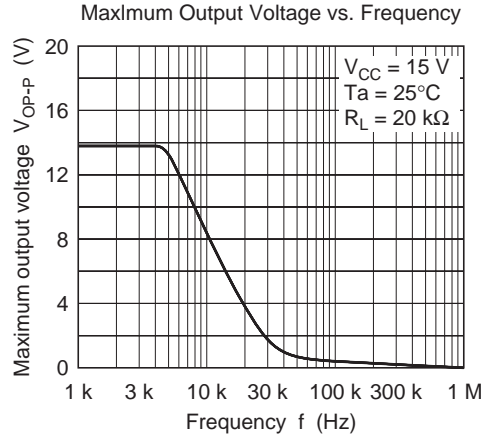
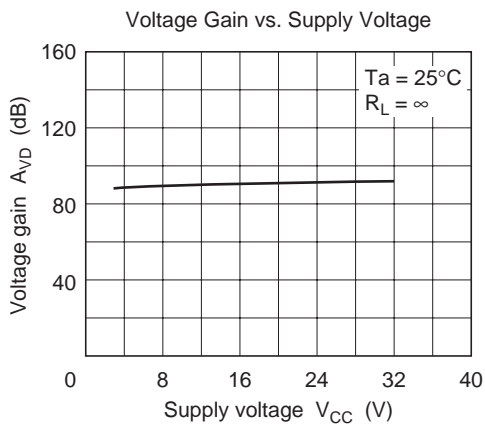
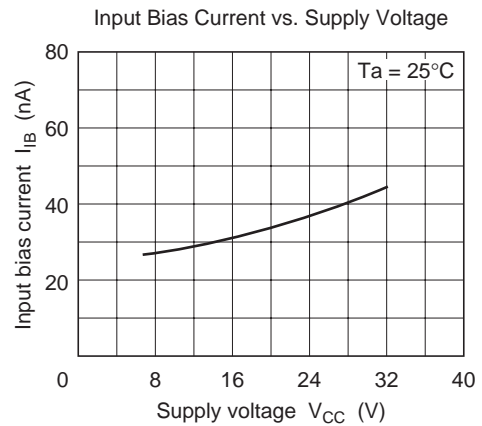
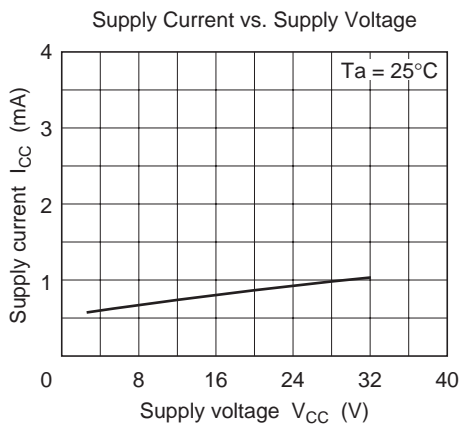
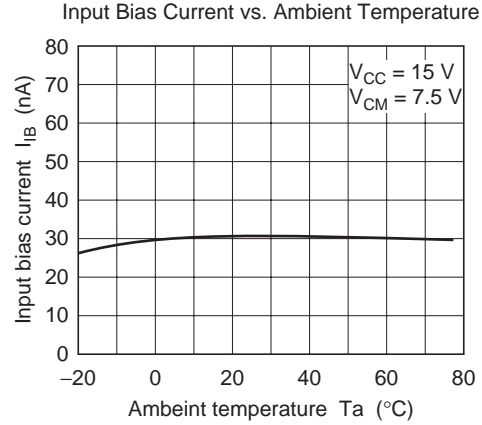
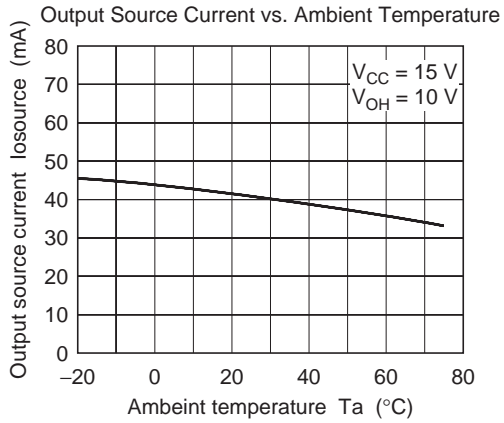

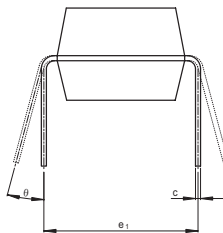
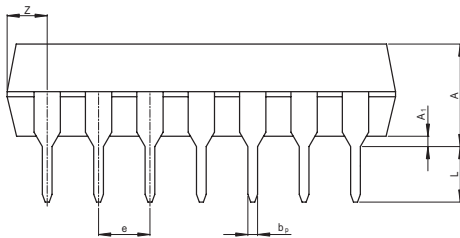
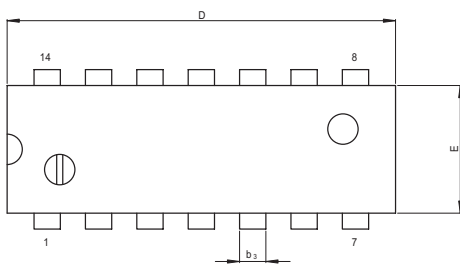
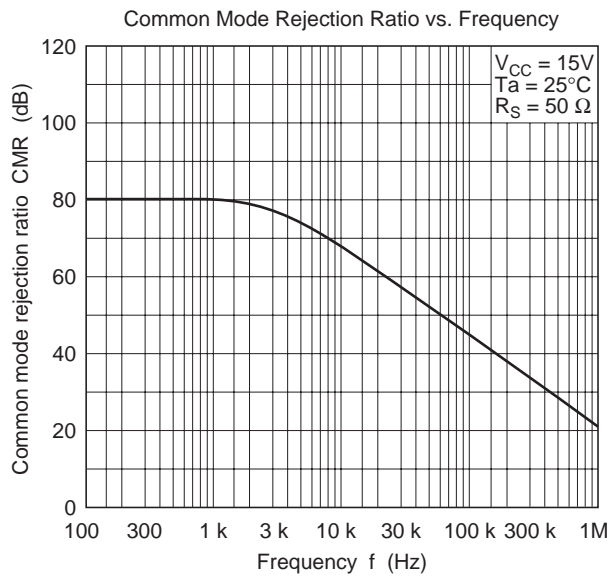
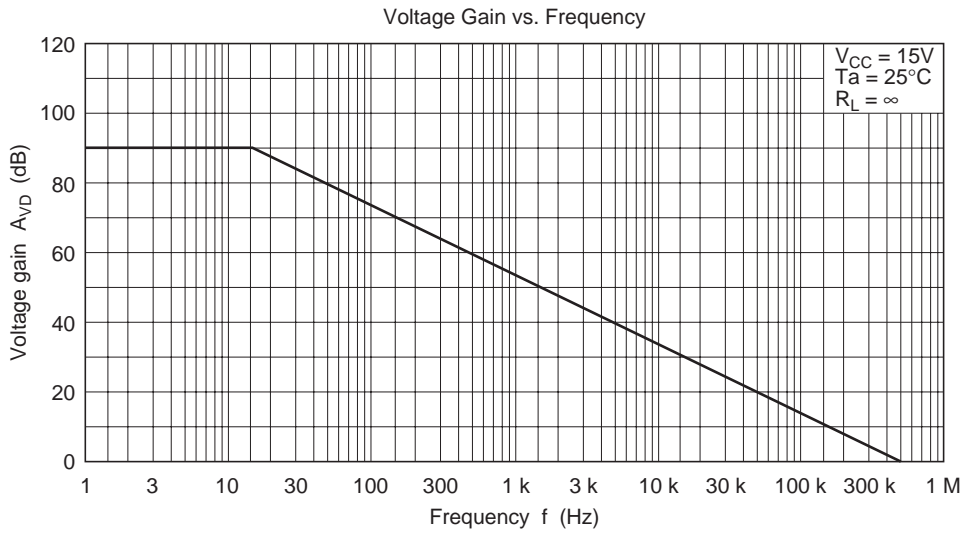

(NiPd/Au plating)

Reference Symbol	Dimension in Millimeters		
	Min	Nom	Max
e ₁	—	7.62	—
D	—	19.2	20.32
E	—	6.3	7.4
A	—	—	5.06
A ₁	0.51	—	—
b _p	0.40	0.48	0.56
b ₃	—	1.30	—
c	0.19	0.25	0.31
θ	0°	—	15°
e	2.29	2.54	2.79
Z	—	—	2.39
L	2.54	—	—

以上信息仅供参考. 如需帮助联系客服人员. 谢谢 XINLUDA