

# SAC-3P-M12MS/ 1,5-547/M12FS BK - Sensor/actuator cable



1424910

<https://www.phoenixcontact.com/us/products/1424910>

Please be informed that the data shown in this PDF document is generated from our online catalog. Please find the complete data in the user documentation. Our general terms of use for downloads are valid.



Sensor/actuator cable, 3-position, PVC, yellow, Plug straight M12, coding: A, on Socket straight M12, coding: A, cable length: 1.5 m

## Commercial data

Item number	1424910
Packing unit	1 pc
Note	Made to order (non-returnable)
Sales key	BF13
Product key	BF1IFA
GTIN	4055626401829
Weight per piece (including packing)	22.22 g
Weight per piece (excluding packing)	22.22 g
Customs tariff number	85444290
Country of origin	US

# SAC-3P-M12MS/ 1,5-547/M12FS BK - Sensor/actuator cable



1424910

<https://www.phoenixcontact.com/us/products/1424910>

## Technical data

### Product properties

Product type	Sensor/actuator cable
Number of positions	3
Application	Standard, U.S. cables
No. of cable outlets	1
Shielded	no
Coding	A

### Insulation characteristics

Overvoltage category	II
Degree of pollution	3

### Material specifications

Flammability rating according to UL 94	HB
Seal material	NBR
Material of grip body	TPU, hardly inflammable, self-extinguishing
Contact material	CuSn
Contact surface material	Ni/Au
Contact carrier material	TPU GF
Material for screw connection	Zinc die-cast, nickel-plated
Outer sheath, material	PVC

### Electrical properties

Contact resistance	$\leq 5 \text{ m}\Omega$
Insulation resistance	$\geq 10 \text{ M}\Omega$
Nominal voltage $U_N$	250 V AC
	250 V DC
Nominal current $I_N$	4 A
Protective circuit	unwired

### Signaling

Status display	No
Status display present	No

### Connection data

#### Conductor connection

Tightening torque	0.4 Nm (M12 connector)
-------------------	------------------------

### Connector

#### Connection 1

Type	Plug straight M12
------	-------------------

# SAC-3P-M12MS/ 1,5-547/M12FS BK - Sensor/actuator cable



1424910

<https://www.phoenixcontact.com/us/products/1424910>

Number of positions	3
Coding type	A
Number of positions	3

## Connection 2

Type	Socket straight M12
Number of positions	3
Coding type	A
Number of positions	3

## Cable/line

Cable length	1.5 m
--------------	-------

## PVC AWG 18 yellow 105°C [547]

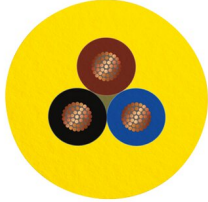
Dimensional drawing	
UL AWM Style	2517 (105 °C / 300 V)
Number of positions	3
Shielded	no
Cable type	PVC AWG 18 yellow 105°C [547]
Conductor structure signal line	41x 0.16 mm
AWG signal line	18
Wire diameter incl. insulation	1.7 mm ±0.03 mm
External cable diameter	5.7 mm ±0.2 mm
Outer sheath, material	PVC
External sheath, color	yellow
Conductor material	Tin-plated Cu litz wires
Material wire insulation	PVC
Single wire, color	brown, blue, black
Overall twist	3 wires, twisted
Nominal voltage, cable	300 V
Minimum bending radius, fixed installation	8 x D
Flame resistance	FT4
Special properties	C(UL) CMX OUTDOOR-CMG 105 °C UL ITC/PLTC 105 °C CSA AWM I/II A/B FT4 105 °C / 300 V
Ambient temperature (operation)	-30 °C ... 105 °C (cable, fixed installation)

## Environmental and real-life conditions

# SAC-3P-M12MS/ 1,5-547/M12FS BK - Sensor/actuator cable



1424910

<https://www.phoenixcontact.com/us/products/1424910>

## Ambient conditions

Degree of protection	IP65
	IP67
	IP68
Ambient temperature (operation)	-25 °C ... 90 °C (Plug / socket)

## Standards and regulations

Standard designation	M12 connector
Standards/specifications	IEC 61076-2-101

# SAC-3P-M12MS/ 1,5-547/M12FS BK - Sensor/actuator cable



1424910

<https://www.phoenixcontact.com/us/products/1424910>

## Drawings

Schematic diagram

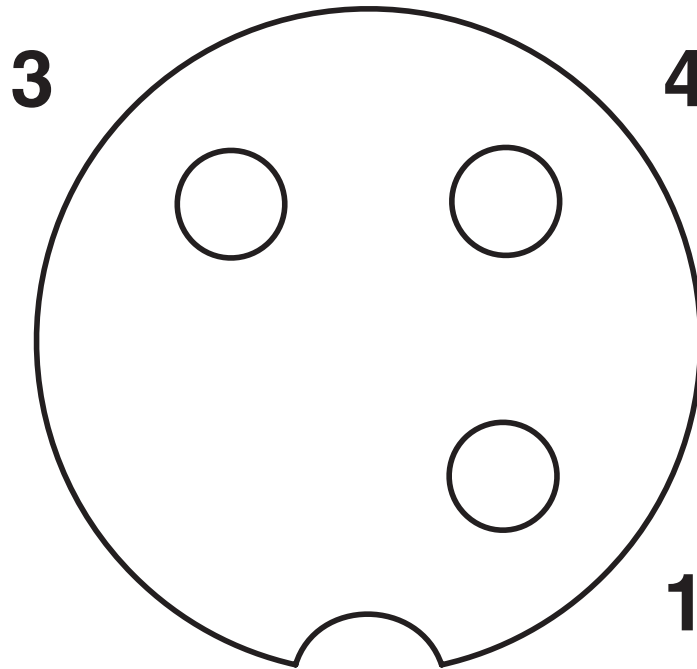

Pin assignment M12 socket, 3-pos., A-coded, view female side

Dimensional drawing

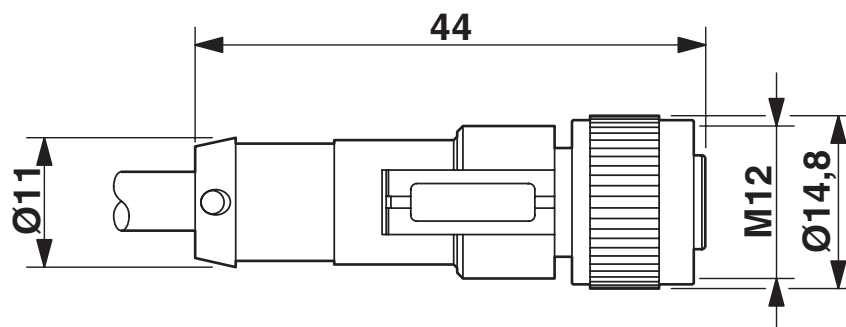

M12 x 1 socket, straight

# SAC-3P-M12MS/ 1,5-547/M12FS BK - Sensor/actuator cable



1424910

<https://www.phoenixcontact.com/us/products/1424910>

Dimensional drawing

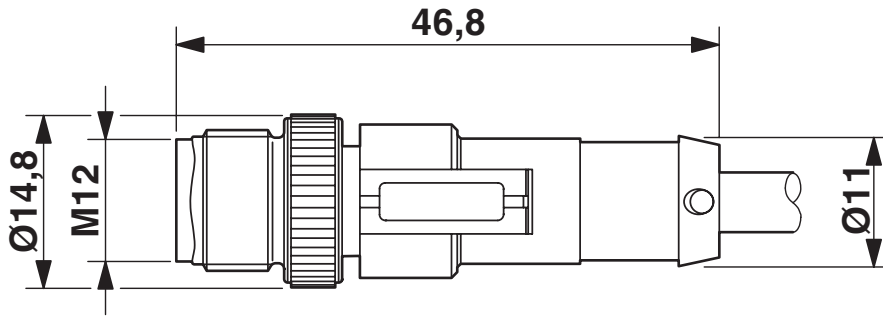

Plug, M12 x 1, straight, shielded

Schematic diagram

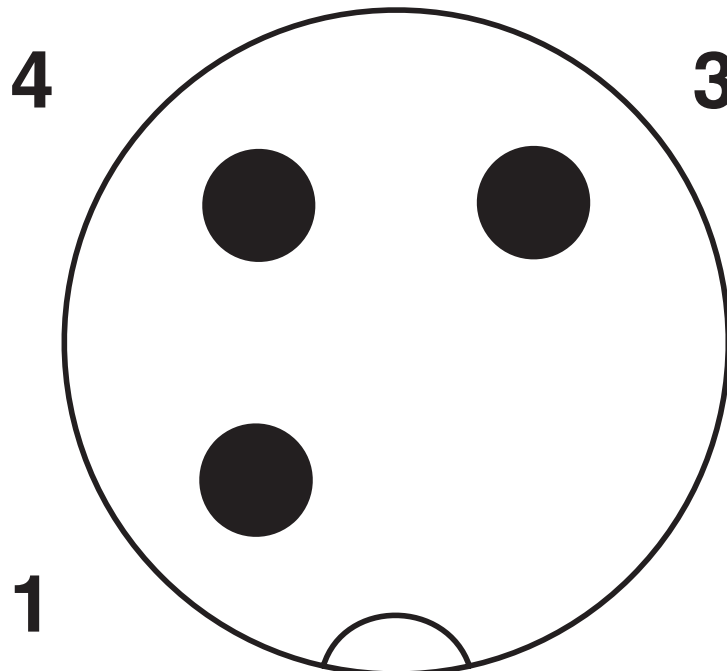

Pin assignment M12 plug, 3-pos., A-coded, view male side

# SAC-3P-M12MS/ 1,5-547/M12FS BK - Sensor/actuator cable



1424910

<https://www.phoenixcontact.com/us/products/1424910>

Circuit diagram

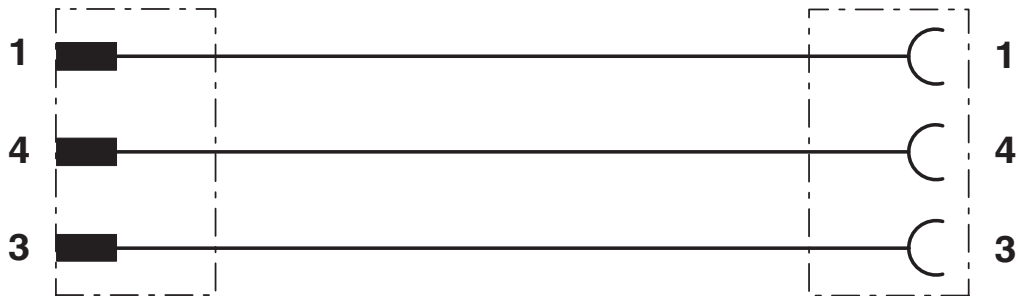

# SAC-3P-M12MS/ 1,5-547/M12FS BK - Sensor/actuator cable





1424910

<https://www.phoenixcontact.com/us/products/1424910>

## Approvals

To download certificates, visit the product detail page: <https://www.phoenixcontact.com/us/products/1424910>

 <b>UL Listed</b> Approval ID: FILE E 221474	Nominal voltage $U_N$	Nominal current $I_N$	Cross section AWG	Cross section $\text{mm}^2$
	300 V	4 A	-	-

 <b>cUL Listed</b> Approval ID: FILE E 221474	Nominal voltage $U_N$	Nominal current $I_N$	Cross section AWG	Cross section $\text{mm}^2$
	300 V	4 A	-	-

 <b>EAC-RoHS</b> Approval ID: RU D-DE.HB35.B.00387
---

<b>cULus Listed</b>
---------------------



# SAC-3P-M12MS/ 1,5-547/M12FS BK - Sensor/actuator cable



1424910

<https://www.phoenixcontact.com/us/products/1424910>

## Classifications

### ECLASS

ECLASS-11.0	27060311
ECLASS-12.0	27060311
ECLASS-13.0	27060311

### ETIM

ETIM 8.0	EC001855
----------	----------

### UNSPSC

UNSPSC 21.0	26121600
-------------	----------

# SAC-3P-M12MS/ 1,5-547/M12FS BK - Sensor/actuator cable



1424910

<https://www.phoenixcontact.com/us/products/1424910>

## Environmental product compliance

China RoHS	Environmentally Friendly Use Period = 50 years
	For information on hazardous substances, refer to the manufacturer's declaration available under "Downloads"

# SAC-3P-M12MS/ 1,5-547/M12FS BK - Sensor/actuator cable



1424910

<https://www.phoenixcontact.com/us/products/1424910>

## Accessories

### PROT-M12 FS-PA-CHAIN - Sealing cap

1430873

<https://www.phoenixcontact.com/us/products/1430873>

M12 sealing cap made of plastic with fixing band, for sensor cables, for free M12 plugs



### SAC-M12-EXCLIP-M - Locking clip

1558988

<https://www.phoenixcontact.com/us/products/1558988>

Locking clip for the pin side of sensor/actuator cables with M12 connector and M12 connectors for assembly, for knurl diameter: 15 mm or for Allen key with a wrench size of 14 mm, prevents the disconnection of plug-in connections without tools



# SAC-3P-M12MS/ 1,5-547/M12FS BK - Sensor/actuator cable



1424910

<https://www.phoenixcontact.com/us/products/1424910>

## PROT-M12 MS-PA-CHAIN - Screw plug

1430899

<https://www.phoenixcontact.com/us/products/1430899>

M12 sealing cap with fixing band, for sensor cables, for free M12 sockets



---

## SAC-M12-EXCLIP-F - Locking clip

1558991

<https://www.phoenixcontact.com/us/products/1558991>

Locking clip for the socket side of sensor/actuator cables with M12 connector and M12 connectors for assembly, for knurl diameter: 15 mm or for Allen key with a wrench size of 14 mm, prevents the disconnection of plug-in connections without tools



# SAC-3P-M12MS/ 1,5-547/M12FS BK - Sensor/actuator cable



1424910

<https://www.phoenixcontact.com/us/products/1424910>

## TSD 04 SAC - Torque screwdriver

1208429

<https://www.phoenixcontact.com/us/products/1208429>



Torque screwdriver, with preset torque of 0.4 Nm and 4 mm hexagonal drive for M12 connectors

---

## TSD-M 1,2NM - Torque screwdriver

1212224

<https://www.phoenixcontact.com/us/products/1212224>



Torque screw driver, accuracy as per EN ISO 6789 standard, adjustable from 0.3 - 1.2 Nm

# SAC-3P-M12MS/ 1,5-547/M12FS BK - Sensor/actuator cable



1424910

<https://www.phoenixcontact.com/us/products/1424910>

## TSD-M SAC-BIT ADAPTER - Adapter insert

1212600

<https://www.phoenixcontact.com/us/products/1212600>



Adapter bit for TSD-M...torque tools, E6.3-1/4" drive with 4 mm hexagon to accommodate SAC bits

## SAC BIT M12-D15 - Tool

1208432

<https://www.phoenixcontact.com/us/products/1208432>



Nut for assembling sensor/actuator cables with M12 connector and M12 connectors for assembly, with a knurl diameter of 15 mm, for 4 mm hexagonal drive

Phoenix Contact 2023 © - all rights reserved  
<https://www.phoenixcontact.com>

Phoenix Contact USA  
586 Fulling Mill Road  
Middletown, PA 17057, United States  
(+717) 944-1300  
[info@phoenixcon.com](mailto:info@phoenixcon.com)