

Features

- Planar Die Construction
- Zener Voltages from 2.4V - 75V
- Ideally Suited for Automated Assembly Processes
- Halogen Free. "Green" Device (Note 1)
- Moisture Sensitivity Level 1
- Epoxy Meets UL 94 V-0 Flammability Rating
- Lead Free Finish/RoHS Compliant ("P" Suffix Designates RoHS Compliant. See Ordering Information)

Maximum Ratings

- Operating Junction Temperature Range: -55°C to +150°C
- Storage Temperature Range: -55°C to +150°C
- Thermal Resistance: 357°C/W Junction to Ambient

Parameter	Symbol	Rating	Conditions
Power Dissipation	P_D	350mW	Note 3
Peak Forward Surge Current	I_{FSM}	2.0A	Note 4
Maximum Forward Voltage	V_F	0.9V	$I_F=10mA$

Note: 1. Halogen free "Green" products are defined as those which contain <900ppm bromine, <900ppm chlorine (<1500ppm total Br + Cl) and <1000ppm antimony compounds.

2. Mounted on 5.0mm² (.013mm thick) Land Areas.

3. Measured on 8.3ms, Single Half Sine-wave or Equivalent Square Wave

Internal Structure and Marking Code

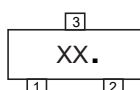
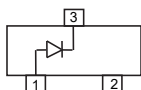

XX: Marking Code
'.' : Product Line

350 mWatt Zener Diodes 2.4 to 75 Volts

SOT-23

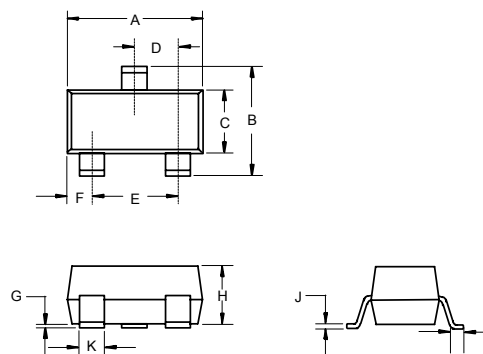

DIM	INCHES		MM		NOTE
	MIN	MAX	MIN	MAX	
A	0.110	0.120	2.80	3.04	
B	0.083	0.104	2.10	2.64	
C	0.047	0.055	1.20	1.40	
D	0.034	0.041	0.85	1.05	
E	0.067	0.083	1.70	2.10	
F	0.018	0.024	0.45	0.60	
G	0.0004	0.006	0.01	0.15	
H	0.035	0.043	0.90	1.10	
J	0.003	0.007	0.08	0.18	
K	0.012	0.020	0.30	0.51	
L	0.007	0.020	0.20	0.50	

Suggested Solder Pad Layout

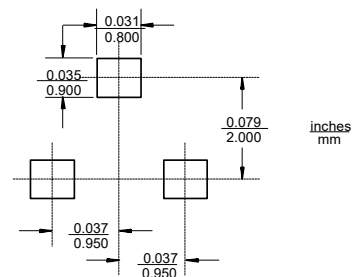

Electrical Characteristics @ 25°C Unless Otherwise Specified

MCC Part Number	Zener Voltage ^(4,5)			Maximum Zener Impedance ⁽⁶⁾				Maximum Reverse Current $I_R @ V_R$		Typical Temperature Coefficient $mV/°C$		Marking Code
	$V_Z @ I_{ZT}$			I_{ZT}	$Z_{ZT} @ I_{ZT}$	I_{ZK}	$Z_{ZK} @ I_{ZK}$	I_R	V_R	$T_C @ I_{ZTC}$		
	Min.(V)	Nom(V)	Max.(V)	mA	Ω	mA	Ω	μA	V	min.	max.	
BZX84C2V4	2.28	2.40	2.52	5	100	1	600	50	1.0	-3.5	0	Z11
BZX84C2V7	2.50	2.70	2.90	5	100	1	600	20	1.0	-3.5	0	W2
BZX84C3V0	2.80	3.00	3.20	5	95	1	600	10	1.0	-3.5	0	Z13
BZX84C3V3	3.10	3.30	3.50	5	95	1	600	5	1.0	-3.5	0	Z14
BZX84C3V6	3.40	3.60	3.80	5	90	1	600	5	1.0	-3.5	0	Z15
BZX84C3V9	3.70	3.90	4.10	5	90	1	600	3	1.0	-3.5	0	Z16
BZX84C4V3	4.00	4.30	4.60	5	90	1	600	3	1.0	-3.5	0	Z17
BZX84C4V7	4.40	4.70	5.00	5	80	1	500	3	2.0	-3.5	0	Z1.
BZX84C5V1	4.80	5.10	5.40	5	60	1	480	2	2.0	-2.7	1.2	Z2
BZX84C5V6	5.20	5.60	6.00	5	40	1	400	1	2.0	-2.0	2.5	Z3
BZX84C6V2	5.80	6.20	6.60	5	10	1	150	3	4.0	0.4	3.7	Z4
BZX84C6V8	6.40	6.80	7.20	5	15	1	80	2	4.0	1.2	4.5	Z5
BZX84C7V5	7.00	7.50	7.90	5	15	1	80	1	5.0	2.5	5.3	Z6
BZX84C8V2	7.70	8.20	8.70	5	15	1	80	0.7	5.0	3.2	6.2	Z7
BZX84C9V1	8.50	9.10	9.60	5	15	1	100	0.5	6.0	3.8	7.0	Z8
BZX84C10	9.40	10.00	10.60	5	20	1	150	0.2	7.0	4.5	8.0	Z9
BZX84C11	10.40	11.00	11.60	5	20	1	150	0.1	8.0	5.4	9.0	Y1
BZX84C12	11.40	12.00	12.70	5	25	1	150	0.1	8.0	6.0	10.0	Y2
BZX84C13	12.40	13.00	14.10	5	30	1	170	0.1	8.0	7.0	11.0	Y3
BZX84C15	13.80	15.00	15.60	5	30	1	200	0.1	10.5	9.2	13.0	Y4
BZX84C16	15.30	16.00	17.10	5	40	1	200	0.1	11.2	10.4	14.0	Y5
BZX84C18	16.80	18.00	19.10	5	45	1	225	0.1	12.6	12.4	16.0	Y6
BZX84C20	18.80	20.00	21.20	5	55	1	225	0.1	14.0	14.4	18.0	Y7
BZX84C22	20.80	22.00	23.30	5	55	1	250	0.1	15.4	16.4	20.0	Y8
BZX84C24	22.80	24.00	25.60	5	70	1	250	0.1	16.8	18.4	22.0	Y9
BZX84C27	25.10	27.00	28.90	2	80	0.5	300	0.1	18.9	21.4	25.3	Y10
BZX84C30	28.00	30.00	32.00	2	80	0.5	300	0.1	21.0	24.4	29.4	Y11
BZX84C33	31.00	33.00	35.00	2	80	0.5	325	0.1	23.1	27.4	33.4	Y12
BZX84C36	34.00	36.00	38.00	2	90	0.5	350	0.1	25.2	30.4	37.4	Y13.
BZX84C39	37.00	39.00	41.00	2	130	0.5	350	0.1	27.3	33.4	41.2	Y14
BZX84C43	40.85	43.00	45.15	2	150	0.5	375	0.1	30.1	37.6	46.6	Y15
BZX84C47	44.65	47.00	49.35	2	170	0.5	375	0.1	32.9	42.0	51.8	Y16
BZX84C51	48.45	51.00	53.55	2	180	0.5	400	0.1	35.7	46.6	57.2	Y17
BZX84C56	53.20	56.00	58.80	2	200	0.5	425	0.05	39.2	52.2	63.8	Y18
BZX84C62	58.90	62.00	65.10	2	215	0.5	450	0.05	43.4	58.8	71.6	Y19
BZX84C68	64.60	68.00	71.40	2	240	0.5	475	0.05	47.6	65.6	79.8	Y20
BZX84C75	71.25	75.00	78.75	2	255	0.5	500	0.05	52.5	73.4	88.6	Y21

Note :

- Standard zener voltage tolerance is +/- 5% with a 'C' suffix from BZX84C2V4~BZX84C75 , suffix 'B' is +/- 2% tolerance from BZX84B2V4~BZX84B75.
- Zener Voltage (V_Z) Measurement. Guarantess the Zener Voltage When Measured at 90 Seconds While Maintaining the Lead Temperature (T_L) at 25°C from the Diode Body.
- Zener Impedance (Z_Z) Derivation. The zener Impedance is Derived from the 60 Cycle AC Voltage, Which Results When an AC Current Having an rms Value Equal to 10% of the DC Zener Current (I_{ZT} or I_{ZK}) is Superimposed on I_{ZT} or I_{ZK} .

Electrical Characteristics @ 25°C Unless Otherwise Specified

MCC Part Number	Zener Voltage ^(4,5)			Maximum Zener Impedance ⁽⁶⁾				Maximum Reverse Current $I_R @ V_R$		Typical Temperature Coefficient mV/°C		Marking Code
	$V_Z @ I_{ZT}$			I_{ZT}	$Z_{ZT} @ I_{ZT}$	I_{ZK}	$Z_{ZK} @ I_{ZK}$	I_R	V_R	$T_C @ I_{ZTC}$		
	Min.(V)	Nom(V)	Max.(V)	mA	Ω	mA	Ω	μA	V	min.	max.	
BZX84B2V4	2.35	2.40	2.45	5	100	1	600	50	1.0	-3.5	0	W1
BZX84B2V7	2.65	2.70	2.75	5	100	1	600	20	1.0	-3.5	0	W2
BZX84B3V0	2.94	3.00	3.06	5	95	1	600	10	1.0	-3.5	0	W3
BZX84B3V3	3.23	3.30	3.37	5	95	1	600	5	1.0	-3.5	0	W4
BZX84B3V6	3.53	3.60	3.67	5	90	1	600	5	1.0	-3.5	0	W5
BZX84B3V9	3.82	3.90	3.98	5	90	1	600	3	1.0	-3.5	0	W6
BZX84B4V3	4.21	4.30	4.39	5	90	1	600	3	1.0	-3.5	0	W7
BZX84B4V7	4.61	4.70	4.79	5	80	1	500	3	2.0	-3.5	0	Z1
BZX84B5V1	5.00	5.10	5.20	5	60	1	480	2	2.0	-2.7	1.2	Z22
BZX84B5V6	5.49	5.60	5.71	5	40	1	400	1	2.0	-2.0	2.5	Z23
BZX84B6V2	6.08	6.20	6.32	5	10	1	150	3	4.0	0.4	3.7	Z24
BZX84B6V8	6.66	6.80	6.94	5	15	1	80	2	4.0	1.2	4.5	Z25
BZX84B7V5	7.35	7.50	7.65	5	15	1	80	1	5.0	2.5	5.3	Z26
BZX84B8V2	8.04	8.20	8.36	5	15	1	80	0.7	5.0	3.2	6.2	Z27
BZX84B9V1	8.92	9.10	9.28	5	15	1	100	0.5	6.0	3.8	7.0	Z28
BZX84B10	9.80	10.00	10.20	5	20	1	150	0.2	7.0	4.5	8.0	Z29
BZX84B11	10.78	11.00	11.22	5	20	1	150	0.1	8.0	5.4	9.0	WH
BZX84B12	11.76	12.00	12.24	5	25	1	150	0.1	8.0	6.0	10.0	2Y2
BZX84B13	12.74	13.00	13.26	5	30	1	170	0.1	8.0	7.0	11.0	2Y3
BZX84B15	14.70	15.00	15.30	5	30	1	200	0.1	10.5	9.2	13.0	2Y4
BZX84B16	15.68	16.00	16.32	5	40	1	200	0.1	11.2	10.4	14.0	2Y5
BZX84B18	17.64	18.00	18.36	5	45	1	225	0.1	12.6	12.4	16.0	2Y6
BZX84B20	19.60	20.00	20.40	5	55	1	225	0.1	14.0	14.4	18.0	WO
BZX84B22	21.56	22.00	22.44	5	55	1	250	0.1	15.4	16.4	20.0	WP
BZX84B24	23.52	24.00	24.48	5	70	1	250	0.1	16.8	18.4	22.0	WR
BZX84B27	26.46	27.00	27.54	2	80	0.5	300	0.1	18.9	21.4	25.3	WS
BZX84B30	29.40	30.00	30.60	2	80	0.5	300	0.1	21.0	24.4	29.4	WT
BZX84B33	32.34	33.00	33.66	2	80	0.5	325	0.1	23.1	27.4	33.4	WU
BZX84B36	35.28	36.00	36.72	2	90	0.5	350	0.1	25.2	30.4	37.4	Y13
BZX84B39	38.22	39.00	39.78	2	130	0.5	350	0.1	27.3	33.4	41.2	WX
BZX84B43	42.14	43.00	43.86	2	150	0.5	375	0.1	30.1	37.6	46.6	WY
BZX84B47	45.83	47.00	48.17	2	170	0.5	375	0.1	32.9	42.0	51.8	WZ
BZX84B51	49.73	51.00	52.27	2	180	0.5	400	0.1	35.7	46.6	57.2	XA
BZX84B56	54.60	56.00	57.40	2	200	0.5	425	0.05	39.2	52.2	63.8	XB
BZX84B62	60.45	62.00	63.55	2	215	0.5	450	0.05	43.4	58.8	71.6	XC
BZX84B68	66.30	68.00	69.70	2	240	0.5	475	0.05	47.6	65.6	79.8	XD
BZX84B75	73.13	75.00	76.87	2	255	0.5	500	0.05	52.5	73.4	88.6	XE

Note :

- Standard zener voltage tolerance is +/- 5% with a 'C' suffix, suffix 'B' is +/- 2% tolerance.
- Zener Voltage (V_Z) Measurement. Guarantess the Zener Voltage When Measured at 90 Seconds While Maintaining the Lead Temperature (T_L) at 25°C from the Diode Body.
- Zener Impedance (Z_Z) Derivation. The zener Impedance is Derived from the 60 Cycle AC Voltage, Which Results When an AC Current Having an rms Value Equal to 10% of the DC Zener Current (I_{ZT} or I_{ZK}) is Superimposed on I_{ZT} or I_{ZK} .

Curve Characteristics

Fig. 1 - Power Derating Curve

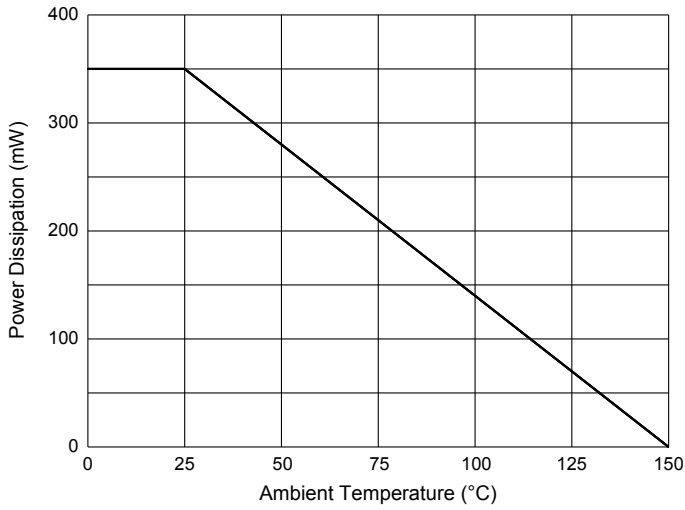

Fig. 2 - Typical Forward Characteristics

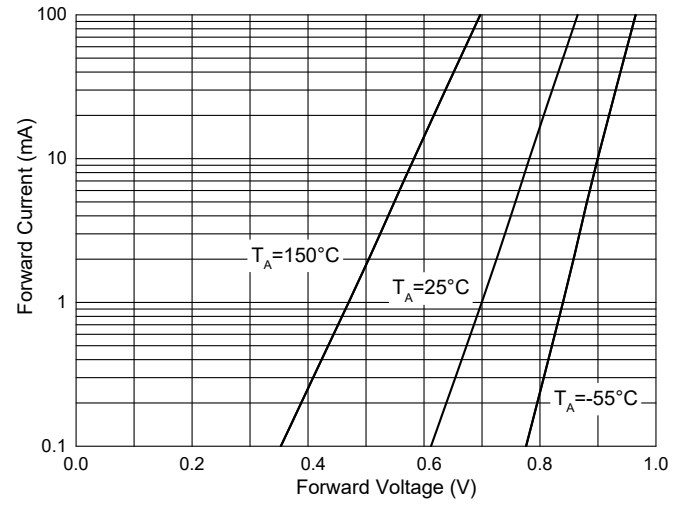

Fig. 3 - Typical Zener Breakdown Characteristics

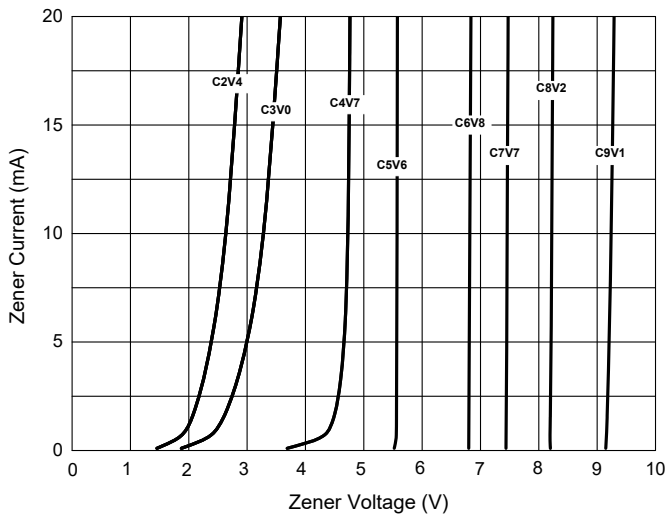
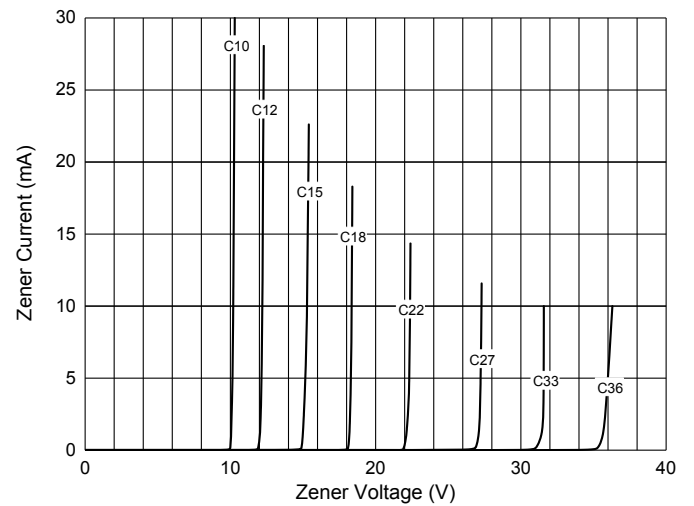

Fig. 4 - Typical Zener Breakdown Characteristics



Ordering Information

Device	Packing
Part Number-TP	Tape&Reel:3Kpcs/Reel

IMPORTANT NOTICE

Micro Commercial Components Corp. reserves the right to make changes without further notice to any product herein to make corrections, modifications, enhancements, improvements, or other changes. **Micro Commercial Components Corp.** does not assume any liability arising out of the application or use of any product described herein; neither does it convey any license under its patent rights, nor the rights of others. The user of products in such applications shall assume all risks of such use and will agree to hold **Micro Commercial Components Corp.** and all the companies whose products are represented on our website, harmless against all damages. **Micro Commercial Components Corp.** products are sold subject to the general terms and conditions of commercial sale, as published at <https://www.mccsemi.com/Home/TermsAndConditions>.

LIFE SUPPORT

MCC's products are not authorized for use as critical components in life support devices or systems without the express written approval of Micro Commercial Components Corporation.

CUSTOMER AWARENESS

Counterfeiting of semiconductor parts is a growing problem in the industry. Micro Commercial Components (MCC) is taking strong measures to protect ourselves and our customers from the proliferation of counterfeit parts. MCC strongly encourages customers to purchase MCC parts either directly from MCC or from Authorized MCC Distributors who are listed by country on our web page cited below. Products customers buy either from MCC directly or from Authorized MCC Distributors are genuine parts, have full traceability, meet MCC's quality standards for handling and storage. **MCC will not provide any warranty coverage or other assistance for parts bought from Unauthorized Sources.** MCC is committed to combat this global problem and encourage our customers to do their part in stopping this practice by buying direct or from authorized distributors.