

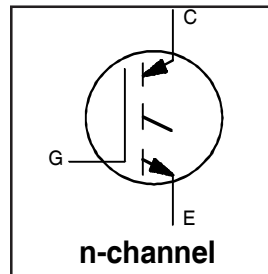
# IRG4BC40KPbF

Short Circuit Rated  
 UltraFast IGBT

## INSULATED GATE BIPOLAR TRANSISTOR

### Features

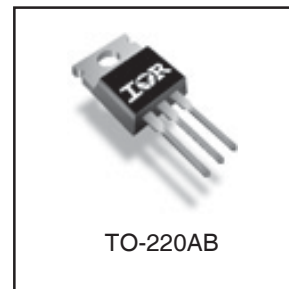
- Short Circuit Rated UltraFast: optimized for high operating frequencies >5.0KHz , and Short Circuit Rated to 10 $\mu$ s @ 125°C,  $V_{GE} = 15V$
- Generation 4 IGBT design provides higher efficiency than Generation 3
- Industry standard TO-247AC package
- Lead-Free



|                             |
|-----------------------------|
| $V_{CES} = 600V$            |
| $V_{CE(on) typ.} = 2.1V$    |
| @ $V_{GE} = 15V, I_C = 25A$ |

### Benefits

- Generation 4 IGBTs offer highest efficiency available
- IGBTs optimized for specified application conditions



### Absolute Maximum Ratings

|                           | Parameter                          | Max.                              | Units      |
|---------------------------|------------------------------------|-----------------------------------|------------|
| $V_{CES}$                 | Collector-to-Emitter Voltage       | 600                               | V          |
| $I_C @ T_C = 25^\circ C$  | Continuous Collector Current       | 42                                | A          |
| $I_C @ T_C = 100^\circ C$ | Continuous Collector Current       | 25                                |            |
| $I_{CM}$                  | Pulsed Collector Current ①         | 84                                |            |
| $I_{LM}$                  | Clamped Inductive Load Current ②   | 84                                |            |
| $t_{sc}$                  | Short Circuit Withstand Time       | 10                                | $\mu$ s    |
| $V_{GE}$                  | Gate-to-Emitter Voltage            | $\pm 20$                          | V          |
| $E_{ARV}$                 | Reverse Voltage Avalanche Energy ③ | 15                                | mJ         |
| $P_D @ T_C = 25^\circ C$  | Maximum Power Dissipation          | 160                               | W          |
| $P_D @ T_C = 100^\circ C$ | Maximum Power Dissipation          | 65                                |            |
| $T_J$                     | Operating Junction and             | -55 to +150                       | $^\circ C$ |
| $T_{STG}$                 | Storage Temperature Range          |                                   |            |
|                           | Soldering Temperature, for 10 sec. | 300 (0.063 in. (1.6mm) from case) |            |
|                           | Mounting torque, 6-32 or M3 screw. | 10 lbf·in (1.1N·m)                |            |

### Thermal Resistance

|                 | Parameter                                 | Typ.     | Max. | Units        |
|-----------------|---|----------|------|--------------|
| $R_{\theta JC}$ | Junction-to-Case                          | ---      | 0.77 | $^\circ C/W$ |
| $R_{\theta CS}$ | Case-to-Sink, Flat, Greased Surface       | 0.50     | ---  |              |
| $R_{\theta JA}$ | Junction-to-Ambient, typical socket mount | ---      | 80   |              |
| Wt              | Weight                                    | 2 (0.07) | ---  | g (oz)       |

## Electrical Characteristics @ $T_J = 25^\circ\text{C}$ (unless otherwise specified)

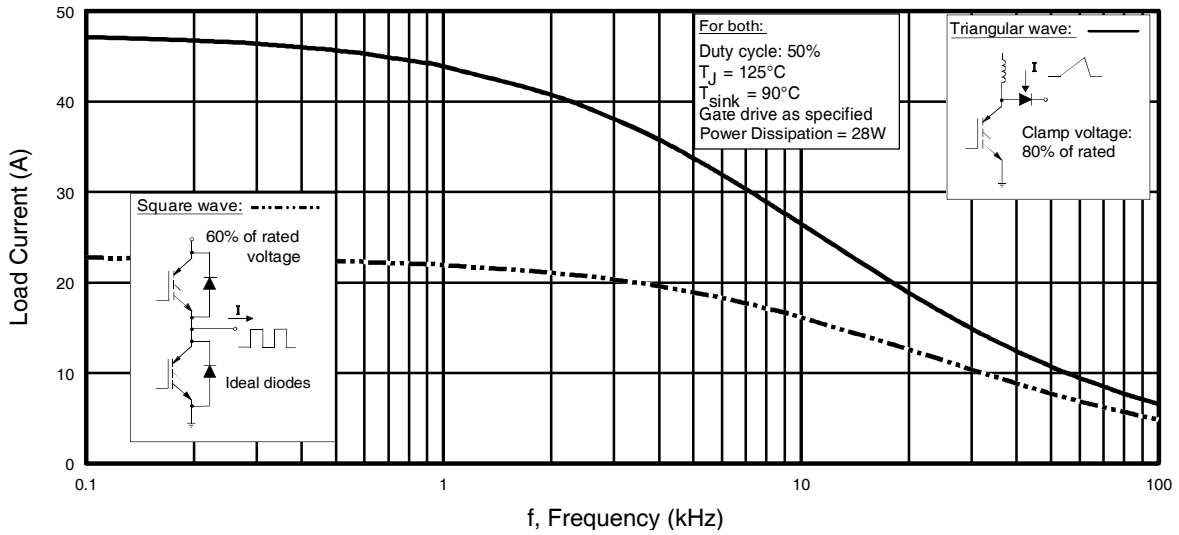
|                                 | Parameter                                | Min. | Typ. | Max.      | Units   | Conditions   |
|---------------------------------|--|------|------|-----------|---------|--|
| $V_{(BR)CES}$                   | Collector-to-Emitter Breakdown Voltage   | 600  | —    | —         | V       | $V_{GE} = 0V, I_C = 250\mu A$  |
| $V_{(BR)ECS}$                   | Emitter-to-Collector Breakdown Voltage ① | 18   | —    | —         | V       | $V_{GE} = 0V, I_C = 1.0A$  |
| $\Delta V_{(BR)CES}/\Delta T_J$ | Temperature Coeff. of Breakdown Voltage  | —    | 0.46 | —         | V/°C    | $V_{GE} = 0V, I_C = 1.0mA$   |
| $V_{CE(ON)}$                    | Collector-to-Emitter Saturation Voltage  | —    | 2.10 | 2.6       | V       | $I_C = 25A$ <span style="float:right"><math>V_{GE} = 15V</math></span> |
|                                 |  | —    | 2.70 | —         |         | $I_C = 42A$ <span style="float:right">See Fig.2, 5</span>              |
|                                 |  | —    | 2.14 | —         |         | $I_C = 25A, T_J = 150^\circ\text{C}$                                   |
| $V_{GE(th)}$                    | Gate Threshold Voltage                   | 3.0  | —    | 6.0       |         | $V_{CE} = V_{GE}, I_C = 250\mu A$                                      |
| $\Delta V_{GE(th)}/\Delta T_J$  | Temperature Coeff. of Threshold Voltage  | —    | -13  | —         | mV/°C   | $V_{CE} = V_{GE}, I_C = 250\mu A$                                      |
| $g_{fe}$                        | Forward Transconductance ②               | 7.0  | 14   | —         | S       | $V_{CE} = 100V, I_C = 25A$   |
| $I_{CES}$                       | Zero Gate Voltage Collector Current      | —    | —    | 250       | $\mu A$ | $V_{GE} = 0V, V_{CE} = 600V$   |
|                                 |  | —    | —    | 2.0       |         | $V_{GE} = 0V, V_{CE} = 10V, T_J = 25^\circ\text{C}$                    |
|                                 |  | —    | —    | 2000      |         | $V_{GE} = 0V, V_{CE} = 600V, T_J = 150^\circ\text{C}$                  |
| $I_{GES}$                       | Gate-to-Emitter Leakage Current          | —    | —    | $\pm 100$ | nA      | $V_{GE} = \pm 20V$   |

## Switching Characteristics @ $T_J = 25^\circ\text{C}$ (unless otherwise specified)

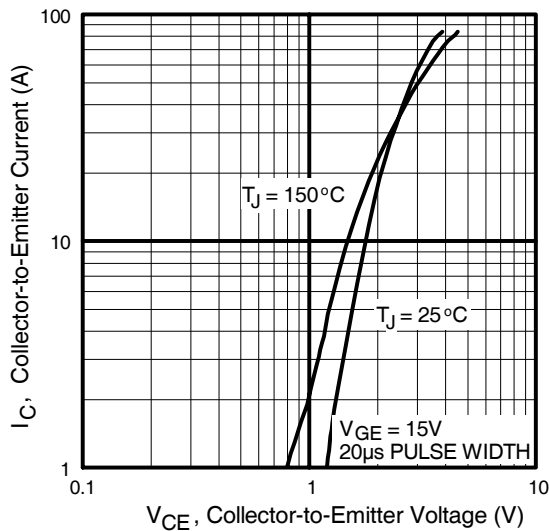
|              | Parameter                         | Min. | Typ. | Max. | Units   | Conditions  |
|--------------|-----------------------------------|------|------|------|---------|---|
| $Q_g$        | Total Gate Charge (turn-on)       | —    | 120  | 180  | nC      | $I_C = 25A$   |
| $Q_{ge}$     | Gate - Emitter Charge (turn-on)   | —    | 16   | 24   |         | $V_{CC} = 400V$ <span style="float:right">See Fig.8</span>  |
| $Q_{gc}$     | Gate - Collector Charge (turn-on) | —    | 51   | 77   |         | $V_{GE} = 15V$  |
| $t_{d(on)}$  | Turn-On Delay Time                | —    | 30   | —    | ns      | $T_J = 25^\circ\text{C}$<br>$I_C = 25A, V_{CC} = 480V$<br>$V_{GE} = 15V, R_G = 10\Omega$  |
| $t_r$        | Rise Time                         | —    | 15   | —    |         |   |
| $t_{d(off)}$ | Turn-Off Delay Time               | —    | 140  | 210  |         |   |
| $t_f$        | Fall Time                         | —    | 140  | 210  |         |   |
| $E_{on}$     | Turn-On Switching Loss            | —    | 0.62 | —    | mJ      | Energy losses include "tail"<br>See Fig. 9,10,14  |
| $E_{off}$    | Turn-Off Switching Loss           | —    | 0.33 | —    |         |   |
| $E_{ts}$     | Total Switching Loss              | —    | 0.95 | 1.4  |         |   |
| $t_{sc}$     | Short Circuit Withstand Time      | 10   | —    | —    | $\mu s$ | $V_{CC} = 400V, T_J = 125^\circ\text{C}$<br>$V_{GE} = 15V, R_G = 10\Omega, V_{CPK} < 500V$  |
| $t_{d(on)}$  | Turn-On Delay Time                | —    | 30   | —    | ns      | $T_J = 150^\circ\text{C}$ ,<br>$I_C = 25A, V_{CC} = 480V$<br>$V_{GE} = 15V, R_G = 10\Omega$<br>Energy losses include "tail"<br>See Fig. 11,14 |
| $t_r$        | Rise Time                         | —    | 18   | —    |         |   |
| $t_{d(off)}$ | Turn-Off Delay Time               | —    | 190  | —    |         |   |
| $t_f$        | Fall Time                         | —    | 150  | —    |         |   |
| $E_{ts}$     | Total Switching Loss              | —    | 1.9  | —    | mJ      |   |
| $L_E$        | Internal Emitter Inductance       | —    | 13   | —    | nH      | Measured 5mm from package   |
| $C_{ies}$    | Input Capacitance                 | —    | 1600 | —    | pF      | $V_{GE} = 0V$<br>$V_{CC} = 30V$ <span style="float:right">See Fig. 7</span><br>$f = 1.0MHz$   |
| $C_{oes}$    | Output Capacitance                | —    | 130  | —    |         |   |
| $C_{res}$    | Reverse Transfer Capacitance      | —    | 55   | —    |         |   |

### Notes:

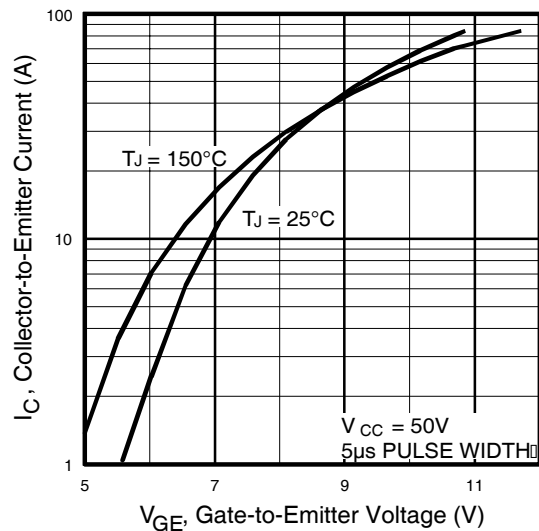
- |  |   |
|--|---|
| ① Repetitive rating; $V_{GE} = 20V$ , pulse width limited by max. junction temperature. ( See fig. 13b ) | ③ Repetitive rating; pulse width limited by maximum junction temperature. |
| ② $V_{CC} = 80\%(V_{CES})$ , $V_{GE} = 20V$ , $L = 10\mu H$ , $R_G = 10\Omega$ , (See fig. 13a)          | ④ Pulse width $\leq 80\mu s$ ; duty factor $\leq 0.1\%$ .                 |
|  | ⑤ Pulse width $5.0\mu s$ , single shot.                                   |



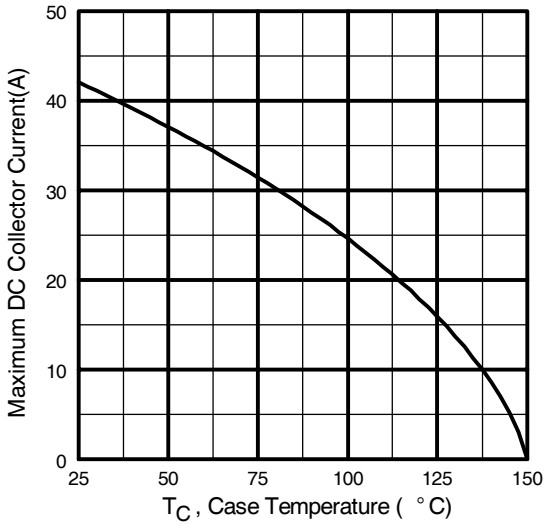
**Fig. 1 - Typical Load Current vs. Frequency**  
(Load Current =  $I_{RMS}$  of fundamental)



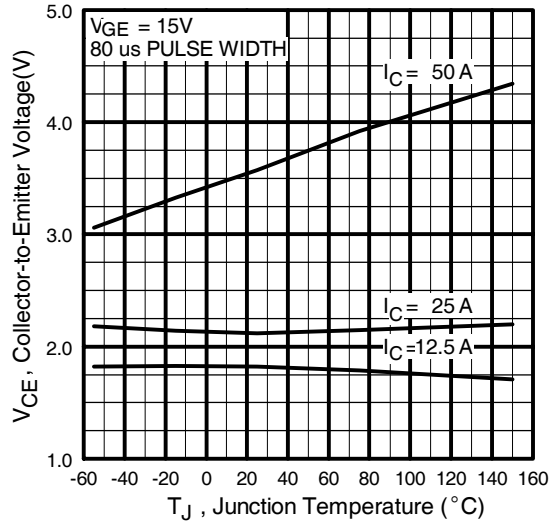
**Fig. 2 - Typical Output Characteristics**



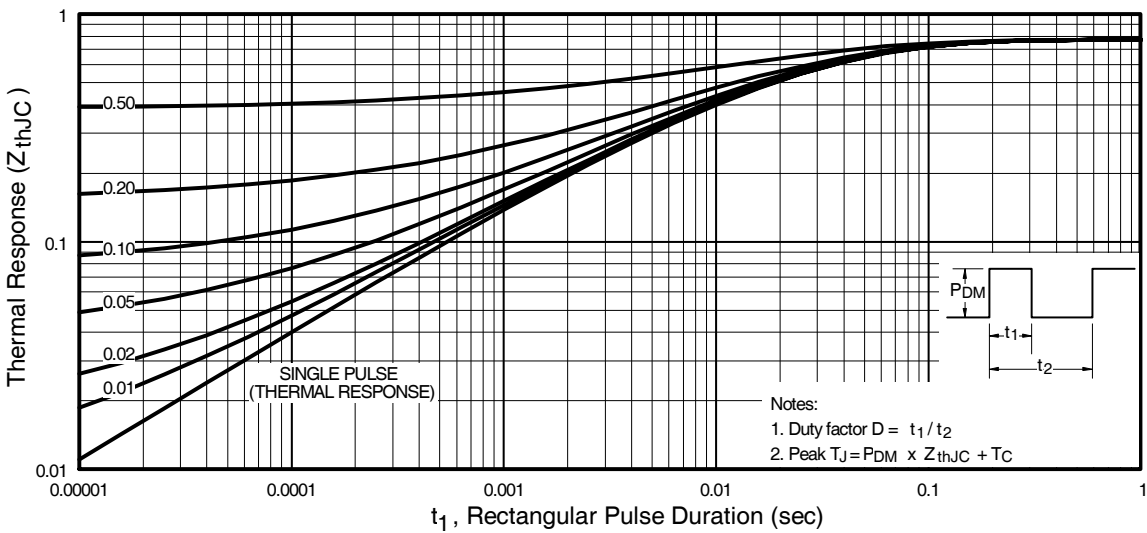
**Fig. 3 - Typical Transfer Characteristics**



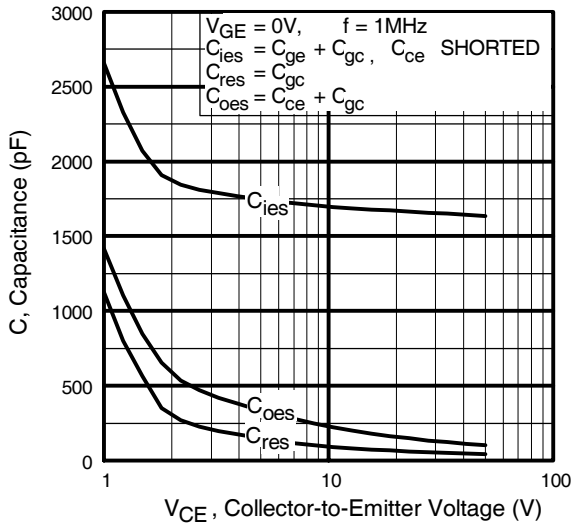
**Fig. 4** - Maximum Collector Current vs. Case Temperature



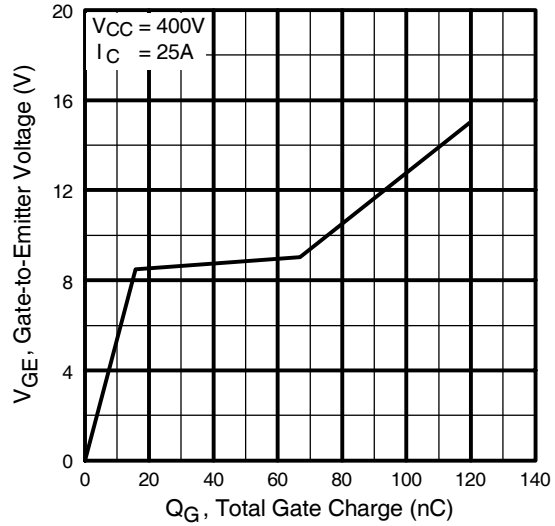
**Fig. 5** - Typical Collector-to-Emitter Voltage vs. Junction Temperature



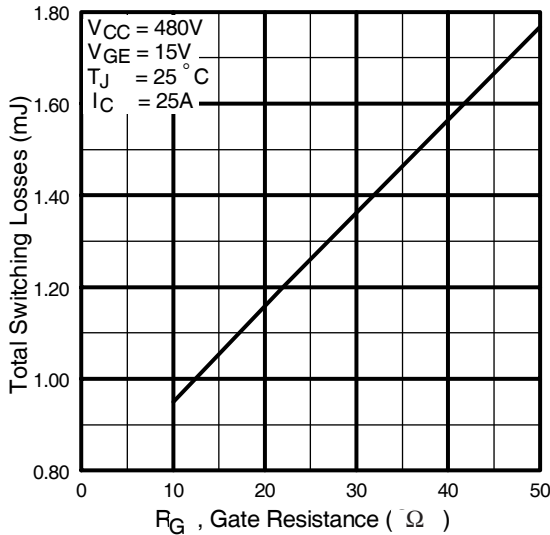
**Fig. 6** - Maximum Effective Transient Thermal Impedance, Junction-to-Case



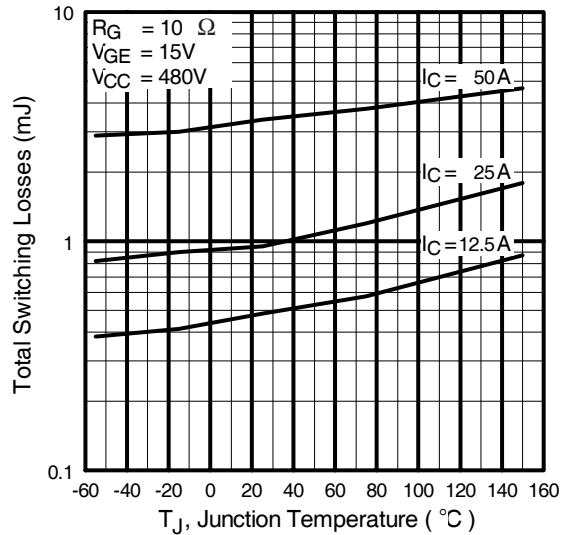
**Fig. 7** - Typical Capacitance vs. Collector-to-Emitter Voltage



**Fig. 8** - Typical Gate Charge vs. Gate-to-Emitter Voltage

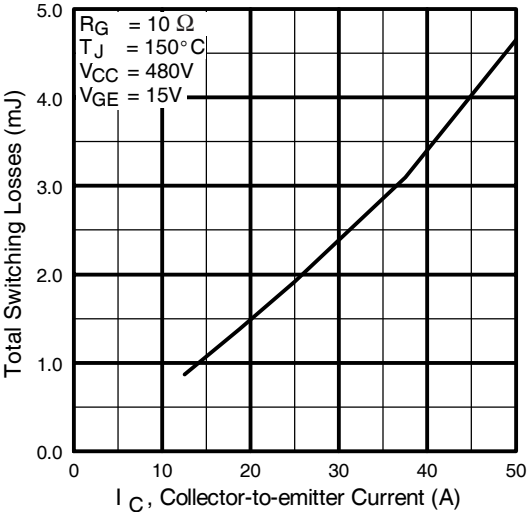


**Fig. 9** - Typical Switching Losses vs. Gate Resistance

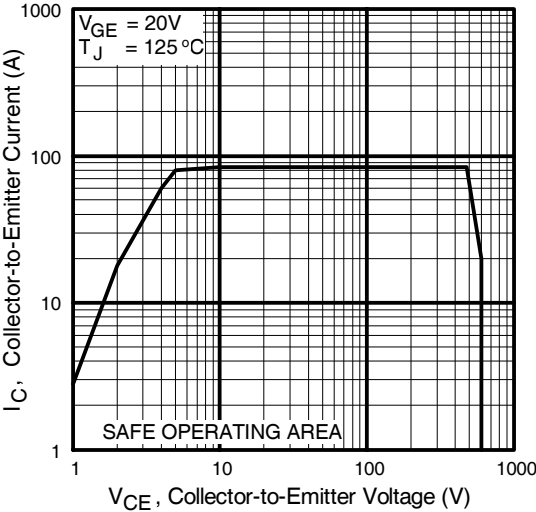


**Fig. 10** - Typical Switching Losses vs. Junction Temperature

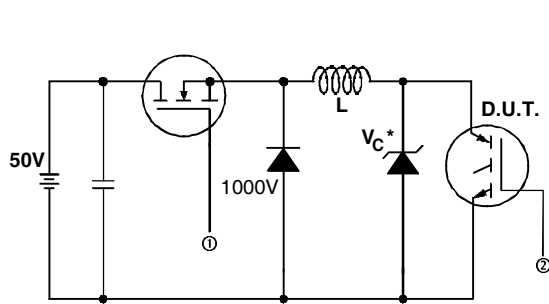
# IRG4BC40KPbF



**Fig. 11** - Typical Switching Losses vs. Collector-to-Emitter Current

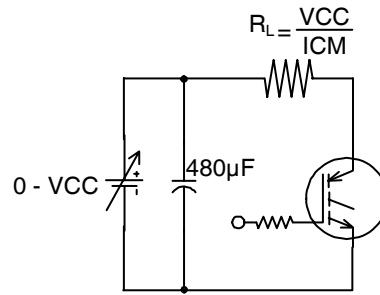


**Fig. 12** - Turn-Off SOA

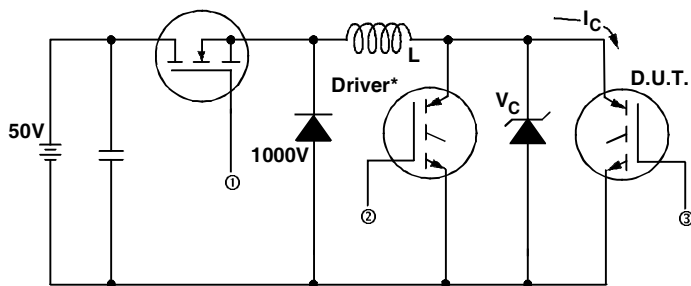


\* Driver same type as D.U.T.;  $V_c = 80\%$  of  $V_{ce(max)}$   
 \* Note: Due to the 50V power supply, pulse width and inductor will increase to obtain rated  $I_d$ .

**Fig. 13a** - Clamped Inductive Load Test Circuit

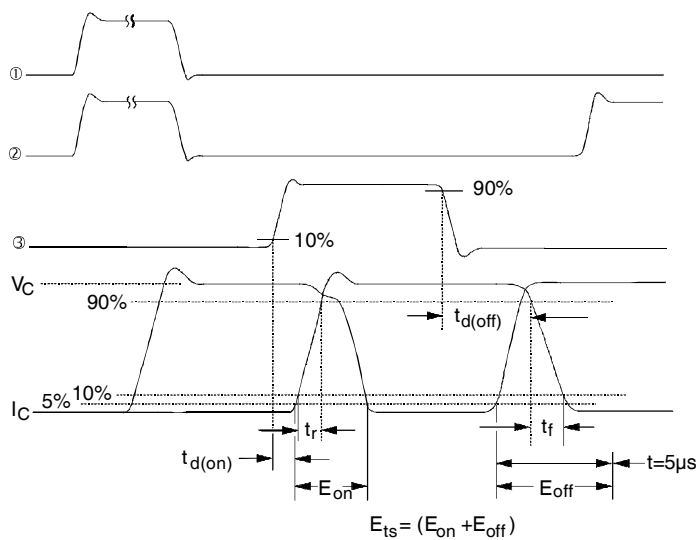


**Fig. 13b** - Pulsed Collector Current Test Circuit



**Fig. 14a** - Switching Loss Test Circuit

\* Driver same type as D.U.T.,  $V_C = 480V$

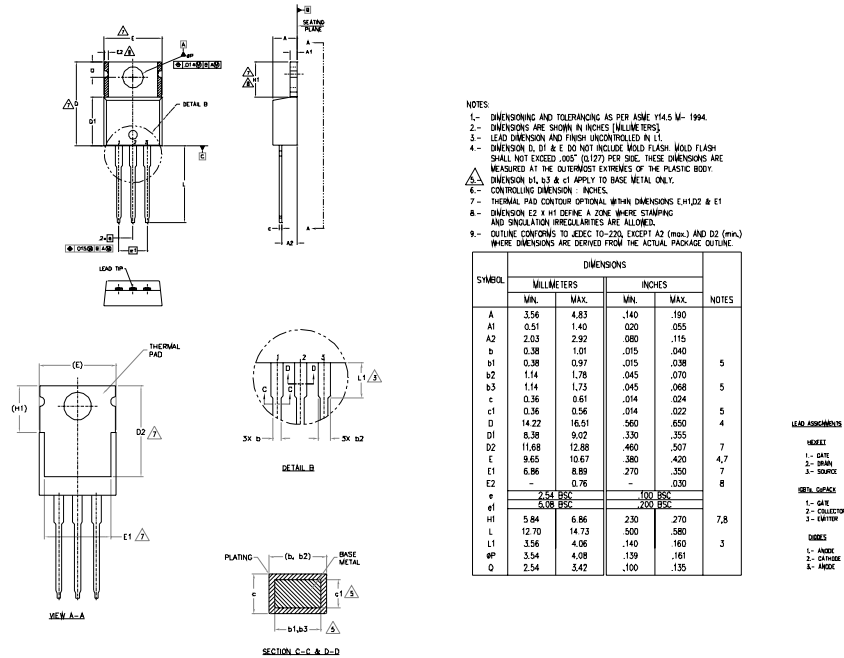


**Fig. 14b** - Switching Loss Waveforms

# IRG4BC40KPbF

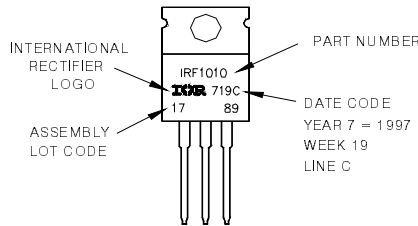
International  
**IR** Rectifier

## TO-220AB Package Outline (Dimensions are shown in millimeters (inches))



## TO-220AB Part Marking Information

EXAMPLE: THIS IS AN IRF1010  
 LOT CODE 1789  
 ASSEMBLED ON WW 19, 1997  
 IN THE ASSEMBLY LINE 'C'  
**Note:** "P" in assembly line position indicates "Lead-Free"



**Note:** For the most current drawing please refer to IR website at <http://www.irf.com/package/>

Data and specifications subject to change without notice.

International  
**IR** Rectifier

**IR WORLD HEADQUARTERS:** 233 Kansas St., El Segundo, California 90245, USA Tel: (310) 252-7105  
 TAC Fax: (310) 252-7903  
 Visit us at [www.irf.com](http://www.irf.com) for sales contact information. 02/2010