

Star Magnetics™ Gigabit Transformer Modules with PoE* Option

* Power over Ethernet

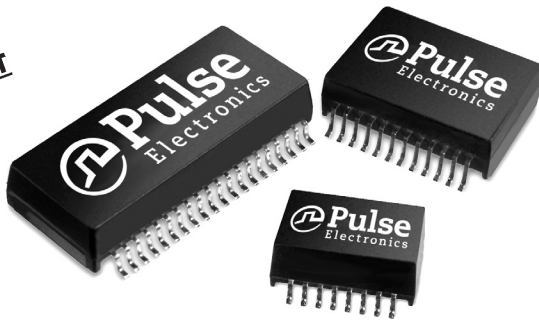

- RoHS reflow temperature rating 245°C
- Meets IEEE 802.3 specification
- Compact footprint

Electrical Specifications @ 25°C - Operating Temperature -40°C to +125°C

RoHS Compliant Part Number	PoE	Turns Ratio		Number of Ports	Insertion Loss (dB MAX)			Return Loss (Zout = 100 Ω ± 15%)				Crosstalk (adjacent channels dB MIN)			Hipot (Vrms MIN)
		Tx	Rx		0.1 MHz	100 MHz	125 MHz	30 MHz	60 MHz	80 MHz	100 MHz	30 MHz	60 MHz	100 MHz	
H5062NL ^{2a,3}	No	1:1	1:1	1	-1.1	-1.0	-2.0	-18	-12	-12	-10	-43	-37	-33	1500
H6062NL ^{2a,3}	Yes	1:1	1:1	1	-1.1	-1.0	-2.0	-18	-12	-12	-10	-43	-37	-33	1500
H6080NL ^{2a,3}	Yes	1:1	1:1	1	-1.1	-1.0	-2.0	-18	-12	-12	-10	-43	-37	-33	1500

Notes:

1. For Tape & Reel packaging, add a "T" suffix to the end of the part number when ordering, e.g. H5062NLT
2. MSL = Moisture Sensitivity Level a = 1 b = 2 c = 3 d = 4 e = 5
3. Not for sale in U.S.

Mechanicals

H5062NL

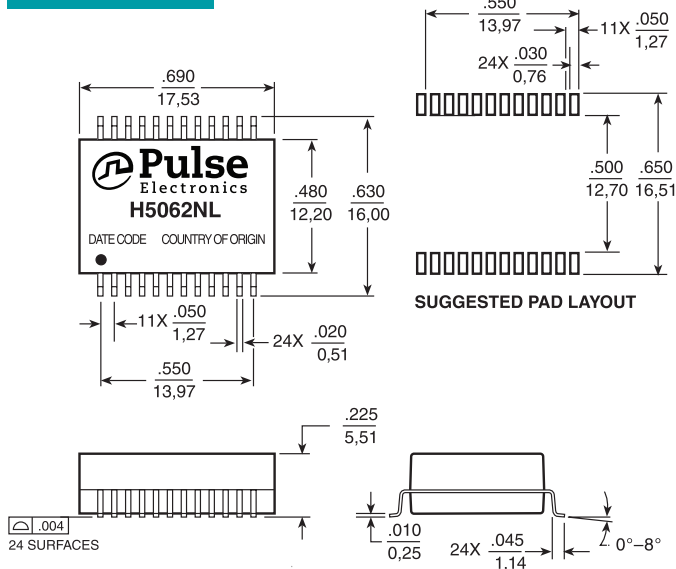

H6062NL

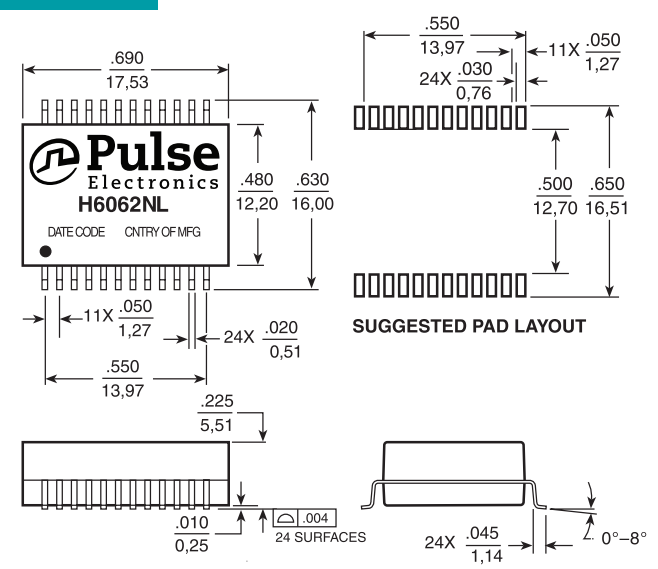

Weight2.7 grams
Tape & Reel300/reel
Tube25/tube

Dimensions: $\frac{\text{Inches}}{\text{mm}}$ Unless otherwise specified, all tolerances are $\pm \frac{.010}{0,25}$

Weight2.63 grams
Tape & Reel300/reel
Tube25/tube

USA 858 674 8100

Germany 49 7032 7806 0

Singapore 65 6287 8998

Shanghai 86 21 62787060

China 86 755 33966678

Taiwan 886 3 4356768

Star Magnetics™ Gigabit Transformer Modules with PoE* Option

* Power over Ethernet



Mechanicals (continued)

H6080NL

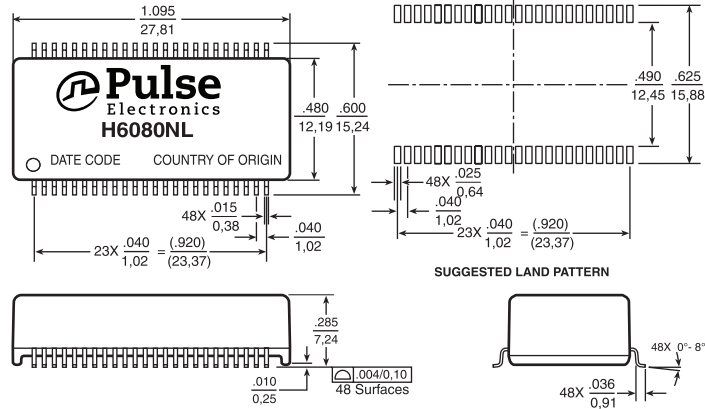

Weight4.0 grams
Tape & Reel250/reel
Tube15/tube

Dimensions: $\frac{\text{Inches}}{\text{mm}}$ Unless otherwise specified, all tolerances are $\pm \frac{.010}{0,25}$

Schematics

H5062NL

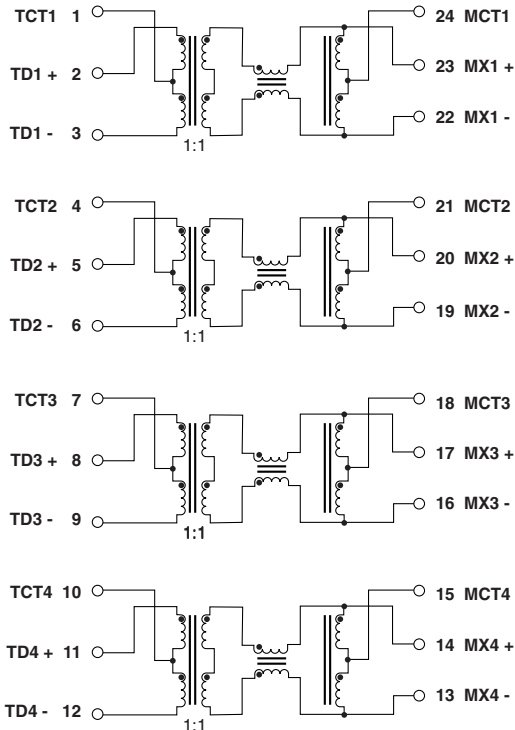

LEGEND

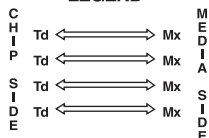

H6062NL

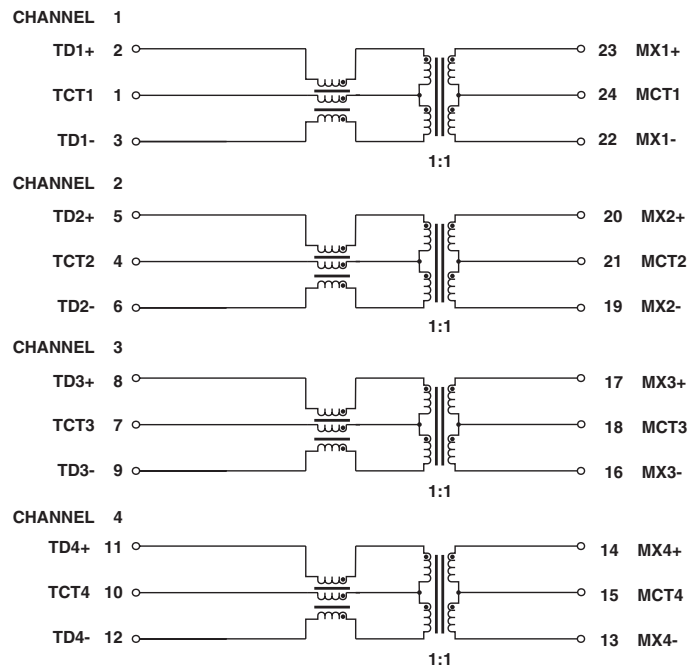

Star Magnetics™ Gigabit Transformer Modules with PoE* Option

* Power over Ethernet

Schematics (continued)

H6080NL

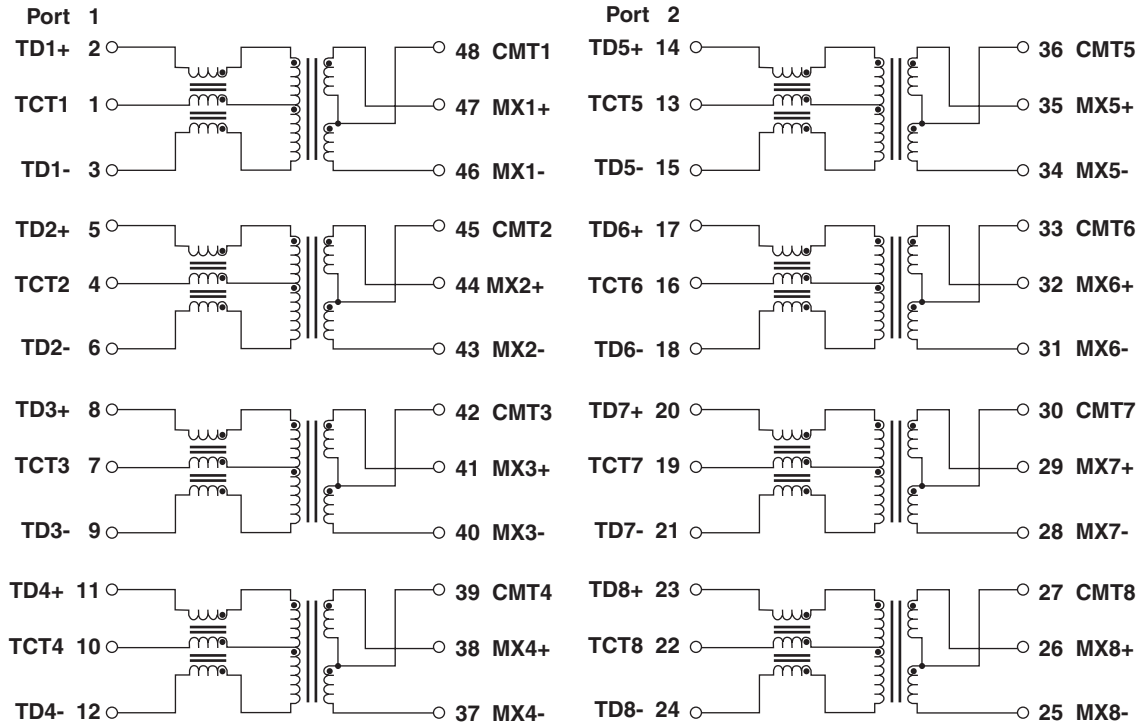

For More Information

Pulse Worldwide Headquarters
12220 World Trade Drive
San Diego, CA
92128
U.S.A.

Tel: 858 674 8100
Fax: 858 674 8262

Pulse Europe
Einsteinstrasse 1
D-71083 Herrenberg
Germany

Tel: 49 7032 78060
Fax: 49 7032 7806 135

Pulse China Headquarters
B402, Shenzhen Academy of
Aerospace Technol-
ogy Bldg.
10th Kejian Road
High-Tech Zone
Nanshan District
Shenzhen, PR China
518057
Tel: 86 755 3396678
Fax: 86 755 33966700

Pulse North China
Room 2704/2705
Super Ocean Finance
Ctr.
2067 Yan An Road
West
Shanghai 200336
China
Tel: 86 21 62787060
Fax: 86 2162786973

Pulse South Asia
135 Joo Seng Road
#03-02
PM Industrial Bldg.
Singapore 368363
Tel: 65 6287 8998
Fax: 65 6287 8998

Pulse North Asia
3F, No. 198
Zhongyuan Road
Zhongli City
Taoyuan County 320
Taiwan R. O. C.
Tel: 886 3 4356768
Fax: 886 3 4356823 (Pulse)
Fax: 886 3 4356820 (FRE)

Performance warranty of products offered on this data sheet is limited to the parameters specified. Data is subject to change without notice. Other brand and product names mentioned herein may be trademarks or registered trademarks of their respective owners. © Copyright, 2013. Pulse Electronics, Inc. All rights reserved.