

Bridgelux® Gen 7 V18 Array Series

Product Data Sheet DS102



Introduction

V Series

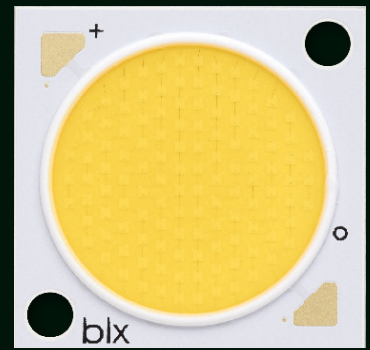

The V Series™ LED Array products deliver high quality light in a compact and cost-effective solid-state lighting package. These chip on board (CoB) arrays can be efficiently driven at twice the nominal drive current, enabling design flexibility not previously possible. This high flux density light source is designed to support a wide range of high quality, low cost directional luminaires and replacement lamps for commercial and residential applications.

The V18 LED Array is available in a variety of electrical, CCT and CRI combinations providing substantial design flexibility and energy efficiencies.

Lighting system designs incorporating these LED arrays deliver increased system level efficacy and longer service life. Typical applications include, replacement lamps, and task, accent, spot, track, wide area, security, wall pack and down lights.

Bridgelux Décor Series is our state of the art color line designed specifically for premium applications, producing unmatched LED light quality with brilliant color-rendering options and offer pleasing and inspiring lighting palettes. Bridgelux Décor Series color points are available on Vero® SE Series, Vero® Series, V Series™ and H Series™.

Décor Series Class A is based on human response testing, providing color points with a combined GAI and CRI metric.

Décor Series™ Ultra products provide a high CRI of 97 and a minimum R9 value of 93, which emphasizes the reds and color tones to which the human eye is most receptive - perfect for the most luxurious retail shops and world renowned museums. Décor Series Ultra is designed as a replacement for halogen lamps.

Décor Series™ Food products offer color points developed to address the unique requirements of the food, grocery, and restaurant industries. Highlighting the distinctive colors and nuanced patterns found in meats and breads, the Décor Series Food products are a must have for any butcher counter or bakery.

Décor Series™ Street and Landmark is designed to be a direct replacement for high pressure sodium lamps.

Décor Series™ Showcase is the optimal solution for replacing ceramic metal halide lamps, incorporating the same pure white light with enhanced spectrum coverage and higher efficacy.

Features

- Efficacy of 160 lm/W typical
- Compact high flux density light source
- Uniform high quality illumination
- Minimum 65, 70, 80, 90 and 95 CRI options
- Streamlined thermal path
- ENERGY STAR® / ANSI compliant color binning structure with 2, 3 and 4 SDCM options
- More energy efficient than incandescent, halogen and fluorescent lamps
- Low voltage DC operation
- Instant light with unlimited dimming
- V_r bin code backside marking

Benefits

- Enhanced optical control
- Clean white light without pixilation
- High quality true color reproduction
- Significantly reduced thermal resistance and increased operating temperatures
- Uniform consistent white light
- Lower operating costs
- Easy to use with daylight and motion detectors to enable increased energy savings
- Reduced maintenance costs
- Environmentally friendly, no disposal issue



Contents

Product Feature Map	2
Product Nomenclature	2
Product Selection Guide	3
Performance at Commonly Used Drive Currents	7
Electrical Characteristics	13
Eye Safety	14
Absolute Maximum Ratings	15
Performance Curves	16
Typical Radiation Pattern	19
Typical Color Spectrum	20
Mechanical Dimensions	21
Color Binning Information	22
Packaging and Labeling	23
Design Resources	25
Precautions	25
Disclaimers	25
About Bridgelux	26

Product Feature Map

Bridgelux arrays are fully engineered devices that provide consistent thermal and optical performance on an engineered mechanical platform. The V Series arrays are the most compact chip-on-board devices across all of

Bridgelux's LED Array products. The arrays incorporate several features to simplify design integration and assembly. Please visit www.bridgelux.com for more information on the V Series family of products.

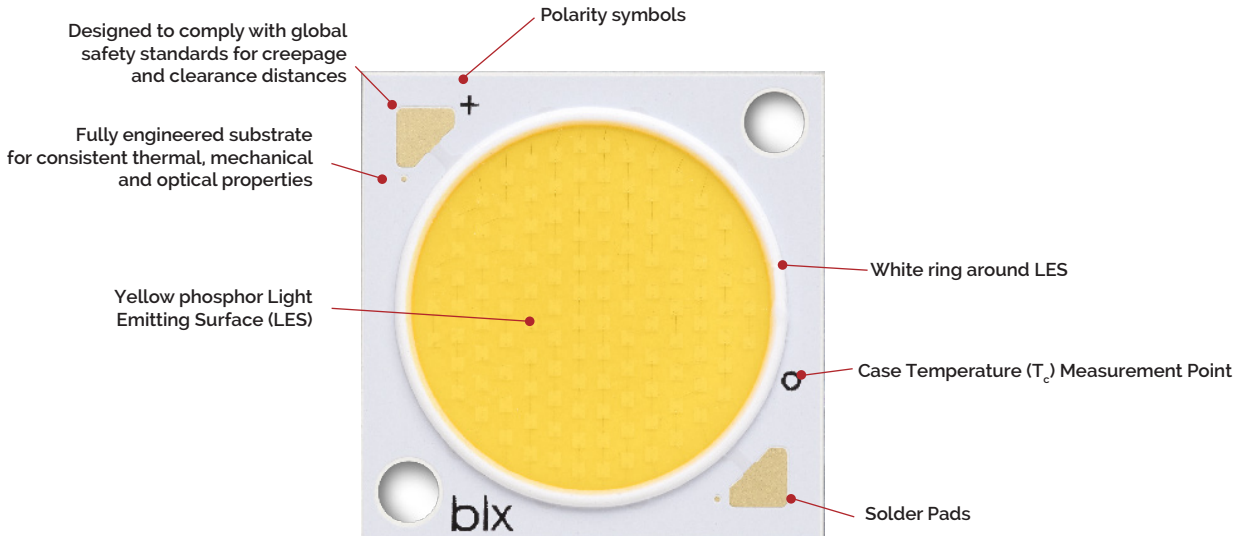

Note: Part number and lot codes are scribed on back of array

Product Nomenclature

The part number designation for Bridgelux V Series LED arrays is explained as follows:

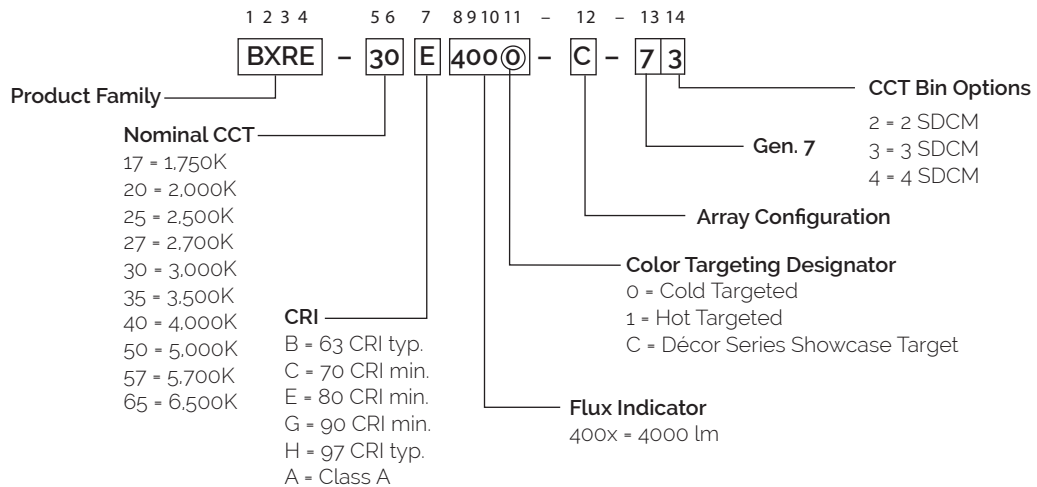

Product Selection Guide

The following product configurations are available:

Table 1: Selection Guide, Pulsed Measurement Data ($T_j = T_c = 25^\circ\text{C}$)

Part Number	Nominal CCT ¹ (K)	CRI ²	Nominal Drive Current ³ (mA)	Typical Pulsed Flux ^{4,5,6} $T_c = 25^\circ\text{C}$ (lm)	Minimum Pulsed Flux ^{6,7} $T_c = 25^\circ\text{C}$ (lm)	Typical V_f (V)	Typical Power (W)	Typical Efficacy (lm/W)
BXRE-17E4000-B-74	1750	80	900	2774	2497	34.8	31.3	89
BXRE-20B4001-C-73	2000	65	1170	6081	5473	34.8	40.7	149
BXRE-25E4000-B-74	2500	80	900	4484	4036	34.8	31.3	143
BXRE-27E4000-B-7X	2700	80	900	4807	4326	34.8	31.3	153
BXRE-27E4000-C-7X	2700	80	1170	6249	5624	34.8	40.7	153
BXRE-27G40H0-B-7X	2700	90	900	4166	3749	34.8	31.3	133
BXRE-27G40H0-C-7X	2700	90	1170	5415	4874	34.8	40.7	133
BXRE-27G4000-B-7X	2700	90	900	4000	3600	34.8	31.3	128
BXRE-27G4000-C-7X	2700	90	900	5200	4680	34.8	40.7	128
BXRE-27H4000-B-7X	2700	97	1170	3484	3136	34.8	31.3	111
BXRE-30C4001-B-74	3000	70	900	5512	4961	34.8	31.3	176
BXRE-30C4001-C-74	3000	70	1170	7166	6449	34.8	40.7	176
BXRE-30E4000-B-7X	3000	80	1170	5000	4500	34.8	31.3	160
BXRE-30E4000-C-7X	3000	80	900	6500	5850	34.8	40.7	160
BXRE-30G40H0-B-7X	3000	90	900	4353	3918	34.8	31.3	139
BXRE-30G40H0-C-7X	3000	90	1170	5660	5094	34.8	40.7	139
BXRE-30G4000-B-7X	3000	90	900	4161	3745	34.8	31.3	133
BXRE-30G4000-C-7X	3000	90	1170	5410	4869	34.8	40.7	133
BXRE-30G400C-B-73	3000	90	900	3881	3493	34.8	31.4	124
BXRE-30H4000-B-7X	3000	97	900	3710	3339	34.8	31.3	118
BXRE-35E4000-B-7X	3500	80	1170	5162	4645	34.8	31.3	165
BXRE-35E4000-C-7X	3500	80	900	6710	6039	34.8	40.7	165
BXRE-35G4000-B-7X	3500	90	1170	4291	3861	34.8	31.3	137
BXRE-35G4000-C-7X	3500	90	900	5578	5020	34.8	40.7	137
BXRE-35A4001-B-73 ^{8,9}	3500	93	1170	4040	3636	34.8	31.3	129
BXRE-40C4001-B-74	4000	70	900	5645	5081	34.8	31.3	180
BXRE-40C4001-C-74	4000	70	1170	7339	6605	34.8	40.7	180
BXRE-40E4000-B-7X	4000	80	900	5194	4674	34.8	31.3	166
BXRE-40E4000-C-7X	4000	80	1170	6752	6077	34.8	40.7	166
BXRE-40G4000-B-7X	4000	90	900	4452	4007	34.8	31.3	142
BXRE-40G4000-C-7X	4000	90	1170	5787	5209	34.8	40.7	142
BXRE-50C4001-B-74	5000	70	900	5710	5139	34.8	31.3	182
BXRE-50C4001-C-74	5000	70	1170	7423	6681	34.8	40.7	182

Notes for Table 1:

- Nominal CCT as defined by ANSI C78.377-2011. Products with a CCT of 5000K-6500K are hot targeted to $T_c = 85^\circ\text{C}$.
- CRI values are typical for Decor Series Ultra, Décor Series Street and Landmark and Decor Series Class A products. CRI values are minimums for all other products. Minimum R_g value for 80 CRI products is 0, the minimum R_g values for 90 CRI products is 50, the minimum R_g values for 97 CRI products is 93. Bridgelux maintains a ± 3 tolerance on R_g values.
- Drive current is referred to as nominal drive current.
- Products tested under pulsed condition (10ms pulse width) at nominal test current where T_j (junction temperature) = T_c (case temperature) = 25°C .
- Typical performance values are provided as a reference only and are not a guarantee of performance.
- Bridgelux maintains a $\pm 7\%$ tolerance on flux measurements.
- Minimum flux values at the nominal test current are guaranteed by 100% test.
- Nominal CCT is defined by the Lighting Research Center's Class A definition. The center of the Class A color bin is on the corresponding isothermal line.
- GAI value is 80. To help ensure optimal fixture level performance, GAI is measured at the fixture level, on axis, at a case temperature of 70°C . GAI may vary depending on fixture design and performance.

Product Selection Guide

The following product configurations are available:

Table 1: Selection Guide, Pulsed Measurement Data ($T_j = T_c = 25^\circ\text{C}$) (continued)

Part Number	Nominal CCT ¹ (K)	CRI ²	Nominal Drive Current ³ (mA)	Typical Pulsed Flux ^{4,5,6} $T_c = 25^\circ\text{C}$ (lm)	Minimum Pulsed Flux ^{6,7} $T_c = 25^\circ\text{C}$ (lm)	Typical V_f (V)	Typical Power (W)	Typical Efficacy (lm/W)
BXRE-50E4001-B-74	5000	80	900	5355	4820	34.8	31.3	171
BXRE-50E4001-C-74	5000	80	1170	6962	6265	34.8	40.7	171
BXRE-50G4001-B-74	5000	90	900	4549	4094	34.8	31.3	145
BXRE-50G4001-C-74	5000	90	1170	5913	5322	34.8	40.7	145
BXRE-57C4001-B-74	5700	70	900	5516	4965	34.8	31.3	176
BXRE-57C4001-C-74	5700	70	1170	7171	6454	34.8	40.7	176
BXRE-57E4001-B-74	5700	80	900	5293	4764	34.8	31.3	169
BXRE-57E4001-C-74	5700	80	1170	6881	6193	34.8	40.7	169
BXRE-65C4001-B-74	6500	70	900	5613	5052	34.8	31.3	179
BXRE-65C4001-C-74	6500	70	1170	7297	6567	34.8	40.7	179
BXRE-65E4001-B-74	6500	80	900	5387	4848	34.8	31.3	172
BXRE-65E4001-C-74	6500	80	1170	7003	6303	34.8	40.7	172

Notes for Table 1:

- Nominal CCT as defined by ANSI C78.377-2011. Products with a CCT of 5000K-6500K are hot targeted to $T_c = 85^\circ\text{C}$.
- CRI values are typical for Decor Series Ultra, Décor Series Street and Landmark and Decor Series Class A products. CRI values are minimums for all other products. Minimum R_g value for 80 CRI products is 0, the minimum R_g values for 90 CRI products is 50, the minimum R_g values for 97 CRI products is 93. Bridgelux maintains a ± 3 tolerance on R_g values.
- Drive current is referred to as nominal drive current.
- Products tested under pulsed condition (10ms pulse width) at nominal test current where T_j (junction temperature) - T_c (case temperature) = 25°C .
- Typical performance values are provided as a reference only and are not a guarantee of performance.
- Bridgelux maintains a $\pm 7\%$ tolerance on flux measurements.
- Minimum flux values at the nominal test current are guaranteed by 100% test.
- Nominal CCT is defined by the Lighting Research Center's Class A definition. The center of the Class A color bin is on the corresponding isothermal line.
- GAI value is 80. To help ensure optimal fixture level performance, GAI is measured at the fixture level, on axis, at a case temperature of 70°C . GAI may vary depending on fixture design and performance.

Table 2: Selection Guide, Stabilized DC Performance ($T_c = 70^\circ\text{C}$)^{7,8}

Part Number	Nominal CCT ¹ (K)	GAI ²	CRI ³	Nominal Drive Current ⁴ (mA)	Typical DC Flux ^{5,6} $T_c = 70^\circ\text{C}$ (lm)	Minimum DC Flux ^{6,9} $T_c = 70^\circ\text{C}$ (lm)	Typical V_f (V)	Typical Power (W)	Typical Efficacy (lm/W)
BXRE-35A4001-B-73	3500	80	93	900	3757	3382	34.3	30.9	121

Notes for Table 2:

- Nominal CCT is defined by the Lighting Research Center's Class A definition. The center of the Class A color bin is on the corresponding isothermal line.
- To help ensure optimal fixture level performance, GAI is measured at the fixture level, on axis, at a case temperature of 70°C . GAI may vary depending on fixture design and performance.
- All CRI values are measured at $T_j = T_c = 25^\circ\text{C}$. CRI Values are specified as typical.
- Drive current is referred to as nominal drive current.
- Typical performance values are provided as a reference only and are not a guarantee of performance.
- Bridgelux maintains a $\pm 7\%$ tolerance on flux measurements.
- Typical stabilized DC performance values are provided as reference only and are not a guarantee of performance.
- Typical performance is estimated based on operation under DC (direct current) with LED array mounted onto a heat sink with thermal interface material and the case temperature maintained at specified temperature. Based on Bridgelux test setup, values may vary depending on the thermal design of the luminaire and/or the exposed environment to which the product is subjected.
- Minimum flux values at elevated temperatures are provided for reference only and are not guaranteed by 100% production testing. Based on Bridgelux test setup, values may vary depending on the thermal design of the luminaire and/or the exposed environment to which the product is subjected.

Product Selection Guide

Table 3: Selection Guide, Stabilized DC Performance ($T_c = 85^\circ\text{C}$)^{4,5}

Part Number	Nominal CCT ¹ (K)	CRI ²	Nominal Drive Current ³ (mA)	Typical DC Flux ^{4,5} $T_c = 85^\circ\text{C}$ (lm)	Minimum DC Flux ⁶ $T_c = 85^\circ\text{C}$ (lm)	Typical V_f (V)	Typical Power (W)	Typical Efficacy (lm/W)
BXRE-17E4000-B-74	1750	80	900	2497	2497	2247	30.6	82
BXRE-20B4001-C-73	2000	65	1170	5473	5473	4926	39.8	138
BXRE-25E4000-B-74	2500	80	900	4036	4036	3632	30.6	132
BXRE-27E4000-B-7X	2700	80	900	4326	4326	3893	30.6	142
BXRE-27E4000-C-7X	2700	80	1170	5624	5624	5061	39.7	142
BXRE-27G40H0-B-7X	2700	90	900	3600	3749	3374	30.6	123
BXRE-27G40H0-C-7X	2700	90	1170	4680	4874	4386	39.7	123
BXRE-27G4000-B-7X	2700	90	900	3136	3600	3240	30.6	118
BXRE-27G4000-C-7X	2700	90	1170	4500	4680	4212	39.7	118
BXRE-27H4000-B-7X	2700	97	900	5850	3136	2822	30.6	103
BXRE-30C4001-B-74	3000	70	900	3745	4961	4465	30.6	162
BXRE-30C4001-C-74	3000	70	1170	4869	6449	5804	39.7	162
BXRE-30E4000-B-7X	3000	80	900	3493	4500	4050	30.6	147
BXRE-30E4000-C-7X	3000	80	1170	3339	5850	5265	39.7	147
BXRE-30G40H0-B-7X	3000	90	900	4645	3918	3526	30.6	128
BXRE-30G40H0-C-7X	3000	90	1170	6039	5094	4584	39.7	128
BXRE-30G4000-B-7X	3000	90	900	3861	3745	3371	30.6	123
BXRE-30G4000-C-7X	3000	90	1170	5020	4869	4382	39.7	123
BXRE-30G400C-B-73	3000	90	900	3636	3493	3144	30.6	114
BXRE-30H4000-B-7X	3000	97	900	4674	3339	3005	30.6	109
BXRE-35E4000-B-7X	3500	80	900	6077	4645	4181	30.6	152
BXRE-35E4000-C-7X	3500	80	1170	4007	6039	5435	39.7	152
BXRE-35G4000-B-7X	3500	90	900	5209	3861	3475	30.6	126
BXRE-35G4000-C-7X	3500	90	1170	5139	5020	4518	39.7	126
BXRE-35A4001-B-73 ^{8,9}	3500	93	900	6681	3636	3273	30.6	119
BXRE-40C4001-B-74	4000	70	900	4820	5081	4573	30.6	166
BXRE-40C4001-C-74	4000	70	1170	6265	6605	5945	39.7	166
BXRE-40E4000-B-7X	4000	80	900	4094	4674	4207	30.6	153
BXRE-40E4000-C-7X	4000	80	1170	5322	6077	5469	39.7	153
BXRE-40G4000-B-7X	4000	90	900	4965	4007	3606	30.6	131
BXRE-40G4000-C-7X	4000	90	1170	6454	5209	4688	39.7	131
BXRE-50C4001-B-74	5000	70	900	4764	5139	4625	30.6	168
BXRE-50C4001-C-74	5000	70	1170	6193	6681	6013	39.7	168

Notes for Table 3:

- Nominal CCT as defined by ANSI C78.377-2011. Products with a CCT of 5000K-6500K are hot targeted to $T_c = 85^\circ\text{C}$.
- All CRI values are measured at $T_c = 25^\circ\text{C}$. CRI values are typical for Decor Series Ultra, Decor Series Street and Landmark and Decor Series Class A products. CRI values are minimums for all other products. Minimum Rg value for 80 CRI products is 0, the minimum Rg values for 90 CRI products is 50, the minimum Rg values for 97 CRI products is 93. Bridgelux maintains a ± 3 tolerance on Rg values.
- Drive current is referred to as nominal drive current.
- Typical stabilized DC performance values are provided as reference only and are not a guarantee of performance.
- Typical performance is estimated based on operation under DC (direct current) with LED array mounted onto a heat sink with thermal interface material and the case temperature maintained at 85°C . Based on Bridgelux test setup, values may vary depending on the thermal design of the luminaire and/or the exposed environment to which the product is subjected.
- Minimum flux values at elevated temperatures are provided for reference only and are not guaranteed by 100% production testing. Based on Bridgelux test setup, values may vary depending on the thermal design of the luminaire and/or the exposed environment to which the product is subjected.
- Nominal CCT is defined by the Lighting Research Center's Class A definition. The center of the Class A color bin is on the corresponding isothermal line.
- GAI value is 80. To help ensure optimal fixture level performance, GAI is measured at the fixture level, on axis, at a case temperature of 70°C . GAI may vary depending on fixture design and performance.

Product Selection Guide

Table 3: Selection Guide, Stabilized DC Performance ($T_c = 85^\circ\text{C}$)⁴⁵ (continued)

Part Number	Nominal CCT ¹ (K)	CRI ²	Nominal Drive Current ³ (mA)	Typical DC Flux ^{4,5} $T_c = 85^\circ\text{C}$ (lm)	Minimum DC Flux ⁶ $T_c = 85^\circ\text{C}$ (lm)	Typical V_f (V)	Typical Power (W)	Typical Efficacy (lm/W)
BXRE-50E4001-B-74	5000	80	900	4820	4338	33.9	30.6	158
BXRE-50E4001-C-74	5000	80	1170	6265	5639	33.9	39.7	158
BXRE-50G4001-B-74	5000	90	900	4094	3684	33.9	30.6	134
BXRE-50G4001-C-74	5000	90	1170	5322	4790	33.9	39.7	134
BXRE-57C4001-B-74	5700	70	900	4965	4468	33.9	30.6	162
BXRE-57C4001-C-74	5700	70	1170	6454	5809	33.9	39.7	162
BXRE-57E4001-B-74	5700	80	900	4764	4287	33.9	30.6	156
BXRE-57E4001-C-74	5700	80	1170	6193	5574	33.9	39.7	156
BXRE-65C4001-B-74	6500	70	900	5052	4547	33.9	30.6	165
BXRE-65C4001-C-74	6500	70	1170	6567	5911	33.9	39.7	165
BXRE-65E4001-B-74	6500	80	900	4848	4364	33.9	30.6	159
BXRE-65E4001-C-74	6500	80	1170	6303	5673	33.9	39.7	159

Notes for Table 3:

- Nominal CCT as defined by ANSI C78.377-2011. Products with a CCT of 5000K-6500K are hot targeted to $T_c = 85^\circ\text{C}$.
- All CRI values are measured at $T_s = T_c = 25^\circ\text{C}$. CRI values are typical for Decor Series Ultra, Décor Series Street and Landmark and Decor Series Class A products. CRI values are minimums for all other products. Minimum Rg value for 80 CRI products is 0, the minimum Rg values for 90 CRI products is 50, the minimum Rg values for 97 CRI products is 93. 4. Bridgelux maintains a ± 3 tolerance on Rg values.
- Drive current is referred to as nominal drive current.
- Typical stabilized DC performance values are provided as reference only and are not a guarantee of performance.
- Typical performance is estimated based on operation under DC (direct current) with LED array mounted onto a heat sink with thermal interface material and the case temperature maintained at 85°C . Based on Bridgelux test setup, values may vary depending on the thermal design of the luminaire and/or the exposed environment to which the product is subjected.
- Minimum flux values at elevated temperatures are provided for reference only and are not guaranteed by 100% production testing. Based on Bridgelux test setup, values may vary depending on the thermal design of the luminaire and/or the exposed environment to which the product is subjected.
- Nominal CCT is defined by the Lighting Research Center's Class A definition. The center of the Class A color bin is on the corresponding isothermal line.
- GAI value is 80. To help ensure optimal fixture level performance, GAI is measured at the fixture level, on axis, at a case temperature of 70°C . GAI may vary depending on fixture design and performance.

Performance at Commonly Used Drive Currents

V Series LED arrays are tested to the specifications shown using the nominal drive currents in Table 1. V Series may also be driven at other drive currents dependent on specific application design requirements. The performance at any drive current can be derived from the current vs. voltage characteristics shown in Figures 1 & 2 and the flux vs. current characteristics shown in Figures 3 & 4. The performance at commonly used drive currents is summarized in Table 4.

Table 4: Product Performance at Commonly Used Drive Currents

Part Number	CRI	Drive Current ¹ (mA)	Typical V _f T _c = 25°C (V)	Typical Power T _c = 25°C (W)	Typical Flux ² T _c = 25°C (lm)	Typical DC Flux ³ T _c = 85°C (lm)	Typical Efficacy T _c = 25°C (lm/W)
BXRE-17E4000-B-74	80	450	33.2	14.9	1467	1344	98
		600	33.8	20.3	1923	1758	95
		900	34.8	31.4	2774	2497	88
		1350	36.3	49.0	4014	3641	82
		1800	37.5	67.5	5119	4621	76
BXRE-20B4001-C-73	65	585	33.2	19.4	3132	2759	161
		780	33.8	26.3	4102	3595	156
		1170	34.8	40.8	6081	5473	149
		1755	36.2	63.6	8536	7286	134
		2340	37.5	87.6	10864	9112	124
BXRE-25E4000-B-74	80	450	33.2	14.9	2371	2172	159
		600	33.8	20.3	3108	2842	153
		900	34.8	31.4	4484	4036	143
		1350	36.3	49.0	6488	5885	133
		1800	37.5	67.5	8274	7469	123
BXRE-27E4000-B-7X	80	450	33.2	14.9	2542	2329	170
		600	33.8	20.3	3332	3046	164
		900	34.8	31.4	4807	4326	153
		1350	36.3	49.0	6955	6309	142
		1800	37.5	67.5	8869	8006	131
BXRE-27E4000-C-7X	80	585	33.2	19.4	3218	2835	166
		780	33.8	26.3	4215	3694	160
		1170	34.8	40.8	6249	5624	153
		1755	36.2	63.6	8772	7487	138
		2340	37.5	87.6	11164	9363	127
BXRE-27G40H0-B-7X	90	450	33.2	14.9	2203	2018	147
		600	33.8	20.3	2887	2640	142
		900	34.8	31.4	4166	3749	133
		1350	36.3	49.0	6027	5467	123
		1800	37.5	67.5	7686	6939	114
BXRE-27G40H0-C-7X	90	585	33.2	19.4	2789	2457	144
		780	33.8	26.3	3653	3201	139
		1170	34.8	40.8	5415	4874	133
		1755	36.2	63.6	7602	6488	120
		2340	37.5	87.6	9675	8114	110
BXRE-27G4000-B-7X	90	450	33.2	14.9	2116	1938	142
		600	33.8	20.3	2773	2535	137
		900	34.8	31.4	4000	3600	128
		1350	36.3	49.0	5788	5250	118
		1800	37.5	67.5	7381	6663	109

Notes for Table 4:

1. Alternate drive currents are provided for reference only and are not a guarantee of performance.
2. Bridgelux maintains a ± 7% tolerance on flux measurements.
3. Typical stabilized DC performance values are provided as reference only and are not a guarantee of performance.

Performance at Commonly Used Drive Currents

Table 4: Product Performance at Commonly Used Drive Currents (Continued)

Part Number	CRI	Drive Current ¹ (mA)	Typical V _f T _c = 25°C (V)	Typical Power T _c = 25°C (W)	Typical Flux ² T _c = 25°C (lm)	Typical DC Flux ³ T _c = 85°C (lm)	Typical Efficacy T _c = 25°C (lm/W)
BXRE-27G4000-C-7X	90	585	33.2	19.4	2678	2360	138
		780	33.8	26.3	3508	3074	133
		1170	34.8	40.8	5200	4680	128
		1755	36.2	63.6	7300	6230	115
		2340	37.5	87.6	9291	7792	106
BXRE-27H4000-B-7X	97	450	33.2	14.9	1843	1688	123
		600	33.8	20.3	2415	2208	119
		900	34.8	31.4	3484	3136	111
		1350	36.3	49.0	5041	4573	103
		1800	37.5	67.5	6428	5803	95
BXRE-30C4001-B-74	70	450	33.2	14.9	2839	2501	190
		600	33.8	20.3	3719	3258	184
		900	34.8	31.4	5512	4961	176
		1350	36.3	49.0	7738	6604	158
		1800	37.5	67.5	9848	8260	146
BXRE-30C4001-C-74	70	585	33.2	19.4	3790	3472	195
		780	33.8	26.3	4967	4541	189
		1170	34.8	40.8	7166	6449	176
		1755	36.2	63.6	10368	9405	163
		2340	37.5	87.6	13222	11936	151
BXRE-30E4000-B-7X	80	450	33.2	14.9	2644	2422	177
		600	33.8	20.3	3466	3169	171
		900	34.8	31.4	5000	4500	159
		1350	36.3	49.0	7235	6563	148
		1800	37.5	67.5	9226	8329	137
BXRE-30E4000-C-7X	80	585	33.2	19.4	3348	2949	172
		780	33.8	26.3	4385	3842	166
		1170	34.8	40.8	6500	5850	159
		1755	36.2	63.6	9125	7788	143
		2340	37.5	87.6	11613	9740	133
BXRE-30G40H0-B-7X	90	450	33.2	14.9	2302	2109	154
		600	33.8	20.3	3017	2759	149
		900	34.8	31.4	4353	3918	139
		1350	36.3	49.0	6299	5714	129
		1800	37.5	67.5	8033	7252	119
BXRE-30G40H0-C-7X	90	585	33.2	19.4	2915	2568	150
		780	33.8	26.3	3818	3345	145
		1170	34.8	40.8	5660	5094	139
		1755	36.2	63.6	7945	6781	125
		2340	37.5	87.6	10111	8480	115
BXRE-30G4000-B-7X	90	450	33.2	14.9	2201	2016	147
		600	33.8	20.3	2884	2637	142
		900	34.8	31.4	4161	3745	133
		1350	36.3	49.0	6021	5462	123
		1800	37.5	67.5	7678	6932	114

Notes for Table 4:

1. Alternate drive currents are provided for reference only and are not a guarantee of performance.
2. Bridgelux maintains a ± 7% tolerance on flux measurements.
3. Typical stabilized DC performance values are provided as reference only and are not a guarantee of performance.

Performance at Commonly Used Drive Currents

Table 4: Product Performance at Commonly Used Drive Currents (Continued)

Part Number	CRI	Drive Current ¹ (mA)	Typical V _f T _c = 25°C (V)	Typical Power T _c = 25°C (W)	Typical Flux ² T _c = 25°C (lm)	Typical DC Flux ³ T _c = 85°C (lm)	Typical Efficacy T _c = 25°C (lm/W)
BXRE-30G4000-C-7X	90	585	33.2	19.4	2786	2455	143
		780	33.8	26.3	3650	3198	139
		1170	34.8	40.8	5410	4869	133
		1755	36.2	63.6	7594	6482	119
		2340	37.5	87.6	9665	8106	110
BXRE-30G400C-B-73	90	450	33.2	14.9	2052	1880	137
		600	33.8	20.3	2690	2459	133
		900	34.8	31.4	3881	3493	124
		1350	36.3	49.0	5615	5094	115
		1800	37.5	67.5	7161	6465	106
BXRE-30H4000-B-7X	97	450	33.2	14.9	1962	1797	131
		600	33.8	20.3	2571	2351	127
		900	34.8	31.4	3710	3339	118
		1350	36.3	49.0	5368	4869	110
		1800	37.5	67.5	6845	6180	101
BXRE-35E4000-B-7X	80	450	33.2	14.9	2730	2501	183
		600	33.8	20.3	3577	3271	177
		900	34.8	31.4	5162	4645	165
		1350	36.3	49.0	7468	6774	153
		1800	37.5	67.5	9524	8598	141
BXRE-35E4000-C-7X	80	585	33.2	19.4	3456	3045	178
		780	33.8	26.3	4527	3966	172
		1170	34.8	40.8	6710	6039	165
		1755	36.2	63.6	9419	8039	148
		2340	37.5	87.6	11988	10054	137
BXRE-35G4000-B-7X	90	450	33.2	14.9	2269	2079	152
		600	33.8	20.3	2974	2719	147
		900	34.8	31.4	4291	3861	137
		1350	36.3	49.0	6208	5631	127
		1800	37.5	67.5	7916	7147	117
BXRE-35G4000-C-7X	90	585	33.2	19.4	2873	2531	148
		780	33.8	26.3	3763	3297	143
		1170	34.8	40.8	5578	5020	137
		1755	36.2	63.6	7830	6683	123
		2340	37.5	87.6	9965	8358	114
BXRE-35A4001-B-73	93	450	33.2	14.9	2137	1957	143
		600	33.8	20.3	2800	2560	138
		900	34.8	31.4	4040	3636	129
		1350	36.3	49.0	5846	5303	119
		1800	37.5	67.5	7455	6730	110
BXRE-40C4001-B-74	70	450	33.2	14.9	2908	2562	195
		600	33.8	20.3	3808	3337	188
		900	34.8	31.4	5645	5081	180
		1350	36.3	49.0	7925	6764	162
		1800	37.5	67.5	10086	8459	149

Notes for Table 4:

1. Alternate drive currents are provided for reference only and are not a guarantee of performance.
2. Bridgelux maintains a ± 7% tolerance on flux measurements.
3. Typical stabilized DC performance values are provided as reference only and are not a guarantee of performance.

Performance at Commonly Used Drive Currents

Table 4: Product Performance at Commonly Used Drive Currents (Continued)

Part Number	CRI	Drive Current ¹ (mA)	Typical V _f T _c = 25°C (V)	Typical Power T _c = 25°C (W)	Typical Flux ² T _c = 25°C (lm)	Typical DC Flux ³ T _c = 85°C (lm)	Typical Efficacy T _c = 25°C (lm/W)
BXRE-40C4001-C-74	70	585	33.2	19.4	3881	3555	200
		780	33.8	26.3	5087	4651	193
		1170	34.8	40.8	7339	6605	180
		1755	36.2	63.6	10619	9632	167
		2340	37.5	87.6	13541	12225	155
BXRE-40E4000-B-7X	80	450	33.2	14.9	2747	2516	184
		600	33.8	20.3	3600	3291	178
		900	34.8	31.4	5194	4674	166
		1350	36.3	49.0	7515	6817	153
		1800	37.5	67.5	9583	8651	142
BXRE-40E4000-C-7X	80	585	33.2	19.4	3478	3064	179
		780	33.8	26.3	4555	3991	173
		1170	34.8	40.8	6752	6077	166
		1755	36.2	63.6	9478	8089	149
		2340	37.5	87.6	12063	10117	138
BXRE-40G4000-B-7X	90	450	33.2	14.9	2354	2157	158
		600	33.8	20.3	3086	2821	152
		900	34.8	31.4	4452	4007	142
		1350	36.3	49.0	6441	5843	132
		1800	37.5	67.5	8214	7415	122
BXRE-40G4000-C-7X	90	585	33.2	19.4	2981	2626	153
		780	33.8	26.3	3904	3421	148
		1170	34.8	40.8	5787	5209	142
		1755	36.2	63.6	8124	6934	128
		2340	37.5	87.6	10340	8672	118
BXRE-50C4001-B-74	70	450	33.2	14.9	3020	2766	202
		600	33.8	20.3	3958	3618	195
		900	34.8	31.4	5710	5139	182
		1350	36.3	49.0	8261	7494	169
		1800	37.5	67.5	10535	9511	156
BXRE-50C4001-C-74	70	585	33.2	19.4	3823	3368	197
		780	33.8	26.3	5007	4388	190
		1170	34.8	40.8	7423	6681	182
		1755	36.2	63.6	10420	8893	164
		2340	37.5	87.6	13262	11123	151
BXRE-50E4001-B-74	80	450	33.2	14.9	2832	2594	190
		600	33.8	20.3	3712	3394	183
		900	34.8	31.4	5355	4820	171
		1350	36.3	49.0	7748	7028	158
		1800	37.5	67.5	9881	8920	146
BXRE-50E4001-C-74	80	585	33.2	19.4	3586	3159	185
		780	33.8	26.3	4696	4115	178
		1170	34.8	40.8	6962	6265	171
		1755	36.2	63.6	9773	8341	154
		2340	37.5	87.6	12437	10431	142

Notes for Table 4:

1. Alternate drive currents are provided for reference only and are not a guarantee of performance.
2. Bridgelux maintains a ± 7% tolerance on flux measurements.
3. Typical stabilized DC performance values are provided as reference only and are not a guarantee of performance.

Performance at Commonly Used Drive Currents

Table 4: Product Performance at Commonly Used Drive Currents (Continued)

Part Number	CRI	Drive Current ¹ (mA)	Typical V _f T _c = 25°C (V)	Typical Power T _c = 25°C (W)	Typical Flux ² T _c = 25°C (lm)	Typical DC Flux ³ T _c = 85°C (lm)	Typical Efficacy T _c = 25°C (lm/W)
BXRE-50G4001-B-74	90	450	33.2	14.9	2406	2204	161
		600	33.8	20.3	3153	2882	156
		900	34.8	31.4	4549	4094	145
		1350	36.3	49.0	6581	5970	134
		1800	37.5	67.5	8393	7577	124
BXRE-50G4001-C-74	90	585	33.2	19.4	3046	2683	157
		780	33.8	26.3	3989	3495	151
		1170	34.8	40.8	5913	5322	145
		1755	36.2	63.6	8301	7085	131
		2340	37.5	87.6	10564	8860	121
BXRE-57C4001-B-74	70	450	33.2	14.9	2917	2672	195
		600	33.8	20.3	3823	3496	189
		900	34.8	31.4	5516	4965	176
		1350	36.3	49.0	7981	7240	163
		1800	37.5	67.5	10178	9189	151
BXRE-57C4001-C-74	70	585	33.2	19.4	3694	3254	190
		780	33.8	26.3	4838	4239	184
		1170	34.8	40.8	7171	6454	176
		1755	36.2	63.6	10067	8592	158
		2340	37.5	87.6	12812	10746	146
BXRE-57E4001-B-74	80	450	33.2	14.9	2799	2564	187
		600	33.8	20.3	3669	3354	181
		900	34.8	31.4	5293	4764	169
		1350	36.3	49.0	7658	6947	156
		1800	37.5	67.5	9766	8817	145
BXRE-57E4001-C-74	80	585	33.2	19.4	3544	3122	182
		780	33.8	26.3	4642	4067	176
		1170	34.8	40.8	6881	6193	169
		1755	36.2	63.6	9660	8244	152
		2340	37.5	87.6	12293	10311	140
BXRE-65C4001-B-74	70	450	33.2	14.9	2969	2719	199
		600	33.8	20.3	3890	3557	192
		900	34.8	31.4	5613	5052	179
		1350	36.3	49.0	8121	7367	166
		1800	37.5	67.5	10357	9350	153
BXRE-65C4001-C-74	70	585	33.2	19.4	3759	3311	194
		780	33.8	26.3	4923	4313	187
		1170	34.8	40.8	7297	6567	179
		1755	36.2	63.6	10244	8743	161
		2340	37.5	87.6	13037	10934	149
BXRE-65E4001-B-74	80	450	33.2	14.9	2849	2610	191
		600	33.8	20.3	3734	3414	184
		900	34.8	31.4	5387	4848	172
		1350	36.3	49.0	7794	7070	159
		1800	37.5	67.5	9940	8973	147

Notes for Table 4:

1. Alternate drive currents are provided for reference only and are not a guarantee of performance.
2. Bridgelux maintains a ± 7% tolerance on flux measurements.
3. Typical stabilized DC performance values are provided as reference only and are not a guarantee of performance.

Performance at Commonly Used Drive Currents

Table 4: Product Performance at Commonly Used Drive Currents (Continued)

Part Number	CRI	Drive Current ¹ (mA)	Typical V_f $T_c = 25^\circ\text{C}$ (V)	Typical Power $T_c = 25^\circ\text{C}$ (W)	Typical Flux ² $T_c = 25^\circ\text{C}$ (lm)	Typical DC Flux ³ $T_c = 85^\circ\text{C}$ (lm)	Typical Efficacy $T_c = 25^\circ\text{C}$ (lm/W)
BXRE-65E4001-C-74	80	585	33.2	19.4	3607	3178	186
		780	33.8	26.3	4724	4140	179
		1170	34.8	40.8	7003	6303	172
		1755	36.2	63.6	9831	8390	155
		2340	37.5	87.6	12512	10494	143

Notes for Table 4:

1. Alternate drive currents are provided for reference only and are not a guarantee of performance.
2. Bridgelux maintains a $\pm 7\%$ tolerance on flux measurements.
3. Typical stabilized DC performance values are provided as reference only and are not a guarantee of performance.

Electrical Characteristics

Table 5: Electrical Characteristics

Part Number	Drive Current (mA)	Forward Voltage Pulsed, $T_c = 25^\circ\text{C}$ (V) ^{1, 2, 3, 8}			Typical Coefficient of Forward Voltage ⁴ $\Delta V_f / \Delta T_c$ (mV/ $^\circ\text{C}$)	Typical Thermal Resistance Junction to Case ^{5,6} R_{j-c} ($^\circ\text{C}/\text{W}$)	Driver Selection Voltages ⁷ (V)	
		Minimum	Typical	Maximum			V_f Min. Hot $T_c = 105^\circ\text{C}$ (V)	V_f Max. Cold $T_c = -40^\circ\text{C}$ (V)
BXRE-xxx400x-B-7x	900	32.2	34.8	37.5	-14.5	0.15	31.1	38.4
	1800	34.7	37.5	40.3	-14.5	0.18	33.5	41.2
BXRE-xxx400x-C-7x	1170	32.2	34.8	37.5	-14.5	0.11	31.1	38.4
	2340	34.6	37.5	40.3	-14.5	0.13	33.5	41.2

Notes for Table 5:

- Parts are tested in pulsed conditions. $T_c = 25^\circ\text{C}$. Pulse width is 10ms.
- Voltage minimum and maximum are provided for reference only and are not a guarantee of performance.
- Bridgelux maintains a tester tolerance of $\pm 0.10\text{V}$ on forward voltage measurements.
- Typical coefficient of forward voltage tolerance is $\pm 0.1\text{mV}$ for nominal current.
- Thermal resistance values are based from test data of a 3000K 80 CRI product.
- Thermal resistance value was calculated using total electrical input power; optical power was not subtracted from input power. The thermal interface material used during testing is not included in the thermal resistance value.
- V_f min hot and max cold values are provided as reference only and are not guaranteed by test. These values are provided to aid in driver design and selection over the operating range of the product.
- This product has been designed and manufactured per IEC 62031:2014. This product has passed dielectric withstand voltage testing at 1160 V. The working voltage designated for the insulation is 80V d.c. The maximum allowable voltage across the array must be determined in the end product application.

Eye Safety

Table 6: Eye Safety Risk Group (RG) Classifications

Part Number	Drive Current ⁵ (mA)	CCT ¹⁻⁵			
		2700K/3000K	4000K ²	5000K ³	6500K ⁴
BXRE-xxx400x-B-7x	900	RG1	RG1	RG1	RG1
	1350	RG1	RG1	RG1	RG2
	1800	RG1	RG1	RG2	RG2
BXRE-xxx400x-C-7x	1170	RG1	RG1	RG1	RG1
	1755	RG1	RG1	RG2	RG2
	2340	RG1	RG1	RG2	RG2

Notes for Table 6:

1. Eye safety classification for the use of Bridgelux V Series LED arrays is in accordance with specification IEC/TR 62778: Application of IEC 62471 for the assessment of blue light hazard to light sources and luminaires.
2. For products classified as RG2 at 4000K, $E_{thr} = 1847.5$ lx.
3. For products classified as RG2 at 5000K, $E_{thr} = 1315.8$ lx.
4. For products classified as RG2 at 6500K, $E_{thr} = 1124.5$ lx.
5. Please contact your Bridgelux sales representative for E_{thr} values at specific drive currents and CCTs not listed.

Absolute Maximum Ratings

Table 7: Maximum Ratings

Parameter	Maximum Rating	
LED Junction Temperature (T_j)	125°C	
Storage Temperature	-40°C to +105°C	
Operating Case Temperature ¹ (T_c)	105°C	
Soldering Temperature ²	300°C or lower for a maximum of 6 seconds	
	BXRE-xxx400x-B-7x	BXRE-xxx400x-C-7x
Maximum Drive Current ³	1800mA	2340mA
Maximum Peak Pulsed Drive Current ⁴	2570mA	3340mA
Maximum Reverse Voltage ⁵	-60V	-60V

Notes for Table 7:

1. For IEC 62717 requirement, please consult your Bridgelux sales representative.
2. Refer to Bridgelux Application Note AN101: Handling and Assembly of Bridgelux V Series LED Arrays
3. Arrays may be driven at higher currents however lumen maintenance may be reduced.
4. Bridgelux recommends a maximum duty cycle of 10% and pulse width of 20 ms when operating LED Arrays at maximum peak pulsed current specified. Maximum peak pulsed currents indicate values where LED Arrays can be driven without catastrophic failures.
5. Light emitting diodes are not designed to be driven in reverse voltage and will not produce light under this condition. Maximum rating provided for reference only.

Performance Curves

Figure 1: V18B Drive Current vs. Voltage

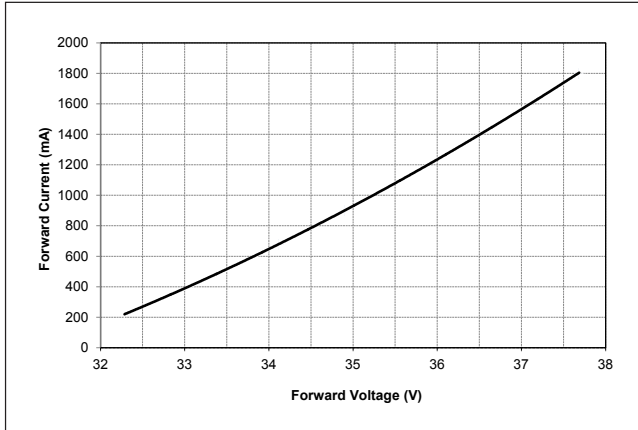

Figure 2: V18C Drive Current vs. Voltage

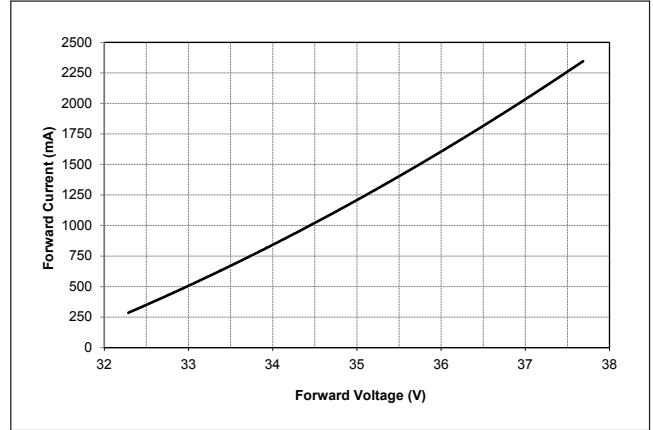

Figure 3: V18B Typical Relative Flux vs. Current

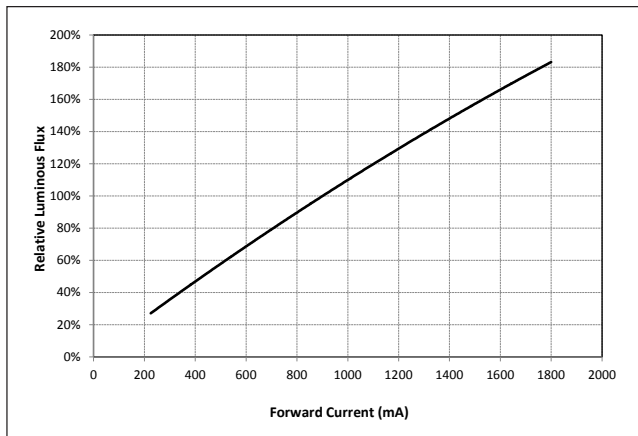
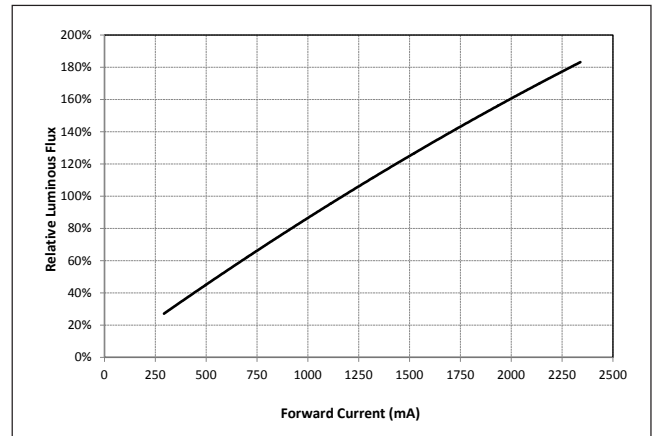

Figure 4: V18C Typical Relative Flux vs. Current



Notes for Figures 1-4:

1. Bridgelux does not recommend driving high power LEDs at low currents. Doing so may produce unpredictable results. Pulse width modulation (PWM) is recommended for dimming effects.
2. Products tested under pulsed condition (10ms pulse width) at nominal test current where T_j (junction temperature) - T_c (case temperature) = 25°C.

Performance Curves

Figure 5: Typical DC Flux vs. Case Temperature

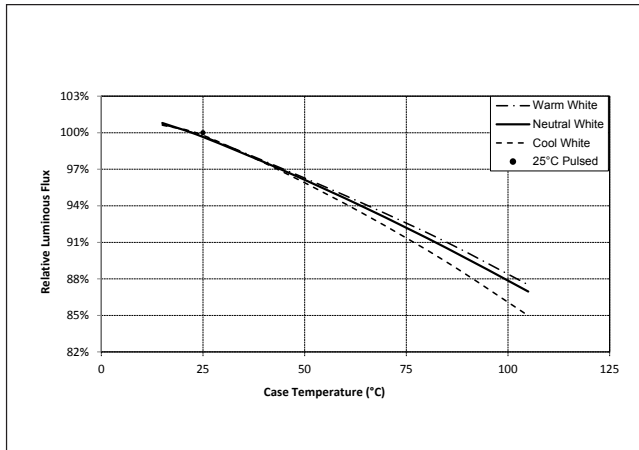

Figure 6: Typical DC ccy Shift vs. Case Temperature

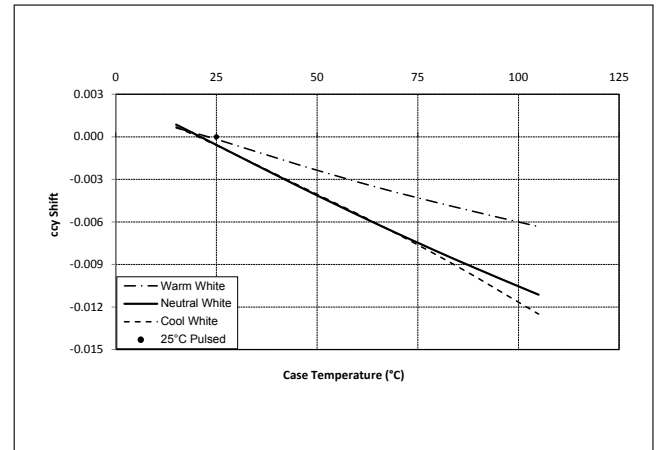

Figure 7: Typical DC ccx Shift vs. Case Temperature

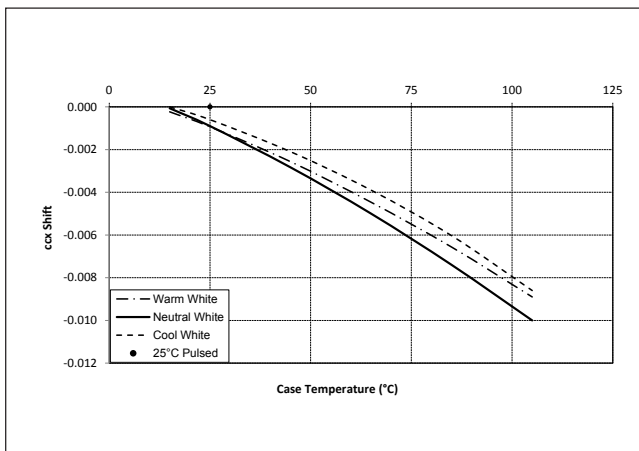
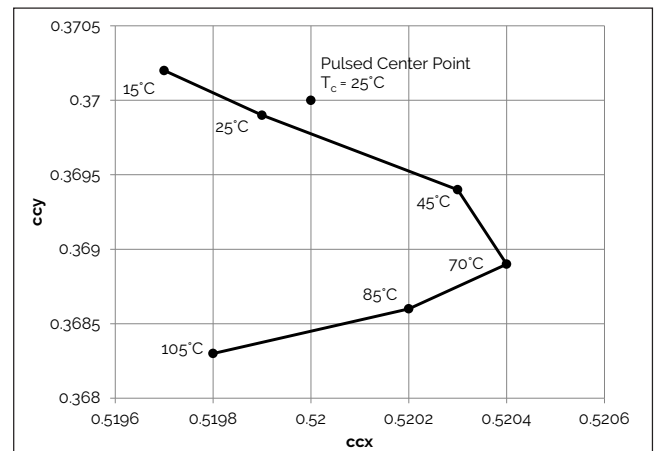

Figure 8: 1750K Color Shift vs. Case Temperature¹



Notes for Figures 5-7:

1. Characteristics shown for warm white based on 3000K and 80 CRI.
2. Characteristics shown for neutral white based on 4000K and 80 CRI.
3. Characteristics shown for cool white based on 5000K and 70 CRI.
4. For other color SKUs, the shift in color will vary. Please contact your Bridgelux Sales Representative for more information.

Performance Curves

Figure 9: 2000K, 65 CRI Color Shift vs. Case Temperature¹

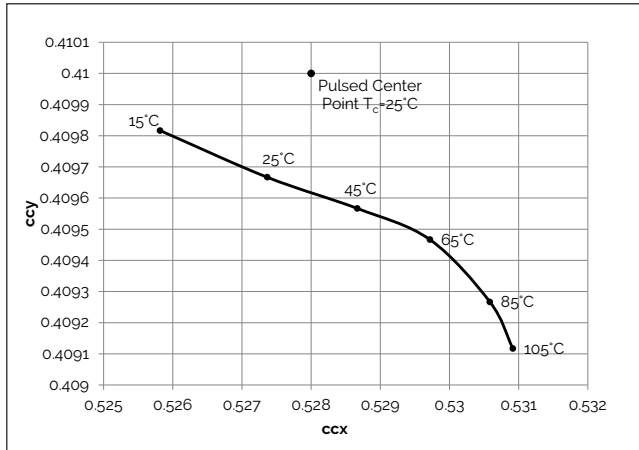

Figure 10: 2500K Color Shift vs. Case Temperature¹

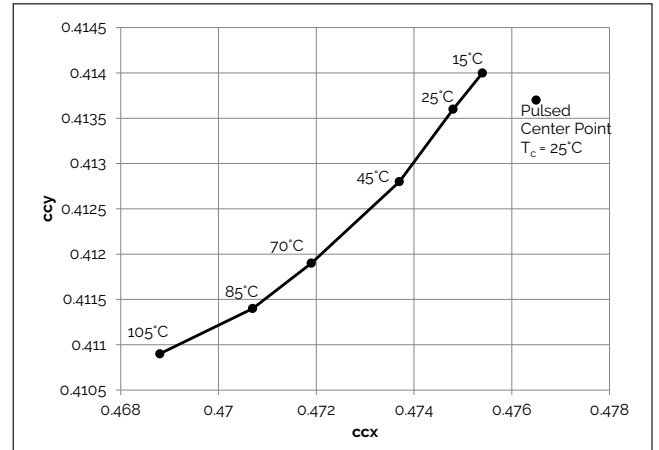

Figure 11: 2700K, 97 CRI Color Shift vs. Case Temperature¹

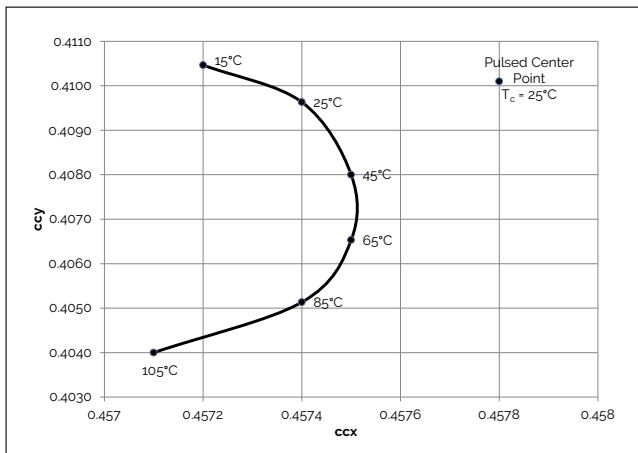

Figure 12: 3000K, 90 CRI Color Shift vs. Case Temperature³

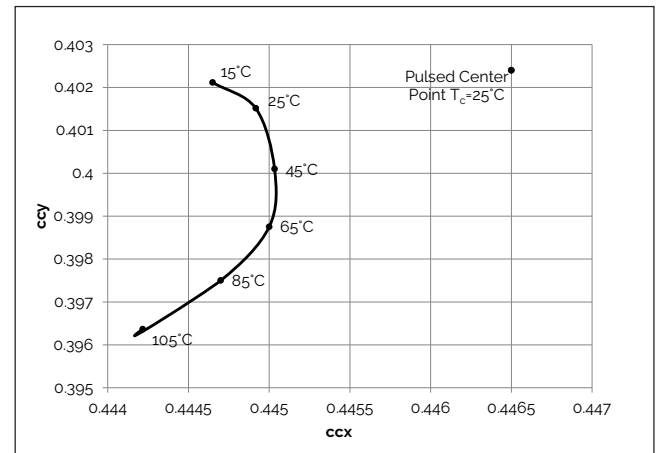

Figure 13: 3000K, 97 CRI Color Shift vs. Case Temperature¹

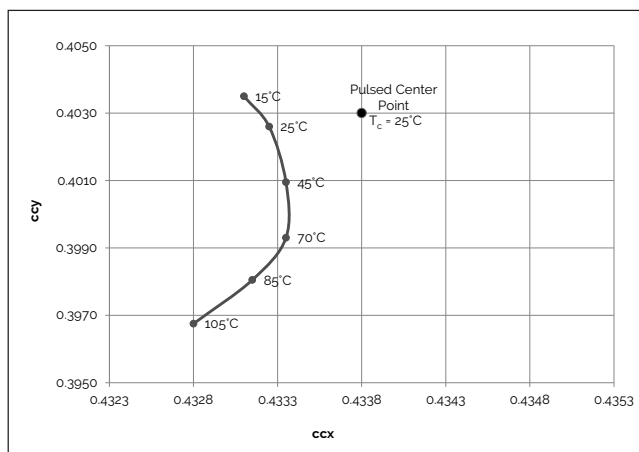
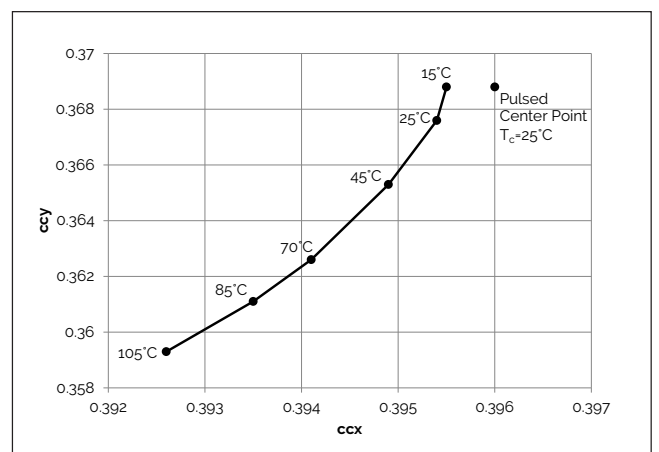

Figure 14: 3500K Class A Color Shift vs. Case Temperature¹



Note for Figures 8-14:

1. Measurements made under DC test conditions at the nominal drive current.
2. Typical color shift is shown with a tolerance of ± 0.002 .
3. Characteristics shown for Decor Series Showcase products. BXRE-30G400C-x-73

Typical Radiation Pattern

Figure 15: Typical Spatial Radiation Pattern

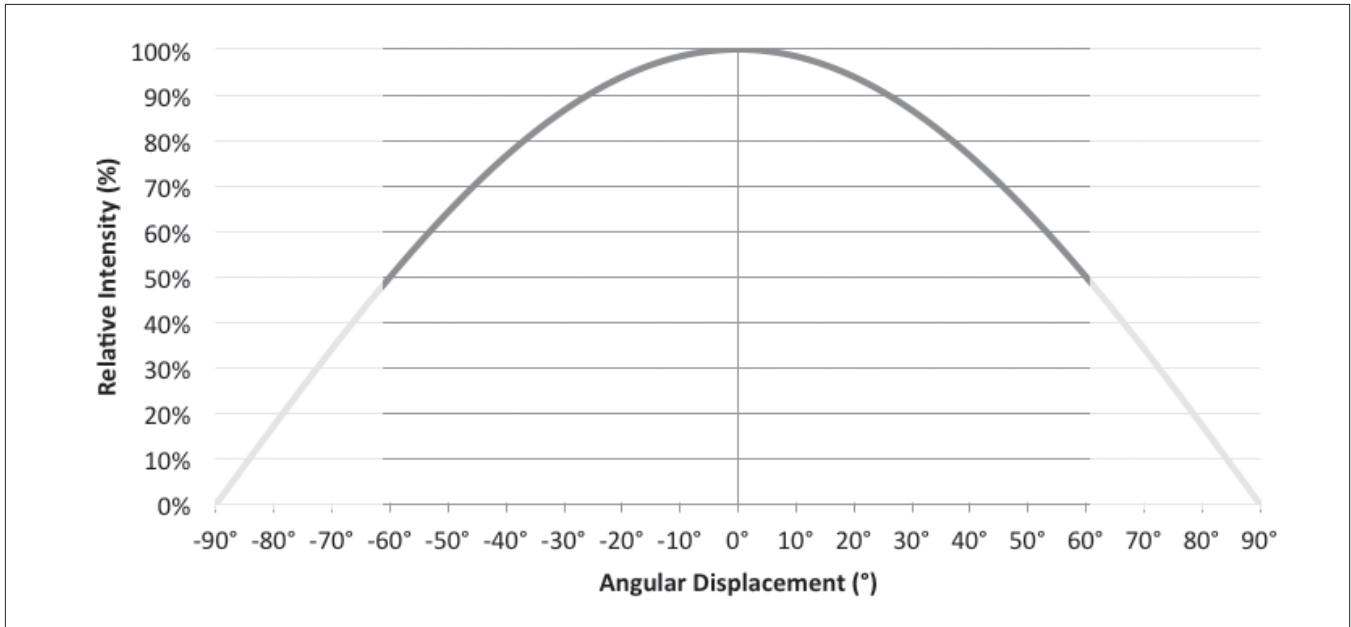

Note for Figure 15:

1. Typical viewing angle is 120°.
2. The viewing angle is defined as the off axis angle from the centerline where intensity is ½ of the peak value.

Figure 16: Typical Polar Radiation Pattern

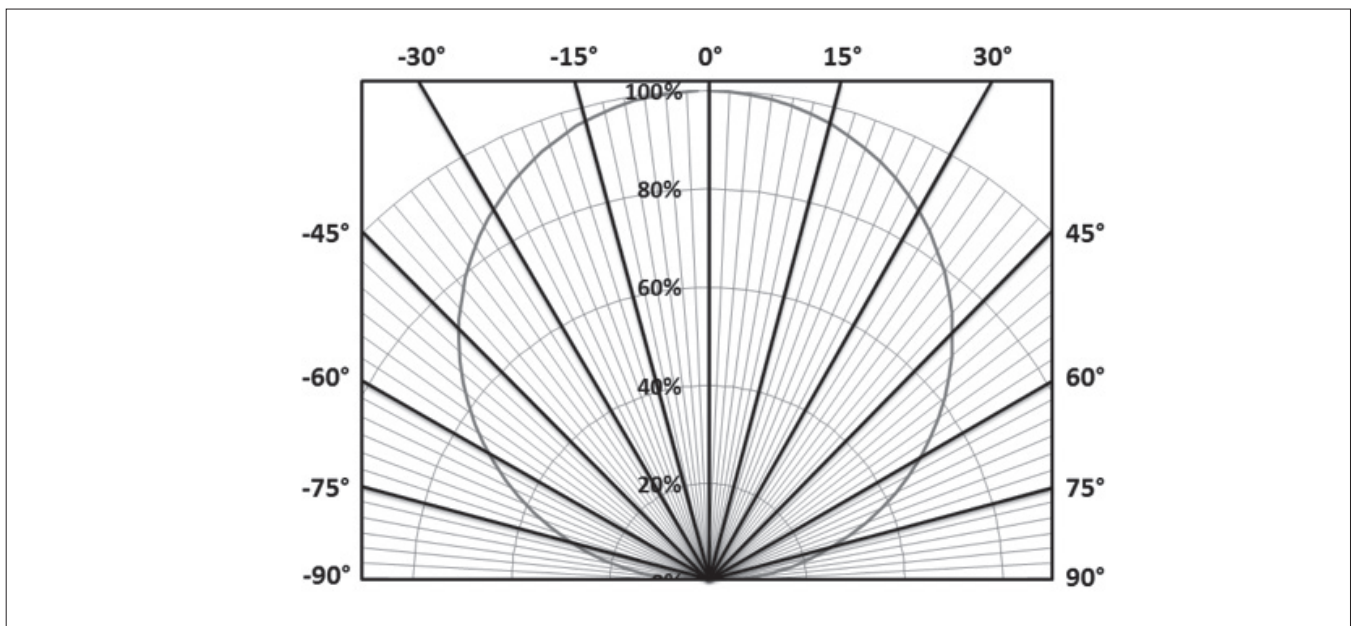

Typical Color Spectrum

Figure 17: Typical Color Spectrum

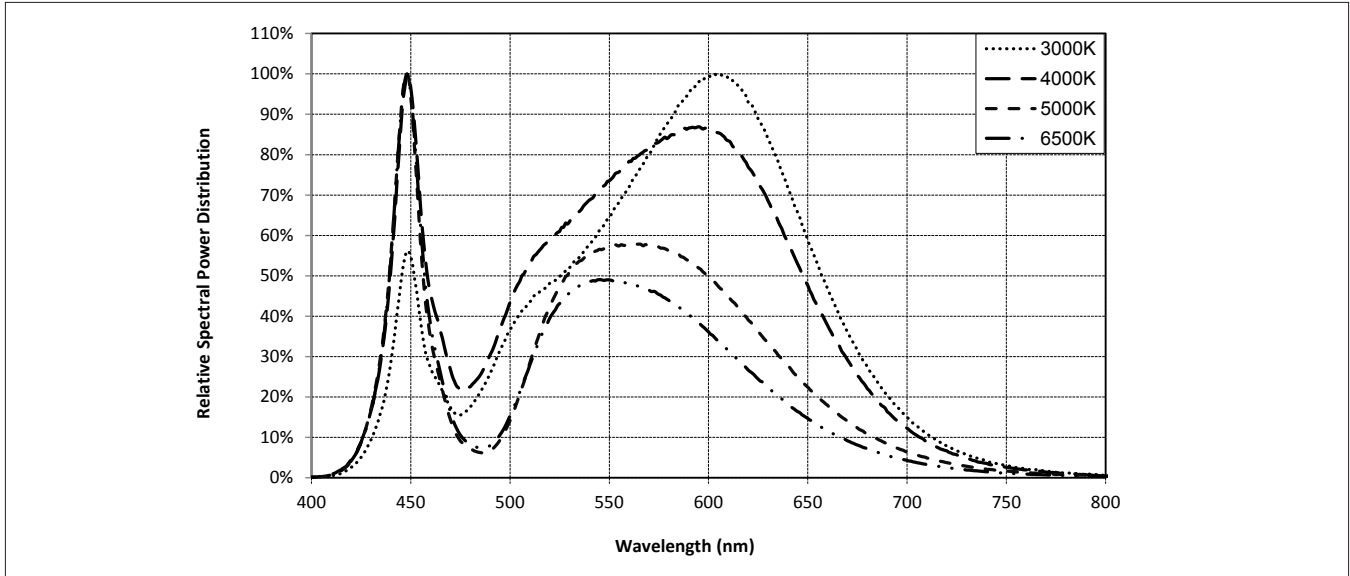

Note for Figure 17:

1. Color spectra measured at nominal current for $T_j = T_c = 25^\circ\text{C}$.
2. Color spectra shown is 3000K and 80 CRI.
3. Color spectra shown is 4000K and 80 CRI.
4. Color spectra shown is 5000K and 70 CRI.
4. Color spectra shown is 6500K and 70 CRI.

Figure 18: Typical Color Spectrum for Décor Series

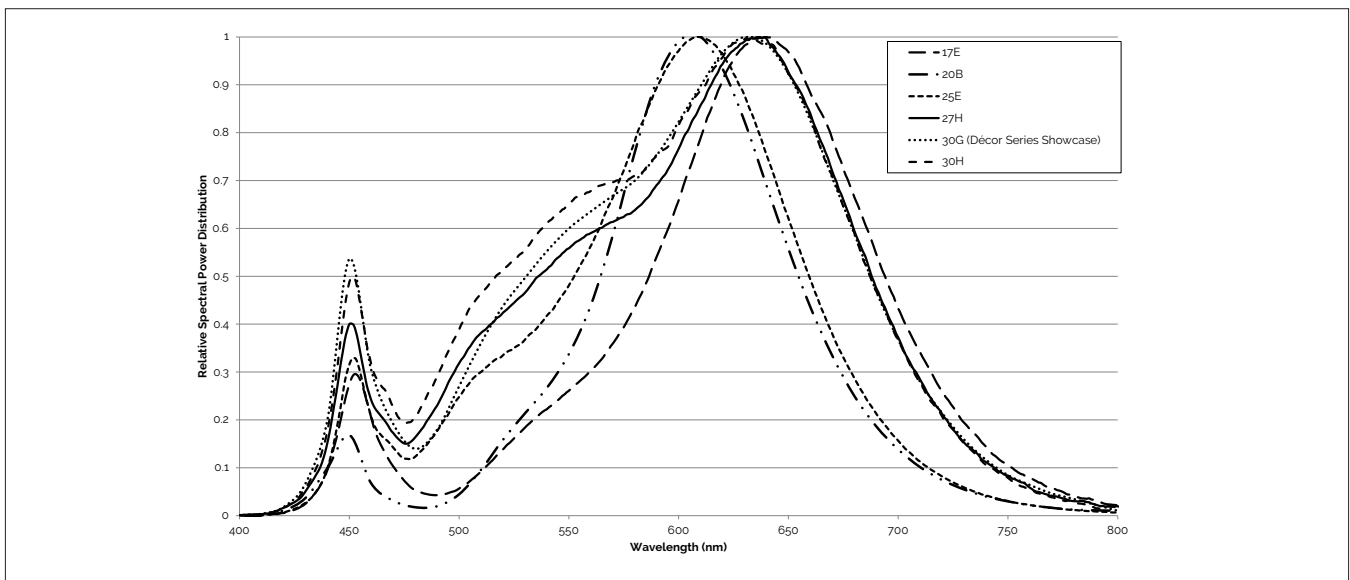

Note for Figure 18:

1. Color spectra measured at nominal current for $T_j = T_c = 25^\circ\text{C}$.

Color Binning Information

Figure 20: Warm and Neutral White Test Bins in xy Color Space

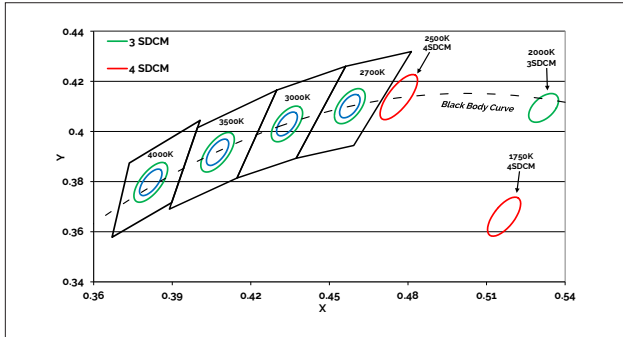

Note: Pulsed Test Conditions. $T_c = 25^\circ\text{C}$

Table 8: Warm and Neutral White xy Bin Coordinates and Associated Typical CCT

Bin Code	1750K	2000K	2500K	2700K	3000K ¹	3500K ¹	4000K ¹
ANSI Bin (for reference only)	-	-	-	(2580K - 2870K)	(2870K - 3220K)	(3220K - 3710K)	(3710K - 4260K)
73 (3 SDCM)	-	-	-	(2651K - 2794K)	(2968K - 3136K)	(3369K - 3586K)	(3851K - 4130K)
72 (2 SDCM)	-	-	-	(2674K - 2769K)	(2995K - 3107K)	(3404K - 3548K)	(3895K - 4081K)
Center Point (x,y)	(0.5167, 0.336)	(0.5280, 0.4100)	(0.4765, 0.4137)	(0.4578, 0.4101)	(0.4338, 0.403) (0.4465, 0.4024) ²	(0.4073, 0.3917)	(0.3818, 0.3797)

Note for Table 8:

- Color Binning information excludes Décor Series Class A products. Please contact your Bridgelux Sales Representative for more information.
- Center Point for Décor Series Showcase.

Figure 21: Graph of Cool White Test Bins in xy Color Space

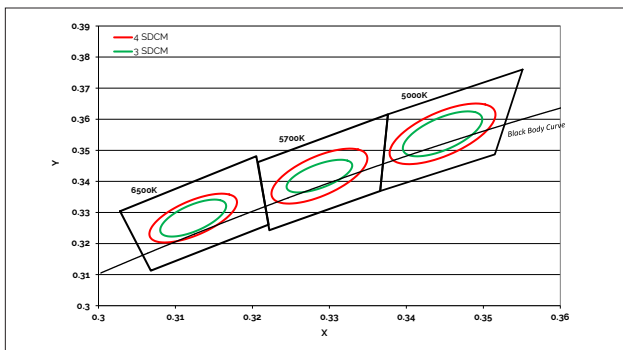

Note: Pulsed Test Conditions. $T_c = 25^\circ\text{C}$

Table 9: Cool White xy Bin Coordinates and Associated Typical CCT (product is hot targeted to $T_c = 85^\circ\text{C}$)

Bin Code	5000K	5700K	6500K
ANSI Bin (for reference only)	(4745K - 5311K)	(5312K - 6022K)	(6022K - 7042K)
74 (4 SDCM)	(4801K - 5282K)	(5829K - 5481K)	(6270K - 6765K)
73 (3 SDCM)	(4835K - 5215K)	(5490K - 5820K)	(6250K - 6745K)
Center Point (x,y)	(0.3447, 0.3553)	(0.3287, 0.3417)	(0.3123, 0.3282)

Packaging and Labeling

Figure 22: Drawing for V18 Packaging Tube

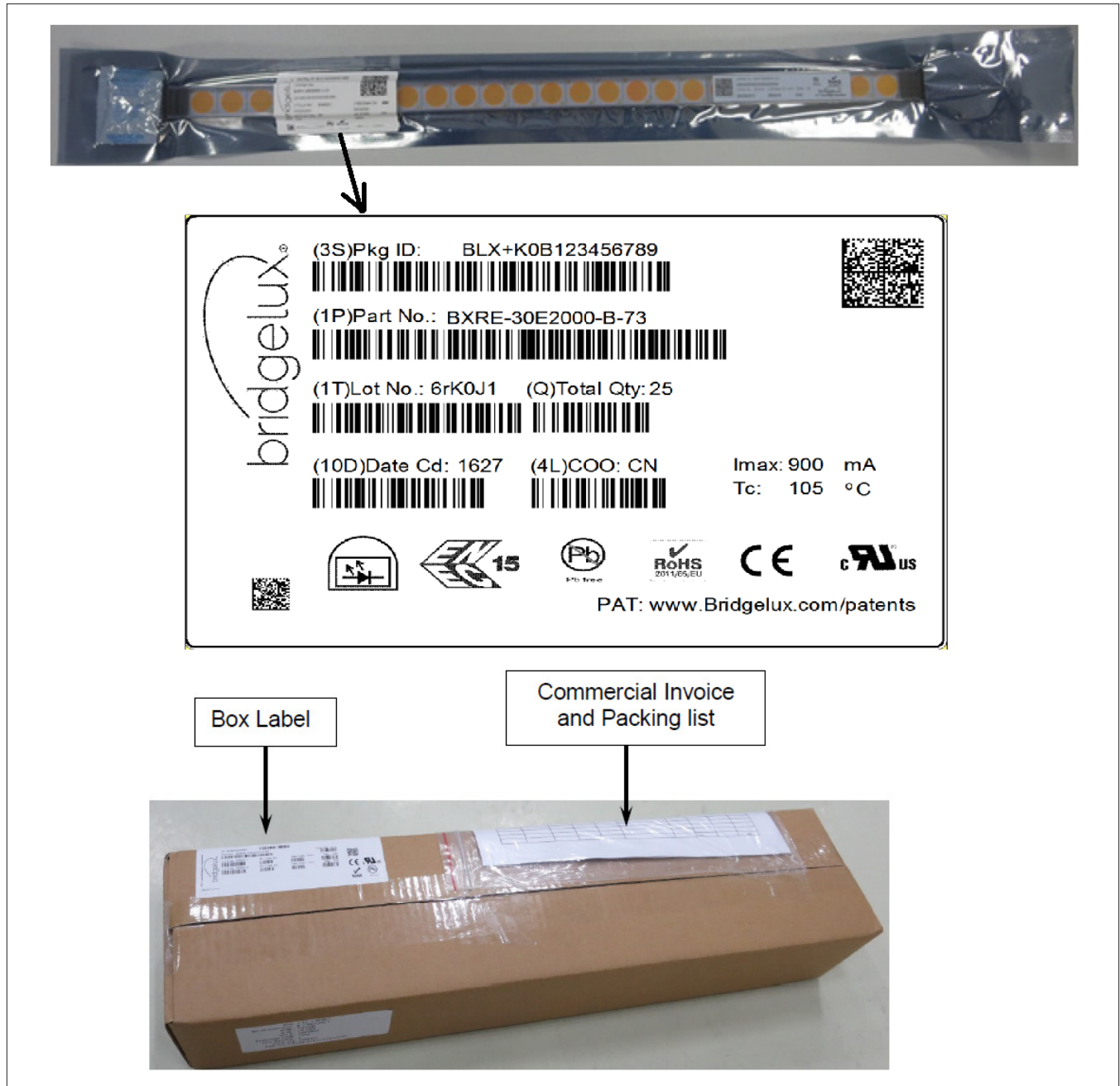

Notes for Figure 22:

1. Each tube holds 20 V18 COB arrays.
2. One tube is sealed in an anti-static bag. Four bags are placed in a shipping box. Depending on quantities ordered, a bigger shipping box, containing four boxes may be used to ship products.
3. Each bag and box is to be labeled as shown above.
4. Dimensions for each tube are 26.3 (W) x 9.5(H) x 510 (L). Dimensions for the anti-static bag are 75 (W) x 615 (L) x 3.1 (T) mm. Dimensions for the shipping box are 58.7 x 13.3 x 7.9 cm

Packaging and Labeling

Figure 23: Gen. 7 Product Labeling

Bridgelux COB arrays have laser markings on the back side of the substrate to help with product identification. In addition to the product identification markings, Bridgelux COB arrays also contain markings for internal Bridgelux manufacturing use only. The image below shows which markings are for customer use and which ones are for Bridgelux internal use only. The Bridgelux internal manufacturing markings are subject to change without notice, however these will not impact the form, function or performance of the COB array.



Design Resources

Application Notes

Bridgelux has developed a comprehensive set of application notes and design resources to assist customers in successfully designing with the V Series product family of LED array products. For all available application notes visit www.bridgelux.com.

Optical Source Models

Optical source models and ray set files are available for all Bridgelux products. For a list of available formats, visit www.bridgelux.com.

3D CAD Models

Three dimensional CAD models depicting the product outline of all Bridgelux V Series LED arrays are available in both IGS and STEP formats. Please contact your Bridgelux sales representative for assistance.

LM80

LM80 testing has been completed and the LM80 report is now available. Please contact your Bridgelux sales representative for LM-80 report.

Precautions

CAUTION: CHEMICAL EXPOSURE HAZARD

Exposure to some chemicals commonly used in luminaire manufacturing and assembly can cause damage to the LED array. Please consult Bridgelux Application Note AN101 for additional information.

CAUTION: RISK OF BURN

Do not touch the V Series LED array during operation. Allow the array to cool for a sufficient period of time before handling. The V Series LED array may reach elevated temperatures such that could burn skin when touched.

CAUTION

CONTACT WITH LIGHT EMITTING SURFACE (LES)

Avoid any contact with the LES. Do not touch the LES of the LED array or apply stress to the LES (yellow phosphor resin area). Contact may cause damage to the LED array.

Optics and reflectors must not be mounted in contact with the LES (yellow phosphor resin area).

Disclaimers

MINOR PRODUCT CHANGE POLICY

The rigorous qualification testing on products offered by Bridgelux provides performance assurance. Slight cosmetic changes that do not affect form, fit, or function may occur as Bridgelux continues product optimization.

STANDARD TEST CONDITIONS

Unless otherwise stated, array testing is performed at the nominal drive current.

About Bridgelux: Bridging Light and Life™

At Bridgelux, we help companies, industries and people experience the power and possibility of light. Since 2002, we've designed LED solutions that are high performing, energy efficient, cost effective and easy to integrate. Our focus is on light's impact on human behavior, delivering products that create better environments, experiences and returns—both experiential and financial. And our patented technology drives new platforms for commercial and industrial luminaires.

For more information about the company, please visit
bridgelux.com
twitter.com/Bridgelux
facebook.com/Bridgelux
youtube.com/user/Bridgelux
linkedin.com/company/bridgelux-inc-_2
WeChat ID: BridgeluxInChina



46430 Fremont Boulevard
Fremont, CA 94538 U.S.A.
Tel (925) 583-8400
www.bridgelux.com

© 2018 Bridgelux, Inc. All rights reserved 2018. Product specifications are subject to change without notice. Bridgelux, the Bridgelux stylized logo design and Vero are registered trademarks, and Decor Series is a trademark of Bridgelux, Inc. All other trademarks are the property of their respective owners.

Bridgelux Gen 7 V18 Array Series Product Data Sheet DS102 Rev. M (09/2018)