



# Bridgelux® Gen 7 Vero® 10 Array

Product Data Sheet DS90



# Introduction

Vero® Series



Vero® Series is a revolutionary advancement in chip on board (COB) light source technology and innovation. Vero LED light sources simplify luminaire design and manufacturing processes. Vero Chip on Board (COB) LED arrays are available in four LES configurations, engineered to enable new degrees of flexibility and reliability over a broad range of electrical currents. Vero arrays deliver increased lumen density to enable improved beam control and precision lighting with 2 and 3 SDCM color control standard for clean and consistent uniform lighting.

Vero products include an onboard connector port that enables a solder-free electrical interconnect, and simple mounting features for plug-and-play installation.

Bridgelux Décor Series™ is our state-of-the-art color line designed specifically for premium applications, producing unmatched LED light quality with brilliant color-rendering options and pleasing lighting palettes. Bridgelux Décor Series color points are available on Vero® SE Series, Vero® Series, V Series™ and V Series™ HD.

Décor Series™ Class A is based on human response testing, providing color points with a combined GAI and CRI metric.

Décor Series™ Ultra products provide a high CRI of 97 and minimum R9 value of 93, which emphasizes the reds and color tones to which the human eye is most receptive - perfect for the most luxurious retail shops and world renowned museums. Décor Series Ultra is designed as a replacement for halogen lamps.

Décor Series™ Street and Landmark is designed to be a direct replacement for high pressure sodium lamps.

Décor Series™ Showcase is the optimal solution for replacing ceramic metal halide lamps, incorporating the same pure white light with enhanced spectrum coverage and higher efficacy.

## Features

- Efficacy of 155 lm/W typical
- Lumen output performance ranges from 520 to 4,100 lumens
- Broad range of CCT options from 2700K to 6500K
- CRI options include minimum 65, 70, 80, and 90
- 2 and 3 SDCM color control for 2700K-4000K CCT
- Reliable operation at up to 2X nominal drive current
- Radial die pattern and improved lumen density
- Thermally isolated solder pads
- On-board connector port
- Top side part number markings
- V<sub>f</sub> bin code backside marking

## Benefits

- Broad application coverage for interior and exterior lighting
- Flexibility for application driven lighting design requirements
- High quality true color reproduction
- Uniform consistent white light
- Flexibility in design optimization
- Enhanced ease of use and assembly
- Solderless connectivity enables plug & play installation and field upgradability
- Improved inventory management and quality control



# Contents

Product Feature Map	2
Product Nomenclature	2
Product Selection Guide	3
Performance at Commonly Used Drive Currents	10
Electrical Characteristics	19
Eye Safety	20
Absolute Maximum Ratings	21
Performance Curves	22
Typical Radiation Pattern	25
Typical Color Spectrum	26
Mechanical Dimensions	27
Color Binning Information	28
Packaging and Labeling	29
Design Resources	31
Precautions	31
Disclaimers	31
About Bridgelux	32

# Product Feature Map

Vero 10 is the smallest form factor in the Vero family of next generation solid state light sources. In addition to delivering the performance and light quality required for many lighting applications, Vero incorporates several

features to simplify the design integration and manufacturing process, accelerate time to market and reduce system costs. Please visit [www.bridgelux.com](http://www.bridgelux.com) for more information on the Vero Series family of products.

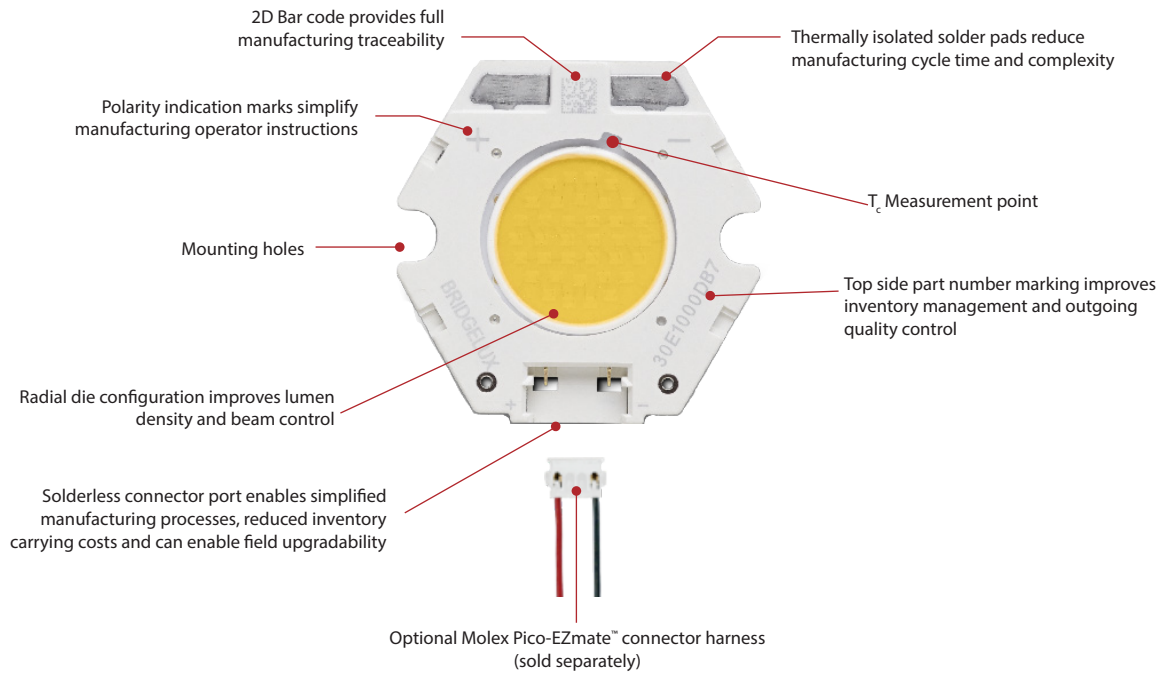

## Product Nomenclature

The part number designation for Bridgelux Vero LED arrays is explained as follows:

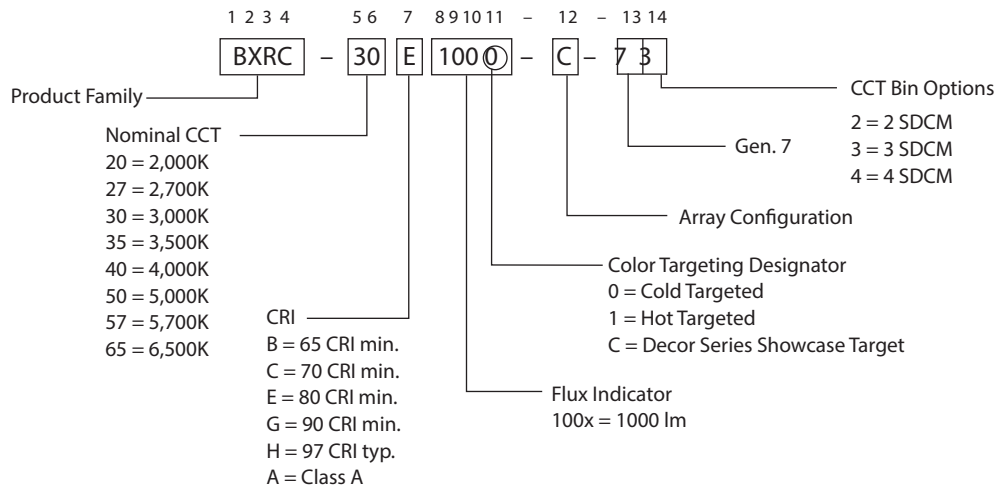

# Product Selection Guide

The following product configurations are available:

Table 1: Selection Guide, Pulsed Measurement Data ( $T_j = T_c = 25^\circ\text{C}$ )

Part Number	Nominal CCT <sup>1</sup> (K)	CRI <sup>2</sup>	Nominal Drive Current <sup>3</sup> (mA)	Typical Pulsed Flux <sup>4,5,6</sup> $T_c = 25^\circ\text{C}$ (lm)	Minimum Pulsed Flux <sup>6,7</sup> $T_c = 25^\circ\text{C}$ (lm)	Typical $V_f$ (V)	Typical Power (W)	Typical Efficacy (lm/W)
BXRC-20B1000-B-73	2000	65	270	1365	1201	34.8	9.4	145
BXRC-20B1000-D-73	2000	65	350	1322	1163	26.0	9.1	145
BXRC-27E1000-B-7X	2700	80	270	1394	1226	34.8	9.4	148
BXRC-27E1000-C-7X	2700	80	360	1858	1635	34.8	12.5	148
BXRC-27E1000-D-7X	2700	80	350	1350	1188	26.0	9.1	148
BXRC-27G10H0-B-7X	2700	90	270	1203	1058	34.8	9.4	128
BXRC-27G10H0-C-7X	2700	90	360	1604	1411	34.8	12.5	128
BXRC-27G10H0-D-7X	2700	90	350	1165	1025	26.0	9.1	128
BXRC-27G1000-B-7X	2700	90	270	1161	1022	34.8	9.4	124
BXRC-27G1000-C-7X	2700	90	360	1548	1363	34.8	12.5	124
BXRC-27G1000-D-7X	2700	90	350	1125	990	26.0	9.1	124
BXRC-27H1000-B-7x	2700	97	270	1006	886	34.8	9.4	107
BXRC-27H1000-C-7x	2700	97	360	1342	1181	34.8	12.5	107
BXRC-27H1000-D-7x	2700	97	350	975	858	26.0	9.1	107
BXRC-30C1001-B-74	3000	70	270	1607	1414	34.8	9.4	171
BXRC-30C1001-C-74	3000	70	360	2142	1885	34.8	12.5	171
BXRC-30C1001-D-74	3000	70	350	1556	1369	26.0	9.1	171
BXRC-30E1000-B-7X	3000	80	270	1452	1277	34.8	9.4	155
BXRC-30E1000-C-7X	3000	80	360	1936	1703	34.8	12.5	155
BXRC-30E1000-D-7X	3000	80	350	1406	1237	26.0	9.1	155
BXRC-30G10H0-B-7X	3000	90	270	1268	1116	34.8	9.4	135
BXRC-30G10H0-C-7X	3000	90	360	1691	1488	34.8	12.5	135
BXRC-30G10H0-D-7X	3000	90	350	1229	1081	26.0	9.1	135
BXRC-30G1000-B-7X	3000	90	270	1210	1065	34.8	9.4	129
BXRC-30G1000-C-7X	3000	90	360	1613	1419	34.8	12.5	129
BXRC-30G1000-D-7X	3000	90	350	1172	1031	26.0	9.1	129
BXRC-30G100C-B-73	3000	90	270	1123	988	34.8	9.4	119
BXRC-30G100C-D-73	3000	90	350	1087	957	26.0	9.1	119
BXRC-30H1000-B-7x	3000	97	270	1084	954	34.8	9.4	115
BXRC-30H1000-C-7x	3000	97	360	1445	1272	34.8	12.5	115
BXRC-30H1000-D-7x	3000	97	350	1050	924	26.0	9.1	115
BXRC-30A1001-B-73 <sup>8,9</sup>	3000	93	270	1090	959	34.8	9.4	116

Notes for Table 1:

- Nominal CCT as defined by ANSI C78.377-2011. Products with a CCT of 5000K-6500K are hot targeted to  $T_c = 85^\circ\text{C}$ .
- CRI values are typical for Decor Series Ultra and Decor Series Class A products. CRI values are minimums for all other products. Minimum R9 value for 80 CRI products is 0, the minimum R9 value for 90 CRI products is 50, the minimum R9 value for 97 CRI products is 93. Bridgelux maintains a  $\pm 3$  tolerance on CRI and R9 values.
- Drive current is referred to as nominal drive current.
- Products tested under pulsed condition (10ms pulse width) at nominal test current where  $T_j$  (junction temperature) =  $T_c$  (case temperature) =  $25^\circ\text{C}$ .
- Typical performance values are provided as a reference only and are not a guarantee of performance.
- Bridgelux maintains a  $\pm 7\%$  tolerance on flux measurements.
- Minimum flux values at the nominal test current are guaranteed by 100% test.
- Nominal CCT is defined by the Lighting Research Center's Class A definition. The center of the Class A color bin is on the corresponding isothermal line.
- GAI value is 80. To help ensure optimal fixture level performance, GAI is measured at the fixture level, on axis, at a case temperature of  $70^\circ\text{C}$ . GAI may vary depending on fixture design and performance.

# Product Selection Guide

Table 1: Selection Guide, Pulsed Measurement Data ( $T_j = T_c = 25^\circ\text{C}$ ) (continued)

Part Number	Nominal CCT <sup>1</sup> (K)	CRI <sup>2</sup>	Nominal Drive Current <sup>3</sup> (mA)	Typical Pulsed Flux <sup>4,5,6</sup> $T_c = 25^\circ\text{C}$ (lm)	Minimum Pulsed Flux <sup>6,7</sup> $T_c = 25^\circ\text{C}$ (lm)	Typical $V_f$ (V)	Typical Power (W)	Typical Efficacy (lm/W)
BXRC-30A1001-C-73 <sup>8,9</sup>	3000	93	360	1453	1279	34.8	12.5	116
BXRC-30A1001-D-73 <sup>8,9</sup>	3000	93	350	1056	929	26.0	9.1	116
BXRC-35E1000-B-7X	3500	80	270	1500	1320	34.8	9.4	160
BXRC-35E1000-C-7X	3500	80	360	2000	1760	34.8	12.5	160
BXRC-35E1000-D-7X	3500	80	350	1453	1278	26.0	9.1	160
BXRC-35G1000-B-7X	3500	90	270	1248	1099	34.8	9.4	133
BXRC-35G1000-C-7X	3500	90	360	1665	1465	34.8	12.5	133
BXRC-35G1000-D-7X	3500	90	350	1209	1064	26.0	9.1	133
BXRC-35A1001-B-73 <sup>8,9</sup>	3500	93	270	1175	1034	34.8	9.4	125
BXRC-35A1001-C-73 <sup>8,9</sup>	3500	93	360	1566	1378	34.8	12.5	125
BXRC-35A1001-D-73 <sup>8,9</sup>	3500	93	350	1138	1001	26.0	9.1	125
BXRC-40C1001-B-74	4000	70	270	1635	1439	34.8	9.4	174
BXRC-40C1001-C-74	4000	70	360	2180	1918	34.8	12.5	174
BXRC-40C1001-D-74	4000	70	350	1583	1393	26.0	9.1	174
BXRC-40E1000-B-7X	4000	80	270	1510	1329	34.8	9.4	161
BXRC-40E1000-C-7X	4000	80	360	2013	1771	34.8	12.5	161
BXRC-40E1000-D-7X	4000	80	350	1462	1287	26.0	9.1	161
BXRC-40G1000-B-7X	4000	90	270	1297	1141	34.8	9.4	138
BXRC-40G1000-C-7X	4000	90	360	1729	1522	34.8	12.5	138
BXRC-40G1000-D-7X	4000	90	350	1256	1105	26.0	9.1	138
BXRC-40H1000-B-7x	4000	97	270	1109	976	34.8	9.4	118
BXRC-40H1000-C-7x	4000	97	360	1478	1301	34.8	12.5	118
BXRC-40H1000-D-7x	4000	97	350	1074	945	26.0	9.1	118
BXRC-40A1001-B-73 <sup>8,9</sup>	4000	93	270	1250	1100	34.8	9.4	133
BXRC-40A1001-C-73 <sup>8,9</sup>	4000	93	360	1666	1466	34.8	12.5	133
BXRC-40A1001-D-73 <sup>8,9</sup>	4000	93	350	1210	1065	26.0	9.1	133
BXRC-50C1001-B-74	5000	70	270	1655	1456	34.8	9.4	176
BXRC-50C1001-C-74	5000	70	360	2207	1942	34.8	12.5	176
BXRC-50C1001-D-74	5000	70	350	1603	1410	26.0	9.1	176
BXRC-50E1001-B-74	5000	80	270	1558	1371	34.8	9.4	166
BXRC-50E1001-C-74	5000	80	360	2078	1828	34.8	12.5	166
BXRC-50E1001-D-74	5000	80	350	1509	1328	26.0	9.1	166
BXRC-50G1001-B-74	5000	90	270	1316	1158	34.8	9.4	140
BXRC-50G1001-C-74	5000	90	360	1755	1544	34.8	12.5	140
BXRC-50G1001-D-74	5000	90	350	1275	1122	26.0	9.1	140

Notes for Table 1:

- Nominal CCT as defined by ANSI C78.377-2011. Products with a CCT of 5000K-6500K are hot targeted to  $T_c = 85^\circ\text{C}$ .
- CRI values are typical for Decor Series Ultra and Decor Series Class A products. CRI values are minimums for all other products. Minimum R9 value for 80 CRI products is 0, the minimum R9 value for 90 CRI products is 50, the minimum R9 value for 97 CRI products is 93. Bridgelux maintains a  $\pm 3$  tolerance on CRI and R9 values.
- Drive current is referred to as nominal drive current.
- Products tested under pulsed condition (10ms pulse width) at nominal test current where  $T_j$  (junction temperature) =  $T_c$  (case temperature) =  $25^\circ\text{C}$ .
- Typical performance values are provided as a reference only and are not a guarantee of performance.
- Bridgelux maintains a  $\pm 7\%$  tolerance on flux measurements.
- Minimum flux values at the nominal test current are guaranteed by 100% test.
- Nominal CCT is defined by the Lighting Research Center's Class A definition. The center of the Class A color bin is on the corresponding isothermal line.
- GAI value is 80. To help ensure optimal fixture level performance, GAI is measured at the fixture level, on axis, at a case temperature of  $70^\circ\text{C}$ . GAI may vary depending on fixture design and performance.

# Product Selection Guide

Table 1: Selection Guide, Pulsed Measurement Data ( $T_j = T_c = 25^\circ\text{C}$ ) (continued)

Part Number	Nominal CCT <sup>1</sup> (K)	CRI <sup>2</sup>	Nominal Drive Current <sup>3</sup> (mA)	Typical Pulsed Flux <sup>4,5,6</sup> $T_c = 25^\circ\text{C}$ (lm)	Minimum Pulsed Flux <sup>6,7</sup> $T_c = 25^\circ\text{C}$ (lm)	Typical $V_f$ (V)	Typical Power (W)	Typical Efficacy (lm/W)
BXRC-50G1001-D-74	5000	90	350	1275	1122	26.0	9.1	140
BXRC-57C1001-B-74	5700	70	270	1597	1405	34.8	9.4	170
BXRC-57C1001-C-74	5700	70	360	2129	1874	34.8	12.5	170
BXRC-57C1001-D-74	5700	70	350	1547	1361	26.0	9.1	170
BXRC-57E1001-B-74	5700	80	270	1541	1356	34.8	9.4	164
BXRC-57E1001-C-74	5700	80	360	2055	1808	34.8	12.5	164
BXRC-57E1001-D-74	5700	80	350	1492	1313	26.0	9.1	164
BXRC-65C1001-B-74	6500	70	270	1626	1431	34.8	9.4	173
BXRC-65C1001-C-74	6500	70	360	2168	1908	34.8	12.5	173
BXRC-65C1001-D-74	6500	70	350	1575	1386	26.0	9.1	173
BXRC-65E1001-B-74	6500	80	270	1569	1381	34.8	9.4	167
BXRC-65E1001-C-74	6500	80	360	2092	1841	34.8	12.5	167
BXRC-65E1001-D-74	6500	80	350	1520	1337	26.0	9.1	167

Notes for Table 1:

- Nominal CCT as defined by ANSI C78.377-2011. Products with a CCT of 5000K-6500K are hot targeted to  $T_c = 85^\circ\text{C}$ .
- CRI values are typical for Decor Series Ultra and Decor Series Class A products. CRI values are minimums for all other products. Minimum R9 value for 80 CRI products is 0, the minimum R9 value for 90 CRI products is 50, the minimum R9 value for 97 CRI products is 93. Bridgelux maintains a  $\pm 3$  tolerance on CRI and R9 values.
- Drive current is referred to as nominal drive current.
- Products tested under pulsed condition (10ms pulse width) at nominal test current where  $T_j$  (junction temperature) =  $T_c$  (case temperature) =  $25^\circ\text{C}$ .
- Typical performance values are provided as a reference only and are not a guarantee of performance.
- Bridgelux maintains a  $\pm 7\%$  tolerance on flux measurements.
- Minimum flux values at the nominal test current are guaranteed by 100% test.
- Nominal CCT is defined by the Lighting Research Center's Class A definition. The center of the Class A color bin is on the corresponding isothermal line.
- GAI value is 80. To help ensure optimal fixture level performance, GAI is measured at the fixture level, on axis, at a case temperature of  $70^\circ\text{C}$ . GAI may vary depending on fixture design and performance.

# Product Selection Guide

Table 2: Selection Guide, Stabilized DC Performance ( $T_c = 70^\circ\text{C}$ ) <sup>7,8</sup>

Part Number	Nominal CCT <sup>1</sup> (K)	GAI <sup>2</sup>	CRI <sup>3</sup>	Nominal Drive Current <sup>4</sup> (mA)	Typical DC Flux <sup>5,6</sup> $T_c = 70^\circ\text{C}$ (lm)	Minimum DC Flux <sup>6,9</sup> $T_c = 70^\circ\text{C}$ (lm)	Typical $V_f$ (V)	Typical Power (W)	Typical Efficacy (lm/W)
BXRC-30A1001-B-73	3000	80	93	270	1014	844	34.3	9.3	110
BXRC-30A1001-C-73	3000	80	93	360	1352	1125	34.3	12.3	110
BXRC-30A1001-D-73	3000	80	93	350	982	817	25.5	8.9	110
BXRC-35A1001-B-73	3500	80	93	270	1092	1162	34.3	9.3	118
BXRC-35A1001-C-73	3500	80	93	360	1456	1549	34.3	12.3	118
BXRC-35A1001-D-73	3500	80	93	350	1058	1125	25.5	8.9	119
BXRC-40A1001-B-73	4000	80	93	270	1162	967	34.3	9.3	126
BXRC-40A1001-C-73	4000	80	93	360	1550	1289	34.3	12.3	126
BXRC-40A1001-D-73	4000	80	93	350	1126	936	25.5	8.9	126

Notes for Table 2:

1. Nominal CCT is defined by the Lighting Research Center's Class A definition. The center of the Class A color bin is on the corresponding isothermal line.
2. To help ensure optimal fixture level performance, GAI is measured at the fixture level, on axis, at a case temperature of  $70^\circ\text{C}$ . GAI may vary depending on fixture design and performance.
3. CRI Values are specified as typical.
4. Drive current is referred to as nominal drive current.
5. Typical performance values are provided as a reference only and are not a guarantee of performance.
6. Bridgelux maintains a  $\pm 7\%$  tolerance on flux measurements.
7. Typical stabilized DC performance values are provided as reference only and are not a guarantee of performance.
8. Typical performance is estimated based on operation under DC (direct current) with LED array mounted onto a heat sink with thermal interface material and the case temperature maintained at specified temperature. Based on Bridgelux test setup, values may vary depending on the thermal design of the luminaire and/or the exposed environment to which the product is subjected.
9. Minimum flux values at elevated temperatures are provided for reference only and are not guaranteed by 100% production testing. Based on Bridgelux test setup, values may vary depending on the thermal design of the luminaire and/or the exposed environment to which the product is subjected.



# Product Selection Guide

Table 3: Selection Guide, Stabilized DC Performance ( $T_c = 85^\circ\text{C}$ )<sup>4,5</sup>

Part Number	Nominal CCT <sup>1</sup> (K)	CRI <sup>2</sup>	Nominal Drive Current <sup>3</sup> (mA)	Typical DC Flux <sup>4,5</sup> $T_c = 85^\circ\text{C}$ (lm)	Minimum DC Flux <sup>6</sup> $T_c = 85^\circ\text{C}$ (lm)	Typical $V_f$ (V)	Typical Power (W)	Typical Efficacy (lm/W)
BXRC-20B1000-B-73	2000	65	270	1228	1081	33.8	9.1	135
BXRC-20B1000-D-73	2000	65	350	1189	1047	25.3	8.9	134
BXRC-27E1000-B-7X	2700	80	270	1254	1104	33.8	9.1	137
BXRC-27E1000-C-7X	2700	80	360	1672	1472	33.8	12.2	137
BXRC-27E1000-D-7X	2700	80	350	1215	1069	25.3	8.9	137
BXRC-27G10H0-B-7X	2700	90	270	1082	953	33.8	9.1	118
BXRC-27G10H0-C-7X	2700	90	360	1443	1270	33.8	12.2	118
BXRC-27G10H0-D-7X	2700	90	350	1048	923	25.3	8.9	118
BXRC-27G1000-B-7X	2700	90	270	1045	920	33.8	9.1	114
BXRC-27G1000-C-7X	2700	90	360	1394	1226	33.8	12.2	114
BXRC-27G1000-D-7X	2700	90	350	1012	891	25.3	8.9	114
BXRC-27H1000-B-7x	2700	97	270	906	797	34.8	9.4	96
BXRC-27H1000-C-7x	2700	97	360	1208	1063	34.8	12.5	96
BXRC-27H1000-D-7x	2700	97	350	877	772	34.8	12.2	72
BXRC-30C1001-B-74	3000	70	270	1446	1273	33.8	9.1	158
BXRC-30C1001-C-74	3000	70	360	1928	1697	33.8	12.2	158
BXRC-30C1001-D-74	3000	70	350	1400	1232	25.3	8.9	158
BXRC-30E1000-B-7X	3000	80	270	1307	1150	33.8	9.1	143
BXRC-30E1000-C-7X	3000	80	360	1742	1533	33.8	12.2	143
BXRC-30E1000-D-7X	3000	80	350	1265	1114	25.3	8.9	143
BXRC-30G10H0-B-7X	3000	90	270	1142	1005	33.8	9.1	125
BXRC-30G10H0-C-7X	3000	90	360	1522	1339	33.8	12.2	125
BXRC-30G10H0-D-7X	3000	90	350	1106	973	25.3	8.9	125
BXRC-30G1000-B-7X	3000	90	270	1089	958	33.8	9.1	119
BXRC-30G1000-C-7X	3000	90	360	1452	1277	33.8	12.2	119
BXRC-30G1000-D-7X	3000	90	350	1054	928	25.3	8.9	119
BXRC-30G100C-B-73	3000	90	270	1010	889	34.0	9.2	110
BXRC-30G100C-D-73	3000	90	350	979	861	25.3	8.9	111
BXRC-30H1000-B-7x	3000	97	270	976	858	34.8	9.4	104
BXRC-30H1000-C-7x	3000	97	360	1301	1145	34.8	12.5	104
BXRC-30H1000-D-7x	3000	97	350	945	831	34.8	12.2	78
BXRC-30A1001-B-73 <sup>7,8</sup>	3000	93	270	981	863	34.8	9.4	104
BXRC-30A1001-C-73 <sup>7,8</sup>	3000	93	360	1308	1151	34.8	12.5	104
BXRC-30A1001-D-73 <sup>7,8</sup>	3000	93	350	950	836	34.8	12.2	78
BXRC-35E1000-B-7X	3500	80	270	1350	1188	33.8	9.1	148

Notes for Table 3:

- Nominal CCT as defined by ANSI C78.377-2011. Products with a CCT of 5000K-6500K are hot targeted to  $T_c = 85^\circ\text{C}$ .
- All CRI values are measured at  $T_c = T_j = 25^\circ\text{C}$ . CRI values are typical for Decor Series Ultra and Decor Series Class A products. CRI values are minimums for all other products. Minimum R9 value for 80 CRI products is 0, the minimum R9 value for 90 CRI products is 50, the minimum R9 value for 97 CRI products is 93. Bridgelux maintains a  $\pm 3$  tolerance on CRI and R9 values.
- Drive current is referred to as nominal drive current.
- Typical stabilized DC performance values are provided as reference only and are not a guarantee of performance.
- Typical performance is estimated based on operation under DC (direct current) with LED array mounted onto a heat sink with thermal interface material and the case temperature maintained at  $85^\circ\text{C}$ . Based on Bridgelux test setup, values may vary depending on the thermal design of the luminaire and/or the exposed environment to which the product is subjected.
- Minimum flux values at elevated temperatures are provided for reference only and are not guaranteed by 100% production testing. Based on Bridgelux test setup, values may vary depending on the thermal design of the luminaire and/or the exposed environment to which the product is subjected.
- Nominal CCT is defined by the Lighting Research Center's Class A definition. The center of the Class A color bin is on the corresponding isothermal line.
- GAI value is 80. To help ensure optimal fixture level performance, GAI is measured at the fixture level, on axis, at a case temperature of  $70^\circ\text{C}$ . GAI may vary depending on fixture design and performance.

# Product Selection Guide

Table 3: Selection Guide, Stabilized DC Performance ( $T_c = 85^\circ\text{C}$ )<sup>4,5</sup> (continued)

Part Number	Nominal CCT <sup>1</sup> (K)	CRI <sup>2</sup>	Nominal Drive Current <sup>3</sup> (mA)	Typical DC Flux <sup>4,5</sup> $T_c = 85^\circ\text{C}$ (lm)	Minimum DC Flux <sup>6</sup> $T_c = 85^\circ\text{C}$ (lm)	Typical $V_f$ (V)	Typical Power (W)	Typical Efficacy (lm/W)
BXRC-35E1000-C-7X	3500	80	360	1800	1584	33.8	12.2	148
BXRC-35E1000-D-7X	3500	80	350	1308	1151	25.3	8.9	148
BXRC-35G1000-B-7X	3500	90	270	1124	989	33.8	9.1	123
BXRC-35G1000-C-7X	3500	90	360	1498	1318	33.8	12.2	123
BXRC-35G1000-D-7X	3500	90	350	1088	958	25.0	8.8	124
BXRC-35A1001-B-73 <sup>7,8</sup>	3500	93	270	1057	930	33.8	9.1	116
BXRC-35A1001-C-73 <sup>7,8</sup>	3500	93	360	1409	1240	33.8	12.2	116
BXRC-35A1001-D-73 <sup>7,8</sup>	3500	93	350	1024	901	25.0	8.8	117
BXRC-40C1001-B-74	4000	70	270	1471	1295	33.8	9.1	161
BXRC-40C1001-C-74	4000	70	360	1962	1726	33.8	12.2	161
BXRC-40C1001-D-74	4000	70	350	1425	1254	25.3	8.9	161
BXRC-40E1000-B-7X	4000	80	270	1359	1196	33.8	9.1	149
BXRC-40E1000-C-7X	4000	80	360	1812	1594	33.8	12.2	149
BXRC-40E1000-D-7X	4000	80	350	1316	1158	25.0	8.8	150
BXRC-40G1000-B-7X	4000	90	270	1167	1027	33.8	9.1	128
BXRC-40G1000-C-7X	4000	90	360	1556	1369	33.8	12.2	128
BXRC-40G1000-D-7X	4000	90	350	1130	995	25.0	8.8	129
BXRC-40H1000-B-7x	4000	97	270	998	878	33.8	9.1	109
BXRC-40H1000-C-7x	4000	97	360	1330	1171	33.8	12.2	109
BXRC-40H1000-D-7x	4000	97	350	966	850	25.0	8.8	110
BXRC-40A1001-B-73 <sup>7,8</sup>	4000	93	270	1125	990	33.8	9.1	123
BXRC-40A1001-C-73 <sup>7,8</sup>	4000	93	360	1500	1320	33.8	12.2	123
BXRC-40A1001-D-73 <sup>7,8</sup>	4000	93	350	1089	959	25.0	8.8	124
BXRC-50C1001-B-74	5000	70	270	1489	1311	33.8	9.1	163
BXRC-50C1001-C-74	5000	70	360	1986	1748	33.8	12.2	163
BXRC-50C1001-D-74	5000	70	350	1443	1269	25.0	8.8	165
BXRC-50E1001-B-74	5000	80	270	1402	1234	33.8	9.1	154
BXRC-50E1001-C-74	5000	80	360	1870	1645	33.8	12.2	154
BXRC-50E1001-D-74	5000	80	350	1358	1195	25.0	8.8	155
BXRC-50G1001-B-74	5000	90	270	1185	1042	33.8	9.1	130
BXRC-50G1001-C-74	5000	90	360	1579	1390	33.8	12.2	130
BXRC-50G1001-D-74	5000	90	350	1147	1010	25.0	8.8	131

Notes for Table 3:

- Nominal CCT as defined by ANSI C78.377-2011. Products with a CCT of 5000K-6500K are hot targeted to  $T_c = 85^\circ\text{C}$ .
- All CRI values are measured at  $T_c = T_c = 25^\circ\text{C}$ . CRI values are typical for Decor Series Ultra and Decor Series Class A products. CRI values are minimums for all other products. Minimum R9 value for 80 CRI products is 0, the minimum R9 value for 90 CRI products is 50, the minimum R9 value for 97 CRI products is 93. Bridgelux maintains a  $\pm 3$  tolerance on CRI and R9 values.
- Drive current is referred to as nominal drive current.
- Typical stabilized DC performance values are provided as reference only and are not a guarantee of performance.
- Typical performance is estimated based on operation under DC (direct current) with LED array mounted onto a heat sink with thermal interface material and the case temperature maintained at  $85^\circ\text{C}$ . Based on Bridgelux test setup, values may vary depending on the thermal design of the luminaire and/or the exposed environment to which the product is subjected.
- Minimum flux values at elevated temperatures are provided for reference only and are not guaranteed by 100% production testing. Based on Bridgelux test setup, values may vary depending on the thermal design of the luminaire and/or the exposed environment to which the product is subjected.
- Nominal CCT is defined by the Lighting Research Center's Class A definition. The center of the Class A color bin is on the corresponding isothermal line.
- GAI value is 80. To help ensure optimal fixture level performance, GAI is measured at the fixture level, on axis, at a case temperature of  $70^\circ\text{C}$ . GAI may vary depending on fixture design and performance.

# Product Selection Guide

Table 3: Selection Guide, Stabilized DC Performance ( $T_c = 85^\circ\text{C}$ )<sup>4,5</sup>

Part Number	Nominal CCT <sup>1</sup> (K)	CRI <sup>2</sup>	Nominal Drive Current <sup>3</sup> (mA)	Typical DC Flux <sup>4,5</sup> $T_c = 85^\circ\text{C}$ (lm)	Minimum DC Flux <sup>6</sup> $T_c = 85^\circ\text{C}$ (lm)	Typical $V_f$ (V)	Typical Power (W)	Typical Efficacy (lm/W)
BXRC-57C1001-B-74	5700	70	270	1437	1265	33.8	9.1	157
BXRC-57C1001-C-74	5700	70	360	1916	1686	33.8	12.2	157
BXRC-57C1001-D-74	5700	70	350	1392	1225	25.0	8.8	159
BXRC-57E1001-B-74	5700	80	270	1387	1220	33.8	9.1	152
BXRC-57E1001-C-74	5700	80	360	1849	1627	33.8	12.2	152
BXRC-57E1001-D-74	5700	80	350	1343	1182	25.0	8.8	153
BXRC-65C1001-B-74	6500	70	270	1463	1288	33.8	9.1	160
BXRC-65C1001-C-74	6500	70	360	1951	1717	33.8	12.2	160
BXRC-65C1001-D-74	6500	70	350	1417	1247	25.0	8.8	162
BXRC-65E1001-B-74	6500	80	270	1412	1243	33.8	9.1	155
BXRC-65E1001-C-74	6500	80	360	1883	1657	33.8	12.2	155
BXRC-65E1001-D-74	6500	80	350	1368	1204	25.0	8.8	156

Notes for Table 3:

- Nominal CCT as defined by ANSI C78.377-2011. Products with a CCT of 5000K-6500K are hot targeted to  $T_c = 85^\circ\text{C}$ .
- All CRI values are measured at  $T_c = T_s = 25^\circ\text{C}$ . CRI values are typical for Decor Series Ultra and Decor Series Class A products. CRI values are minimums for all other products. Minimum R9 value for 80 CRI products is 0, the minimum R9 value for 90 CRI products is 50, the minimum R9 value for 97 CRI products is 93. Bridgelux maintains a  $\pm 3$  tolerance on CRI and R9 values.
- Drive current is referred to as nominal drive current.
- Typical stabilized DC performance values are provided as reference only and are not a guarantee of performance.
- Typical performance is estimated based on operation under DC (direct current) with LED array mounted onto a heat sink with thermal interface material and the case temperature maintained at  $85^\circ\text{C}$ . Based on Bridgelux test setup, values may vary depending on the thermal design of the luminaire and/or the exposed environment to which the product is subjected.
- Minimum flux values at elevated temperatures are provided for reference only and are not guaranteed by 100% production testing. Based on Bridgelux test setup, values may vary depending on the thermal design of the luminaire and/or the exposed environment to which the product is subjected.
- Nominal CCT is defined by the Lighting Research Center's Class A definition. The center of the Class A color bin is on the corresponding isothermal line.
- GAI value is 80. To help ensure optimal fixture level performance, GAI is measured at the fixture level, on axis, at a case temperature of  $70^\circ\text{C}$ . GAI may vary depending on fixture design and performance.

# Performance at Commonly Used Drive Currents

Vero LED arrays are tested to the specifications shown using the nominal drive currents in Table 1. Vero may also be driven at other drive currents dependent on specific application design requirements. The performance at any drive current can be derived from the current vs. voltage characteristics shown in Figures 1, 2 & 3 and the flux vs. current characteristics shown in Figures 4, 5 & 6. The performance at commonly used drive currents is summarized in Table 4.

Table 4: Product Performance at Commonly Used Drive Currents

Part Number	CRI	Drive Current <sup>1</sup> (mA)	Typical $V_f$ $T_c = 25^\circ\text{C}$ (V)	Typical Power $T_c = 25^\circ\text{C}$ (W)	Typical Flux <sup>2</sup> $T_c = 25^\circ\text{C}$ (lm)	Typical DC Flux <sup>3</sup> $T_c = 85^\circ\text{C}$ (lm)	Typical Efficacy $T_c = 25^\circ\text{C}$ (lm/W)
BXRC-20B1001-B-73	65	135	33.2	4.5	727	653	162
		180	34.0	6.1	953	855	156
		270	34.8	9.4	1365	1228	145
		405	35.6	14.4	2002	1781	139
		540	36.1	19.5	2565	2270	131
BXRC-20B1001-D-73	65	175	24.9	4.4	706	642	162
		233	25.4	5.9	926	832	156
		350	26.0	9.1	1322	1189	145
		525	27.4	14.4	1945	1678	135
		700	28.4	19.9	2492	2099	125
BXRC-27E1000-B-7X	80	135	33.2	4.5	743	667	166
		180	34.0	6.1	974	873	159
		270	34.8	9.4	1394	1254	148
		405	35.6	14.4	2045	1819	142
		540	36.1	19.5	2619	2318	134
BXRC-27E1000-C-7X	80	180	33.2	6.0	988	882	165
		240	34.0	8.2	1294	1150	159
		360	34.8	12.5	1858	1672	148
		540	35.6	19.2	2706	2351	141
		720	36.1	26.0	3456	2959	133
BXRC-27E1000-D-7X	80	175	24.9	4.4	721	655	165
		233	25.4	5.9	945	850	160
		350	26.0	9.1	1350	1215	148
		525	27.4	14.4	1987	1713	138
		700	28.4	19.9	2545	2143	128
BXRC-27G10H0-B-7X	90	135	33.2	4.5	641	576	143
		180	34.0	6.1	840	754	137
		270	34.8	9.4	1203	1082	128
		405	35.6	14.4	1764	1570	122
		540	36.1	19.5	2260	2001	116
BXRC-27G10H0-C-7X	90	180	33.2	6.0	853	761	143
		240	34.0	8.2	1117	992	137
		360	34.8	12.5	1604	1443	128
		540	35.6	19.2	2335	2029	121
		720	36.1	26.0	2983	2553	115
BXRC-27G10H0-D-7X	90	175	24.9	4.4	622	566	143
		233	25.4	5.9	816	734	138
		350	26.0	9.1	1165	1048	128
		525	27.4	14.4	1714	1479	119
		700	28.4	19.9	2197	1850	110

Notes for Table 4:

1. Alternate drive currents are provided for reference only and are not a guarantee of performance.
2. Bridgelux maintains a  $\pm 7\%$  tolerance on flux measurements.
3. Typical stabilized DC performance values are provided as reference only and are not a guarantee of performance.

# Performance at Commonly Used Drive Currents

Table 4: Product Performance at Commonly Used Drive Currents (Continued)

Part Number	CRI	Drive Current <sup>1</sup> (mA)	Typical $V_f$ $T_c = 25^\circ\text{C}$ (V)	Typical Power $T_c = 25^\circ\text{C}$ (W)	Typical Flux <sup>2</sup> $T_c = 25^\circ\text{C}$ (lm)	Typical DC Flux <sup>3</sup> $T_c = 85^\circ\text{C}$ (lm)	Typical Efficacy $T_c = 25^\circ\text{C}$ (lm/W)
BXRC-27G1000-B-7X	90	135	33.2	4.5	619	556	138
		180	34.0	6.1	811	728	133
		270	34.8	9.4	1161	1045	124
		405	35.6	14.4	1704	1516	118
		540	36.1	19.5	2183	1932	112
BXRC-27G1000-C-7X	90	180	33.2	6.0	823	735	138
		240	34.0	8.2	1079	958	132
		360	34.8	12.5	1548	1394	124
		540	35.6	19.2	2255	1959	117
		720	36.1	26.0	2880	2465	111
BXRC-27G1000-D-7X	90	175	24.9	4.4	601	546	138
		233	25.4	5.9	788	708	133
		350	26.0	9.1	1125	1012	124
		525	27.4	14.4	1656	1428	115
		700	28.4	19.9	2121	1786	107
BXRC-27H1000-B-7x	97	135	33.2	4.5	536	482	120
		180	34.0	6.1	703	631	115
		270	34.8	9.4	1006	906	107
		405	35.6	14.4	1477	1314	102
		540	36.1	19.5	1892	1674	97
BXRC-27H1000-C-7x	97	180	33.2	6.0	713	637	119
		240	34.0	8.2	935	830	115
		360	34.8	12.5	1342	1208	107
		540	35.6	19.2	1954	1698	102
		720	36.1	26.0	2496	2137	96
BXRC-27H1000-D-7x	97	175	24.9	4.4	520	473	119
		233	25.4	5.9	683	614	115
		350	26.0	9.1	975	877	107
		525	27.4	14.4	1435	1237	100
		700	28.4	19.9	1838	1548	92
BXRC-30C1001-B-74	70	135	33.2	4.5	856	769	191
		180	34.0	6.1	1123	1007	183
		270	34.8	9.4	1607	1446	171
		405	35.6	14.4	2357	2097	163
		540	36.1	19.5	3020	2673	155
BXRC-30C1001-C-74	70	180	33.2	6.0	1139	1016	191
		240	34.0	8.2	1492	1326	183
		360	34.8	12.5	2142	1928	171
		540	35.6	19.2	3119	2710	162
		720	36.1	26.0	3985	3411	153
BXRC-30C1001-D-74	70	175	24.9	4.4	831	755	190
		233	25.4	5.9	1090	980	184
		350	26.0	9.1	1556	1400	171
		525	27.4	14.4	2290	1975	159
		700	28.4	19.9	2934	2471	148

Notes for Table 4:

1. Alternate drive currents are provided for reference only and are not a guarantee of performance.
2. Bridgelux maintains a  $\pm 7\%$  tolerance on flux measurements.
3. Typical stabilized DC performance values are provided as reference only and are not a guarantee of performance.

# Performance at Commonly Used Drive Currents

Table 4: Product Performance at Commonly Used Drive Currents (Continued)

Part Number	CRI	Drive Current <sup>1</sup> (mA)	Typical $V_f$ $T_c = 25^\circ\text{C}$ (V)	Typical Power $T_c = 25^\circ\text{C}$ (W)	Typical Flux <sup>2</sup> $T_c = 25^\circ\text{C}$ (lm)	Typical DC Flux <sup>3</sup> $T_c = 85^\circ\text{C}$ (lm)	Typical Efficacy $T_c = 25^\circ\text{C}$ (lm/W)
BXRC-30E1000-B-7X	80	135	33.2	4.5	774	695	173
		180	34.0	6.1	1014	910	166
		270	34.8	9.4	1452	1307	155
		405	35.6	14.4	2130	1895	148
		540	36.1	19.5	2728	2415	140
BXRC-30E1000-C-7X	80	180	33.2	6.0	1029	918	172
		240	34.0	8.2	1348	1198	165
		360	34.8	12.5	1936	1742	155
		540	35.6	19.2	2818	2448	146
		720	36.1	26.0	3600	3082	138
BXRC-30E1000-D-7X	80	175	24.9	4.4	751	683	172
		233	25.4	5.9	985	885	166
		350	26.0	9.1	1406	1265	155
		525	27.4	14.4	2069	1785	144
		700	28.4	19.9	2651	2233	133
BXRC-30G10H0-B-7X	90	135	33.2	4.5	676	607	151
		180	34.0	6.1	886	795	145
		270	34.8	9.4	1268	1142	135
		405	35.6	14.4	1861	1655	129
		540	36.1	19.5	2384	2110	122
BXRC-30G10H0-C-7X	90	180	33.2	6.0	899	802	150
		240	34.0	8.2	1178	1047	144
		360	34.8	12.5	1691	1522	135
		540	35.6	19.2	2463	2139	128
		720	36.1	26.0	3146	2693	121
BXRC-30G10H0-D-7X	90	175	24.9	4.4	656	596	150
		233	25.4	5.9	861	774	145
		350	26.0	9.1	1229	1106	135
		525	27.4	14.4	1808	1560	126
		700	28.4	19.9	2317	1951	116
BXRC-30G1000-B-7X	90	135	33.2	4.5	645	579	144
		180	34.0	6.1	845	758	138
		270	34.8	9.4	1210	1089	129
		405	35.6	14.4	1775	1579	123
		540	36.1	19.5	2274	2012	116
BXRC-30G1000-C-7X	90	180	33.2	6.0	858	765	143
		240	34.0	8.2	1124	998	138
		360	34.8	12.5	1613	1452	129
		540	35.6	19.2	2349	2040	122
		720	36.1	26.0	3000	2568	115
BXRC-30G1000-D-7X	90	175	24.9	4.4	626	569	143
		233	25.4	5.9	821	738	139
		350	26.0	9.1	1172	1054	129
		525	27.4	14.4	1725	1487	120
		700	28.4	19.9	2209	1861	111

Notes for Table 4:

1. Alternate drive currents are provided for reference only and are not a guarantee of performance.
2. Bridgelux maintains a  $\pm 7\%$  tolerance on flux measurements.
3. Typical stabilized DC performance values are provided as reference only and are not a guarantee of performance.

# Performance at Commonly Used Drive Currents

Table 4: Product Performance at Commonly Used Drive Currents (Continued)

Part Number	CRI	Drive Current <sup>1</sup> (mA)	Typical $V_f$ $T_c = 25^\circ\text{C}$ (V)	Typical Power $T_c = 25^\circ\text{C}$ (W)	Typical Flux <sup>2</sup> $T_c = 25^\circ\text{C}$ (lm)	Typical DC Flux <sup>3</sup> $T_c = 85^\circ\text{C}$ (lm)	Typical Efficacy $T_c = 25^\circ\text{C}$ (lm/W)
BXRC-30G100C-B-73	90	135	33.2	4.5	598	538	133
		180	34.0	6.1	784	704	128
		270	34.8	9.4	1123	1010	119
		405	35.6	14.4	1647	1465	114
		540	36.1	19.5	2110	1868	108
BXRC-30G100C-D-73	90	175	24.9	4.4	581	528	133
		233	25.4	5.9	762	685	129
		350	26.0	9.1	1087	979	119
		525	27.4	14.4	1600	1380	111
		700	28.4	19.9	2050	1727	103
BXRC-30H1000-B-7x	97	135	33.2	4.5	578	519	129
		180	34.0	6.1	757	679	124
		270	34.8	9.4	1084	976	115
		405	35.6	14.4	1590	1415	110
		540	36.1	19.5	2037	1803	104
BXRC-30H1000-C-7x	97	180	33.2	6.0	768	686	129
		240	34.0	8.2	1007	894	123
		360	34.8	12.5	1445	1301	115
		540	35.6	19.2	2104	1828	109
		720	36.1	26.0	2688	2301	103
BXRC-30H1000-D-7x	97	175	24.9	4.4	561	510	129
		233	25.4	5.9	735	661	124
		350	26.0	9.1	1050	945	115
		525	27.4	14.4	1545	1333	108
		700	28.4	19.9	1980	1667	100
BXRC-30A1001-B-73	93	135	33.2	4.5	581	522	130
		180	34.0	6.1	762	683	124
		270	34.8	9.4	1090	981	116
		405	35.6	14.4	1599	1422	111
		540	36.1	19.5	2049	1813	105
BXRC-30A1001-C-73	93	180	33.2	6.0	773	689	129
		240	34.0	8.2	1012	899	124
		360	34.8	12.5	1453	1308	116
		540	35.6	19.2	2116	1838	110
		720	36.1	26.0	2703	2314	104
BXRC-30A1001-D-73	93	175	24.9	4.4	564	512	129
		233	25.4	5.9	739	665	125
		350	26.0	9.1	1056	950	116
		525	27.4	14.4	1554	1340	108
		700	28.4	19.9	1991	1676	100
BXRC-35E1000-B-7X	80	135	33.2	4.5	799	718	178
		180	34.0	6.1	1048	940	171
		270	34.8	9.4	1500	1350	160
		405	35.6	14.4	2201	1958	152
		540	36.1	19.5	2819	2495	144

Notes for Table 4:

1. Alternate drive currents are provided for reference only and are not a guarantee of performance.
2. Bridgelux maintains a  $\pm 7\%$  tolerance on flux measurements.
3. Typical stabilized DC performance values are provided as reference only and are not a guarantee of performance.

# Performance at Commonly Used Drive Currents

Table 4: Product Performance at Commonly Used Drive Currents (Continued)

Part Number	CRI	Drive Current <sup>1</sup> (mA)	Typical $V_f$ $T_c = 25^\circ\text{C}$ (V)	Typical Power $T_c = 25^\circ\text{C}$ (W)	Typical Flux <sup>2</sup> $T_c = 25^\circ\text{C}$ (lm)	Typical DC Flux <sup>3</sup> $T_c = 85^\circ\text{C}$ (lm)	Typical Efficacy $T_c = 25^\circ\text{C}$ (lm/W)
BXRC-35E1000-C-7X	80	180	33.2	6.0	1063	949	178
		240	34.0	8.2	1393	1238	171
		360	34.8	12.5	2000	1800	160
		540	35.6	19.2	2912	2530	151
		720	36.1	26.0	3720	3185	143
BXRC-35E1000-D-7X	80	175	24.9	4.4	776	705	178
		233	25.4	5.9	1018	915	172
		350	26.0	9.1	1453	1308	160
		525	27.4	14.4	2138	1844	149
		700	28.4	19.9	2740	2307	138
BXRC-35G1000-B-7X	90	135	33.2	4.5	665	598	148
		180	34.0	6.1	872	782	143
		270	34.8	9.4	1248	1124	133
		405	35.6	14.4	1832	1629	127
		540	36.1	19.5	2346	2077	120
BXRC-35G1000-C-7X	90	180	33.2	6.0	885	790	148
		240	34.0	8.2	1159	1030	142
		360	34.8	12.5	1665	1498	133
		540	35.6	19.2	2424	2106	126
		720	36.1	26.0	3096	2650	119
BXRC-35G1000-D-7X	90	175	24.9	4.4	646	587	148
		233	25.4	5.9	847	761	143
		350	26.0	9.1	1209	1088	133
		525	27.4	14.4	1780	1535	124
		700	28.4	19.9	2280	1920	115
BXRC-35A1001-B-73	93	135	33.2	4.5	626	562	140
		180	34.0	6.1	821	736	134
		270	34.8	9.4	1175	1057	125
		405	35.6	14.4	1723	1533	119
		540	36.1	19.5	2207	1954	113
BXRC-35A1001-C-73	93	180	33.2	6.0	833	743	139
		240	34.0	8.2	1091	969	134
		360	34.8	12.5	1566	1409	125
		540	35.6	19.2	2280	1981	118
		720	36.1	26.0	2913	2493	112
BXRC-35A1001-D-73	93	175	24.9	4.4	607	552	139
		233	25.4	5.9	797	716	135
		350	26.0	9.1	1138	1024	125
		525	27.4	14.4	1674	1444	117
		700	28.4	19.9	2145	1806	108
BXRC-40C1001-B-74	70	135	33.2	4.5	871	783	194
		180	34.0	6.1	1142	1025	187
		270	34.8	9.4	1635	1471	174
		405	35.6	14.4	2399	2134	166
		540	36.1	19.5	3073	2720	157

Notes for Table 4:

1. Alternate drive currents are provided for reference only and are not a guarantee of performance.
2. Bridgelux maintains a  $\pm 7\%$  tolerance on flux measurements.
3. Typical stabilized DC performance values are provided as reference only and are not a guarantee of performance.



# Performance at Commonly Used Drive Currents

Table 4: Product Performance at Commonly Used Drive Currents (Continued)

Part Number	CRI	Drive Current <sup>1</sup> (mA)	Typical $V_f$ $T_c = 25^\circ\text{C}$ (V)	Typical Power $T_c = 25^\circ\text{C}$ (W)	Typical Flux <sup>2</sup> $T_c = 25^\circ\text{C}$ (lm)	Typical DC Flux <sup>3</sup> $T_c = 85^\circ\text{C}$ (lm)	Typical Efficacy $T_c = 25^\circ\text{C}$ (lm/W)
BXRC-40C1001-C-74	70	180	33.2	6.0	1159	1034	194
		240	34.0	8.2	1518	1349	186
		360	34.8	12.5	2180	1962	174
		540	35.6	19.2	3174	2757	165
		720	36.1	26.0	4055	3471	156
BXRC-40C1001-D-74	70	175	24.9	4.4	845	769	194
		233	25.4	5.9	1109	997	187
		350	26.0	9.1	1583	1425	174
		525	27.4	14.4	2331	2010	162
		700	28.4	19.9	2986	2514	150
BXRC-40E1000-B-7X	80	135	33.2	4.5	805	723	179
		180	34.0	6.1	1055	946	172
		270	34.8	9.4	1510	1359	161
		405	35.6	14.4	2215	1970	153
		540	36.1	19.5	2838	2511	145
BXRC-40E1000-C-7X	80	180	33.2	6.0	1070	955	179
		240	34.0	8.2	1402	1246	172
		360	34.8	12.5	2013	1812	161
		540	35.6	19.2	2931	2546	152
		720	36.1	26.0	3744	3205	144
BXRC-40E1000-D-7X	80	175	24.9	4.4	781	710	179
		233	25.4	5.9	1024	921	173
		350	26.0	9.1	1462	1316	161
		525	27.4	14.4	2152	1856	150
		700	28.4	19.9	2757	2322	139
BXRC-40G1000-B-7X	90	135	33.2	4.5	691	621	154
		180	34.0	6.1	906	813	148
		270	34.8	9.4	1297	1167	138
		405	35.6	14.4	1903	1692	132
		540	36.1	19.5	2437	2157	125
BXRC-40G1000-C-7X	90	180	33.2	6.0	919	820	154
		240	34.0	8.2	1204	1070	148
		360	34.8	12.5	1729	1556	138
		540	35.6	19.2	2518	2187	131
		720	36.1	26.0	3216	2753	124
BXRC-40G1000-D-7X	90	175	24.9	4.4	671	610	154
		233	25.4	5.9	880	791	149
		350	26.0	9.1	1256	1130	138
		525	27.4	14.4	1849	1594	129
		700	28.4	19.9	2369	1994	119
BXRC-40H1000-B-7X	97	135	33.2	4.5	591	531	132
		180	34.0	6.1	775	695	127
		270	34.8	9.4	1109	998	118
		405	35.6	14.4	1627	1447	113
		540	36.1	19.5	2084	1844	107

Notes for Table 4:

1. Alternate drive currents are provided for reference only and are not a guarantee of performance.
2. Bridgelux maintains a  $\pm 7\%$  tolerance on flux measurements.
3. Typical stabilized DC performance values are provided as reference only and are not a guarantee of performance.

# Performance at Commonly Used Drive Currents

Table 4: Product Performance at Commonly Used Drive Currents (Continued)

Part Number	CRI	Drive Current <sup>1</sup> (mA)	Typical $V_f$ $T_c = 25^\circ\text{C}$ (V)	Typical Power $T_c = 25^\circ\text{C}$ (W)	Typical Flux <sup>2</sup> $T_c = 25^\circ\text{C}$ (lm)	Typical DC Flux <sup>3</sup> $T_c = 85^\circ\text{C}$ (lm)	Typical Efficacy $T_c = 25^\circ\text{C}$ (lm/W)
BXRC-40H1000-C-7X	97	180	33.2	6.0	786	701	131
		240	34.0	8.2	1030	915	126
		360	34.8	12.5	1478	1330	118
		540	35.6	19.2	2153	1870	112
		720	36.1	26.0	2750	2354	106
BXRC-40H1000-D-7X	97	175	24.9	4.4	573	521	131
		233	25.4	5.9	752	676	127
		350	26.0	9.1	1074	966	118
		525	27.4	14.4	1581	1363	110
		700	28.4	19.9	2025	1705	102
BXRC-40A1001-B-73	93	135	33.2	4.5	666	598	149
		180	34.0	6.1	873	783	143
		270	34.8	9.4	1250	1125	133
		405	35.6	14.4	1833	1631	127
		540	36.1	19.5	2349	2079	120
BXRC-40A1001-C-73	93	180	33.2	6.0	886	790	148
		240	34.0	8.2	1161	1031	142
		360	34.8	12.5	1666	1500	133
		540	35.6	19.2	2426	2108	126
		720	36.1	26.0	3099	2653	119
BXRC-40A1001-D-73	93	175	24.9	4.4	646	588	148
		233	25.4	5.9	848	762	143
		350	26.0	9.1	1210	1089	133
		525	27.4	14.4	1781	1536	124
		700	28.4	19.9	2282	1922	115
BXRC-50C1001-B-74	70	135	33.2	4.5	882	792	197
		180	34.0	6.1	1156	1037	189
		270	34.8	9.4	1655	1489	176
		405	35.6	14.4	2428	2160	168
		540	36.1	19.5	3110	2753	159
BXRC-50C1001-C-74	70	180	33.2	6.0	1173	1047	196
		240	34.0	8.2	1537	1365	188
		360	34.8	12.5	2207	1986	176
		540	35.6	19.2	3213	2791	167
		720	36.1	26.0	4104	3513	158
BXRC-50C1001-D-74	70	175	24.9	4.4	856	778	196
		233	25.4	5.9	1123	1009	190
		350	26.0	9.1	1603	1443	176
		525	27.4	14.4	2359	2035	164
		700	28.4	19.9	3023	2545	152
BXRC-50E1001-B-74	80	135	33.2	4.5	830	746	185
		180	34.0	6.1	1089	976	178
		270	34.8	9.4	1558	1402	166
		405	35.6	14.4	2286	2033	158
		540	36.1	19.5	2929	2592	150

Notes for Table 4:

1. Alternate drive currents are provided for reference only and are not a guarantee of performance.
2. Bridgelux maintains a  $\pm 7\%$  tolerance on flux measurements.
3. Typical stabilized DC performance values are provided as reference only and are not a guarantee of performance.

# Performance at Commonly Used Drive Currents

Table 4: Product Performance at Commonly Used Drive Currents (Continued)

Part Number	CRI	Drive Current <sup>1</sup> (mA)	Typical $V_f$ $T_c = 25^\circ\text{C}$ (V)	Typical Power $T_c = 25^\circ\text{C}$ (W)	Typical Flux <sup>2</sup> $T_c = 25^\circ\text{C}$ (lm)	Typical DC Flux <sup>3</sup> $T_c = 85^\circ\text{C}$ (lm)	Typical Efficacy $T_c = 25^\circ\text{C}$ (lm/W)
BXRC-50E1001-C-74	80	180	33.2	6.0	1105	986	185
		240	34.0	8.2	1447	1286	177
		360	34.8	12.5	2078	1870	166
		540	35.6	19.2	3025	2628	157
		720	36.1	26.0	3864	3308	148
BXRC-50E1001-D-74	80	175	24.9	4.4	806	733	185
		233	25.4	5.9	1057	950	179
		350	26.0	9.1	1509	1358	166
		525	27.4	14.4	2221	1916	155
		700	28.4	19.9	2846	2396	143
BXRC-50G1001-B-74	90	135	33.2	4.5	701	630	156
		180	34.0	6.1	920	825	150
		270	34.8	9.4	1316	1185	140
		405	35.6	14.4	1931	1718	134
		540	36.1	19.5	2474	2189	127
BXRC-50G1001-C-74	90	180	33.2	6.0	933	833	156
		240	34.0	8.2	1222	1086	150
		360	34.8	12.5	1755	1579	140
		540	35.6	19.2	2555	2220	133
		720	36.1	26.0	3264	2794	125
BXRC-50G1001-D-74	90	175	24.9	4.4	681	619	156
		233	25.4	5.9	893	803	151
		350	26.0	9.1	1275	1147	140
		525	27.4	14.4	1876	1618	131
		700	28.4	19.9	2404	2024	121
BXRC-57C1001-B-74	70	135	33.2	4.5	851	765	190
		180	34.0	6.1	1116	1001	182
		270	34.8	9.4	1597	1437	170
		405	35.6	14.4	2343	2084	162
		540	36.1	19.5	3001	2656	154
BXRC-57C1001-C-74	70	180	33.2	6.0	1132	1010	189
		240	34.0	8.2	1483	1317	182
		360	34.8	12.5	2129	1916	170
		540	35.6	19.2	3100	2693	161
		720	36.1	26.0	3960	3390	152
BXRC-57C1001-D-74	70	175	24.9	4.4	826	751	189
		233	25.4	5.9	1083	974	183
		350	26.0	9.1	1547	1392	170
		525	27.4	14.4	2276	1963	158
		700	28.4	19.9	2916	2456	147
BXRC-57E1001-B-74	80	135	33.2	4.5	821	738	183
		180	34.0	6.1	1077	966	176
		270	34.8	9.4	1541	1387	164
		405	35.6	14.4	2261	2011	157
		540	36.1	19.5	2896	2563	148

Notes for Table 4:

1. Alternate drive currents are provided for reference only and are not a guarantee of performance.
2. Bridgelux maintains a  $\pm 7\%$  tolerance on flux measurements.
3. Typical stabilized DC performance values are provided as reference only and are not a guarantee of performance.

# Performance at Commonly Used Drive Currents

Table 4: Product Performance at Commonly Used Drive Currents (Continued)

Part Number	CRI	Drive Current <sup>1</sup> (mA)	Typical V <sub>f</sub> T <sub>c</sub> = 25°C (V)	Typical Power T <sub>c</sub> = 25°C (W)	Typical Flux <sup>2</sup> T <sub>c</sub> = 25°C (lm)	Typical DC Flux <sup>3</sup> T <sub>c</sub> = 85°C (lm)	Typical Efficacy T <sub>c</sub> = 25°C (lm/W)
BXRC-57E1001-D-74	80	175	24.9	4.4	797	725	183
		233	25.4	5.9	1045	940	177
		350	26.0	9.1	1492	1343	164
		525	27.4	14.4	2197	1895	153
		700	28.4	19.9	2814	2370	141
BXRC-65C1001-B-74	70	135	33.2	4.5	866	779	193
		180	34.0	6.1	1136	1019	186
		270	34.8	9.4	1626	1463	173
		405	35.6	14.4	2385	2122	165
		540	36.1	19.5	3056	2705	157
BXRC-65C1001-C-74	70	180	33.2	6.0	1153	1028	193
		240	34.0	8.2	1510	1341	185
		360	34.8	12.5	2168	1951	173
		540	35.6	19.2	3157	2742	164
		720	36.1	26.0	4032	3452	155
BXRC-65C1001-D-74	70	175	24.9	4.4	841	764	193
		233	25.4	5.9	1103	992	186
		350	26.0	9.1	1575	1417	173
		525	27.4	14.4	2318	1999	161
		700	28.4	19.9	2970	2501	149
BXRC-65E1001-B-74	80	135	33.2	4.5	836	751	186
		180	34.0	6.1	1096	983	179
		270	34.8	9.4	1569	1412	167
		405	35.6	14.4	2302	2048	160
		540	36.1	19.5	2949	2610	151
BXRC-65E1001-C-74	80	180	33.2	6.0	1112	993	186
		240	34.0	8.2	1457	1295	179
		360	34.8	12.5	2092	1883	167
		540	35.6	19.2	3047	2647	158
		720	36.1	26.0	3892	3331	150
BXRC-65E1001-D-74	80	175	24.9	4.4	811	738	186
		233	25.4	5.9	1064	957	180
		350	26.0	9.1	1520	1368	167
		525	27.4	14.4	2237	1929	156
		700	28.4	19.9	2866	2413	144

Notes for Table 4:

1. Alternate drive currents are provided for reference only and are not a guarantee of performance.
2. Bridgelux maintains a ± 7% tolerance on flux measurements.
3. Typical stabilized DC performance values are provided as reference only and are not a guarantee of performance.

# Electrical Characteristics

Table 5: Electrical Characteristics

Part Number	Drive Current (mA)	Forward Voltage Pulsed, $T_c = 25^\circ\text{C}$ (V) <sup>1, 2, 3, 8</sup>			Typical Coefficient of Forward Voltage <sup>4</sup> $\Delta V_f / \Delta T_c$ (mV/ $^\circ\text{C}$ )	Typical Thermal Resistance Junction to Case <sup>5,6</sup> $R_{j,c}$ ( $^\circ\text{C}/\text{W}$ )	Driver Selection Voltages <sup>7</sup> (V)	
		Minimum	Typical	Maximum			$V_f$ Min. Hot $T_c = 105^\circ\text{C}$ (V)	$V_f$ Max. Cold $T_c = -40^\circ\text{C}$ (V)
BXRC-xxx100x-B-7x	270	32.2	34.8	37.4	-16.1	0.49	30.9	38.5
	540	33.4	36.1	38.8	-16.1	0.56	32.1	39.9
BXRC-xxx100x-C-7x	360	32.2	34.8	37.4	-16.1	0.37	30.9	38.5
	720	33.4	36.1	38.8	-16.1	0.45	32.1	39.9
BXRC-xxx100x-D-7x	350	24.1	26.0	28.0	-11.8	0.49	23.1	28.7
	700	26.3	28.4	30.5	-11.8	0.57	25.3	31.3

Notes for Table 5:

- Parts are tested in pulsed conditions,  $T_c = 25^\circ\text{C}$ . Pulse width is 10ms.
- Voltage minimum and maximum are provided for reference only and are not a guarantee of performance.
- Bridgelux maintains a tester tolerance of  $\pm 0.10\text{V}$  on forward voltage measurements.
- Typical coefficient of forward voltage tolerance is  $\pm 0.1\text{mV}$  for nominal current.
- Thermal resistance values are based from test data of a 3000K 80 CRI product.
- Thermal resistance value was calculated using total electrical input power; optical power was not subtracted from input power. The thermal interface material used during testing is not included in the thermal resistance value.
- $V_f$  min hot and max cold values are provided as reference only and are not guaranteed by test. These values are provided to aid in driver design and selection over the operating range of the product.
- This product has been designed and manufactured per IEC 62031:2014. This product has passed dielectric withstand voltage testing at 1160V. The working voltage designated for the insulation is 80V d.c. The maximum allowable voltage across the array must be determined in the end product application.

# Eye Safety

Table 6: Eye Safety Risk Group (RG) Classifications

Part Number	Drive Current <sup>5</sup> (mA)	CCT <sup>1,5</sup>			
		2700K/3000K	4000K <sup>2</sup>	5000K <sup>3</sup>	6500K <sup>4</sup>
BXRC-xxx100x-B-7x	270	RG1	RG1	RG1	RG1
	405	RG1	RG1	RG1	RG2
	540	RG1	RG1	RG2	RG2
BXRC-xxx100x-C-7x	360	RG1	RG1	RG1	RG2
	540	RG1	RG1	RG2	RG2
	720	RG1	RG2	RG2	RG2
BXRC-xxx100x-D-7x	350	RG1	RG1	RG1	RG1
	525	RG1	RG1	RG1	RG2
	700	RG1	RG1	RG2	RG2

Notes for Table 6:

1. Eye safety classification for the use of Bridgelux Vero Series LED arrays is in accordance with specification IEC/TR 62778: Application of IEC 62471 for the assessment of blue light hazard to light sources and luminaires.
2. For products classified as RG2 at 4000K,  $E_{thr} = 1847.5$  lx.
3. For products classified as RG2 at 5000K  $E_{thr} = 1315.8$  lx.
4. For products classified as RG2 at 6500K,  $E_{thr} = 1124.5$  lx.
5. Please contact your Bridgelux sales representative for  $E_{thr}$  values at specific drive currents and CCTs not listed.

# Absolute Maximum Ratings

Table 7: Maximum Ratings

Parameter	Maximum Rating		
LED Junction Temperature (T <sub>j</sub> )	125°C		
Storage Temperature	-40°C to +105°C		
Operating Case Temperature <sup>1</sup> (T <sub>c</sub> )	105°C		
Soldering Temperature <sup>2</sup>	300°C or lower for a maximum of 6 seconds		
	BXRC-xxx100x-B-7x	BXRC-xxx100x-C-7x	BXRC-xxx100x-D-7x
Maximum Drive Current <sup>3</sup>	540mA	720mA	700mA
Maximum Peak Pulsed Drive Current <sup>4</sup>	770mA	1030mA	1000mA
Maximum Reverse Voltage <sup>5</sup>	-60V	-60V	-45V

Notes for Table 7:

1. For IEC 62717 requirement, please consult your Bridgelux sales representative.
2. Refer to Bridgelux Application Note AN31: Assembly Considerations for Bridgelux Vero LED Arrays.
3. Arrays may be driven at higher currents however lumen maintenance may be reduced.
4. Bridgelux recommends a maximum duty cycle of 10% and pulse width of 20 ms when operating LED Arrays at maximum peak pulsed current specified. Maximum peak pulsed currents indicate values where LED Arrays can be driven without catastrophic failures.
5. Light emitting diodes are not designed to be driven in reverse voltage and will not produce light under this condition. Maximum rating provided for reference only.

# Performance Curves

Figure 1: Vero 10B Drive Current vs. Voltage

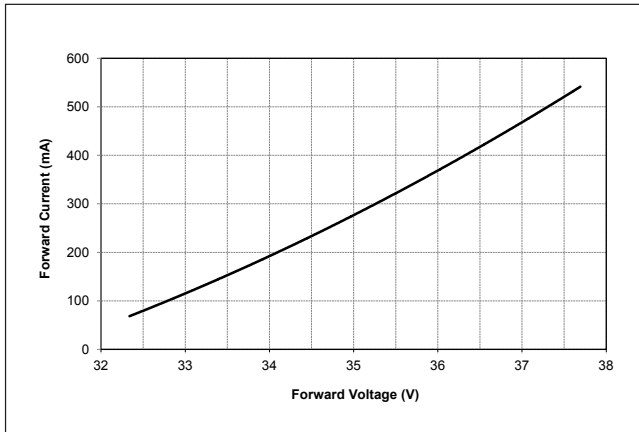

Figure 2: Vero 10C Drive Current vs. Voltage

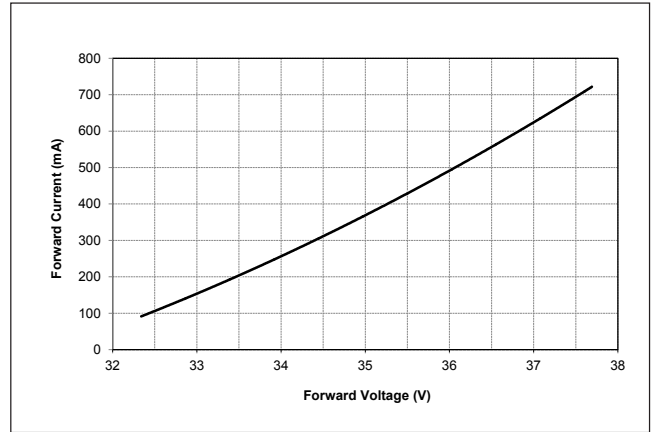

Figure 3: Vero 10D Drive Current vs. Voltage

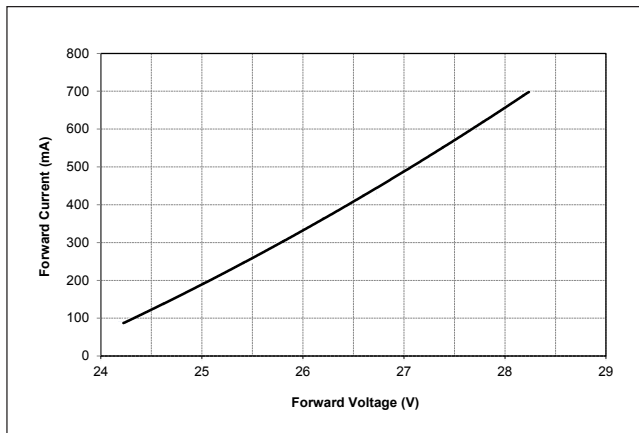

Figure 4: Vero 10B Typical Relative Flux vs. Current

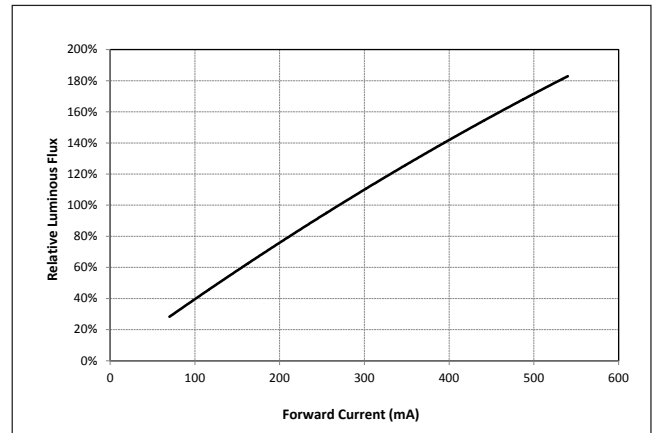

Figure 5: Vero 10C Typical Relative Flux vs. Current

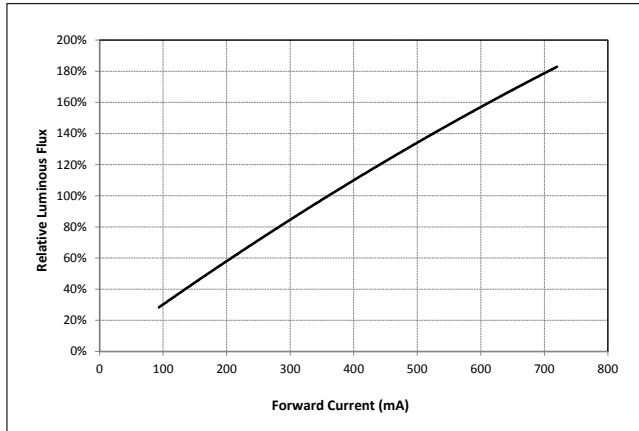
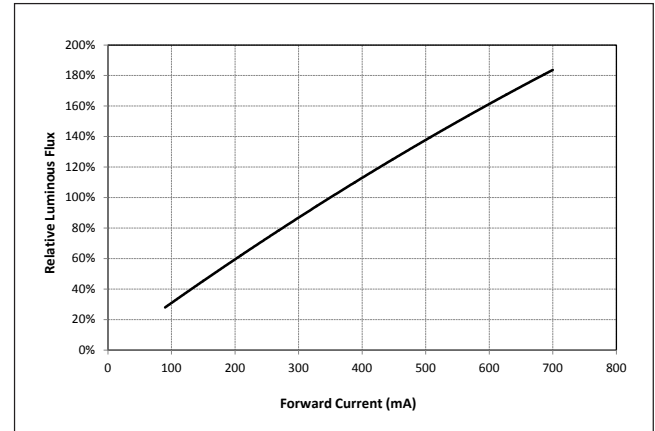

Figure 6: Vero 10D Typical Relative Flux vs. Current



Notes for Figure 1-6:

1. Bridgelux does not recommend driving high power LEDs at low currents. Doing so may produce unpredictable results. Pulse width modulation (PWM) is recommended for dimming effects.
2. Products tested under pulsed condition (10ms pulse width) at nominal test current where  $T_j$  (junction temperature) =  $T_c$  (case temperature) = 25°C.



# Performance Curves

Figure 7: Typical DC Flux vs. Case Temperature

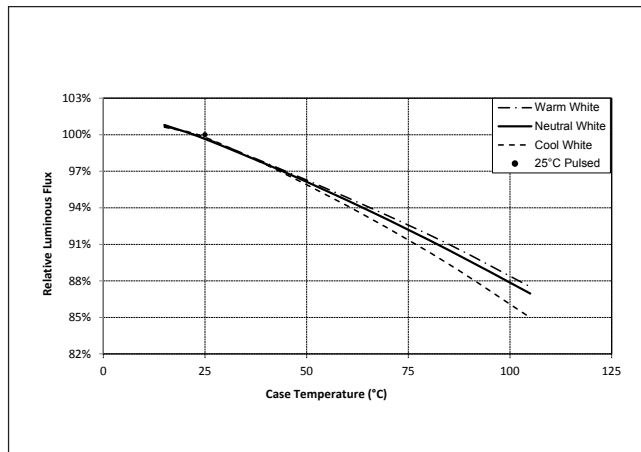

Figure 8: Typical DC ccy Shift vs. Case Temperature

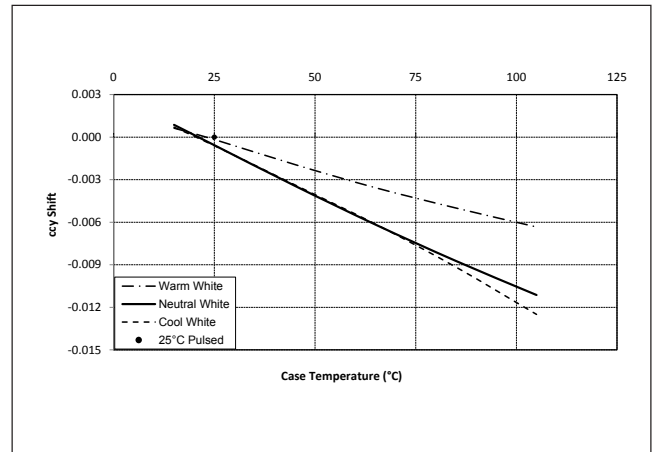

Figure 9: Typical DC ccx Shift vs. Case Temperature

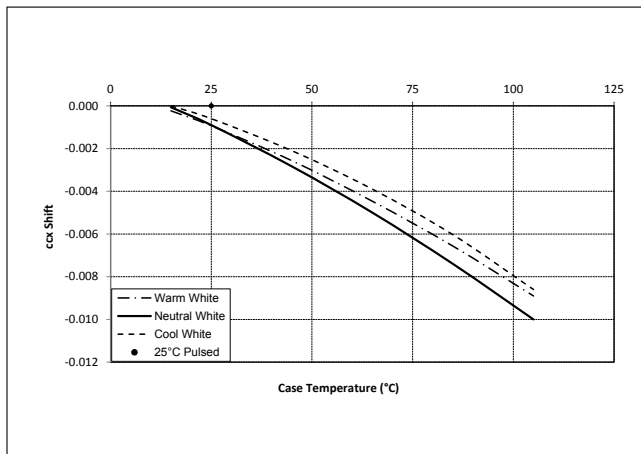
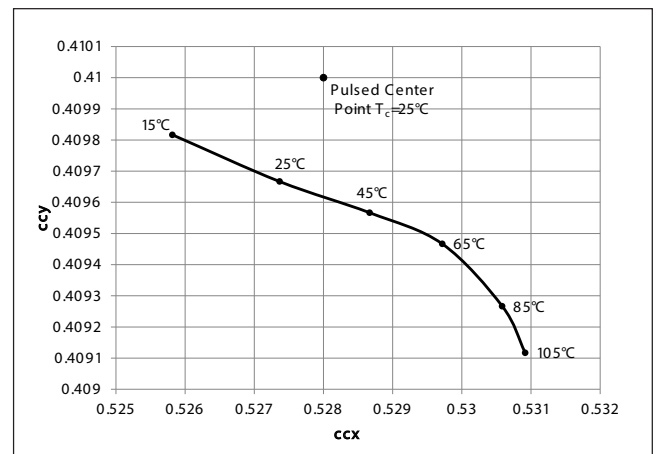

Figure 10: 2000K, 65 CRI Color Shift vs. Case Temperature



Notes for Figures 7 - 9:

1. Characteristics shown for warm white based on 3000K and 80 CRI.
2. Characteristics shown for neutral white based on 4000K and 80 CRI.
3. Characteristics shown for cool white based on 5000K and 70 CRI.
4. For other color SKUs, the shift in color will vary. Please contact your Bridgelux Sales Representative for more information.

# Performance Curves

Figure 11: 2700K, 97 CRI Color Shift vs. Case Temperature<sup>1</sup>

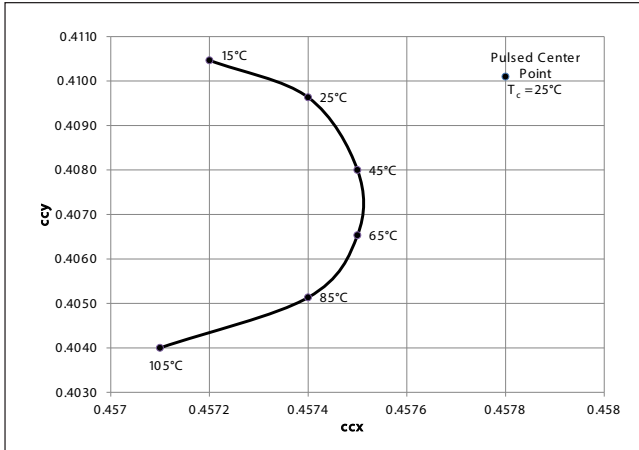

Figure 12: 3000K, 97 CRI Color Shift vs. Case Temperature<sup>1</sup>

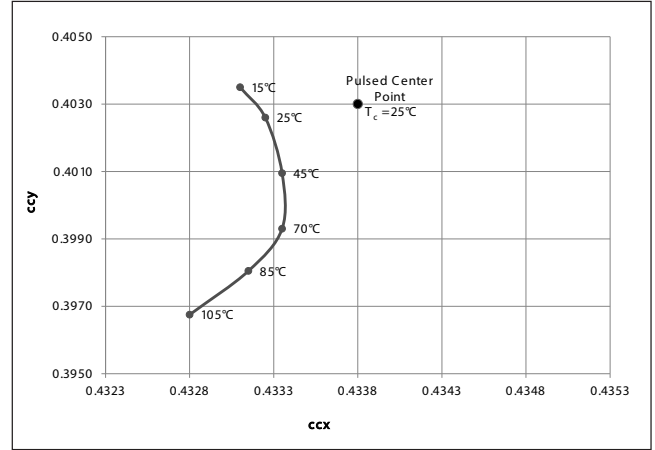

Figure 13: 3000K, 90 CRI Color Shift vs. Case Temperature<sup>3</sup>

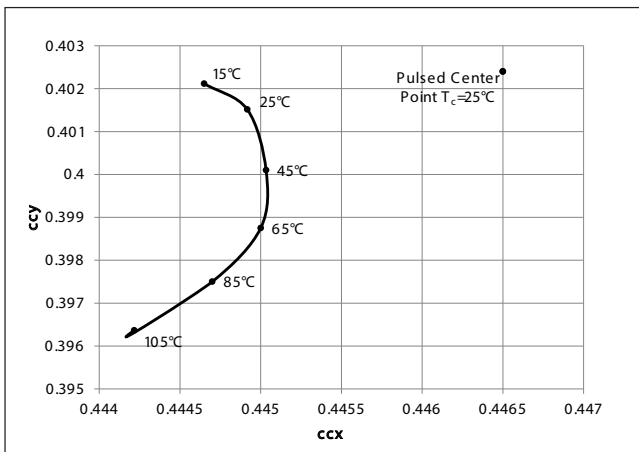

Figure 14: 3000K Class A Color Shift vs. Case Temperature<sup>1</sup>

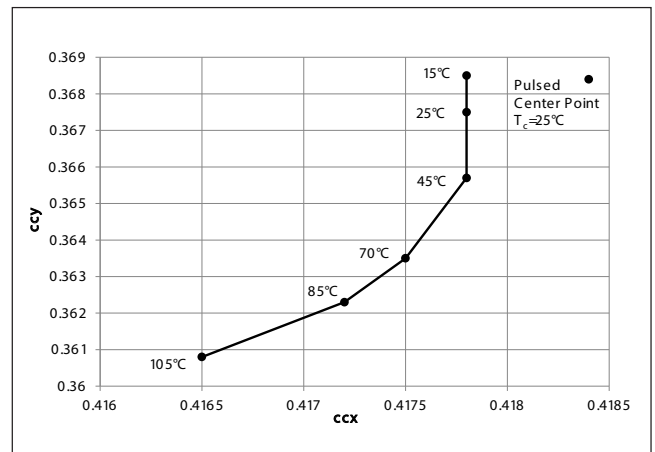

Figure 15: 3500K Class A Color Shift vs. Case Temperature<sup>1</sup>

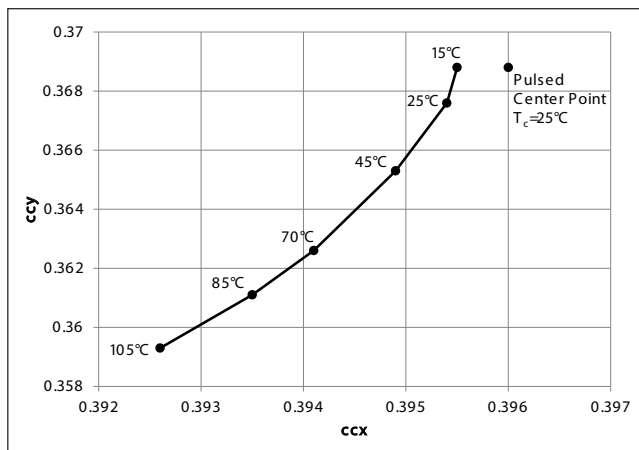
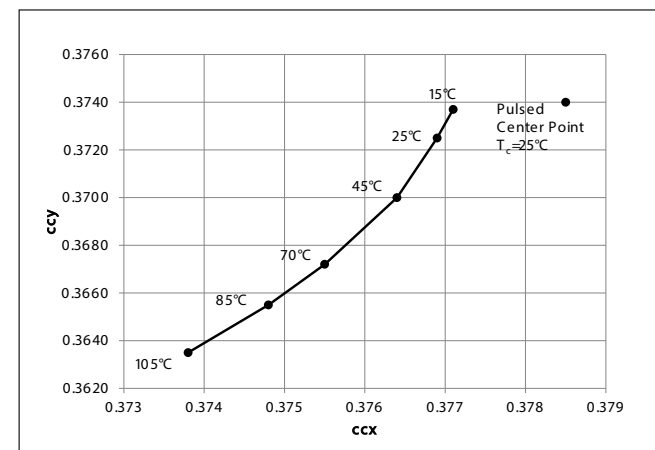

Figure 16: 4000K Class A Color Shift vs. Case Temperature<sup>1</sup>



Note for Figures 10-16:

1. Measurements made under DC test conditions at the nominal drive current.
2. Typical color shift is shown with a tolerance of  $\pm 0.002$ .
3. Characteristics shown for Decor Series Showcase products, BXRC-30G100C-x-73

# Typical Radiation Pattern

Figure 17: Typical Spatial Radiation Pattern

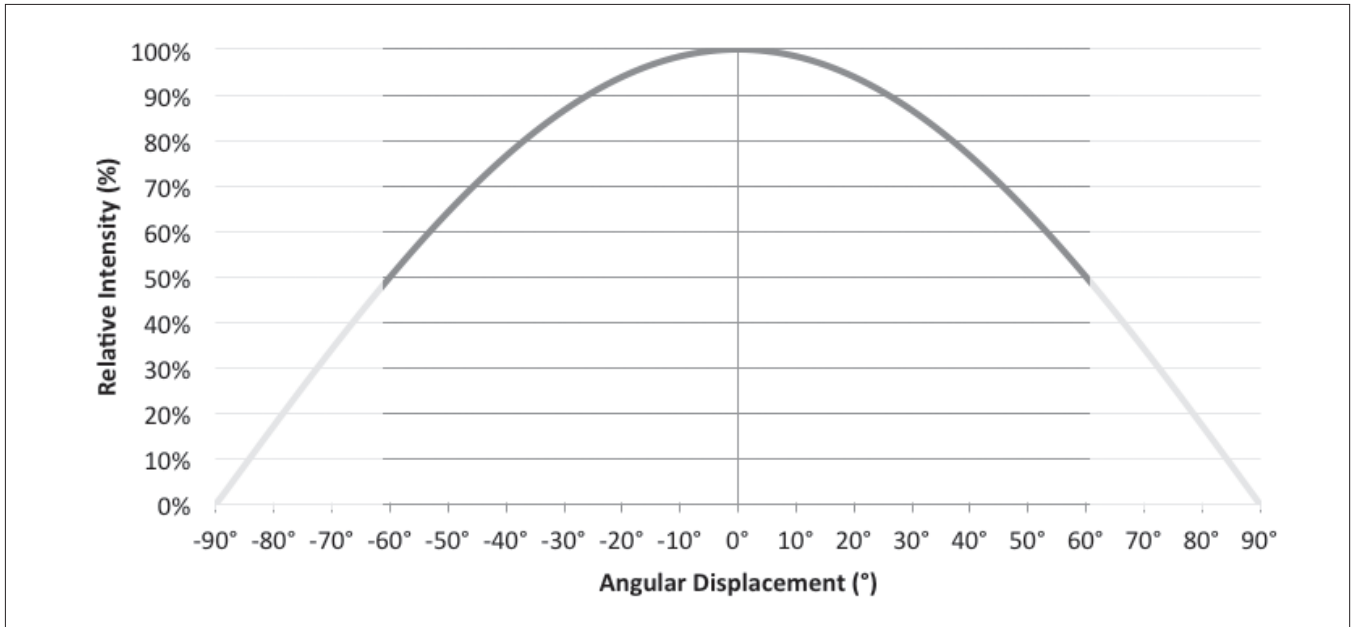

Note for Figure 17:

1. Typical viewing angle is 120°.
2. The viewing angle is defined as the off axis angle from the centerline where intensity is ½ of the peak value.

Figure 18: Typical Polar Radiation Pattern

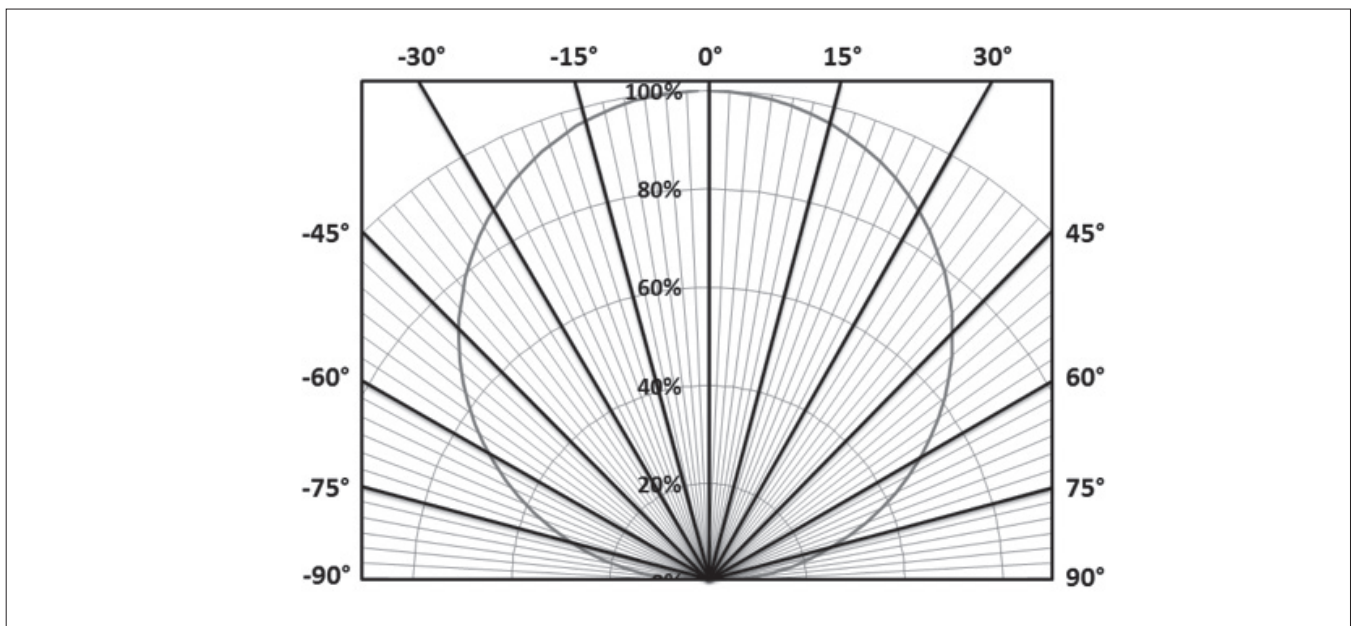

# Typical Color Spectrum

Figure 19: Typical Color Spectrum

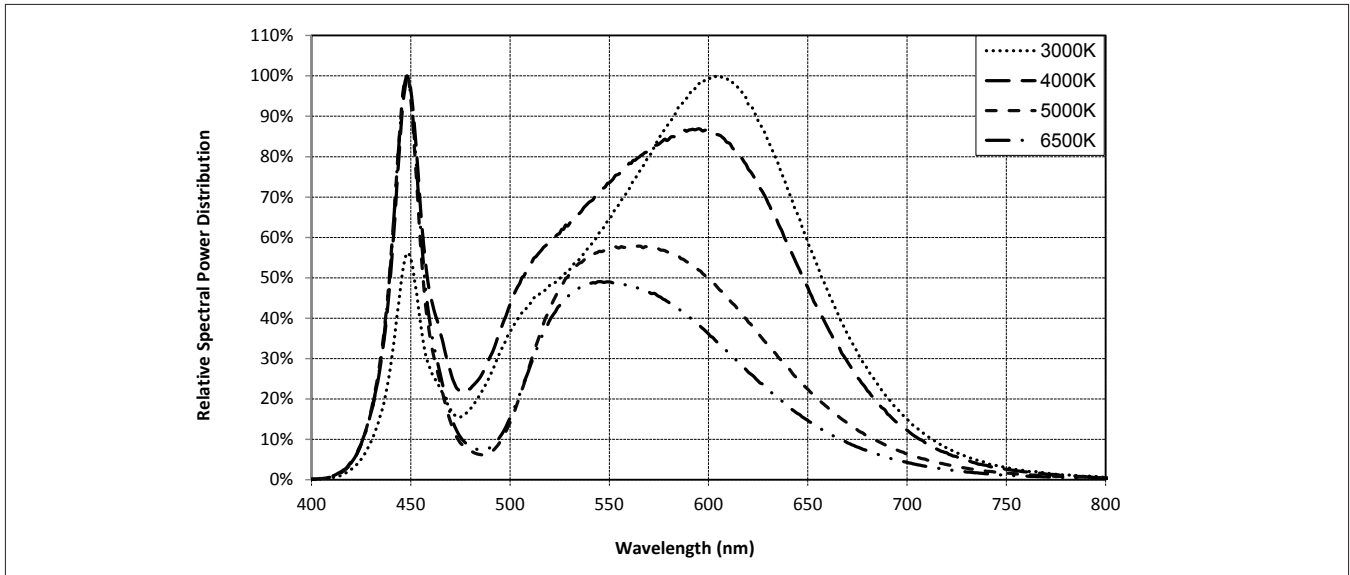

Note for Figure 19:

1. Color spectra measured at nominal current for  $T_j = T_c = 25^\circ\text{C}$ .
2. Color spectra shown is 3000K and 80 CRI.
3. Color spectra shown is 4000K and 80 CRI.
4. Color spectra shown is 5000K and 70 CRI.
4. Color spectra shown is 6500K and 70 CRI.

Figure 20: Typical Color Spectrum for Vero 10 with Décor Series

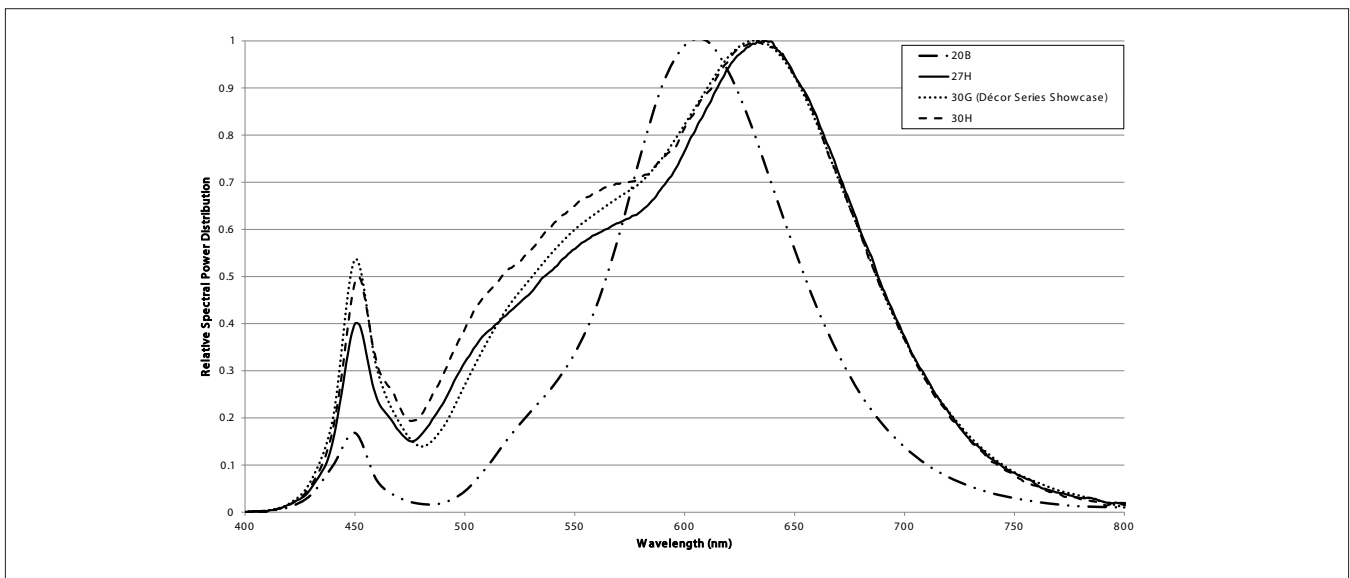

Note for Figure 20:

1. Color spectra measured at nominal current for  $T_j = T_c = 25^\circ\text{C}$ .

# Mechanical Dimensions

Figure 21: Drawing for Vero 10 LED Array

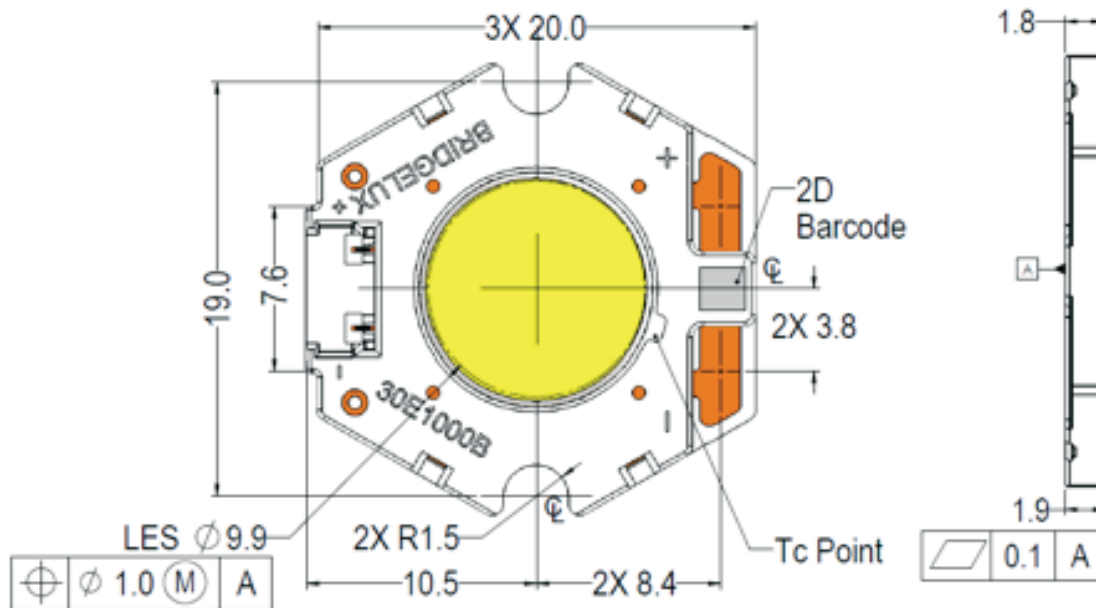

Notes for Figure 21:

1. Drawings are not to scale.
2. Dimensions are in mm.
3. Unless otherwise specified, tolerances are  $\pm 0.10\text{mm}$ .
4. Mounting slots (2X) are for M2.5 screws.
5. Bridgelux recommends two tapped holes for mounting screws with  $19.0 \pm 0.10\text{mm}$  center-to-center spacing.
6. Screws with flat shoulders (pan, dome, button, round, truss, mushroom) provide optimal torque control. Do NOT use flat, countersink, or raised head screws.
7. Solder pads and connector port are labeled "+" and "-" to denote positive and negative, respectively.
8. It is not necessary to provide electrical connections to both the solder pads and the connector port. Either set may be used depending on application specific design requirements.
9. Refer to Application Notes AN30 and AN31 for product handling, mounting and heat sink recommendations.
10. The optical center of the LED Array is nominally defined by the mechanical center of the array to a tolerance of  $\pm 0.2\text{mm}$ .
11. Bridgelux maintains a flatness of 0.10mm across the mounting surface of the array.

# Color Binning Information

Figure 22: Warm and Neutral White Test Bins in xy Color Space

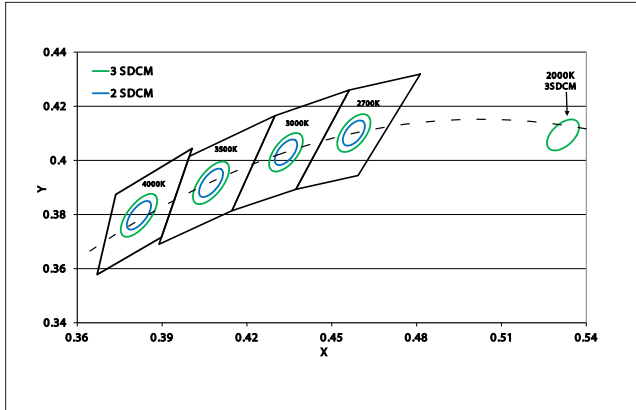

Note: Pulsed Test Conditions,  $T_c = 25^\circ\text{C}$

Figure 23: Graph of Cool White Test Bins in xy Color Space

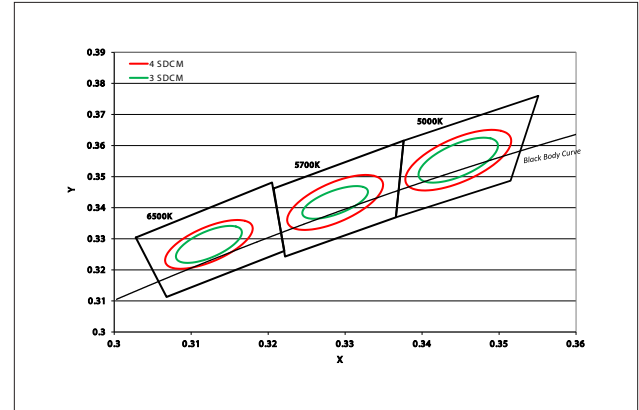

Note: Pulsed Test Conditions,  $T_c = 25^\circ\text{C}$

Table 8: Warm and Neutral White xy Bin Coordinates and Associated Typical CCT

Bin Code	2000K	2700K	3000K <sup>1</sup>	3500K <sup>1</sup>	4000K <sup>1</sup>
ANSI Bin (for reference only)	-	(2580K - 2870K)	(2870K - 3220K)	(3220K - 3710K)	(3710K - 4260K)
73 (3 SDCM)	-	(2651K - 2794K)	(2968K - 3136K)	(3369K - 3586K)	(3851K - 4130K)
72 (2 SDCM)	-	(2674K - 2769K)	(2995K - 3107K)	(3404K - 3548K)	(3895K - 4081K)
Center Point (x,y)	(0.5280, 0.4100)	(0.4578, 0.4101)	(0.4338, 0.403) (0.4465, 0.4024) <sup>2</sup>	(0.4073, 0.3917)	(0.3818, 0.3797)

Note for Table 8:

1. Color Binning information excludes Decor Series Class A products. Please contact your Bridgelux Sales Representative for more information.
2. Center Point for Decor Series Showcase.

Table 9: Cool White xy Bin Coordinates and Associated Typical CCT (product is hot targeted to  $T_c = 85^\circ\text{C}$ )

Bin Code	5000K	5700K	6500K
ANSI Bin (for reference only)	(4745K - 5311K)	(5312K - 6022K)	(6022K - 7042K)
74 (4 SDCM)	(4801K - 5282K)	(5481K - 5829K)	(6270K - 6765K)
73 (3 SDCM)	(4835K-5215K)	(5490K-5820K)	(6250K-6745K)
Center Point (x,y)	(0.3447, 0.3553)	(0.3287, 0.3417)	(0.3123, 0.3282)

# Packaging and Labeling

Figure 24: Drawing for Vero 10 Packaging Tray

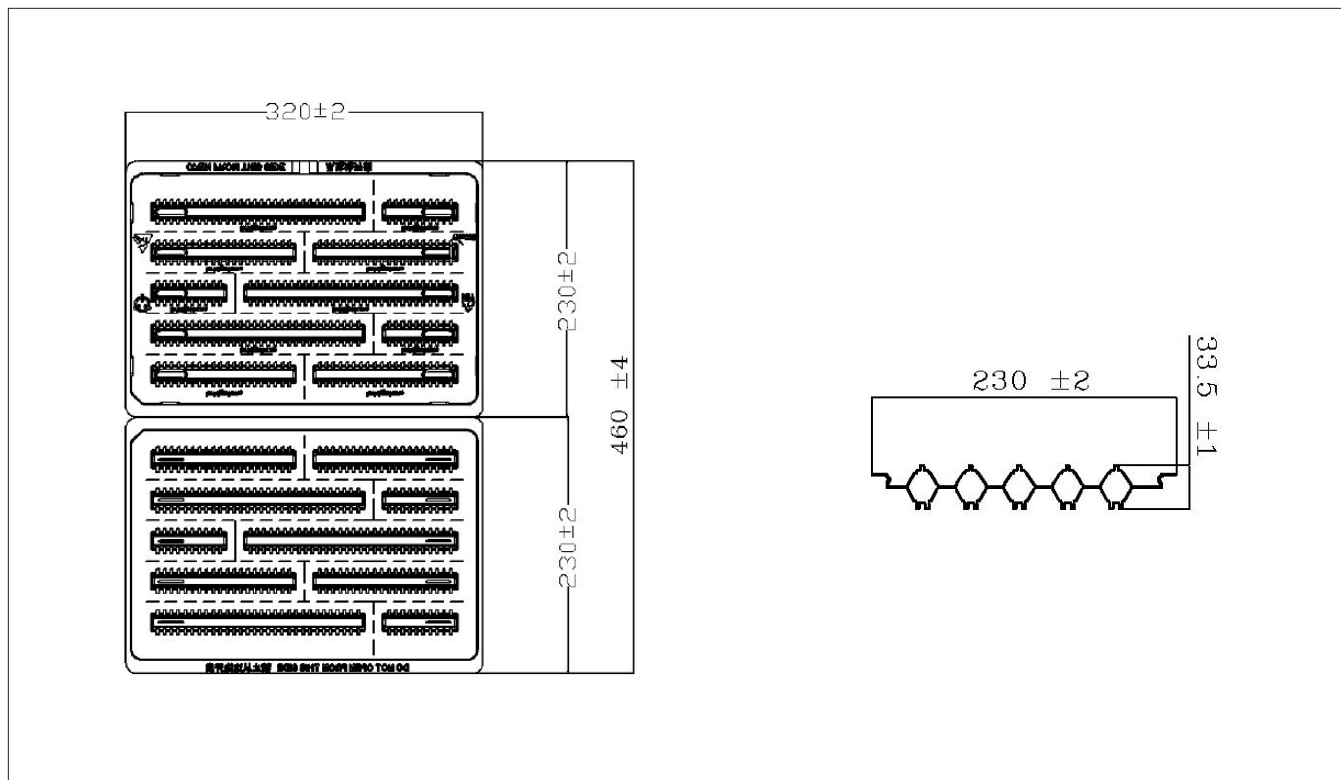

Notes for Figure 24:

1. Dimensions are in millimeters.
2. Drawings are not to scale.

# Packaging and Labeling

Figure 25: Vero Series Packaging and Labeling

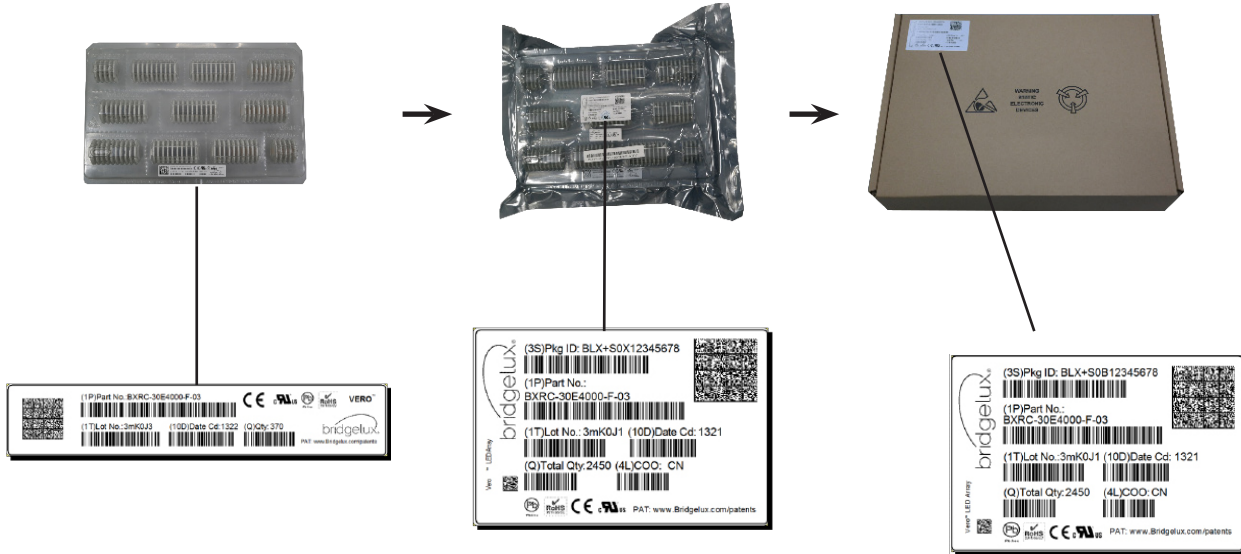

Notes for Figure 25:

1. Each tray holds 200 COBs.
2. Each tray is vacuum sealed in an anti-static bag and placed in its own box.
3. Each tray, bag and box is to be labeled as shown above.

Figure 26: Gen. 7 Product Labeling

Bridgelux COB arrays have laser markings on the back side of the substrate to help with product identification. In addition to the product identification markings, Bridgelux COB arrays also contain markings for internal Bridgelux manufacturing use only. The image below shows which markings are for customer use and which ones are for Bridgelux internal use only. The Bridgelux internal manufacturing markings are subject to change without notice, however these will not impact the form, function or performance of the COB array.





# Design Resources

## Application Notes

Bridgelux has developed a comprehensive set of application notes and design resources to assist customers in successfully designing with the Vero product family of LED array products. For all available application notes visit [www.bridgelux.com](http://www.bridgelux.com).

## Optical Source Models

Optical source models and ray set files are available for all Bridgelux products. For a list of available formats, visit [www.bridgelux.com](http://www.bridgelux.com).

## 3D CAD Models

Three dimensional CAD models depicting the product outline of all Bridgelux Vero LED arrays are available in both IGS and STEP formats. Please contact your Bridgelux sales representative for assistance.

## LM80

LM80 testing has been completed and the LM80 report is now available. Please contact your Bridgelux sales representative for LM-80 report.

# Precautions

## CAUTION: CHEMICAL EXPOSURE HAZARD

Exposure to some chemicals commonly used in luminaire manufacturing and assembly can cause damage to the LED array. Please consult Bridgelux Application Note AN31 for additional information.

## CAUTION: RISK OF BURN

Do not touch the Vero LED array during operation. Allow the array to cool for a sufficient period of time before handling. The Vero LED array may reach elevated temperatures such that could burn skin when touched.

## CAUTION

### CONTACT WITH LIGHT EMITTING SURFACE (LES)

Avoid any contact with the LES. Do not touch the LES of the LED array or apply stress to the LES (yellow phosphor resin area). Contact may cause damage to the LED array.

Optics and reflectors must not be mounted in contact with the LES (yellow phosphor resin area). Optical devices may be mounted on the top surface of the plastic housing of the Vero LED array. Use the mechanical features of the LED array housing, edges and/or mounting holes to locate and secure optical devices as needed.

# Disclaimers

## MINOR PRODUCT CHANGE POLICY

The rigorous qualification testing on products offered by Bridgelux provides performance assurance. Slight cosmetic changes that do not affect form, fit, or function may occur as Bridgelux continues product optimization.

## STANDARD TEST CONDITIONS

Unless otherwise stated, array testing is performed at the nominal drive current.

# About Bridgelux: Bridging Light and Life™

At Bridgelux, we help companies, industries and people experience the power and possibility of light. Since 2002, we've designed LED solutions that are high performing, energy efficient, cost effective and easy to integrate. Our focus is on light's impact on human behavior, delivering products that create better environments, experiences and returns—both experiential and financial. And our patented technology drives new platforms for commercial and industrial luminaires.

For more information about the company, please visit  
[bridgelux.com](http://bridgelux.com)  
[twitter.com/Bridgelux](https://twitter.com/Bridgelux)  
[facebook.com/Bridgelux](https://facebook.com/Bridgelux)  
[youtube.com/user/Bridgelux](https://youtube.com/user/Bridgelux)  
[linkedin.com/company/bridgelux-inc-\\_2](https://linkedin.com/company/bridgelux-inc-_2)  
WeChat ID: BridgeluxInChina



46430 Fremont Boulevard  
Fremont, CA 94538 U.S.A.  
Tel (925) 583-8400  
[www.bridgelux.com](http://www.bridgelux.com)

© 2016-2018 Bridgelux, Inc. All rights reserved 2018. Product specifications are subject to change without notice. Bridgelux, the Bridgelux stylized logo design, Vero, V Series and V Series HD are registered trademarks, and Decor Series is a trademark of Bridgelux, Inc. All other trademarks are the property of their respective owners.

Bridgelux Gen 7 Vero 10 Array Series Product Data Sheet DS90 Rev. M (09/2018)