

**NOTE:**  
CONTACT IDENTIFICATION POSITIONS SHOWN ARE  
WIRING FACE OF STANDARD PLUG AND MATING FACE  
OF STANDARD RECEPTACLE. REVERSED SERIES  
HOUSINGS HAVE MIRROR IMAGE IDENTIFICATION.

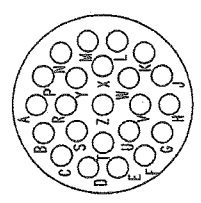

4 WAY.

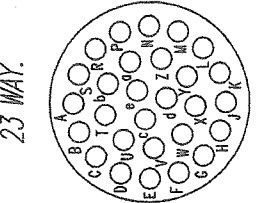

8 WAY.

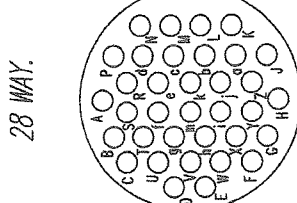

12 WAY.

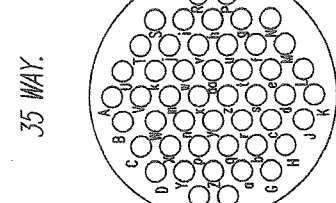

19 WAY.

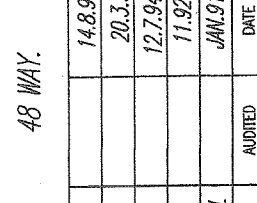

23 WAY.

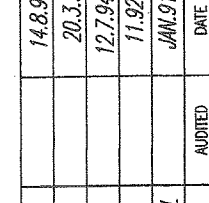

28 WAY.

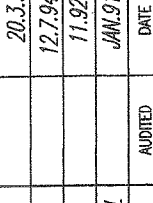

35 WAY.

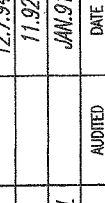

48 WAY.

CHARACTERISTICS.	PERFORMANCE.
FLAMMABILITY.	UL94V-0
* OPERATING VOLTAGE.	REGULAR 250.V. ac rms. 7-WAY VDEU 380.V. ac rms.
CONTACT CURRENT RATING.	UP TO 13 AMPERES. (SEE CONTACTS SECTION).
OPERATING TEMPERATURE.	-55° C TO +125° C
INSULATION RES.	5000 M Ω MIN. AT 500V. dc.
MOULDING SEPARATION FORCE.	150 NEWTONS MINIMUM WITH COUPLING ENGAGED FOR UNLOADED CONNECTOR.
	125V
TEST VOLTAGE.	1550V ac FOR 60 SECS.
	380V

\* VOLTAGE RATING VARIES WITH CONTACTS USED AND DEGREE OF POLLUTION. CONSULT FACTORY

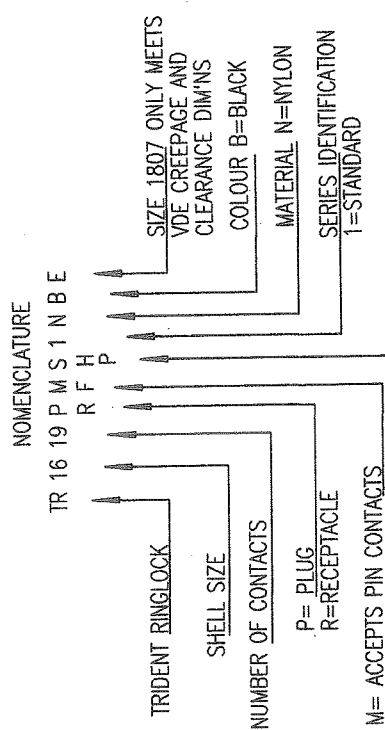

A	Blattanzahl korrigiert (10 Bierter)	STR	5.9.07
7	5007 LENGTHS CORRECTED	RWAM	8.7.97
6	K2863 LENGTH INCREASES ALL SIZES	RWAM	9.4.96

This drawing, associated documents and the contained information are the property of ITT Cannon. No part may be reproduced, disclosed to a third party or used without the permission of ITT Cannon.

DIMENSIONS IN :- mm  
TOLERANCES  
2 DEC ±  
1 DEC ±  
0 DEC ±  
ANGLES ±  
UNLESS OTHERWISE STATED

ISSUE	REVISIONS/SEC/NO/ DETAILS	DRAWN	AUDITED	DATE
5	K2727 -3 DELETED NOW 1 OF 11	RWAM		14.8.95
4	K2604 NOW 10 SHEETS	RWAM		20.3.95
3	K2373 NOW 8 SHTS.	RWAM		12.7.94
2	K1823	RWAM		11.92
1	REDRAWN CAD	N.A.S.P/MALL		JAN.91

**ITT Cannon**  
1991  
ANSI CLOSE  
BASINGSTOCK HAWKS.  
R022 48W  
TEL. 01256 311200  
FAX. 01256 23356

TITLE	DRG No	SHEET
RINGLOCK CONNECTORS.	86000-99	1 OF 10
MATERIAL		

ORDERING INFORMATION.

STANDARD RECEPTACLE.

STANDARD RECEPTACLE FOR SOCKET CONTACTS.

TR \*\*\* R F S 1 N B

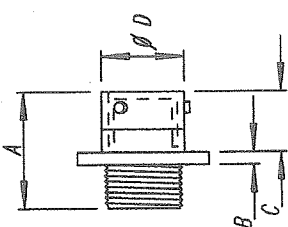
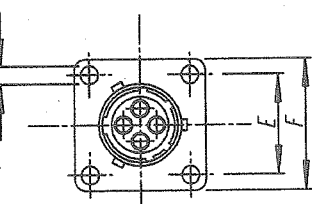

PANEL CUT OUT.

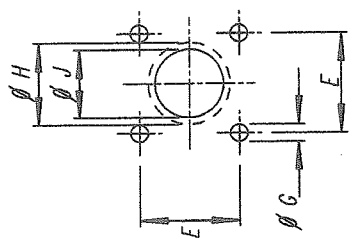

DIM. J = FLANGE IN FRONT OF PANEL.  
DIM. H = FLANGE IN REAR OF PANEL.

No. OF CONTACT POSITIONS.	SHELL SIZE	DIMENSIONS (mm)										ORDER CODE.
		A MAX	B ±0,15	C ±0,2	∅ D MAX	E ±0,08	F ±0,25	∅ G ±0,1	∅ H ±0,1	∅ J ±0,1		
4	10	24,0	2,3	11,15	15,0	18,0	23,5	3,25	17,3	15,1	192922-1190	
7 VDEU	18	32,5	2,5	18,20	28,5	27,0	33,3	3,25	31,3	27,8	192990-1300	
8	12	25,8	2,3	11,35	19,0	20,5	26,2	3,25	21,8	18,2	192922-1200	
12	14	24,0	2,3	11,35	22,2	22,6	28,15	3,25	25,0	21,4	192922-1210	
19	16	25,8	2,3	11,15	25,40	24,2	30,50	3,25	28,1	24,6	192922-1220	
23	18	25,8	2,5	11,35	28,50	26,9	33,3	3,25	31,3	27,8	192990-1290	
28	20	27,0	2,5	14,50	31,7	29,2	36,5	3,25	34,5	30,9	192922-1230	
35	22	28,0	3,5	14,50	34,9	31,6	39,7	3,25	37,7	34,1	192922-1240	
48	24	30,3	3,5	15,30	38,05	34,45	42,9	3,9	40,9	37,3	192990-1310	

STANDARD PLUG.

ORDERING INFORMATION.

No. OF CONTACT POSITIONS.	SHELL SIZE	DIMENSIONS (mm)					ORDER CODE.
		∅ A +0,2	B max.	∅ C +0 -0,20	∅ D MAX	E -0,2	
4	10	21,6	31,2	11,00	12,30	19,2	192922-1250
7 VDEU	18	34,3	33,2	22,5	24,0	19,2	192990-1330
8	12	24,8	31,2	13,9	15,23	19,2	192922-1260
12	14	28,0	31,2	17,1	18,40	19,2	192922-1270
19	16	31,2	31,2	19,9	21,48	19,2	192922-1280
23	18	34,3	31,2	22,4	24,00	19,2	192990-1320
28	20	37,5	31,2	25,5	27,50	19,2	192922-1290
35	22	40,7	31,2	28,5	30,50	19,2	192922-1300
48	24	43,9	31,2	31,6	33,50	19,2	192990-1340

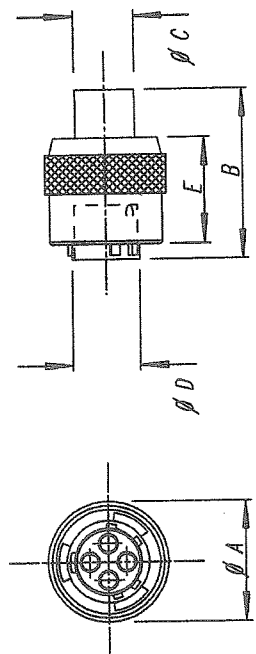

STANDARD CONNECTOR.

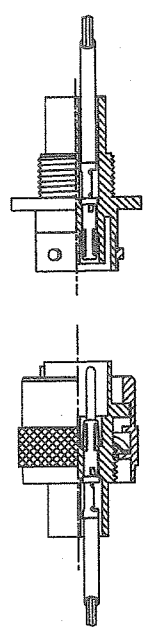

STANDARD PLUG FOR PIN CONTACTS

TR \*\*\* P M S 1 N B

ISSUE	REVISIONS, EC/ANDI DETAILS	DRAWN	AUDITED	DATE
1	REDRAWN CAD	M. ASPINALL		JAN. 91
2				5,7,83
3				21.4.93
4				12.7.94
5				20.3.95
6				14.8.95
7				4.4.96
8				8.11.96
9				34,7 now 34,45
10				5.9.07

DIMENSIONS IN : - mm  
TOLERANCES  
2 DEC ±  
1 DEC ±  
0 DEC ±  
ANGLES ±  
UNLESS OTHERWISE STATED

This drawing, associated documents and the contained information are the property of ITT Cannon. No part may be reproduced, stored in a retrieval system, or used without the written permission of ITT Cannon.

**ITT Cannon**  
1991  
JMS CLOSE  
BUSINGSTAKE JMW.  
R022 48W  
TEL 01256 311200  
FAX 01256 23356

TITLE STANDARD RINGLOCK CONNECTORS.  
MATERIAL  
DRG No 86000-99  
SHEET 2 OF 10

REVERSED RECEPTACLE FOR PIN CONTACTS.

TR \*\*\* R M 1 N B

No. OF CONTACT POSITIONS.	SHELL SIZE	DIMENSIONS (mm)							ORDER CODE.		
		A MAX	B ±0,15	C ±0,2	∅ D MAX	E ±0,08	F ±0,25	∅ G ±0,1		∅ H ±0,1	∅ J ±0,1
4	10	31,5	2,3	11,35	15,0	18,0	23,5	3,25	17,3	15,1	192926-0440
7 VDEU	18	34,2	2,5	17,8	28,5	27,0	33,3	3,25	31,3	27,9	192990-1360
8	12	31,5	2,3	11,35	19,0	20,5	26,2	3,25	21,8	18,2	192926-0450
12	14	31,5	2,3	11,35	22,2	22,6	28,15	3,25	25,0	21,4	192926-0460
19	16	31,5	2,3	11,35	25,40	24,2	30,50	3,25	28,1	24,6	192926-0470
23	18	31,5	2,5	11,35	28,60	26,9	33,3	3,25	31,3	27,9	192990-1350
28	20	33,0	2,5	14,55	31,7	29,2	36,5	3,25	34,5	30,9	192926-0480
35	22	33,0	3,5	14,55	34,9	31,6	39,7	3,25	37,7	34,1	192926-0490
48	24	33,0	3,5	15,35	38,05	34,45	42,9	3,9	40,9	37,3	192990-1370

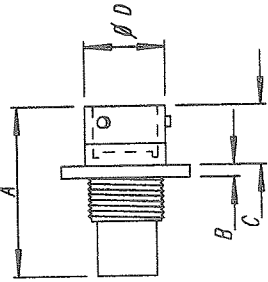

PANEL CUT OUT.

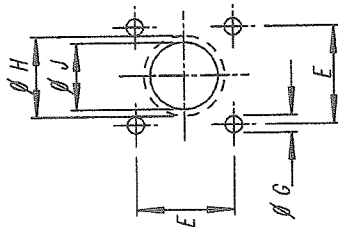

DIM. J = FLANGE IN FRONT OF PANEL.  
DIM. H = FLANGE IN REAR OF PANEL.

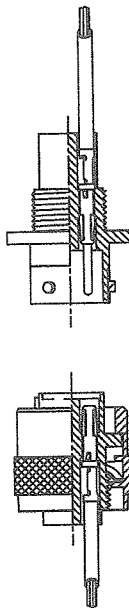

REVERSED CONNECTOR.

ISSUE	REVISIONS/SEC./NDI DETAILS	DRAWN	AUDITED	DATE
8	S 007 LENGTHS CORRECTED	RWAM		5.9.07
7	K2974 34,7 NOW 34,45	RWAM		9.7.97
6	SEE SHEET 1	RWAM		8.11.96
5	K2727 LENGTH, 11SHTS	RWAM		4.4.96
4	K2604 NOW 10 SHEETS	RWAM		15.8.95
3	K2573 NOW 8 SHTS.	RWAM		20.3.95
2	K1823	RWAM		12.7.94
1	2829	RWAM		23.4.93
	REDRAWN CAD	N.A.SPINALL		5.7.88
				JAN.91

This drawing, associated documents and the contained information are the property of ITT Cannon and may be reproduced, stored in a retrieval system, or used without the written permission of ITT Cannon.

DIMENSIONS IN :- mm  
TOLERANCES  
2 DEC ±  
1 DEC ±  
0 DEC ±  
ANGLES ±  
UNLESS OTHERWISE STATED

1991  
JMS CLOSE  
BAGINSGTÖRE, SWEDEN  
TEL. 071259 1190  
FAX. 071259 23366

TITLE REVERSED RINGLOCK CONNECTORS.

MATERIAL \_\_\_\_\_ DRG No 86000-99

SHEET 3 OF 10

ORDERING INFORMATION.

REVERSED RECEPTACLE.

REVERSED PLUG.

No. OF CONTACT POSITIONS.	SHELL SIZE	DIMENSIONS (mm)				ORDER CODE.	
		∅ A +0,2	B max.	∅ C+0,2 -0,08	∅ D MAX		
4	10	21,6	26,10	11,00	12,39	19,2	192926-0500
7 VDEU	18	34,3	31,50	22,3	24,0	19,2	192990-1390
8	12	24,8	25,60	13,9	15,20	19,2	192926-0510
12	14	28,0	26,80	17,1	18,20	19,2	192926-0520
19	16	31,2	27,60	20,0	21,40	19,2	192926-0530
23	18	34,3	25,60	22,3	24,00	19,2	192990-1380
28	20	37,5	31,10	25,6	27,0	19,2	192926-0540
35	22	40,7	31,10	28,4	30,10	19,2	192926-0550
48	24	43,9	31,10	31,5	33,30	19,2	192990-1400

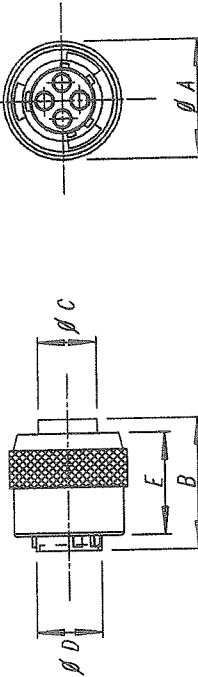

REVERSED PLUG FOR SOCKET CONTACTS.

TR \*\*\* P F 1 N B

**CABLE CLAMPS-TYPE HC (WITH SEAL).**

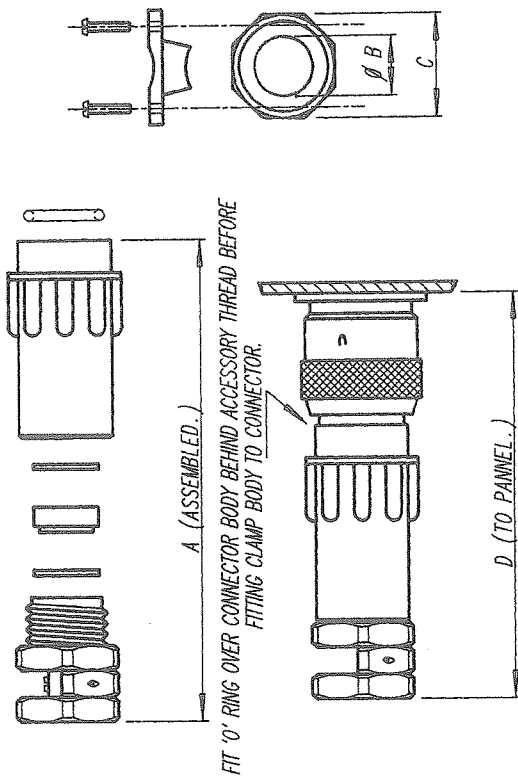

**TR \*\* AHC 1 N ORDERING INFORMATION.**

**CABLE CLAMP HC.**

SHELL SIZE.	DIMENSIONS (mm).				ORDER CODE.
	A MAX.	Ø B MAX.	C ±0,2	D MAX.	
10	55,0	11,1	18,8	76,5	192990-1530
12	58,0	13,6	20,8	77,8	192990-1540
14	65,0	14,6	22,8	85,5	192990-1550
16	69,0	16,6	24,7	89,8	192990-1560
18	73,0	16,6	24,7	93,0	192990-1570
20	83,0	22,1	31,8	107,5	192990-1580
22	90,0	22,1	31,8	114,5	192990-1590
24	105,0	29,6	41,8	128,5	192990-1600

5	K2727 O'RING ADDED HC	RWAM	14.8.95	A	Bilanzahl korrigiert (10 Blätter)	STR	5.9.07
4	K2804 NOW 10 SHEETS	RWAM	20.3.95	76	ISO21 SR CORRECTED RWAM 2.10.97		
3	K2373 NOW8 SHTS.	RWAM	12.7.94				
2	K1559	RWAM	11.92				
1	2612	RWAM	11.4.88				
	REDRAWN CAD	N.ASPINALL	JAN.91				
ISSUE	REVISIONS/EC/NDI DETAILS	DRAWN	AUDITED	DATE			

**CABLE CLAMPS-TYPE SR (WITHOUT SEAL).**

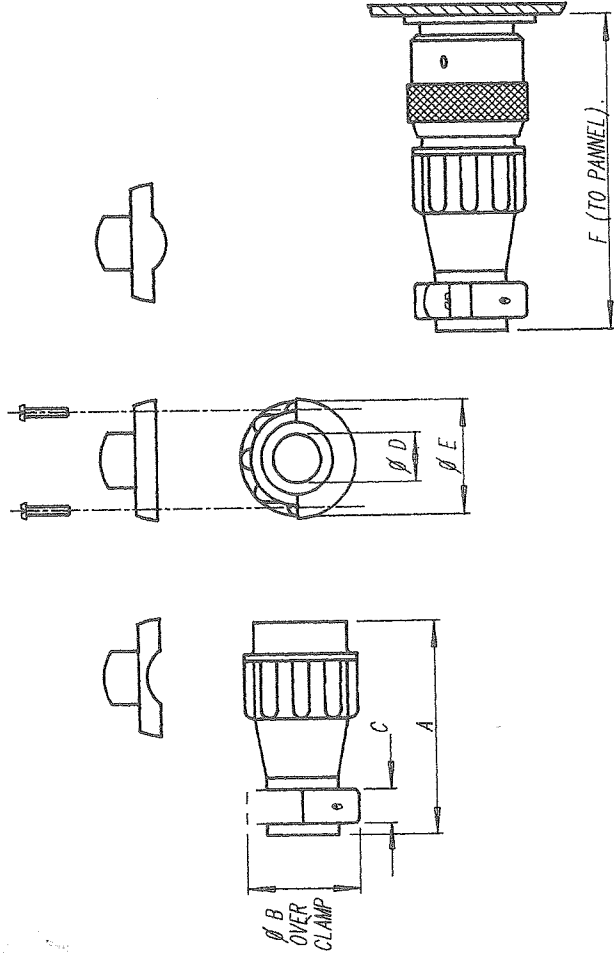

**TR \*\* ASR 1 N ORDERING INFORMATION.**

**CABLE CLAMP SR.**

SHELL SIZE.	DIMENSIONS (mm).						ORDER CODE.
	A ±0,15	Ø B MAX.	C ±0,15	Ø D MAX.	Ø E ±0,15	F MAX.	
10	39,55	21,5	6,4	9,3	20,60	61,3	192922-1310
12	39,55	24,9	6,4	13,3	24,20	61,3	192922-1320
14	45,60	27,0	6,4	14,3	26,15	67,1	192922-1330
16	45,60	30,1	6,4	17,5	29,35	67,1	192922-1340
18	49,40	32,0	7,0	19,5	31,20	70,8	192990-1510
20	54,15	34,3	7,0	21,5	33,50	79,3	192922-1350
22	59,80	37,1	8,2	23,5	36,00	85,3	192922-1360
24	64,15	41,8	8,2	27,6	40,80	90,8	192990-1520

1991 ©

**ITT Cannon**  
 JMS, GLE, HWS  
 BUSINESS UNIT  
 TEL 01256 317200  
 FAX 01256 23356

TITLE: **RINGLOCK ACCESSORIES.**

MATERIAL: \_\_\_\_\_

DRG No: **86000-99**

SHEET: **4 OF 10**

DUST CAPS.

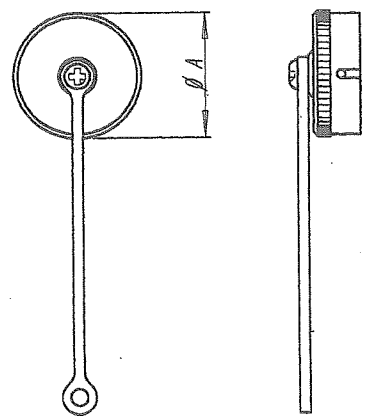

TR \*\* ADCR 1 N

DUST CAPS. ORDERING INFORMATION.

FOR SHELL SIZE.	DIMENSIONS ø A	ORDER CODE.
10	21,8	192900-0376
12	25,4	192900-0377
14	28,6	192900-0378
16	31,7	192900-0379
18	34,9	192900-0380
20	38,1	192900-0381
22	41,2	192900-0382
24	44,4	192900-0383

ADAPTORS.

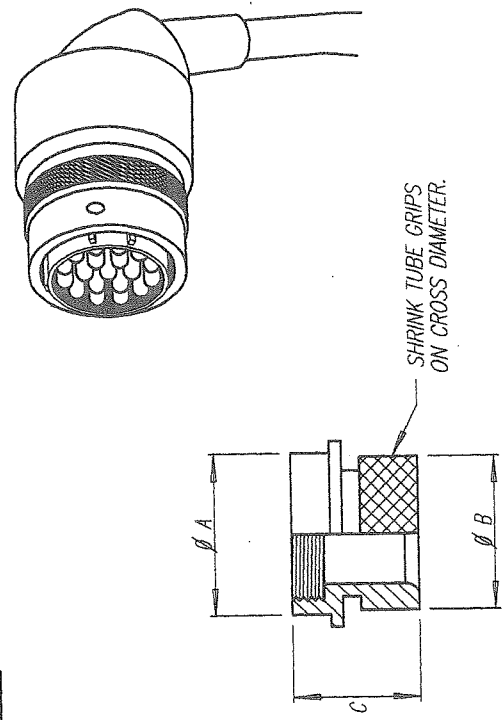

TR \*\* AAD 1 N

ADAPTORS. ORDERING INFORMATION.

FOR SHELL SIZE.	DIMENSIONS.			ORDER CODE.
	ø A	ø B +0,5	C	
10	21,0	18,4	19,2	192990-1430
12	24,0	23,7	19,2	192990-1440
14	27,0	24,5	19,2	192990-1450
16	30,2	29,8	21,5	192990-1460
18	33,3	32,0	21,5	192990-1470
20	36,5	36,1	22,8	192990-1480
22	39,7	38,5	22,8	192990-1490
24	42,9	41,6	21,9	192990-1500

ISSUE	REVISIONS, EC/INDI DETAILS	DRAWN	AUDITED	DATE
1		N.ASP/NALL		JAN.90
2	PLASTIC DUST CAP	RWAM		19.11.93
3	K2373 NOW 8 SHTS.	RWAM		12.7.94
4	K2604 NOW 10 SHEETS	RWAM		20.3.95
5	K2727 NOW 11 SHTS	RWAM		15.8.95

This drawing, associated documents and the contained information are the property of IIT Cannon. No part may be reproduced, disclosed to or without the written permission of IIT Cannon.

DIMENSIONS IN : - mm  
 TOLERANCES  
 2 DEC ±  
 1 DEC ±  
 0 DEC ±  
 ANGLES ±  
 UNLESS OTHERWISE STATED

**IIT Cannon**  
 JMS. CLOSE,  
 BASINGSTORKE, JMWIS.  
 RG22 4BW  
 TEL. 01256 31200  
 FAX. 01256 23366

1991 ©

TITLE RINGLOCK ACCESSORIES. (A)

MATERIAL \_\_\_\_\_  
 DRG No 86000-99  
 SHEET 5 OF 10

**STANDARD RECEPTACLE FOR SOCKET CONTACTS.**

TR \*\* R F H 1 N B

**PANEL CUT OUT.**

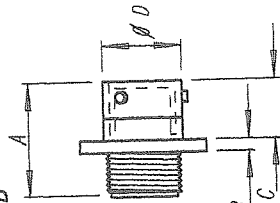
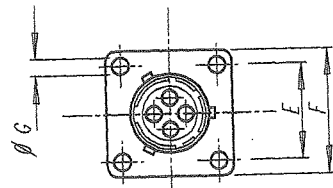

DIM. J = FLANGE IN FRONT OF PANEL.  
DIM. H = FLANGE IN REAR OF PANEL.

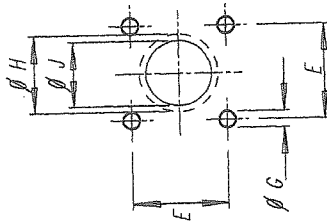

**STANDARD RECEPTACLE**

No. OF CONTACT POSITIONS.	SHELL SIZE	SERIES H-1 ORDER CODE.
4	10	192990-1660
7 IDEU	16	192990-1700
8	12	192990-1670
12	14	192990-1680
19	16	192990-1690
23	18	192990-1710
28	20	192990-1720
35	22	192990-1730
48	24	192990-1740
TYPICAL NOMENCLATURE		TR----R FH-1NB

**STANDARD PLUG.**

No. OF CONTACT POSITIONS.	SHELL SIZE	SERIES -3 ORDER CODE.
4	10	192922-1250
7 IDEU	16	192990-1330
8	12	192922-1260
12	14	192922-1270
19	16	192922-1280
23	18	192990-1320
28	20	192922-1290
35	22	192922-1300
48	24	192990-1340
TYPICAL NOMENCLATURE		TR----PMS-1NB

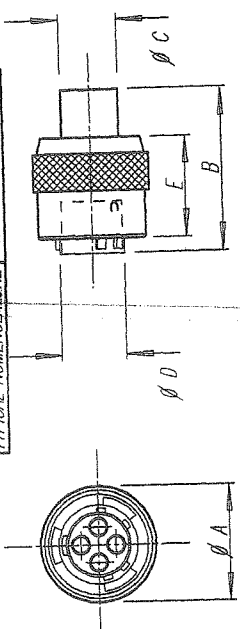

**STANDARD PLUG FOR PIN CONTACTS**

TR \*\* P M S 1 N B

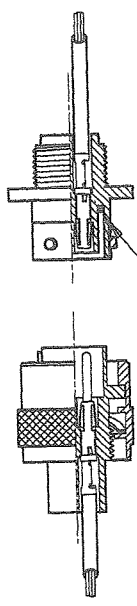

**STANDARD CONNECTOR.**

'O' RING ALL 'H' VERSIONS

FOR DIMENSIONS SEE SHEET 3

ISSUE	REVISIONS/EC/INTL DETAILS	DRAWN	AUDITED	DATE
1	REDRAWN CAD	N.ASPINALL		JAN.91
2	K1823	RWAM		5.7.83
3	K2373 NOW 8 SHTS. WAS SHT 3	RWAM		21.4.93
4	K2604 NOW 10 SHEETS	RWAM		21.3.95
	K2721 NO 'O' RING 11 SHEETS	RWAM		14.8.95
A	Bhattachaji korrigiert (10 Blätter)	STR		5.9.07

This drawing, associated documents and the contained information are the property of IIT Cannon. No part may be reproduced, stored in a retrieval system, or used without the written permission of IIT Cannon

DIMENSIONS IN : - mm  
TOLERANCES  
2 DEC ±  
1 DEC ±  
0 DEC ±  
ANGLES ±  
UNLESS OTHERWISE STATED

**IIT Cannon**  
JAYS CLUSE  
BASINGSTOCK, HANTS.  
02256 511200  
TEL. 01256 511200  
FAX. 01256 233556

1991 (C)

**STANDARD RINGLOCK CONNECTORS. H (SEALED) VERSION**

TITLE MATERIAL

DRG No 86000-99

SHEET 6 OF 10

**REVERSED RECEPTACLE FOR PIN CONTACTS.**

TR \*\* R M H 1 N B

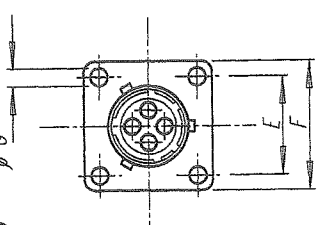

PANEL CUT OUT.

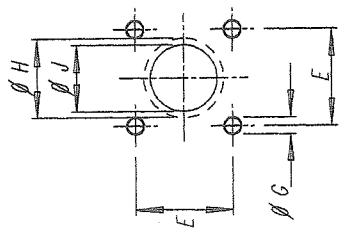

DIM. J = FLANGE IN FRONT OF PANEL.  
DIM. H = FLANGE IN REAR OF PANEL.

**REVERSED RECEPTACLE.**

No. OF CONTACT POSITIONS.	SHELL SIZE	SERIES H-1 ORDER CODE.
4	10	192990-1760
7 VDEU	18	192990-1800
8	12	192990-1770
12	14	192990-1780
19	16	192990-1790
23	18	192990-1810
28	20	192990-1820
35	22	192990-1830
48	24	192990-1840
TYPICAL NOMENCLATURE		TR---RMH-INB

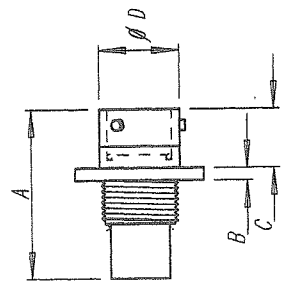

**REVERSED PLUG.**

No. OF CONTACT POSITIONS.	SHELL SIZE	SERIES -1 ORDER CODE.
4	10	192926-0500
7 VDEU	18	192990-1390
8	12	192926-0510
12	14	192926-0520
19	16	192926-0530
23	18	192990-1380
28	20	192926-0540
35	22	192926-0550
48	24	192990-1400
TYPICAL NOMENCLATURE		TR---PFS-3NB

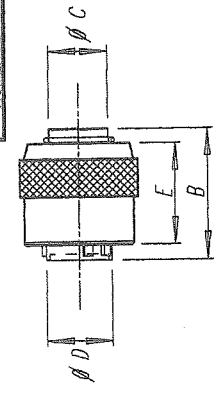

**REVERSED PLUG FOR SOCKET CONTACTS.**

TR \*\* P F H 1 N B

**REVERSED RECEPTACLE FOR PIN CONTACTS.**

TR \*\* R M H 1 N B

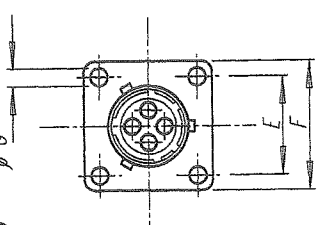

PANEL CUT OUT.

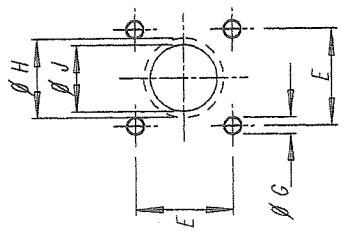

DIM. J = FLANGE IN FRONT OF PANEL.  
DIM. H = FLANGE IN REAR OF PANEL.

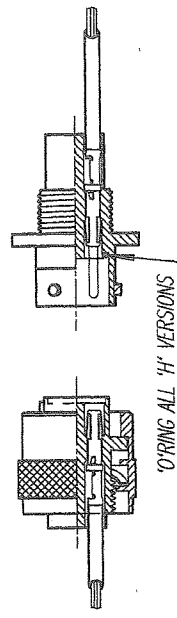

**REVERSED CONNECTOR.**

SEE SHEET 2 FOR DIMENSIONS

Blattanzahl korrigiert (10 Blätter)	STR	DATE
5 K2727 NOV RING 11 SHTS	RWAM	5.9.07
4 K2604 NOV 10 SHEETS	RWAM	14.8.95
3 K2373 NOV 8 SHTS.	RWAM	21.3.95
2 K1823	RWAM	12.7.94
1 REDRAWN CAD	N.ASPHALL	23.4.93
REVISIONS/EC/INDI DETAILS	DRAWN	5.7.88
ISSUE	AUDITED	14.11.91

This drawing, associated documents and the contained information are the property of IIT Cannon. No part may be reproduced, stored in a retrieval system or used without the written permission of IIT Cannon.

DIMENSIONS IN :- mm  
TOLERANCES  
2 DEC ±  
1 DEC ±  
0 DEC ±  
ANGLES ±  
UNLESS OTHERWISE STATED

**IIT Cannon**  
IANS CLOSE  
BASINGSTOKE, HANTS.  
RG22 4BW  
TEL. 01256 31200  
FAX. 01256 23356

1991 ©

TITLE: REVERSED RINGLOCK CONNECTORS. H (SEALED) VERSION

MATERIAL: \_\_\_\_\_

DRG No: 86600-99

SHEET 7 OF 10





86000-99

DO NOT SCALE / IF IN DOUBT ASK

**ORDERING INFORMATION.**

No. OF CONTACT POSITIONS.	SHELL SIZE	DIMENSIONS (mm)					ORDER CODE SINGLE PIECE
		$\phi A$ +0,2	B max.	$\phi C$ +0 -0,20	$\phi D$ MAX	E -0,2	
4	10		31,2	11,00	12,30	19,2	
7	18		33,0	22,5	24,0	19,2	
8	12		31,2	13,9	15,23	19,2	
12	14		31,2	17,1	18,40	19,2	
19	16	32,5	31,2	19,9	21,48	20,25	192900-0593
23	18		31,2	22,4	24,00	19,2	
28	20		31,2	25,5	27,50	19,2	
35	22		31,2	28,5	30,50	19,2	
48	24	45,5	31,2	31,6	33,50	20,25	192900-0553

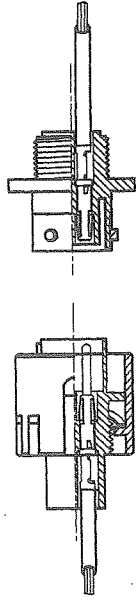
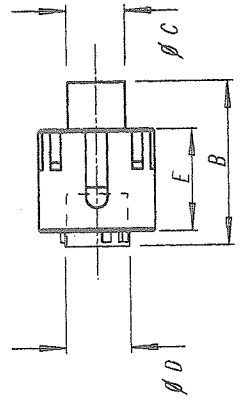
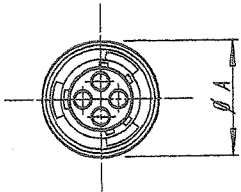

STANDARD CONNECTOR.

STANDARD PLUG FOR PIN CONTACTS

TR \*\*\* P M P 1 N B



MATES WITH ANY CORRESPONDING RECEPTACLE

Iss	DCN	Revision Details	Drawn	Date	Chk'd	First Used On	Ref.	TREATMENT	FINISH	MATERIAL	 3rd ANGLE PROJECTION Unless Otherwise Stated Remove Burrs and Break Sharp Edges 0.13 mm max.	Drawing Tolerance Unless Otherwise Stated Metric X = ±.40 X.X = ±.20 X.XX = ±.010 X.XXX = ±.005 X.XXX = ±.10 FRACTIONS = ±1/64 Imperial Angles X° = ±2' X' = ±30'	Dimensions are in mm Surface Finish $\nabla$	Parity Code
A	3170W	Blattanzahl korrigiert (10 Blätter)	STR	5.9.07										
2	K2727	NOW 11 SHEETS	RWAM	15.8.95										
1	K2604	PROVISIONAL RELEASE	RWAM	15/03/95										
TITLE RINGLOCK CONNECTORS STANDARD RANGE PLASTIC COUPLING NUTS Drg No. 86000-99 Original Scale Sheet 9 of 10											JAYS CLOSE, VIABLES ESTATE, BASINGSTOKE, HANTS. RG22 4BW. U.K. THIS IS ISSUED IN STRICT CONFIDENCE ON CONDITION THAT IT IS NOT USED AS A BASIS FOR MANUFACTURE OR SALE AND THAT IT IS NOT COPIED, REPRINTED OR DISCLOSED TO A THIRD PARTY EITHER WHOLLY OR IN PART WITHOUT THE PRIOR WRITTEN CONSENT OF IIT CANON (UK). © 1994			

ACCESSORY THREAD NOMINAL SIZES  
 PLUG AND RECPTACLE, STANDARD AND REVERSED CONNECTORS

SHELL 10	SHELL 12	SHELL 14	SHELL 16	SHELL 18	SHELL 18	SHELL 20	SHELL 22	SHELL 24
LAYOUT 04	LAYOUT 08	LAYOUT 12	LAYOUT 19	LAYOUT 23	LAYOUT 23	LAYOUT 23	LAYOUT 35	LAYOUT 48
RINGLOCK 9/16-24 UNEF	11/16-24 UNEF	13/16-20 UNEF	15/16-20 UNEF	1 1/16-18 UNEF	1 1/16-18 UNEF	1 3/16-18 UNEF	1 5/16-18 UNEF	1 7/16-18 UNEF
NEPTUNE LAYOUT 0-12			LAYOUT 0-19 2-13					LAYOUT 0-48 4-20 4-28 12-19
JAM NUT ONLY LAYOUT 0-12		1 3/16-18 UNEF	1 3/16-18 UNEF					1 11/16-18 UNEF

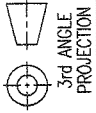
NOTE  
 DUE TO SHRINKAGE VARIATIONS WITH PLASTIC MATERIALS THE SIZES LISTED ABOVE  
 MAY NOT FULLY MEET SPECIFICATION DIMENSIONS; --- BEFORE TOOLING OR MAKING  
 MATING PARTS CONSULT FACTORY.

 3rd ANGLE PROJECTION		MATERIAL  FINISH  TREATMENT		Drawing Tolerance Unless Otherwise Stated Metric: X.X = ±.40, X.XX = ±.020, X.XXX = ±.010, X.XXX = ±.005, FRACTIONS = ±1/64 Imperial: X° = +2°, X' X' = ±30° Angles: X° X' = ±30° Surface Finish: 		Dimensions are in INCHES		Parity Code	
Ref. First Used On		UNLESS OTHERWISE STATED REMOVE BURRS AND BREAK SHARP EDGES 0.13 mm max.		ITT Cannon JAYS CLOSE, VIBLES ESTATE, BASINGSTOKE, HANTS, RG22 4BW. U.K.		TITLE RINGLOCK AND NEPTUNE ACCESSORY THREAD NOMINAL SIZES		Drg No. 86000-99	
Revision Details Blattanzahl korrigiert (10 Blätter) PROVISIONAL RELEASE K2727		Date 14/08/85		Drawn STR		Original Scale 1:1		Sheet 10 of 10	