

# INA828 50- $\mu\text{V}$ Offset, 7-nV/ $\sqrt{\text{Hz}}$ Noise, Low-Power, Precision Instrumentation Amplifier

## 1 Features

- Precision Instrumentation Amplifier Evolution:
  - Second Generation: INA828
  - First Generation: INA128
- Low Offset Voltage: 50  $\mu\text{V}$ , MAX
- Gain Drift: 5 ppm/ $^{\circ}\text{C}$  ( $G = 1$ ), 50 ppm/ $^{\circ}\text{C}$  ( $G > 1$ )
- Noise: 7 nV/ $\sqrt{\text{Hz}}$
- Bandwidth: 2 MHz ( $G = 1$ ), 260 kHz ( $G = 100$ )
- Stable with 1-nF Capacitive Loads
- Inputs Protected Up to  $\pm 40\text{ V}$
- Common-Mode Rejection:
  - 110 dB, MIN ( $G = 10$ )
- Power-Supply Rejection: 100 dB, MIN ( $G = 1$ )
- Supply Current: 650  $\mu\text{A}$ , MAX
- Supply Range:
  - Single Supply: 4.5 V to 36 V
  - Dual Supply:  $\pm 2.25\text{ V}$  to  $\pm 18\text{ V}$
- Specified Temperature Range:  $-40^{\circ}\text{C}$  to  $+125^{\circ}\text{C}$
- Package: 8-Pin SOIC

## 2 Applications

- Industrial Process Controls
- Circuit Breakers
- Battery Testers
- ECG Amplifiers
- Power Automation
- Medical Instrumentation
- Portable Instrumentation

### INA828 Simplified Internal Schematic

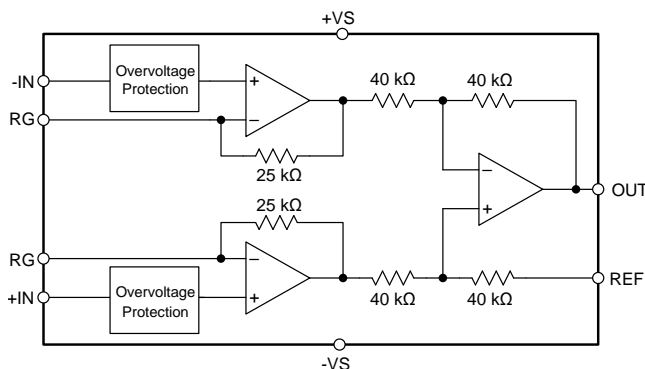

Copyright © 2017, Texas Instruments Incorporated

## 3 Description

The INA828 is a high-precision instrumentation amplifier that offers low power consumption and operates over a very wide single- or dual-supply range. A single external resistor sets any gain from 1 to 1000. The device offers excellent precision due to the use of new super-beta input transistors which provide exceptionally low input offset voltage, offset voltage drift, input bias current, and input voltage and current noise. Additional circuitry protects the inputs against overvoltage up to  $\pm 40\text{ V}$ .

The INA828 is optimized to provide excellent common-mode rejection ratio. At  $G = 1$ , the common-mode rejection ratio exceeds 90 dB across the full input common-mode range. The device is well-suited for low-voltage operation from a 5-V single supply as well as dual supplies up to  $\pm 18\text{ V}$ . Finally, INA828 is available in an 8-pin SOIC package and specified over the  $-40^{\circ}\text{C}$  to  $+125^{\circ}\text{C}$  temperature range.

### Device Information<sup>(1)</sup>

PART NUMBER	PACKAGE	BODY SIZE (NOM)
INA828	SOIC (8)	4.90 mm x 3.91 mm

(1) For all available packages, see the orderable addendum at the end of the data sheet.

### Typical Distribution of Input Offset Voltage Drift

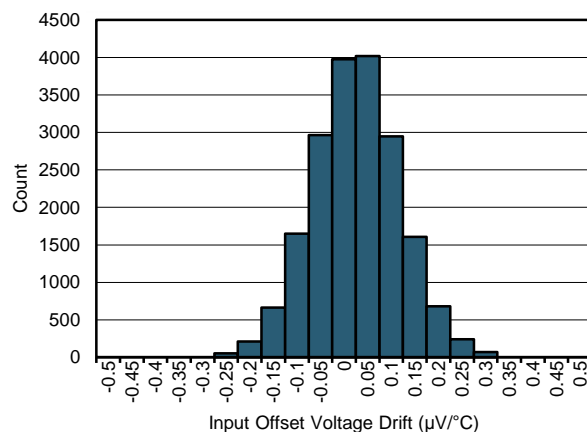

## Table of Contents

<b>1 Features</b> .....	<b>1</b>	8.1 Reference Terminal.....	<b>22</b>
<b>2 Applications</b> .....	<b>1</b>	8.2 Input Bias Current Return Path.....	<b>24</b>
<b>3 Description</b> .....	<b>1</b>	8.3 PCB Assembly Effects on Precision .....	<b>25</b>
<b>4 Revision History</b> .....	<b>2</b>	8.4 Typical Application .....	<b>26</b>
<b>5 Pin Configuration and Functions</b> .....	<b>3</b>	8.5 Other Application Examples.....	<b>28</b>
<b>6 Specifications</b> .....	<b>4</b>	<b>9 Power Supply Recommendations</b> .....	<b>29</b>
6.1 Absolute Maximum Ratings .....	<b>4</b>	<b>10 Layout</b> .....	<b>29</b>
6.2 ESD Ratings .....	<b>4</b>	10.1 Layout Guidelines .....	<b>29</b>
6.3 Recommended Operating Conditions.....	<b>4</b>	10.2 Layout Example .....	<b>30</b>
6.4 Thermal Information .....	<b>4</b>	<b>11 Device and Documentation Support</b> .....	<b>31</b>
6.5 Electrical Characteristics.....	<b>5</b>	11.1 Documentation Support .....	<b>31</b>
6.6 Typical Characteristics.....	<b>7</b>	11.2 Receiving Notification of Documentation Updates	<b>31</b>
<b>7 Detailed Description</b> .....	<b>16</b>	11.3 Community Resources.....	<b>31</b>
7.1 Overview .....	<b>16</b>	11.4 Trademarks .....	<b>31</b>
7.2 Functional Block Diagram .....	<b>16</b>	11.5 Electrostatic Discharge Caution.....	<b>31</b>
7.3 Feature Description.....	<b>17</b>	11.6 Glossary .....	<b>31</b>
7.4 Device Functional Modes.....	<b>21</b>	<b>12 Mechanical, Packaging, and Orderable</b>	
<b>8 Application and Implementation</b> .....	<b>22</b>	<b>Information</b> .....	<b>31</b>

## 4 Revision History

Changes from Original (August 2017) to Revision A	Page
• Changed MAX value for G = 1 in "GE" row from "±0.020%" to "±0.025%" .....	<b>5</b>

## 5 Pin Configuration and Functions

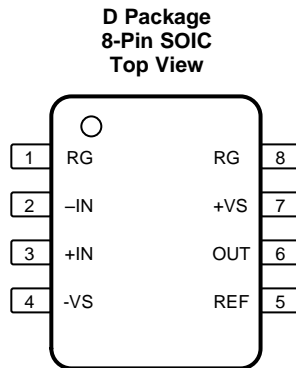

### Pin Functions

PIN		I/O	DESCRIPTION
NAME	NO.		
RG	1	—	Gain setting pin. Place a gain resistor between pin 1 and pin 8.
	8		
-IN	2	I	Negative (inverting) input
+IN	3	I	Positive (noninverting) input
-VS	4	—	Negative supply
REF	5	I	Reference input. This pin must be driven by a low impedance source.
OUT	6	O	Output
+VS	7	—	Positive supply

## 6 Specifications

### 6.1 Absolute Maximum Ratings

over operating free-air temperature range (unless otherwise noted)<sup>(1)</sup>

		MIN	MAX	UNIT
Supply voltage		-18	18	V
Signal input pins	Voltage	-40	40	V
	REF pin	-18	18	
Output short-circuit <sup>(2)</sup>		Continuous		
Temperature	Operating, T <sub>A</sub>	-50	150	°C
	Junction, T <sub>J</sub>		175	
	Storage, T <sub>stg</sub>	-65	150	

- (1) Stresses beyond those listed under *Absolute Maximum Ratings* may cause permanent damage to the device. These are stress ratings only, which do not imply functional operation of the device at these or any other conditions beyond those indicated under *Recommended Operating Conditions*. Exposure to absolute-maximum-rated conditions for extended periods may affect device reliability.
- (2) Short-circuit to V<sub>S</sub> / 2.

### 6.2 ESD Ratings

		VALUE	UNIT
V <sub>(ESD)</sub> Electrostatic discharge	Human-body model (HBM), per ANSI/ESDA/JEDEC JS-001 <sup>(1)</sup>	±1500	V
	Charged-device model (CDM), per JEDEC specification JESD22-C101 <sup>(2)</sup>	±750	

- (1) JEDEC document JEP155 states that 500-V HBM allows safe manufacturing with a standard ESD control process.
- (2) JEDEC document JEP157 states that 250-V CDM allows safe manufacturing with a standard ESD control process.

### 6.3 Recommended Operating Conditions

over operating free-air temperature range (unless otherwise noted)

		MIN	MAX	UNIT
Supply voltage	Single supply	4.5	36	V
	Dual supply	±2.25	±18	
Specified temperature		-40	125	°C
Operating temperature		-50	150	°C

### 6.4 Thermal Information

THERMAL METRIC <sup>(1)</sup>		INA828	UNIT
		D (SOIC)	
		8 PINS	
R <sub>θJA</sub>	Junction-to-ambient thermal resistance	119.6	°C/W
R <sub>θJC(top)</sub>	Junction-to-case (top) thermal resistance	66.3	°C/W
R <sub>θJB</sub>	Junction-to-board thermal resistance	61.9	°C/W
Ψ <sub>JT</sub>	Junction-to-top characterization parameter	20.5	°C/W
Ψ <sub>JB</sub>	Junction-to-board characterization parameter	61.4	°C/W
R <sub>θJC(bot)</sub>	Junction-to-case (bottom) thermal resistance	n/a	°C/W

- (1) For more information about traditional and new thermal metrics, see the [Semiconductor and IC Package Thermal Metrics](#) application report.

## 6.5 Electrical Characteristics

at  $T_A = 25^\circ\text{C}$ ,  $V_S = \pm 15\text{ V}$ ,  $R_L = 10\text{ k}\Omega$ ,  $V_{\text{REF}} = 0\text{ V}$ , and  $G = 1$  (unless otherwise noted)

PARAMETER		TEST CONDITIONS	MIN	TYP	MAX	UNIT
<b>INPUT</b>						
$V_{\text{OSI}}$	Input stage offset voltage <sup>(1)(2)</sup>	$G = 100$ , RTI		20	50	$\mu\text{V}$
		$T_A = -40^\circ\text{C}$ to $+125^\circ\text{C}$ <sup>(3)</sup>			90	$\mu\text{V}$
		vs temperature, $T_A = -40^\circ\text{C}$ to $+125^\circ\text{C}$				0.5
$V_{\text{OSO}}$	Output stage offset voltage <sup>(1)(2)</sup>	$G = 1$ , RTI		50	250	$\mu\text{V}$
		$T_A = -40^\circ\text{C}$ to $+125^\circ\text{C}$ <sup>(3)</sup>			500	$\mu\text{V}$
		vs temperature, $T_A = -40^\circ\text{C}$ to $+125^\circ\text{C}$				5
PSRR	Power-supply rejection ratio	$G = 1$ , RTI	110	120		dB
		$G = 10$ , RTI	114	130		
		$G = 100$ , RTI	130	135		
		$G = 1000$ , RTI	136	140		
$Z_{\text{id}}$	Differential impedance			100    1		$\text{G}\Omega$    pF
$Z_{\text{ic}}$	Common-mode impedance			100    10		$\text{G}\Omega$    pF
	RFI filter, -3-dB frequency			53		MHz
$V_{\text{CM}}$	Operating input range <sup>(4)</sup>		(V-) + 2		(V+) - 2	V
		$V_S = \pm 2.25\text{ V}$ to $\pm 18\text{ V}$ , $T_A = -40^\circ\text{C}$ to $+125^\circ\text{C}$	See Figure 48 to Figure 51			
	Input overvoltage range	$T_A = -40^\circ\text{C}$ to $+125^\circ\text{C}$			$\pm 40$	V
CMRR	Common-mode rejection ratio	At dc to 60 Hz, RTI, $V_{\text{CM}} = (V-) + 2\text{ V}$ to $(V+) - 2\text{ V}$ , $G = 1$	90	100		dB
		At dc to 60 Hz, RTI, $V_{\text{CM}} = (V-) + 2\text{ V}$ to $(V+) - 2\text{ V}$ , $G = 10$	110	120		
		At dc to 60 Hz, RTI, $V_{\text{CM}} = (V-) + 2\text{ V}$ to $(V+) - 2\text{ V}$ , $G = 100$	130	140		
		At dc to 60 Hz, RTI, $V_{\text{CM}} = (V-) + 2\text{ V}$ to $(V+) - 2\text{ V}$ , $G = 1000$	140	145		
<b>BIAS CURRENT</b>						
$I_{\text{B}}$	Input bias current	$V_{\text{CM}} = V_S / 2$		0.15	0.6	nA
		$T_A = -40^\circ\text{C}$ to $+125^\circ\text{C}$			2	
$I_{\text{OS}}$	Input offset current	$V_{\text{CM}} = V_S / 2$		0.15	0.6	nA
		$T_A = -40^\circ\text{C}$ to $+125^\circ\text{C}$			2	
<b>NOISE VOLTAGE</b>						
$e_{\text{NI}}$	Input stage voltage noise <sup>(5)</sup>	$f = 1\text{ kHz}$ , $G = 100$ , $R_S = 0\ \Omega$		7		$\text{nV}/\sqrt{\text{Hz}}$
		$f_{\text{B}} = 0.1\text{ Hz}$ to $10\text{ Hz}$ , $G = 100$ , $R_S = 0\ \Omega$		0.14		$\mu\text{V}_{\text{PP}}$
$e_{\text{NO}}$	Output stage voltage noise <sup>(5)</sup>	$f = 1\text{ kHz}$ , $R_S = 0\ \Omega$		90		$\text{nV}/\sqrt{\text{Hz}}$
		$f_{\text{B}} = 0.1\text{ Hz}$ to $10\text{ Hz}$ , $R_S = 0\ \Omega$		7.7		$\mu\text{V}_{\text{PP}}$
$I_{\text{n}}$	Noise current	$f = 1\text{ kHz}$		170		$\text{fA}/\sqrt{\text{Hz}}$
		$f_{\text{B}} = 0.1\text{ Hz}$ to $10\text{ Hz}$ , $G = 100$		4.7		$\text{pA}_{\text{PP}}$
<b>GAIN</b>						
G	Gain equation			$1 + (50\text{ k}\Omega / R_G)$		V/V
		Range of gain		1	1000	V/V
GE	Gain error	$G = 1$ , $V_O = \pm 10\text{ V}$		$\pm 0.005\%$	$\pm 0.025\%$	
		$G = 10$ , $V_O = \pm 10\text{ V}$		$\pm 0.025\%$	$\pm 0.15\%$	
		$G = 100$ , $V_O = \pm 10\text{ V}$		$\pm 0.025\%$	$\pm 0.15\%$	
		$G = 1000$ , $V_O = \pm 10\text{ V}$		$\pm 0.05\%$		
	Gain vs temperature <sup>(6)</sup>	$G = 1$ , $T_A = -40^\circ\text{C}$ to $+125^\circ\text{C}$			$\pm 5$	ppm/ $^\circ\text{C}$
		$G > 1$ , $T_A = -40^\circ\text{C}$ to $+125^\circ\text{C}$			$\pm 50$	

(1) Total offset, referred-to-input (RTI):  $V_{\text{OS}} = (V_{\text{OSI}}) + (V_{\text{OSO}} / G)$ .

(2) Offset drifts are uncorrelated. Input-referred offset drift is calculated using:  $\Delta V_{\text{OS(RTI)}} = \sqrt{[\Delta V_{\text{OSI}}]^2 + (\Delta V_{\text{OSO}} / G)^2}$ 

(3) Specified by characterization.

(4) Input voltage range of the INA828 input stage. The input range depends on the common-mode voltage, differential voltage, gain, and reference voltage. See *Typical Characteristic* curves Figure 48 through Figure 51 for more information.

(5) Total RTI voltage noise is equal to:  $e_{\text{N(RTI)}} = \sqrt{e_{\text{NI}}^2 + (e_{\text{NO}} / G)^2}$ 

(6) The values specified for  $G > 1$  do not include the effects of the external gain-setting resistor,  $R_G$ .

**Electrical Characteristics (continued)**

 at  $T_A = 25^\circ\text{C}$ ,  $V_S = \pm 15\text{ V}$ ,  $R_L = 10\text{ k}\Omega$ ,  $V_{REF} = 0\text{ V}$ , and  $G = 1$  (unless otherwise noted)

PARAMETER	TEST CONDITIONS	MIN	TYP	MAX	UNIT
Gain nonlinearity	$G = 1$ to $10$ , $V_O = -10\text{ V}$ to $+10\text{ V}$ , $R_L = 10\text{ k}\Omega$		1	10	ppm
	$G = 100$ , $V_O = -10\text{ V}$ to $+10\text{ V}$ , $R_L = 10\text{ k}\Omega$			15	
	$G = 1000$ , $V_O = -10\text{ V}$ to $+10\text{ V}$ , $R_L = 10\text{ k}\Omega$			20	
	$G = 1$ to $100$ , $V_O = -10\text{ V}$ to $+10\text{ V}$ , $R_L = 2\text{ k}\Omega$			30	
<b>OUTPUT</b>					
Voltage swing		$(V-) + 0.15$		$(V+) - 0.15$	V
Load capacitance stability			1000		pF
$Z_O$ Closed-loop output impedance	$f = 10\text{ kHz}$		1.3		$\Omega$
$I_{SC}$ Short-circuit current	Continuous to $V_S / 2$		$\pm 18$		mA
<b>FREQUENCY RESPONSE</b>					
BW Bandwidth, $-3\text{ dB}$	$G = 1$		2.0		MHz
	$G = 10$		640		kHz
	$G = 100$		260		
	$G = 1000$		33		
SR Slew rate	$G = 1$ , $V_O = \pm 10\text{ V}$		1.2		V/ $\mu\text{s}$
$t_S$ Settling time	0.01%, $G = 1$ to $100$ , $V_{STEP} = 10\text{ V}$		12		$\mu\text{s}$
	0.01%, $G = 1000$ , $V_{STEP} = 10\text{ V}$		40		
	0.001%, $G = 1$ to $100$ , $V_{STEP} = 10\text{ V}$		16		
	0.001%, $G = 1000$ , $V_{STEP} = 10\text{ V}$		50		
<b>REFERENCE INPUT</b>					
$R_{IN}$ Input impedance			40		k $\Omega$
Voltage range		$(V-)$		$(V+)$	V
Gain to output			1		V/V
Reference gain error			0.01%		
<b>POWER SUPPLY</b>					
$V_S$ Power-supply voltage	Single supply	4.5		36	V
	Dual supply	$\pm 2.25$		$\pm 18$	
$I_Q$ Quiescent current	$V_{IN} = 0\text{ V}$		600	650	$\mu\text{A}$
	vs temperature, $T_A = -40^\circ\text{C}$ to $+125^\circ\text{C}$			850	

## 6.6 Typical Characteristics

At  $T_A = 25^\circ\text{C}$ ,  $V_S = \pm 15\text{ V}$ ,  $R_L = 10\text{ k}\Omega$ ,  $V_{REF} = 0\text{ V}$ , and  $G = 1$  (unless otherwise noted)

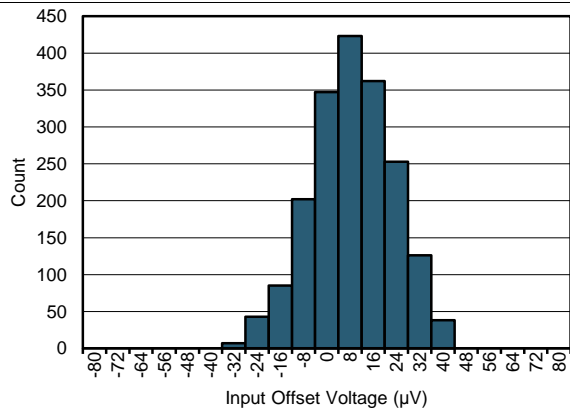

N = 1886  
Std. Dev. = 13.98 µV  
Mean = 4.73 µV

Figure 1. Typical Distribution of Input Offset Voltage

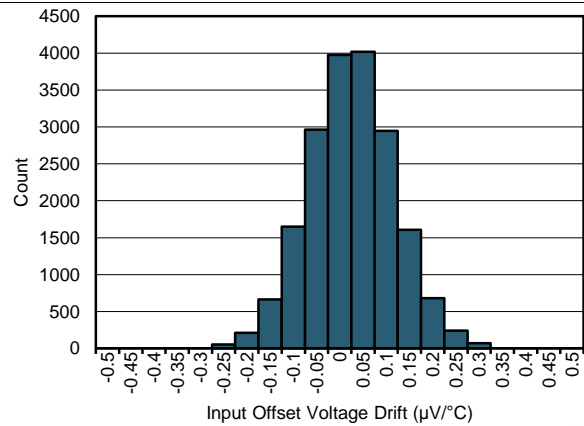

N = 19081  
Std. Dev. = 0.09 µV/°C  
Mean = 0.16 nV/°C

Figure 2. Typical Distribution of Input Offset Voltage Drift

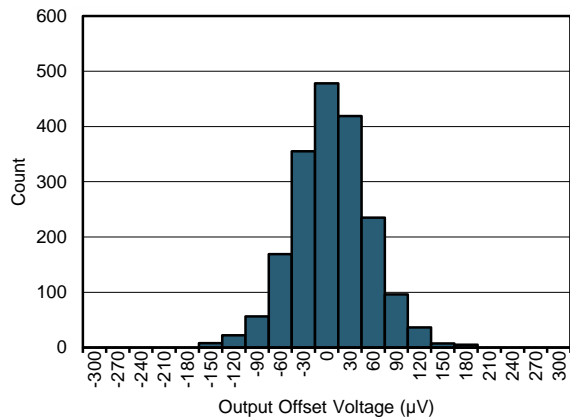

N = 1886  
Std. Dev. = 48.57 µV  
Mean = -8.71 µV

Figure 3. Typical Distribution of Output Offset Voltage

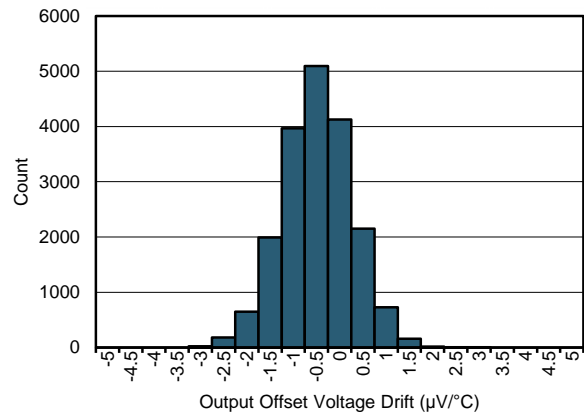

N = 19081  
Std. Dev. = 0.74 µV/°C  
Mean = -0.73 µV/°C

Figure 4. Typical Distribution of Output Offset Voltage Drift

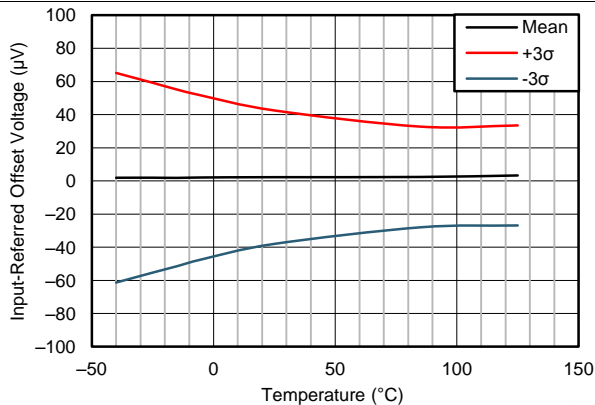

G = 100  
88 units, 3 wafer lots

Figure 5. Input-Referred Offset Voltage vs Temperature

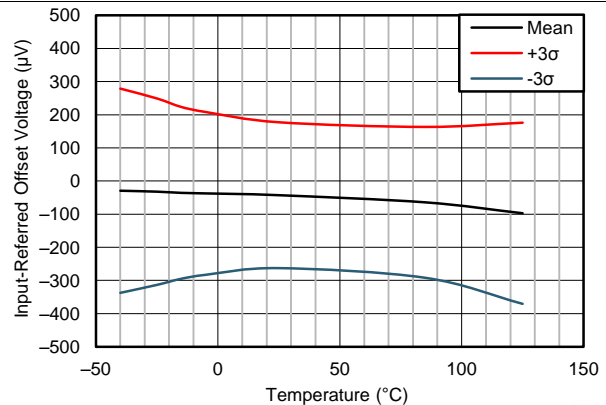

G = 1  
88 units, 3 wafer lots

Figure 6. Input-Referred Offset Voltage vs Temperature

### Typical Characteristics (continued)

At  $T_A = 25^\circ\text{C}$ ,  $V_S = \pm 15\text{ V}$ ,  $R_L = 10\text{ k}\Omega$ ,  $V_{REF} = 0\text{ V}$ , and  $G = 1$  (unless otherwise noted)

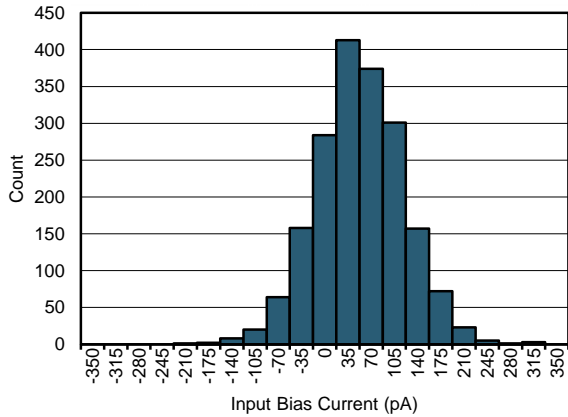

N = 1886  
Std. Dev. = 65.31 pA  
Mean = 36.25 pA

Figure 7. Typical Distribution of Input Bias Current (25°C)

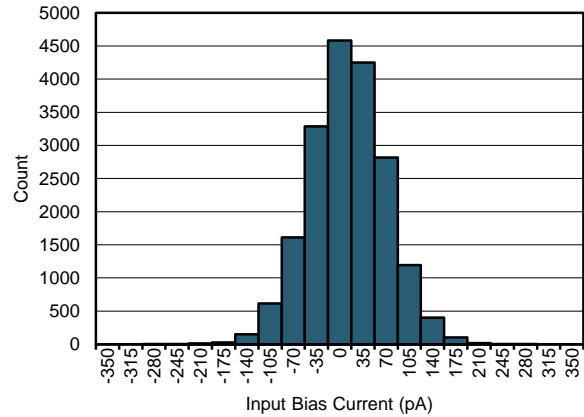

N = 19081  
Std. Dev. = 57.46 pA  
Mean = -5.32 pA

Figure 8. Typical Distribution of Input Bias Current (90°C)

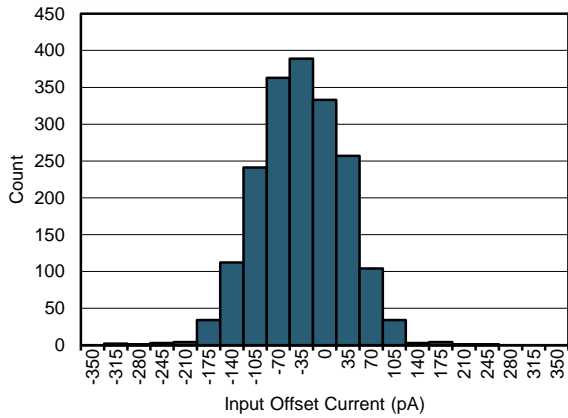

N = 1886  
Std. Dev. = 63.86 pA  
Mean = -52.64 pA

Figure 9. Typical Distribution of Input Offset Current

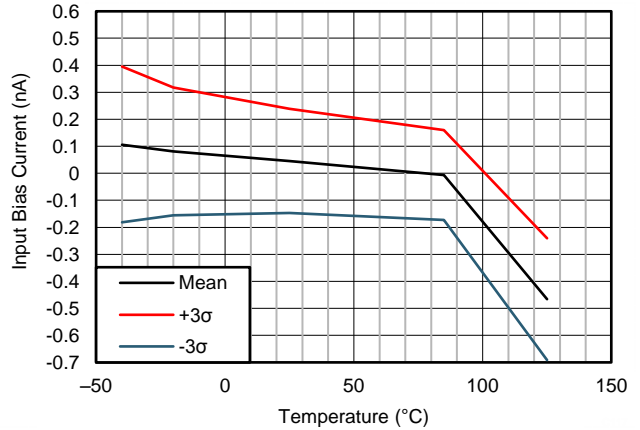

Figure 10. Input Bias Current vs Temperature

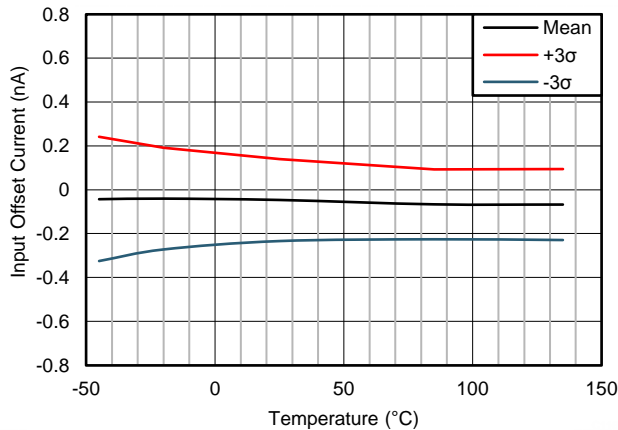
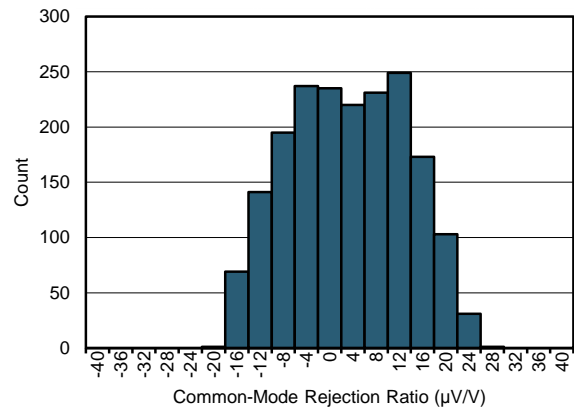

Figure 11. Input Offset Current vs Temperature



N = 1886  
Std. Dev. = 10.04 μV/V  
Mean = 1.18 μV/V

Figure 12. Typical CMRR Distribution (G = 1)



Typical Characteristics (continued)

At  $T_A = 25^\circ\text{C}$ ,  $V_S = \pm 15\text{ V}$ ,  $R_L = 10\text{ k}\Omega$ ,  $V_{REF} = 0\text{ V}$ , and  $G = 1$  (unless otherwise noted)

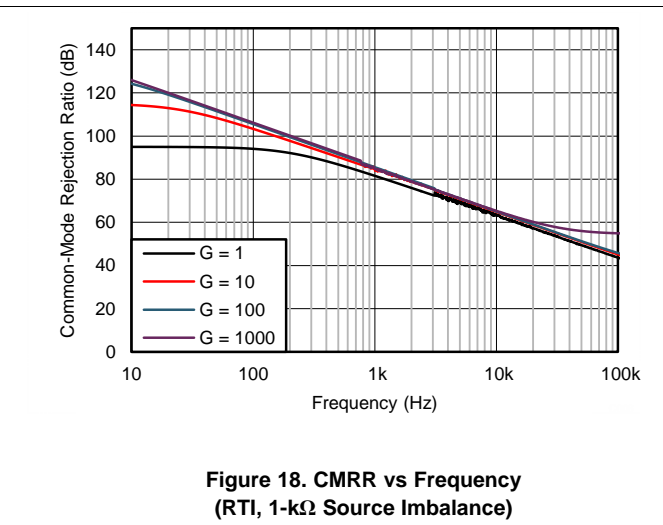
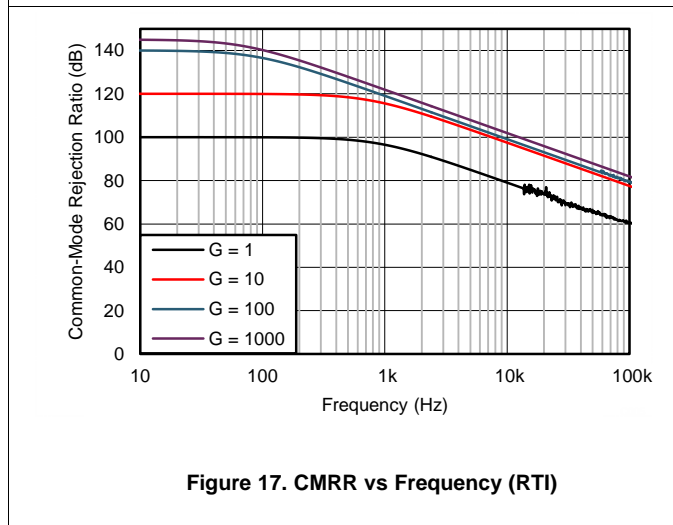
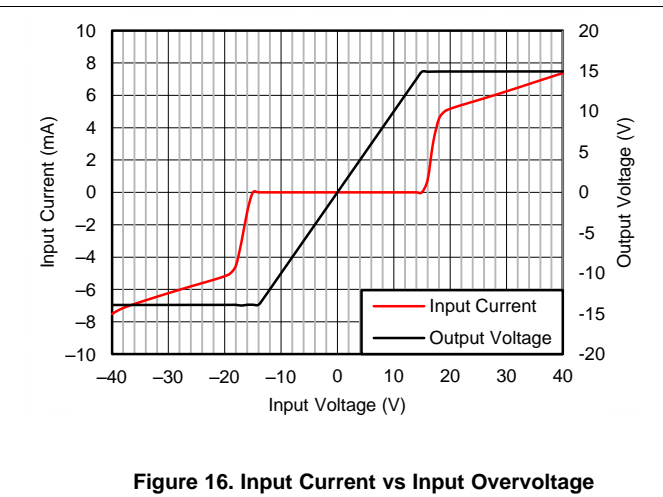
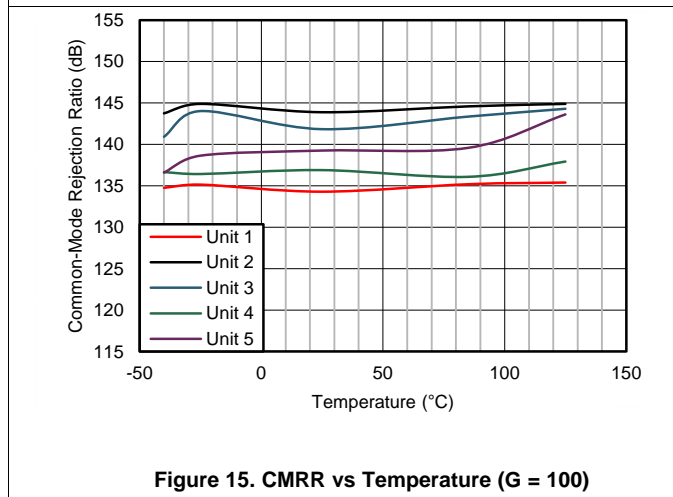
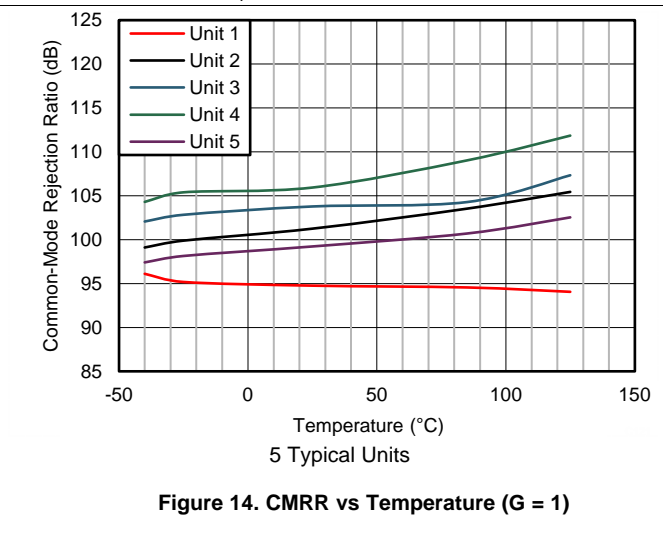
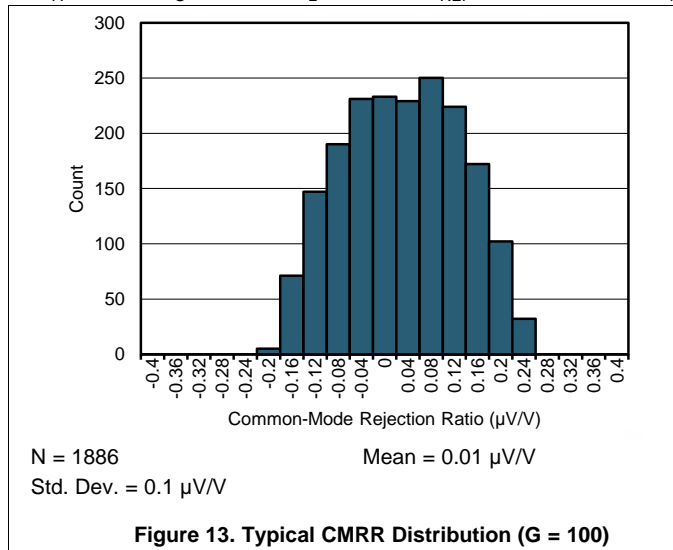

### Typical Characteristics (continued)

At  $T_A = 25^\circ\text{C}$ ,  $V_S = \pm 15\text{ V}$ ,  $R_L = 10\text{ k}\Omega$ ,  $V_{REF} = 0\text{ V}$ , and  $G = 1$  (unless otherwise noted)

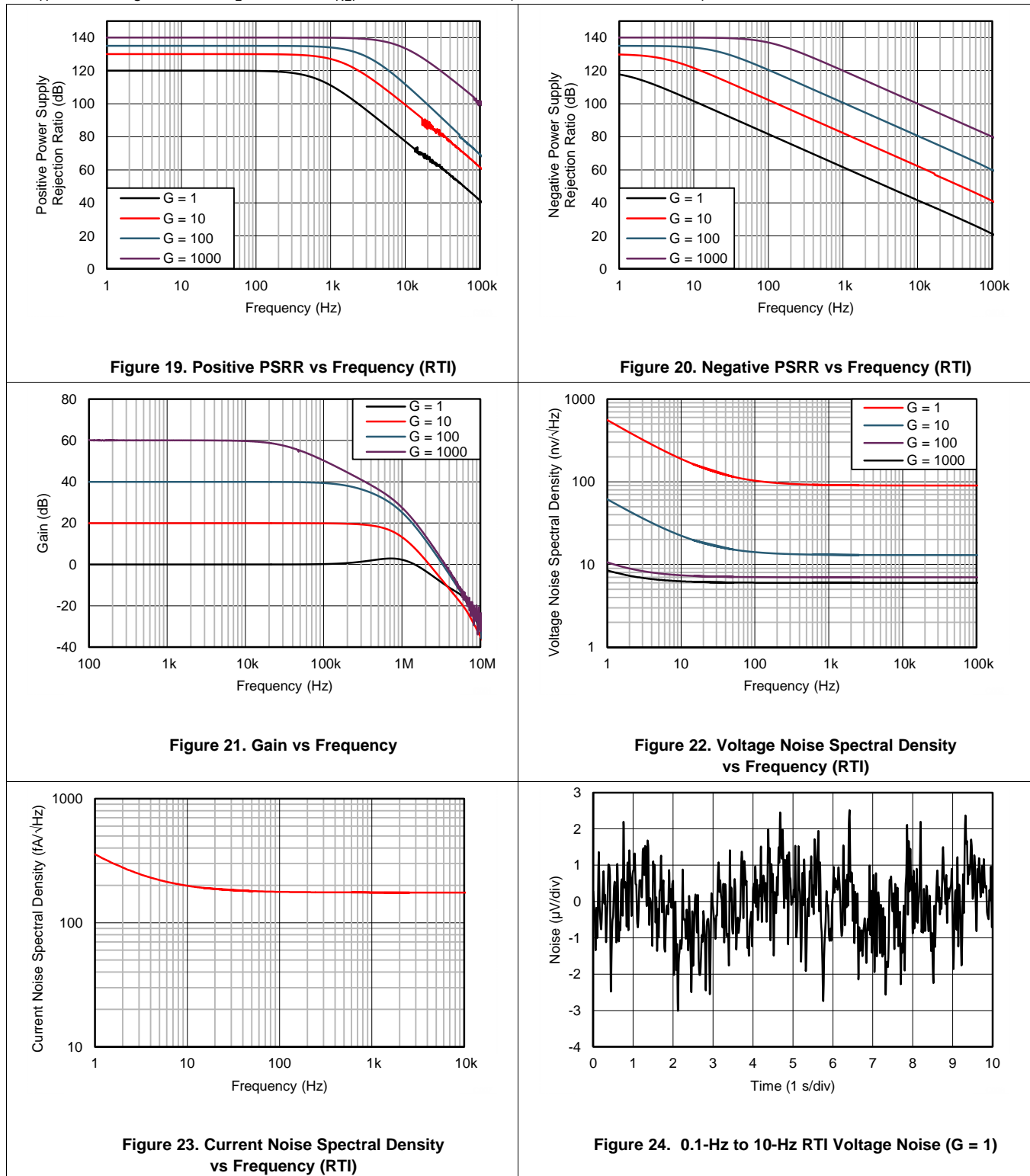

Typical Characteristics (continued)

At  $T_A = 25^\circ\text{C}$ ,  $V_S = \pm 15\text{ V}$ ,  $R_L = 10\text{ k}\Omega$ ,  $V_{REF} = 0\text{ V}$ , and  $G = 1$  (unless otherwise noted)

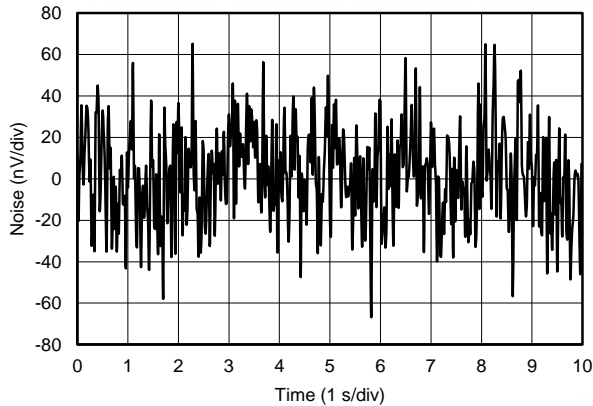

Figure 25. 0.1-Hz to 10-Hz RTI Voltage Noise ( $G = 1000$ )

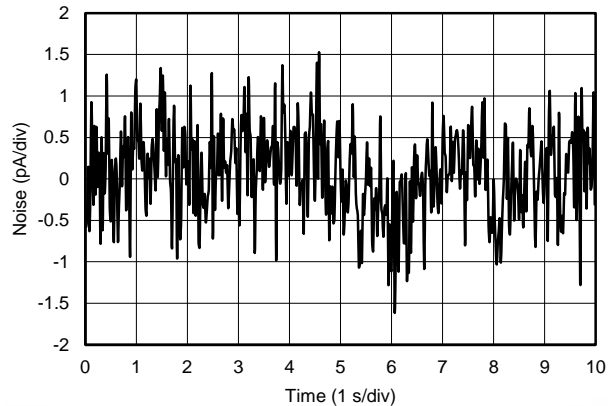

Figure 26. 0.1-Hz to 10-Hz RTI Current Noise

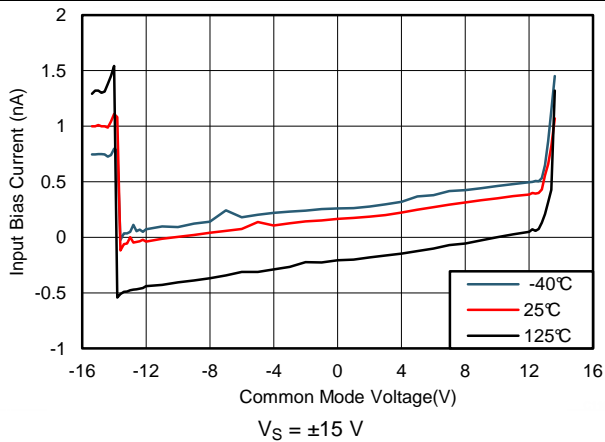

Figure 27. Input Bias Current vs Common-Mode Voltage

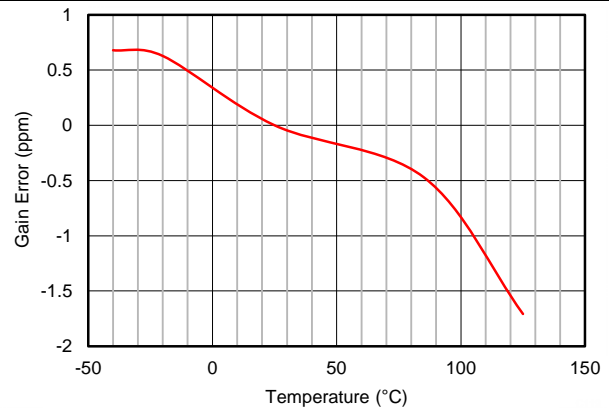

Figure 28. Gain Error vs Temperature ( $G = 1$ )

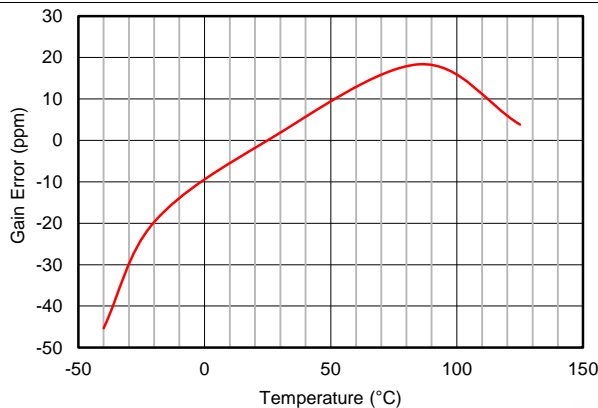

Figure 29. Gain Error vs Temperature ( $G = 100$ )

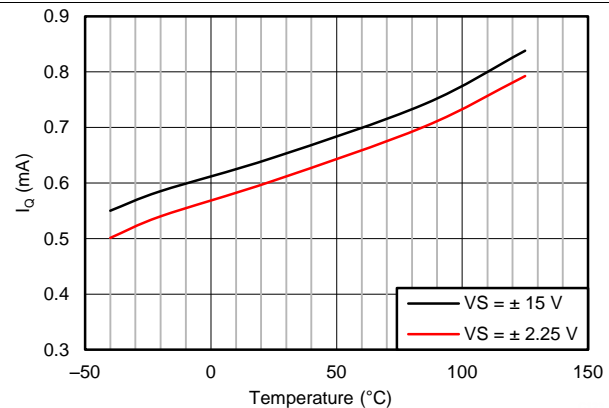

Figure 30. Supply Current vs Temperature

### Typical Characteristics (continued)

At  $T_A = 25^\circ\text{C}$ ,  $V_S = \pm 15\text{ V}$ ,  $R_L = 10\text{ k}\Omega$ ,  $V_{REF} = 0\text{ V}$ , and  $G = 1$  (unless otherwise noted)

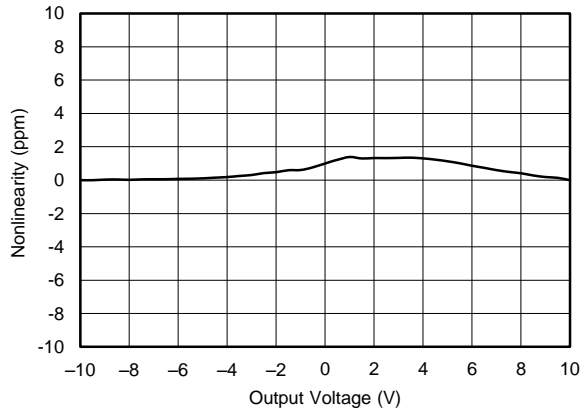

Figure 31. Gain Nonlinearity (G = 1)

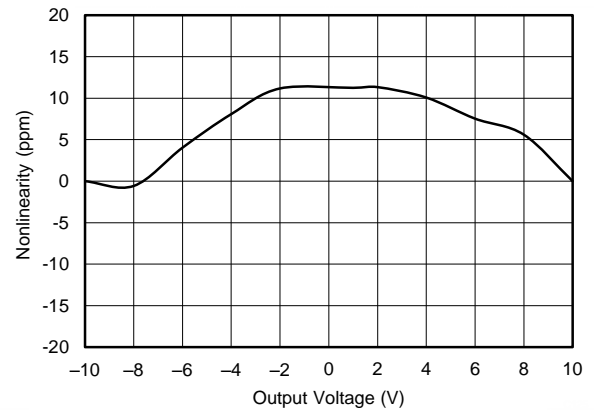

Figure 32. Gain Nonlinearity (G = 100)

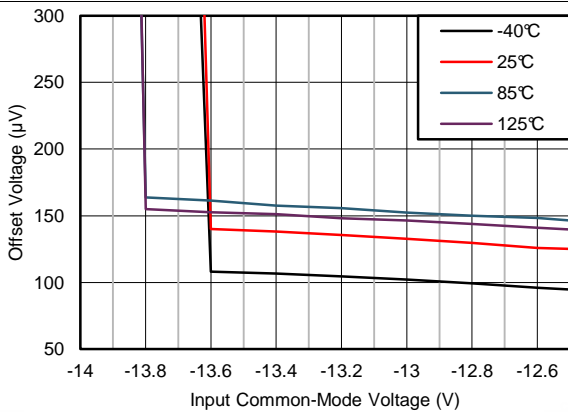

Figure 33. Offset Voltage vs Negative Common-Mode Voltage

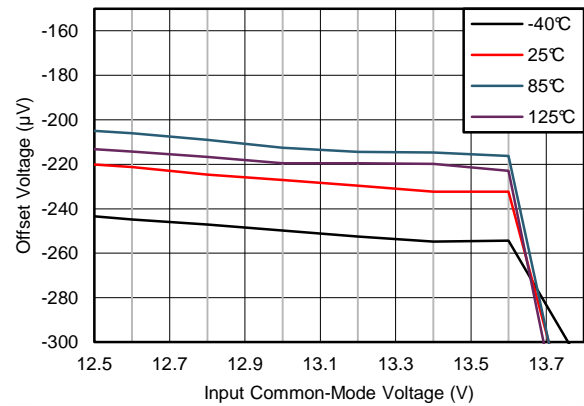

Figure 34. Offset Voltage vs Positive Common-Mode Voltage

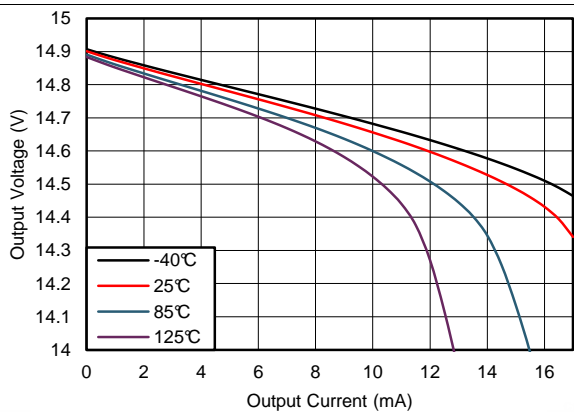

Figure 35. Positive Output Voltage Swing vs Output Current

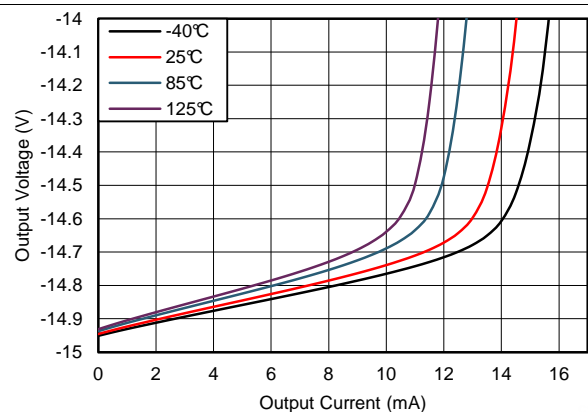

Figure 36. Negative Output Voltage Swing vs Output Current

Typical Characteristics (continued)

At  $T_A = 25^\circ\text{C}$ ,  $V_S = \pm 5\text{ V}$ ,  $R_L = 10\text{ k}\Omega$ ,  $V_{REF} = 0\text{ V}$ , and  $G = 1$  (unless otherwise noted)

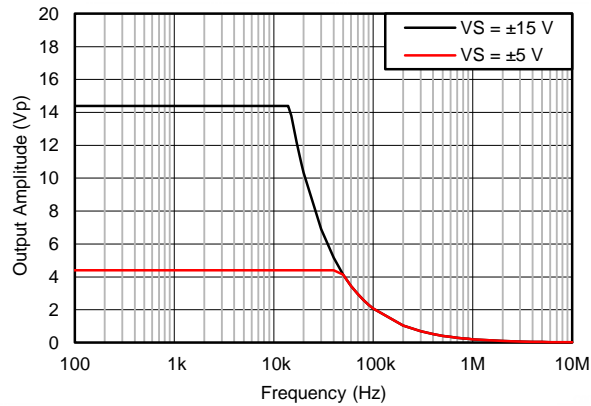
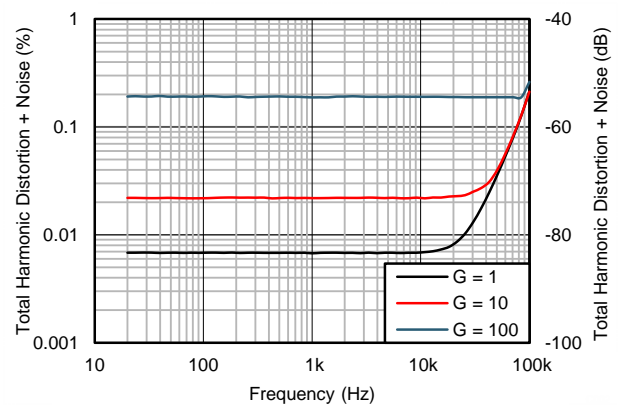

Figure 37. Large-Signal Frequency Response



500-kHz Measurement bandwidth  
1- $V_{RMS}$  Output voltage  
100-k $\Omega$  Load

Figure 38. THD+N vs Frequency

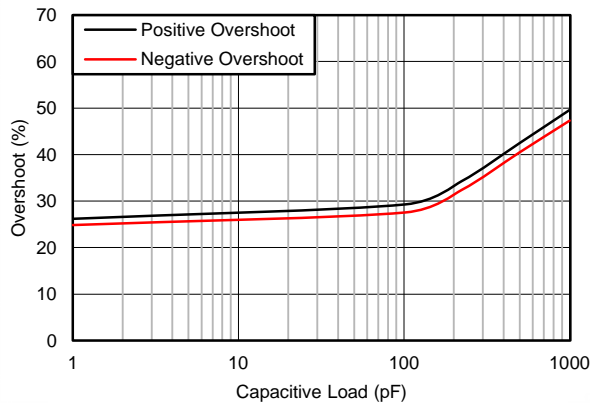
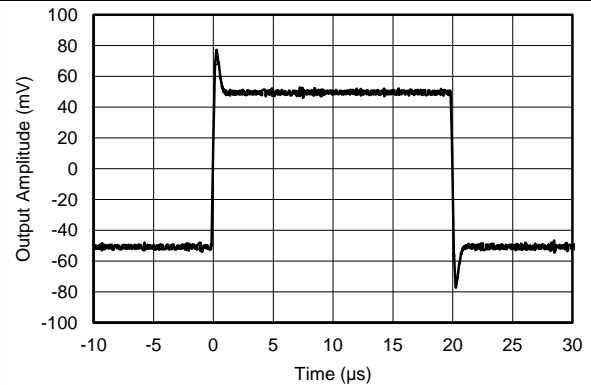
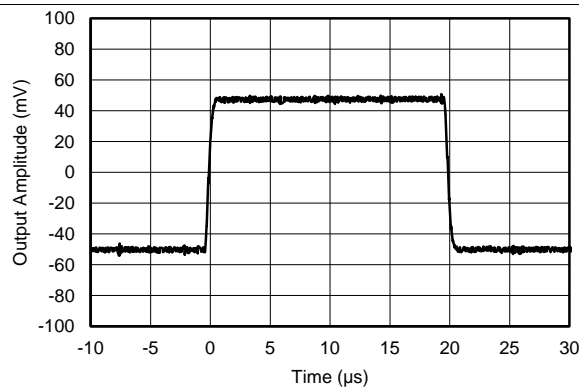

Figure 39. Overshoot vs Capacitive Loads



$G = 1$ ,  $R_L = 10\text{ k}\Omega$ ,  $C_L = 100\text{ pF}$

Figure 40. Small-Signal Response



$G = 10$ ,  $R_L = 10\text{ k}\Omega$ ,  $C_L = 100\text{ pF}$

Figure 41. Small-Signal Response

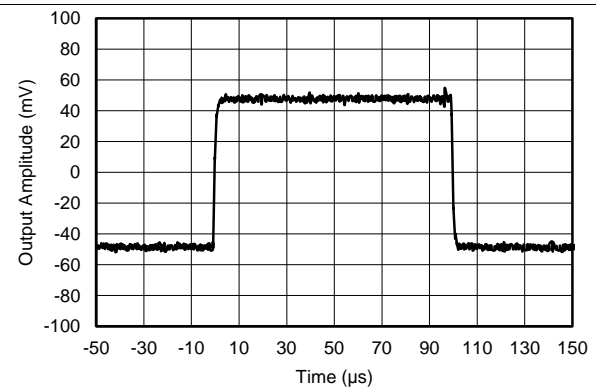

$G = 100$ ,  $R_L = 10\text{ k}\Omega$ ,  $C_L = 100\text{ pF}$

Figure 42. Small-Signal Response

Typical Characteristics (continued)

At  $T_A = 25^\circ\text{C}$ ,  $V_S = \pm 15\text{ V}$ ,  $R_L = 10\text{ k}\Omega$ ,  $V_{REF} = 0\text{ V}$ , and  $G = 1$  (unless otherwise noted)

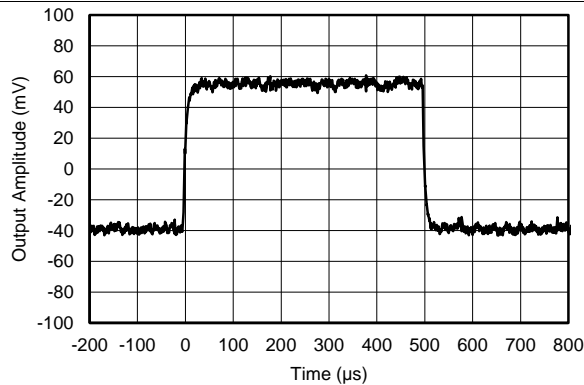

$G = 1000$ ,  $R_L = 10\text{ k}\Omega$ ,  $C_L = 100\text{ pF}$

Figure 43. Small-Signal Response

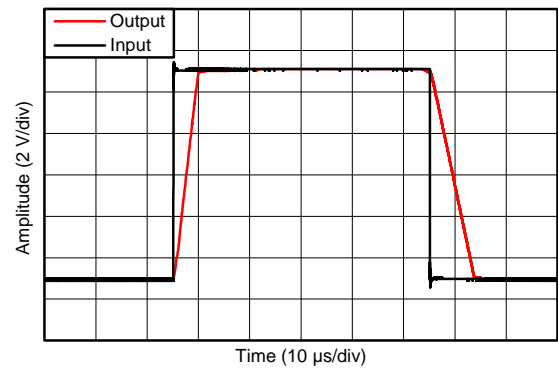

Figure 44. Large Signal Step Response

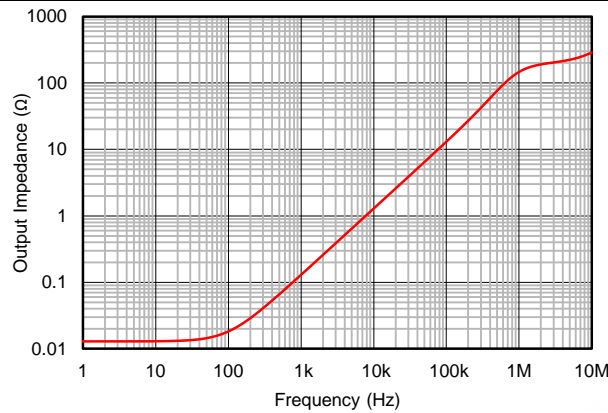

Figure 45. Closed-Loop Output Impedance

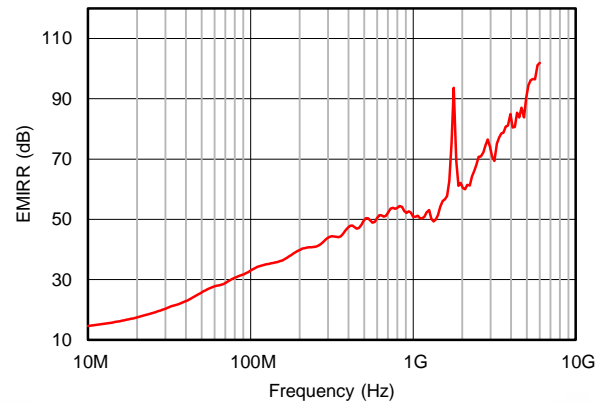

Figure 46. Differential-Mode EMI Rejection Ratio

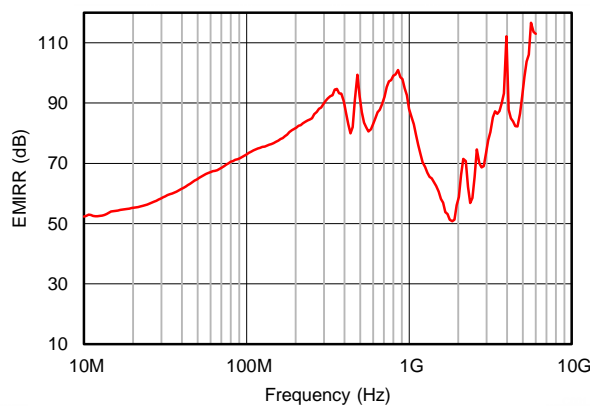

Figure 47. Common-Mode EMI Rejection Ratio

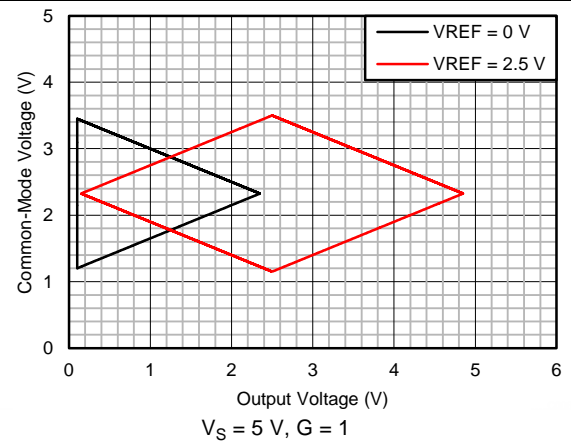

Figure 48. Input Common-Mode Voltage vs Output Voltage  
 $V_S = 5\text{ V}$ ,  $G = 1$

### Typical Characteristics (continued)

At  $T_A = 25^\circ\text{C}$ ,  $V_S = \pm 15\text{ V}$ ,  $R_L = 10\text{ k}\Omega$ ,  $V_{REF} = 0\text{ V}$ , and  $G = 1$  (unless otherwise noted)

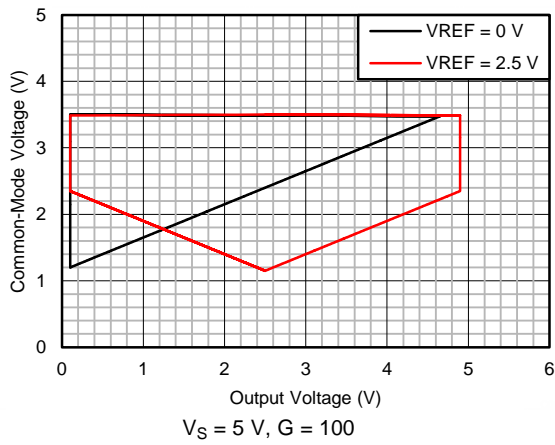

Figure 49. Input Common-Mode Voltage vs Output Voltage

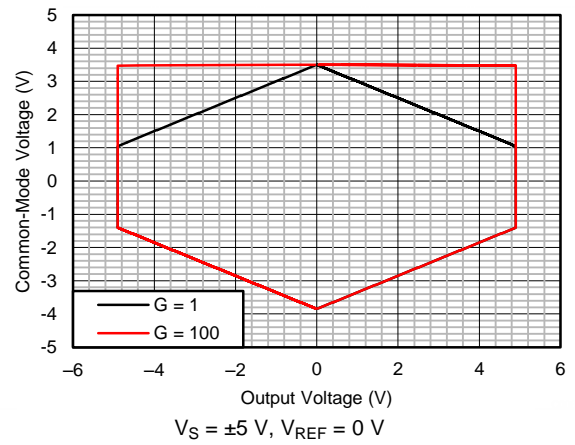

Figure 50. Input Common-Mode Voltage vs Output Voltage

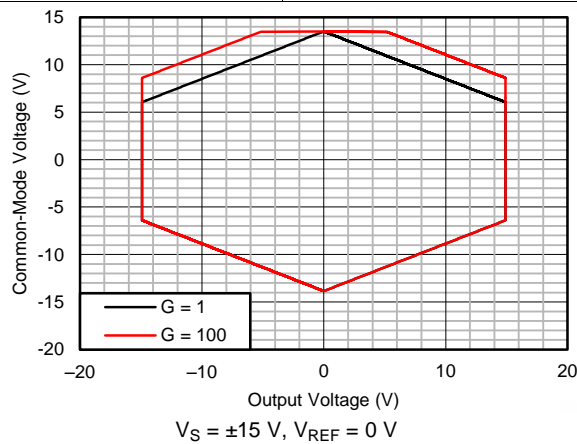

Figure 51. Input Common-Mode Voltage vs Output Voltage

## 7 Detailed Description

### 7.1 Overview

The INA828 is a monolithic precision instrumentation amplifier incorporating a current-feedback input stage and a 4-resistor difference amplifier output stage. The differential input voltage is buffered by  $Q_1$  and  $Q_2$  and is forced across  $R_G$ , which causes a signal current to flow through  $R_G$ ,  $R_1$ , and  $R_2$ . The output difference amplifier,  $A_3$ , removes the common-mode component of the input signal and refers the output signal to the REF terminal. The  $V_{BE}$  and voltage drop across  $R_1$  and  $R_2$  produce output voltages on  $A_1$  and  $A_2$  that are approximately 0.8 V lower than the input voltages.

Each input is protected by two field-effect transistors (FETs) that provide a low series resistance under normal signal conditions, and preserve excellent noise performance. When excessive voltage is applied, these transistors limit input current to approximately 8 mA.

### 7.2 Functional Block Diagram

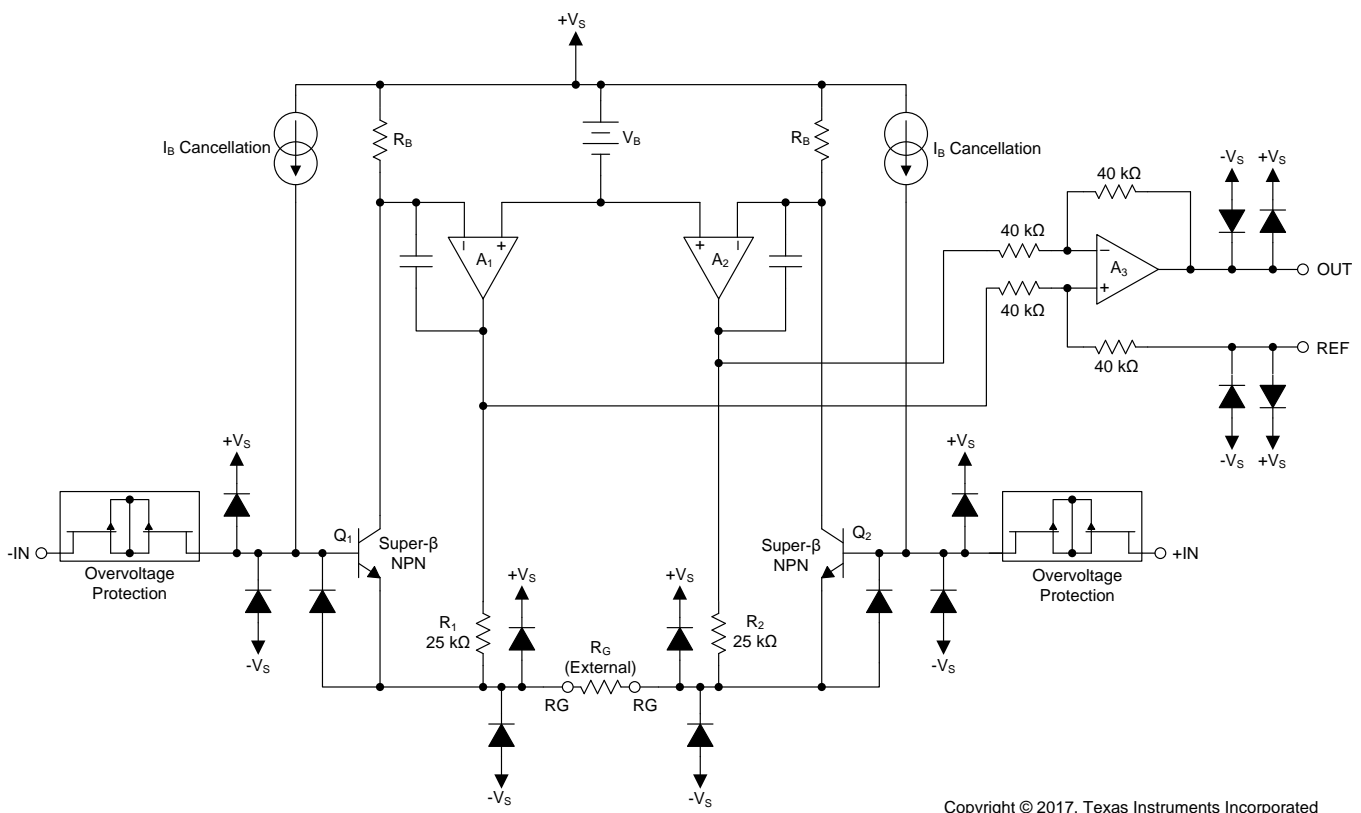

Copyright © 2017, Texas Instruments Incorporated



### 7.3 Feature Description

#### 7.3.1 Setting the Gain

Figure 52 shows that the gain of the INA828 is set by a single external resistor,  $R_G$ , connected between the  $R_G$  pins (pins 1 and 8).

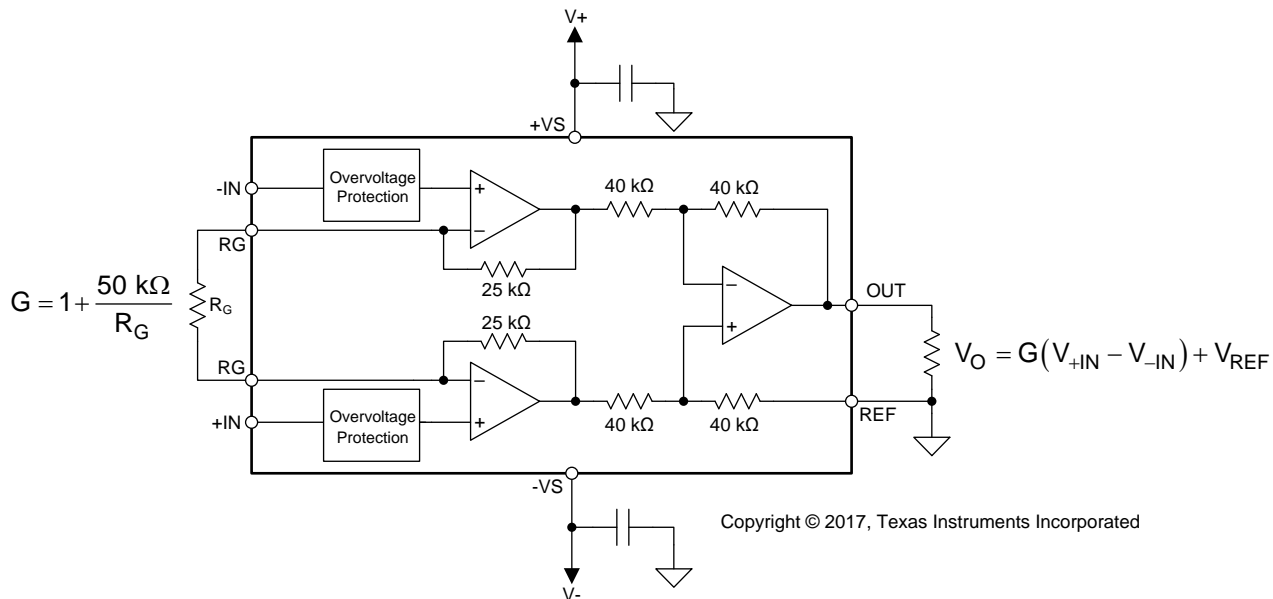

Figure 52. Simplified Diagram of the INA828 With Gain and Output Equations

The value of  $R_G$  is selected according to:

$$G = 1 + \frac{50 \text{ k}\Omega}{R_G} \tag{1}$$

Table 1 lists several commonly-used gains and resistor values. The 50-k $\Omega$  term in Equation 1 comes from the sum of the two internal 25-k $\Omega$  feedback resistors. These on-chip resistors are laser-trimmed to accurate absolute values. The accuracy and temperature coefficients of these resistors are included in the gain accuracy and drift specifications of the INA828.

Table 1. Commonly-Used Gains and Resistor Values

DESIRED GAIN	$R_G$ ( $\Omega$ )	NEAREST 1% $R_G$ ( $\Omega$ )
1	NC	NC
2	50 k	49.9 k
5	12.5 k	12.4 k
10	5.556 k	5.49 k
20	2.632 k	2.61 k
50	1.02 k	1.02 k
100	505.1	511
200	251.3	249
500	100.2	100
1000	50.05	49.9

### 7.3.1.1 Gain Drift

The stability and temperature drift of the external gain setting resistor,  $R_G$ , also affects gain. The contribution of  $R_G$  to gain accuracy and drift can be determined from [Equation 1](#).

The best gain drift of 5 ppm/°C (maximum) can be achieved when the INA828 uses  $G = 1$  without  $R_G$  connected. In this case, gain drift is limited only by the slight mismatch of the temperature coefficient of the integrated 40-k $\Omega$  resistors in the differential amplifier ( $A_3$ ). At gains greater than 1, gain drift increases as a result of the individual drift of the 25-k $\Omega$  resistors in the feedback of  $A_1$  and  $A_2$ , relative to the drift of the external gain resistor  $R_G$ . The low temperature coefficient of the internal feedback resistors significantly improves the overall temperature stability of applications using gains greater than 1 V/V over alternate solutions.

Low resistor values required for high gain can make wiring resistance important. Sockets add to the wiring resistance and contribute additional gain error (such as a possible unstable gain error) at gains of approximately 100 or greater. To assure stability, avoid parasitic capacitance of more than a few picofarads at  $R_G$  connections. Careful matching of any parasitics on both  $R_G$  pins maintains optimal CMRR over frequency; see *Typical Characteristics*, [Figure 17](#).

### 7.3.2 EMI Rejection

Texas Instruments developed a method to accurately measure the immunity of an amplifier over a broad frequency spectrum, extending from 10 MHz to 6 GHz. This method uses an EMI rejection ratio (EMIRR) to quantify the ability of the INA828 to reject EMI. The offset resulting from an input EMI signal can be calculated using [Equation 2](#):

$$\Delta V_{OS} = \left( \frac{V_{RF\_PEAK}^2}{100 \text{ mV}_P} \right) \cdot 10^{-\left( \frac{\text{EMIRR (dB)}}{20} \right)}$$

where

- $V_{RF\_PEAK}$  is the peak amplitude of the input EMI signal. (2)

[Figure 53](#) and [Figure 54](#) show the INA828 EMIRR graph for both differential and common-mode EMI rejection across this frequency range. [Table 2](#) shows the EMIRR values for the INA828 at frequencies commonly encountered in real-world applications. Applications listed in [Table 2](#) can be centered on or operated near the particular frequency shown. Depending on the end-system requirements, additional EMI filters may be required near the signal inputs of the system, as well as incorporating known good practices such as using short traces, low-pass filters, and damping resistors combined with parallel and shielded signal routing.

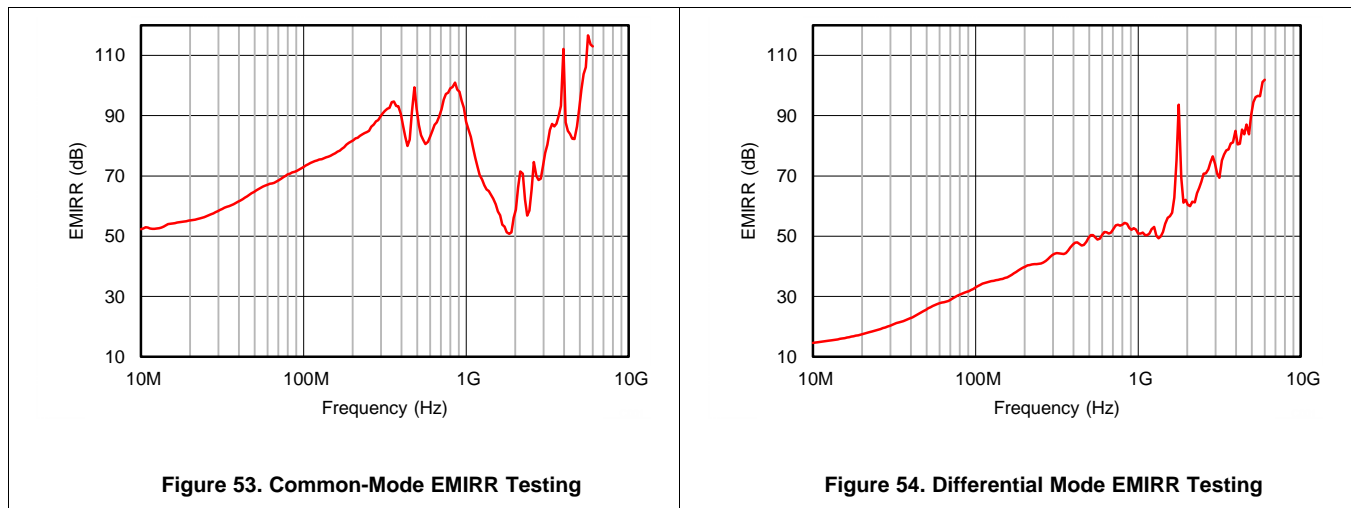
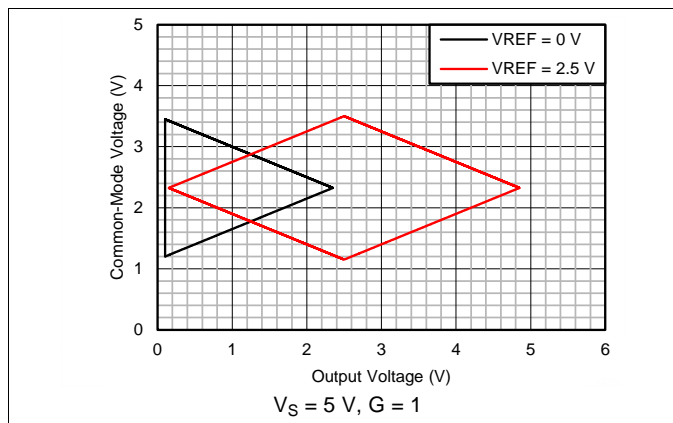

**Table 2. INA828 EMIRR for Frequencies of Interest**

FREQUENCY	APPLICATION OR ALLOCATION	DIFFERENTIAL EMIRR	COMMON-MODE EMIRR
400 MHz	Mobile radio, mobile satellite, space operation, weather, radar, ultrahigh-frequency (UHF) applications	48 dB	87 dB
900 MHz	Global system for mobile communications (GSM) applications, radio communication, navigation, GPS (up to 1.6 GHz), GSM, aeronautical mobile, UHF applications	52 dB	98 dB
1.8 GHz	GSM applications, mobile personal communications, broadband, satellite, L-band (1 GHz to 2 GHz)	94 dB	51 dB
2.4 GHz	802.11b, 802.11g, 802.11n, Bluetooth®, mobile personal communications, industrial, scientific and medical (ISM) radio band, amateur radio and satellite, S-band (2 GHz to 4 GHz)	66 dB	57 dB
3.6 GHz	Radiolocation, aero communication and navigation, satellite, mobile, S-band	79 dB	87 dB
5 GHz	802.11a, 802.11n, aero communication and navigation, mobile communication, space and satellite operation, C-band (4 GHz to 8 GHz)	90 dB	92 dB

**7.3.3 Input Common-Mode Range**

The linear input voltage range of the INA828 input circuitry extends within 2 Volts of both power supplies and maintains excellent common-mode rejection throughout this range. The common-mode range for the most common operating conditions are shown in Figure 55, Figure 50, and Figure 51. The common-mode range for other operating conditions is best calculated using the *INA common-mode range calculating tool*. The INA828 device can operate over a wide range of power supplies and VREF configurations, thus providing a comprehensive guide to common-mode range limits for all possible conditions is impractical.



**Figure 55. Input Common-Mode Voltage vs Output Voltage**

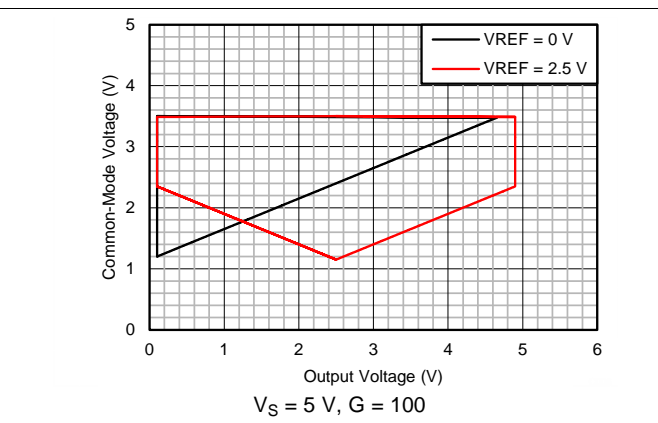

**Figure 56. Input Common-Mode Voltage vs Output Voltage**

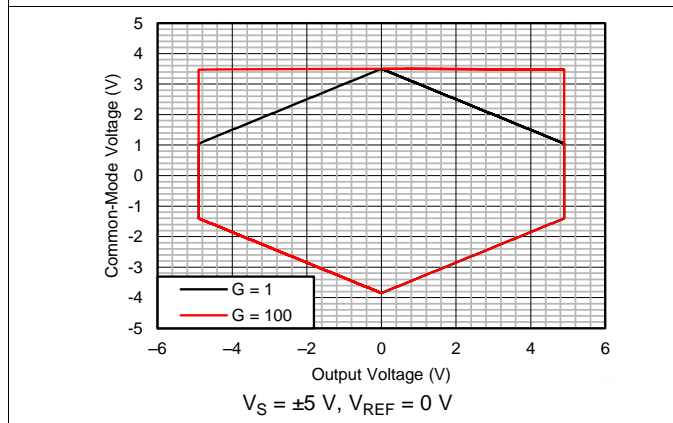

**Figure 57. Input Common-Mode Voltage vs Output Voltage**

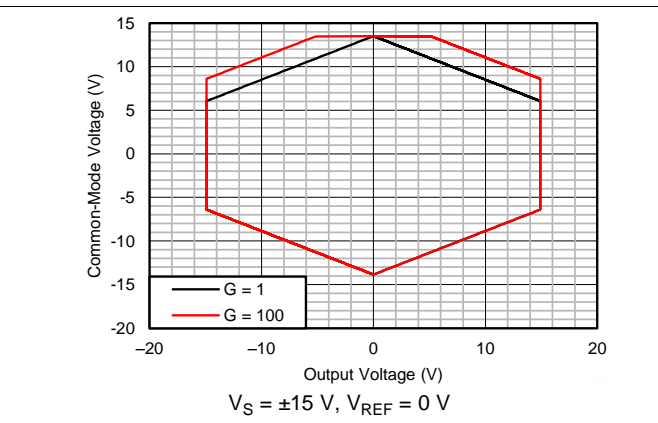

**Figure 58. Input Common-Mode Voltage vs Output Voltage**

### 7.3.4 Input Protection

The inputs of the INA828 device are individually protected for voltages up to  $\pm 40$  V. For example, a condition of  $-40$  V on one input and  $40$  V on the other input does not cause damage. Internal circuitry on each input provides low series impedance under normal signal conditions. If the input is overloaded, the protection circuitry limits the input current to a value of approximately  $8$  mA.

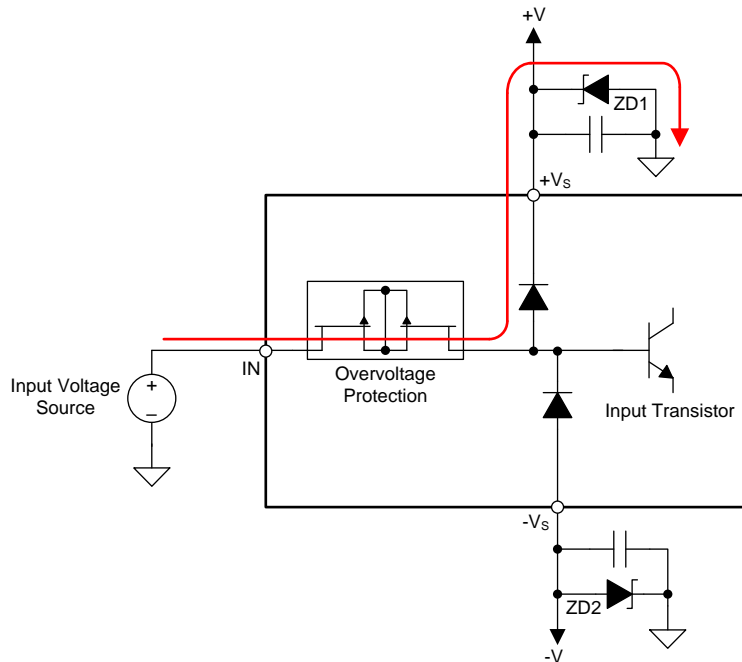

Figure 59. Input Current Path During an Overvoltage Condition

During an input overvoltage condition, current flows through the input protection diodes into the power supplies, see Figure 59. If the power supplies are unable to sink current, then Zener diode clamps (ZD1 and ZD2 in Figure 59) must be placed on the power supplies to provide a current pathway to ground. Figure 60 illustrates the input current for input voltages from  $-40$  V to  $+40$  V when the INA828 is powered by  $\pm 15$ -V supplies.

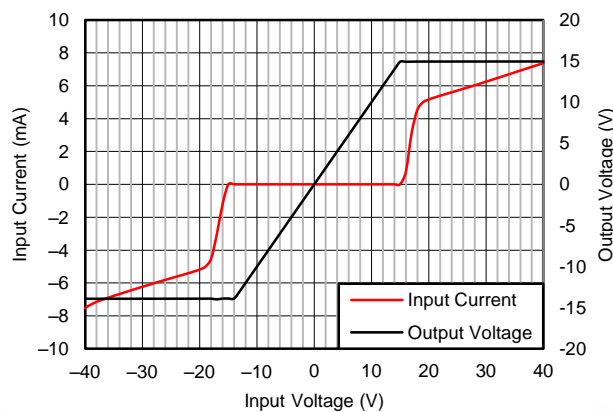

Figure 60. Input Current vs Input Overvoltage

### 7.3.5 Operating Voltage

The INA828 operates over a power-supply range of 4.5 V to 36 V ( $\pm 2.25$  V to  $\pm 18$  V).

#### CAUTION

Supply voltages higher than 40 V ( $\pm 20$  V) can permanently damage the device. Parameters that vary over supply voltage or temperature are shown in the *Typical Characteristics* section of this data sheet.

### 7.4 Device Functional Modes

The INA828 has a single functional mode and is operational when the power-supply voltage is greater than 4.5 V ( $\pm 2.25$  V). The maximum power-supply voltage for the INA828 is 36 V ( $\pm 18$  V).

## 8 Application and Implementation

### NOTE

Information in the following applications sections is not part of the TI component specification, and TI does not warrant its accuracy or completeness. TI's customers are responsible for determining suitability of components for their purposes. Customers should validate and test their design implementation to confirm system functionality.

### 8.1 Reference Terminal

The output voltage of the INA828 is developed with respect to the voltage on the reference terminal, REF. Often, in dual-supply operation, the reference pin (pin 6) is connected to the low-impedance system ground. In single-supply operation, offsetting the output signal to a precise mid-supply level is useful (for example, 2.5 V in a 5-V supply environment). To accomplish this level shift, a voltage source must be connected to the REF pin to level-shift the output so that the INA828 can drive a single-supply ADC.

The voltage source applied to the reference terminal must have a low output impedance. As illustrated in [Figure 61](#), any resistance at the reference terminal (shown as  $R_{REF}$  in [Figure 61](#)) is in series with one of the internal 40-k $\Omega$  resistors.

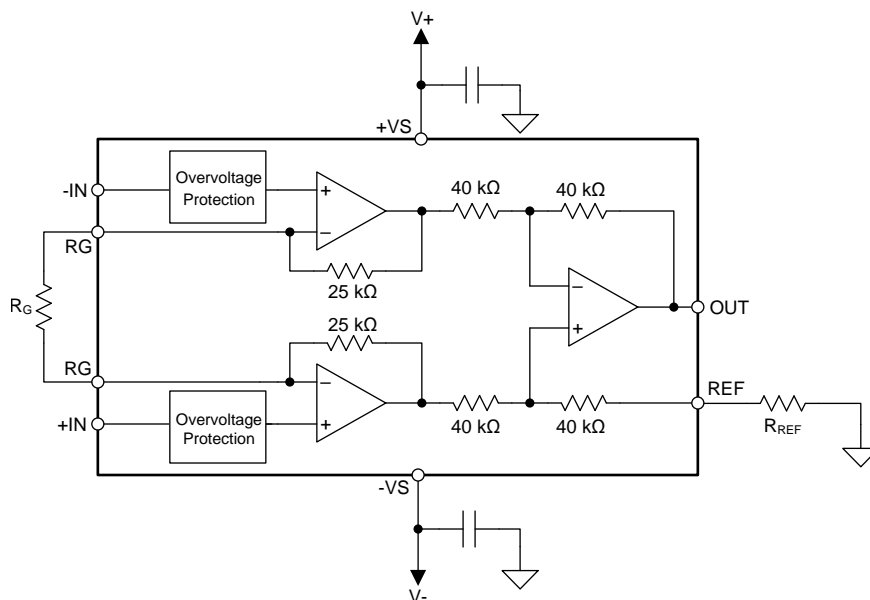

**Figure 61. Parasitic Resistance Shown at the Reference Terminal**

The parasitic resistance at the reference terminal,  $R_{REF}$ , creates an imbalance in the 4 resistors of the internal difference amplifier, resulting in degraded common-mode rejection ratio (CMRR). [Figure 62](#) shows the degradation in CMRR of the INA828 for increasing resistance at the reference terminal. For the best performance, keep the source impedance to the REF terminal,  $R_{REF}$ , below 5  $\Omega$ .

Reference Terminal (continued)

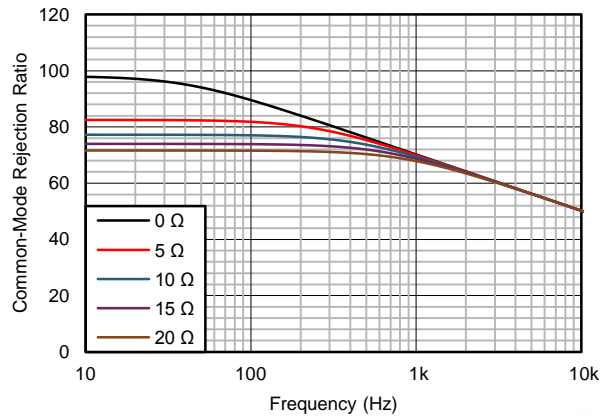
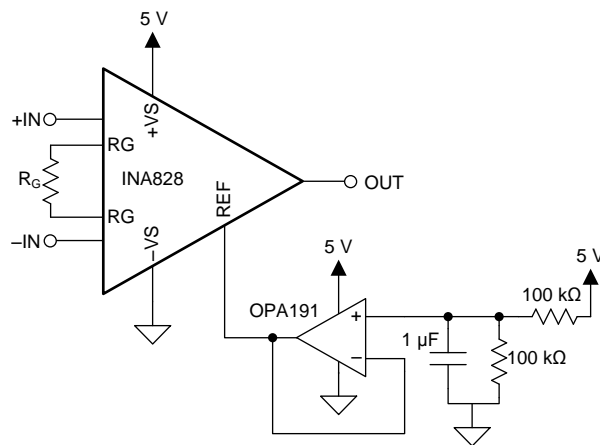

Figure 62. The Effect of Increasing Resistance at the Reference Terminal

Voltage reference ICs are an excellent option for providing a low-impedance voltage source for the reference terminal. However, if a resistor voltage divider is used to generate a reference voltage, it must be buffered by an op amp as shown in Figure 63 to avoid CMRR degradation.



Copyright © 2017, Texas Instruments Incorporated

Figure 63. Using an Op Amp to Buffer Reference Voltages

## 8.2 Input Bias Current Return Path

The input impedance of the INA828 is extremely high—approximately 100 GΩ. However, a path must be provided for the input bias current of both inputs. This input bias current is typically 150 pA. High input impedance means that this input bias current changes very little with varying input voltage.

Input circuitry must provide a path for this input bias current for proper operation. [Figure 64](#) shows various provisions for an input bias current path. Without a bias current path, the inputs float to a potential that exceeds the common-mode range of the INA828, and the input amplifiers saturate. If the differential source resistance is low, the bias current return path can be connected to one input (as shown in the thermocouple example in [Figure 64](#)). With a higher source impedance, using two equal resistors provides a balanced input with possible advantages of a lower input offset voltage as a result of bias current and better high-frequency common-mode rejection.

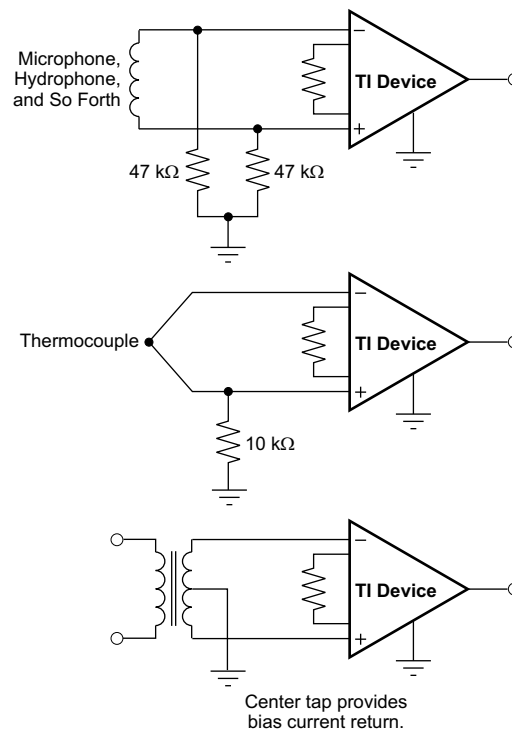

Copyright © 2017, Texas Instruments Incorporated

**Figure 64. Providing an Input Common-Mode Current Path**



### 8.3 PCB Assembly Effects on Precision

The printed-circuit board (PCB) assembly process, including reflow soldering, imparts thermal stresses on the INA828 which can degrade the precision of the device and must be considered in the development of very-high-precision systems. Baking the PCBs after the assembly process can restore the precision of the device to pre-assembly values. Figure 65, Figure 66, and Figure 67 illustrate the effect of reflow soldering on the typical distribution of input offset voltage of the INA828. Figure 65 shows the distribution of input offset voltage for a set of INA828 devices prior to the PCB assembly process. Exposing the INA828 to a JEDEC-standard thermal profile for reflow soldering produces the histogram shown in Figure 66 on another set of INA828 devices. The standard deviation of input offset voltage has almost doubled due to the thermal stress imparted to the INA828 from the reflow process. However, baking INA828 units for 30 minutes at 125°C after the reflow soldering process produced the distribution given in Figure 67. The post-reflow bake restored the standard deviation of the input offset voltage to pre-assembly levels.

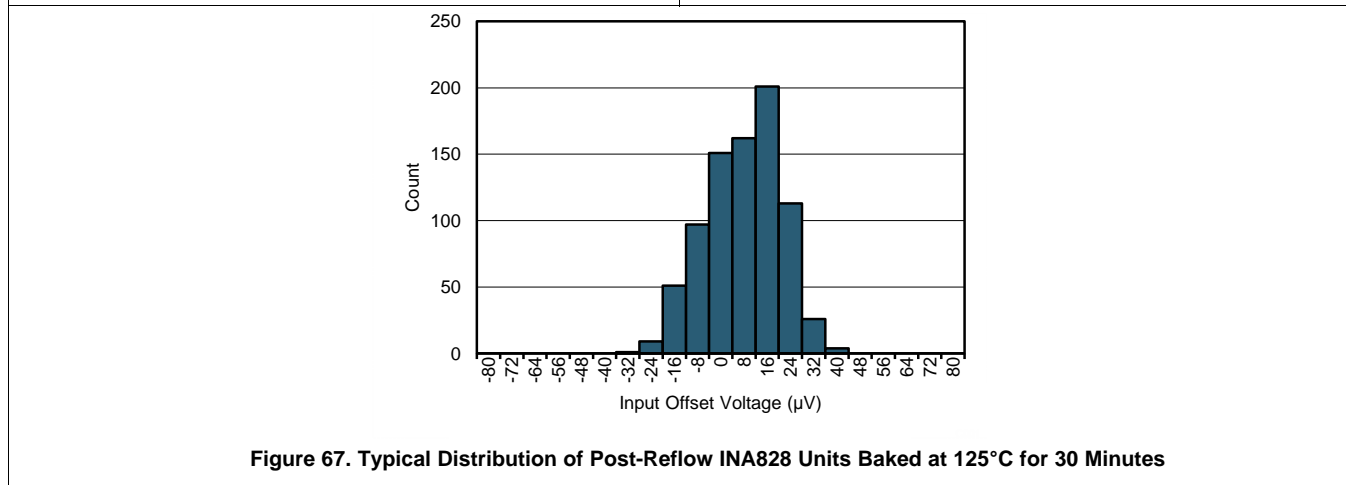
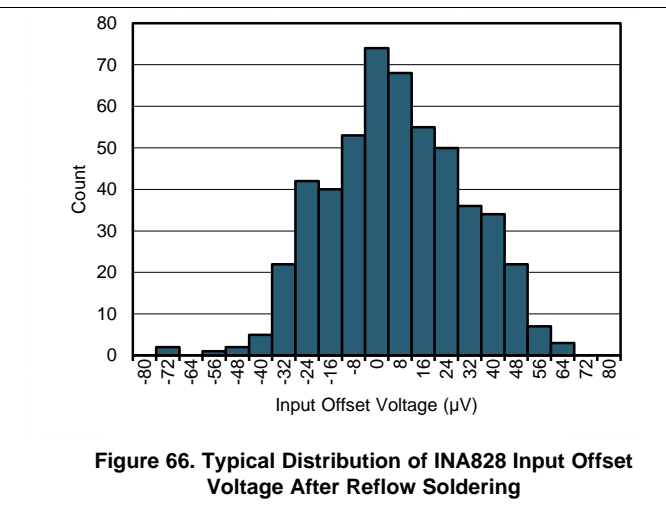
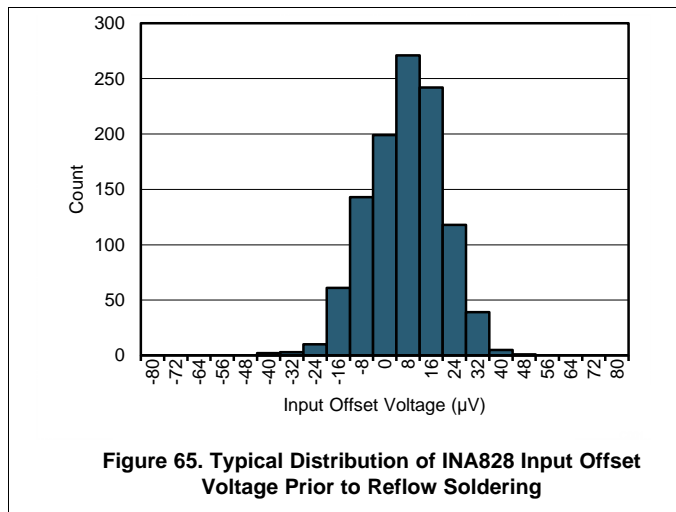

## 8.4 Typical Application

Figure 68 shows a three-terminal programmable-logic controller (PLC) design for the INA828. This PLC reference design accepts inputs of  $\pm 10$  V or  $\pm 20$  mA. The output is a single-ended voltage of  $2.5$  V  $\pm 2.3$  V (or 200 mV to 4.8 V). Many PLCs typically have these input and output ranges.

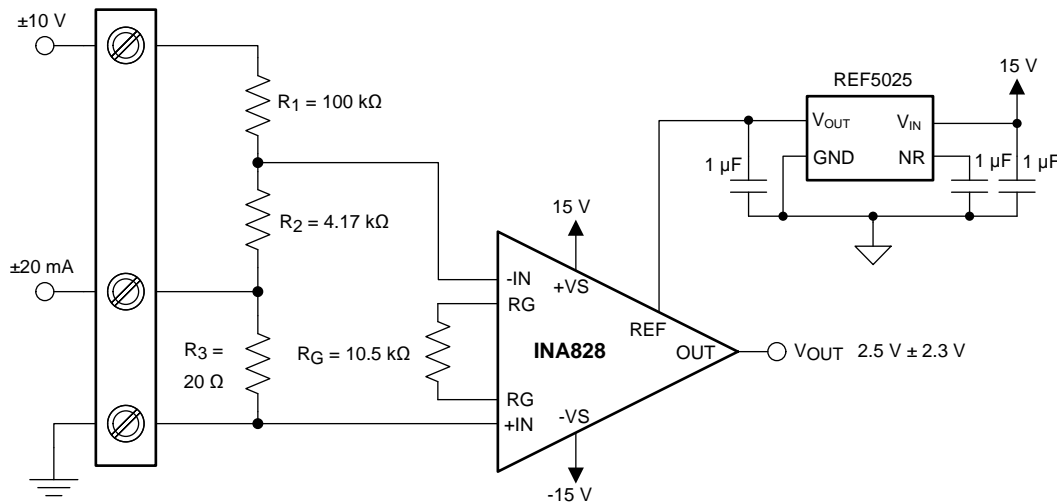

Copyright © 2017, Texas Instruments Incorporated

**Figure 68. PLC Input ( $\pm 10$  V, 4 mA to 20 mA)**

### 8.4.1 Design Requirements

For this application, the design requirements are:

- 4-mA to 20-mA input with less than 20- $\Omega$  burden
- $\pm 20$ -mA input with less than 20- $\Omega$  burden
- $\pm 10$ -V input with impedance of approximately 100 k $\Omega$
- Maximum 4-mA to 20-mA or  $\pm 20$ -mA burden voltage equal to  $\pm 0.4$  V
- Output range within 0 V to 5 V

### 8.4.2 Detailed Design Procedure

There are two modes of operation for the circuit shown in Figure 68: current input and voltage input. This design requires  $R_1 \gg R_2 \gg R_3$ . Given this relationship, Equation 3 calculates the current input mode transfer function.

$$V_{\text{OUT-I}} = V_{\text{D}} \times G + V_{\text{REF}} = -(I_{\text{IN}} \times R_3) \times G + V_{\text{REF}}$$

where

- G represents the gain of the instrumentation amplifier
- $V_{\text{D}}$  represents the differential voltage at the INA828 inputs
- $V_{\text{REF}}$  is the voltage at the INA828 REF pin
- $I_{\text{IN}}$  is the input current

(3)

Equation 4 shows the transfer function for the voltage input mode.

$$V_{\text{OUT-V}} = V_{\text{D}} \times G + V_{\text{REF}} = -\left[ V_{\text{IN}} \times \frac{R_2}{R_1 + R_2} \right] \times G + V_{\text{REF}}$$

where

- $V_{\text{IN}}$  is the input voltage

(4)

$R_1$  sets the input impedance of the voltage input mode. The minimum typical input impedance is 100 k $\Omega$ . 100 k $\Omega$  is selected for  $R_1$  because increasing the  $R_1$  value also increases noise. The value of  $R_3$  must be extremely small compared to  $R_1$  and  $R_2$ . 20  $\Omega$  for  $R_3$  is selected because that resistance value is much smaller than  $R_1$  and yields an input voltage of  $\pm 400$  mV when operated in current mode ( $\pm 20$  mA).

### Typical Application (continued)

Use [Equation 5](#) to calculate  $R_2$  given  $V_D = \pm 400$  mV,  $V_{IN} = \pm 10$  V, and  $R_1 = 100$  k $\Omega$ .

$$V_D = V_{IN} \times \frac{R_2}{R_1 + R_2} \rightarrow R_2 = \frac{R_1 \times V_D}{V_{IN} - V_D} = 4.167 \text{ k}\Omega \quad (5)$$

The value obtained from [Equation 5](#) is not a standard 0.1% value, so 4.17 k $\Omega$  is selected.  $R_1$  and  $R_2$  also use 0.1% tolerance resistors to minimize error.

Use [Equation 6](#) to calculate the ideal gain of the instrumentation amplifier.

$$G = \frac{V_{OUT} - V_{REF}}{V_D} = \frac{4.8 \text{ V} - 2.5 \text{ V}}{400 \text{ mV}} = 5.75 \frac{\text{V}}{\text{V}} \quad (6)$$

[Equation 7](#) calculates the gain-setting resistor value using the INA828 gain equation, [Equation 1](#).

$$R_G = \frac{50 \text{ k}\Omega}{G - 1} = \frac{50 \text{ k}\Omega}{5.75 - 1} = 10.5 \text{ k}\Omega \quad (7)$$

10.5 k $\Omega$  is a standard 0.1% resistor value that can be used in this design.

### 8.4.3 Application Curves

[Figure 69](#) and [Figure 70](#) show typical characteristic curves for the circuit in [Figure 68](#).

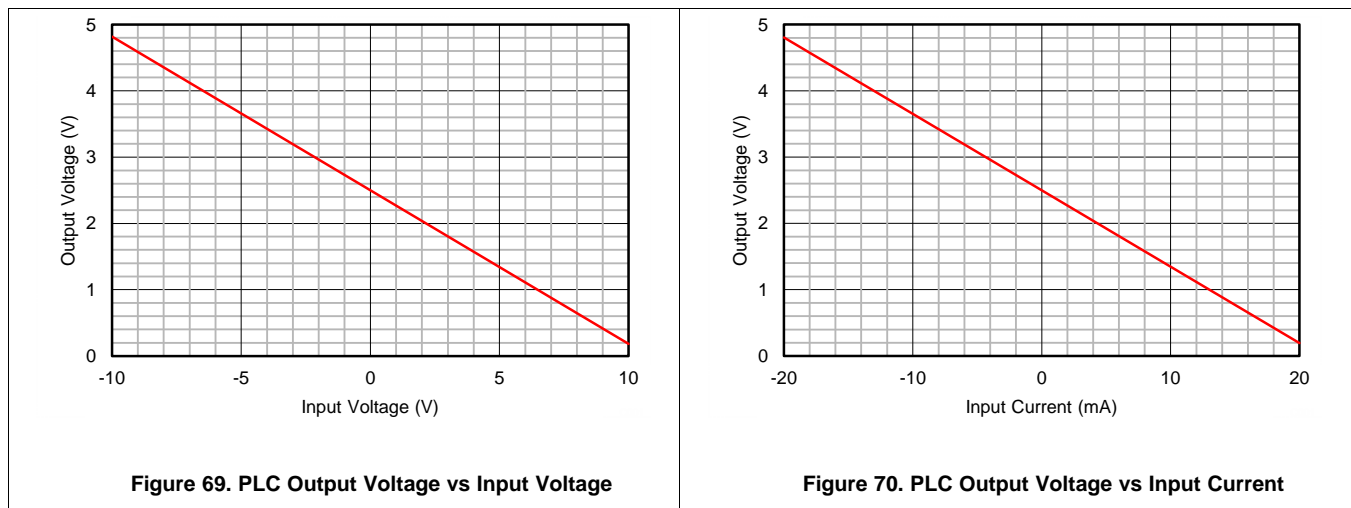

## 8.5 Other Application Examples

### 8.5.1 Resistance Temperature Detector Interface

Figure 71 illustrates a 3-wire interface circuit for resistance temperature detectors (RTDs). The circuit incorporates analog linearization and has an output voltage range from 0 to 5 V. The linearization technique employed is described in [Analog linearization of resistance temperature detectors](#). Series and parallel combinations of standard 1% resistor values are used to achieve less than 0.02°C of error over a 200°C temperature span.

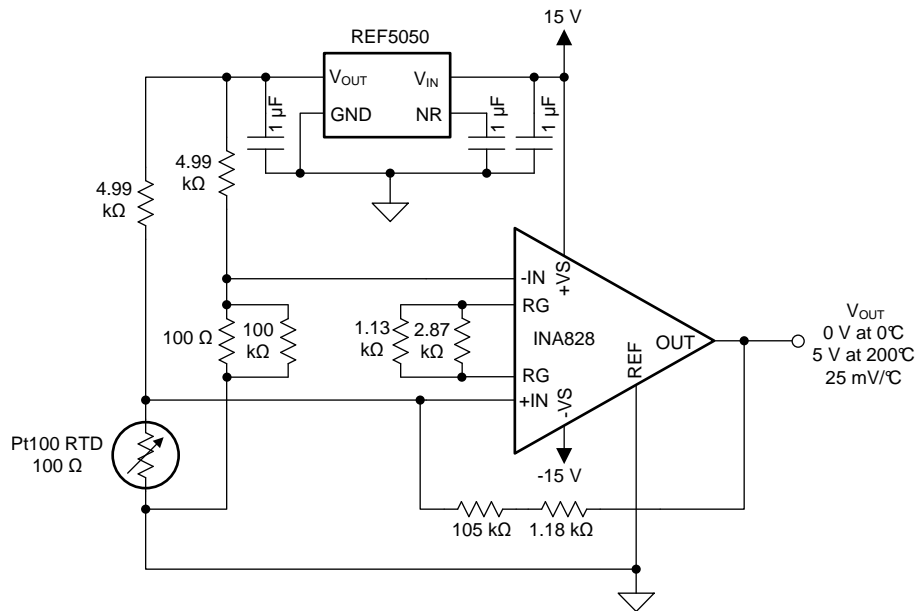

Copyright © 2017, Texas Instruments Incorporated

**Figure 71. A 3-Wire Interface for RTDs With Analog Linearization**

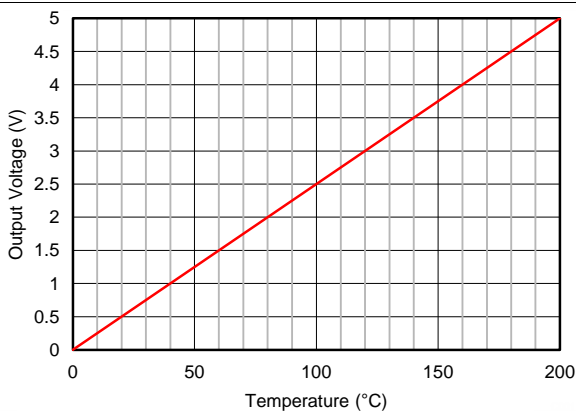

**Figure 72. Transfer Function of 3-Wire RTD Interface**

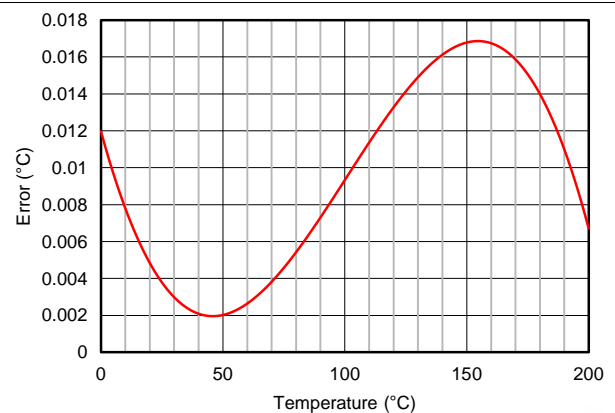

**Figure 73. Temperature Error Over Full Temperature Range**

## 9 Power Supply Recommendations

The nominal performance of the INA828 is specified with a supply voltage of  $\pm 15$  V and mid-supply reference voltage. The device can also be operated using power supplies from  $\pm 1.5$  V (3 V) to  $\pm 18$  V (36 V) and non mid-supply reference voltages with excellent performance. Parameters that can vary significantly with operating voltage and reference voltage are illustrated in the [Typical Characteristics](#) section.

## 10 Layout

### 10.1 Layout Guidelines

Attention to good layout practices is always recommended. For best operational performance of the device, use good PCB layout practices, including:

- Care must be taken to assure that both input paths are well-matched for source impedance and capacitance to avoid converting common-mode signals into differential signals. In addition, parasitic capacitance at the gain-setting pins can also affect CMRR over frequency. For example, in applications that implement gain switching using switches or PhotoMOS<sup>®</sup> relays to change the value of  $R_G$ , select the component so that the switch capacitance is as small as possible.
- Noise can propagate into analog circuitry through the power pins of the circuit as a whole and of the device itself. Bypass capacitors are used to reduce the coupled noise by providing low-impedance power sources local to the analog circuitry.
  - Connect low-ESR, 0.1- $\mu$ F ceramic bypass capacitors between each supply pin and ground, placed as close to the device as possible. A single bypass capacitor from  $V+$  to ground is applicable for single-supply applications.
- To reduce parasitic coupling, run the input traces as far away from the supply or output traces as possible. If these traces cannot be kept separate, crossing the sensitive trace perpendicular is much better than in parallel with the noisy trace.
- Place the external components as close to the device as possible. As illustrated in [Figure 74](#), keeping  $R_G$  close to the pins minimizes parasitic capacitance.
- Keep the traces as short as possible.

## 10.2 Layout Example

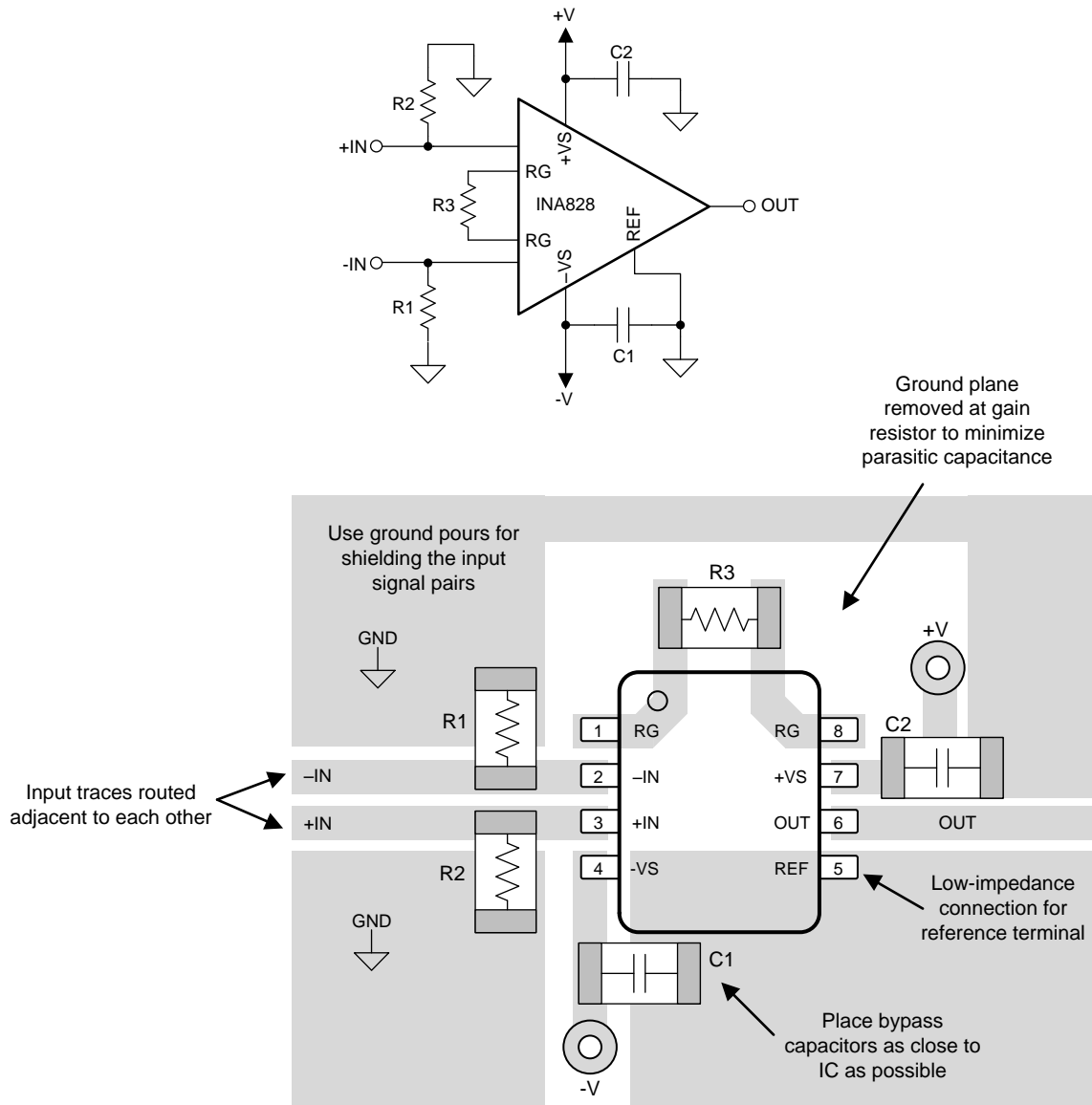

Copyright © 2017, Texas Instruments Incorporated

**Figure 74. Example Schematic and Associated PCB Layout**

## 11 Device and Documentation Support

### 11.1 Documentation Support

#### 11.1.1 Related Documentation

For related documentation see the following:

- [REF50xx Low-Noise, Very Low Drift, Precision Voltage Reference](#)
- [OPA191 Low-Power, Precision, 36-V, e-trim CMOS Amplifier](#)
- [TINA-TI software folder](#)
- [INA Common-Mode Range Calculator](#)

#### 11.2 Receiving Notification of Documentation Updates

To receive notification of documentation updates, navigate to the device product folder on ti.com. In the upper right corner, click on *Alert me* to register and receive a weekly digest of any product information that has changed. For change details, review the revision history included in any revised document.

#### 11.3 Community Resources

The following links connect to TI community resources. Linked contents are provided "AS IS" by the respective contributors. They do not constitute TI specifications and do not necessarily reflect TI's views; see TI's [Terms of Use](#).

**TI E2E™ Online Community** *TI's Engineer-to-Engineer (E2E) Community*. Created to foster collaboration among engineers. At e2e.ti.com, you can ask questions, share knowledge, explore ideas and help solve problems with fellow engineers.

**Design Support** *TI's Design Support* Quickly find helpful E2E forums along with design support tools and contact information for technical support.

#### 11.4 Trademarks

E2E is a trademark of Texas Instruments.

Bluetooth is a registered trademark of Bluetooth SIG, Inc.

PhotoMOS is a registered trademark of Panasonic Electric Works Europe AG.

All other trademarks are the property of their respective owners.

#### 11.5 Electrostatic Discharge Caution



This integrated circuit can be damaged by ESD. Texas Instruments recommends that all integrated circuits be handled with appropriate precautions. Failure to observe proper handling and installation procedures can cause damage.

ESD damage can range from subtle performance degradation to complete device failure. Precision integrated circuits may be more susceptible to damage because very small parametric changes could cause the device not to meet its published specifications.

#### 11.6 Glossary

[SLYZ022](#) — *TI Glossary*.

This glossary lists and explains terms, acronyms, and definitions.

## 12 Mechanical, Packaging, and Orderable Information

The following pages include mechanical, packaging, and orderable information. This information is the most current data available for the designated devices. This data is subject to change without notice and revision of this document. For browser-based versions of this data sheet, refer to the left-hand navigation.

**PACKAGING INFORMATION**

Orderable Device	Status (1)	Package Type	Package Drawing	Pins	Package Qty	Eco Plan (2)	Lead finish/ Ball material (6)	MSL Peak Temp (3)	Op Temp (°C)	Device Marking (4/5)	Samples
INA828ID	ACTIVE	SOIC	D	8	75	RoHS & Green	NIPDAU	Level-2-260C-1 YEAR	-40 to 125	INA828	<a href="#">Samples</a>
INA828IDR	ACTIVE	SOIC	D	8	2500	RoHS & Green	NIPDAU	Level-2-260C-1 YEAR	-40 to 125	INA828	<a href="#">Samples</a>

(1) The marketing status values are defined as follows:

**ACTIVE:** Product device recommended for new designs.

**LIFEBUY:** TI has announced that the device will be discontinued, and a lifetime-buy period is in effect.

**NRND:** Not recommended for new designs. Device is in production to support existing customers, but TI does not recommend using this part in a new design.

**PREVIEW:** Device has been announced but is not in production. Samples may or may not be available.

**OBSOLETE:** TI has discontinued the production of the device.

(2) **RoHS:** TI defines "RoHS" to mean semiconductor products that are compliant with the current EU RoHS requirements for all 10 RoHS substances, including the requirement that RoHS substance do not exceed 0.1% by weight in homogeneous materials. Where designed to be soldered at high temperatures, "RoHS" products are suitable for use in specified lead-free processes. TI may reference these types of products as "Pb-Free".

**RoHS Exempt:** TI defines "RoHS Exempt" to mean products that contain lead but are compliant with EU RoHS pursuant to a specific EU RoHS exemption.

**Green:** TI defines "Green" to mean the content of Chlorine (Cl) and Bromine (Br) based flame retardants meet JS709B low halogen requirements of <=1000ppm threshold. Antimony trioxide based flame retardants must also meet the <=1000ppm threshold requirement.

(3) MSL, Peak Temp. - The Moisture Sensitivity Level rating according to the JEDEC industry standard classifications, and peak solder temperature.

(4) There may be additional marking, which relates to the logo, the lot trace code information, or the environmental category on the device.

(5) Multiple Device Markings will be inside parentheses. Only one Device Marking contained in parentheses and separated by a "-" will appear on a device. If a line is indented then it is a continuation of the previous line and the two combined represent the entire Device Marking for that device.

(6) Lead finish/Ball material - Orderable Devices may have multiple material finish options. Finish options are separated by a vertical ruled line. Lead finish/Ball material values may wrap to two lines if the finish value exceeds the maximum column width.

**Important Information and Disclaimer:**The information provided on this page represents TI's knowledge and belief as of the date that it is provided. TI bases its knowledge and belief on information provided by third parties, and makes no representation or warranty as to the accuracy of such information. Efforts are underway to better integrate information from third parties. TI has taken and continues to take reasonable steps to provide representative and accurate information but may not have conducted destructive testing or chemical analysis on incoming materials and chemicals. TI and TI suppliers consider certain information to be proprietary, and thus CAS numbers and other limited information may not be available for release.

In no event shall TI's liability arising out of such information exceed the total purchase price of the TI part(s) at issue in this document sold by TI to Customer on an annual basis.





## TAPE AND REEL INFORMATION



### QUADRANT ASSIGNMENTS FOR PIN 1 ORIENTATION IN TAPE



\*All dimensions are nominal

Device	Package Type	Package Drawing	Pins	SPQ	Reel Diameter (mm)	Reel Width W1 (mm)	A0 (mm)	B0 (mm)	K0 (mm)	P1 (mm)	W (mm)	Pin1 Quadrant
INA828IDR	SOIC	D	8	2500	330.0	12.4	6.4	5.2	2.1	8.0	12.0	Q1

TAPE AND REEL BOX DIMENSIONS



\*All dimensions are nominal

Device	Package Type	Package Drawing	Pins	SPQ	Length (mm)	Width (mm)	Height (mm)
INA828IDR	SOIC	D	8	2500	853.0	449.0	35.0



D0008A

# PACKAGE OUTLINE

SOIC - 1.75 mm max height

SMALL OUTLINE INTEGRATED CIRCUIT



4214825/C 02/2019

### NOTES:

- Linear dimensions are in inches [millimeters]. Dimensions in parenthesis are for reference only. Controlling dimensions are in inches. Dimensioning and tolerancing per ASME Y14.5M.
- This drawing is subject to change without notice.
- This dimension does not include mold flash, protrusions, or gate burrs. Mold flash, protrusions, or gate burrs shall not exceed  $.006$  [0.15] per side.
- This dimension does not include interlead flash.
- Reference JEDEC registration MS-012, variation AA.

# EXAMPLE BOARD LAYOUT

D0008A

SOIC - 1.75 mm max height

SMALL OUTLINE INTEGRATED CIRCUIT



LAND PATTERN EXAMPLE  
 EXPOSED METAL SHOWN  
 SCALE:8X



SOLDER MASK DETAILS

4214825/C 02/2019

NOTES: (continued)

- 6. Publication IPC-7351 may have alternate designs.
- 7. Solder mask tolerances between and around signal pads can vary based on board fabrication site.

# EXAMPLE STENCIL DESIGN

D0008A

SOIC - 1.75 mm max height

SMALL OUTLINE INTEGRATED CIRCUIT



SOLDER PASTE EXAMPLE  
BASED ON .005 INCH [0.125 MM] THICK STENCIL  
SCALE:8X

4214825/C 02/2019

NOTES: (continued)

8. Laser cutting apertures with trapezoidal walls and rounded corners may offer better paste release. IPC-7525 may have alternate design recommendations.
9. Board assembly site may have different recommendations for stencil design.

## IMPORTANT NOTICE AND DISCLAIMER

TI PROVIDES TECHNICAL AND RELIABILITY DATA (INCLUDING DATASHEETS), DESIGN RESOURCES (INCLUDING REFERENCE DESIGNS), APPLICATION OR OTHER DESIGN ADVICE, WEB TOOLS, SAFETY INFORMATION, AND OTHER RESOURCES "AS IS" AND WITH ALL FAULTS, AND DISCLAIMS ALL WARRANTIES, EXPRESS AND IMPLIED, INCLUDING WITHOUT LIMITATION ANY IMPLIED WARRANTIES OF MERCHANTABILITY, FITNESS FOR A PARTICULAR PURPOSE OR NON-INFRINGEMENT OF THIRD PARTY INTELLECTUAL PROPERTY RIGHTS.

These resources are intended for skilled developers designing with TI products. You are solely responsible for (1) selecting the appropriate TI products for your application, (2) designing, validating and testing your application, and (3) ensuring your application meets applicable standards, and any other safety, security, or other requirements. These resources are subject to change without notice. TI grants you permission to use these resources only for development of an application that uses the TI products described in the resource. Other reproduction and display of these resources is prohibited. No license is granted to any other TI intellectual property right or to any third party intellectual property right. TI disclaims responsibility for, and you will fully indemnify TI and its representatives against, any claims, damages, costs, losses, and liabilities arising out of your use of these resources.

TI's products are provided subject to TI's Terms of Sale ([www.ti.com/legal/termsofsale.html](http://www.ti.com/legal/termsofsale.html)) or other applicable terms available either on [ti.com](http://ti.com) or provided in conjunction with such TI products. TI's provision of these resources does not expand or otherwise alter TI's applicable warranties or warranty disclaimers for TI products.

Mailing Address: Texas Instruments, Post Office Box 655303, Dallas, Texas 75265  
Copyright © 2020, Texas Instruments Incorporated