

RGTS



1-phase solid state soft starters



Benefits

- **Long lifetime.** Wire bonding technology reduces thermal and mechanical stresses of the output chips resulting in a larger number of possible operational cycles compared to other assembly technologies.
- **Ease of use.** The RGTS is a very simple soft starter requiring just 2 user adjustments.
- **Conforms to UL508A requirements for Industrial Control Panels.** The RGTS range is certified as a listed product. All models carry a 100 kArms Short Circuit Current Rating.
- **Wide supply voltage range.** The RGTS has 2 control voltage ranges: 24 VAC/DC or 100 - 240 VAC. This wide range ensures that the product works well even in installations with a weak power supply.
- **Fast wiring.** The RGTS does not require additional wires for the start/stop signal. It will start ramp-up function as soon as mains voltage is applied.

Description

RGTS is a compact and easy to use soft starter for single phase two wire AC induction motors. **RGTS** is a fully solid state solution.

Motor ramp-up time as well as initial torque can be independently adjusted through the built-in potentiometers.

A green LED gives indication of control voltage presence. Ramp-up and full-voltage indication are provided through an orange LED.

Applications

1-phase AC induction motors used in: pumps, compressors, fans, conveyors

Main features

- Fully solid state solution
- Wide supply voltage range: 100 - 240 VAC 50/60 Hz
- Voltage ramp soft start

Order code

 **RGTS 24** **0** **V00**

Enter the code entering the corresponding option instead of .

Code	Option	Description	Comments
R	-		
G	-	Solid state soft starter	
T	-		
S	-	Single-pole switching	
24	-	100 - 240 VACrms +10%, -15%	Operational Voltage (Ue)
<input type="checkbox"/>	12	12 A	Rated Operational Current (Ie)
	16	16 A	
	25	25 A	
0	-	Automatic start on presence of mains supply	Control Voltage (Uc)
<input type="checkbox"/>	F	24 VAC/DC	Supply Voltage (Us)
	G	100 – 240 VAC	
V00	-	No auxiliary relay output	

Selection guide

Rated operational current (Ie)	External Supply Voltage (Us)	Rated Operational Current (Arms)
12 Arms	24 VAC/DC	RGTS24120FV00
	100 - 240 VAC	RGTS24120GV00
16 Arms	24 VAC/DC	RGTS24160FV00
	100 - 240 VAC	RGTS24160GV00
25 Arms	24 VAC/DC	RGTS24250FV00
	100 - 240 VAC	RGTS24250GV00

Further reading

Information	Where to find it
RGTS instruction manual	http://www.productselection.net/MANUALS/UK/mc_il_rgts.pdf
RGTS Troubleshooting guide	http://www.gavazziautomation.com/document/manual/mc_rgts_qsg.pdf
CAD drawings (RGTS2412)	http://www.productselection.net/DXF/MC_RGTS2412.zip
CAD drawings (RGTS2416, RGTS2425)	http://www.productselection.net/DXF/MC_RGTS24_16_25.zip

Structure

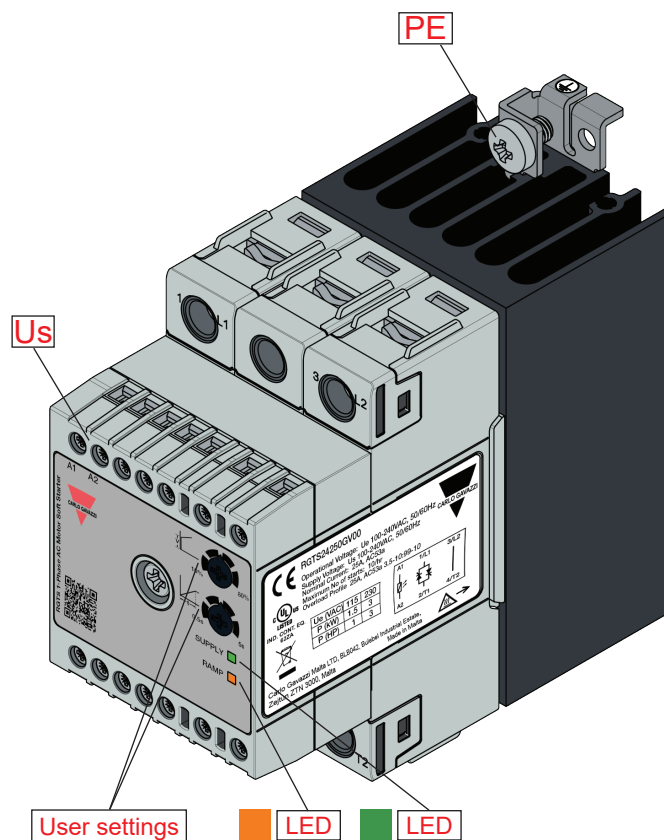

Element	Component	Function
1/L1, 3/L2	Power connections	Mains connections – L1 for live and L2 for Neutral (or L2) connection
2/T1, 2/T2	Power connections	Load connections - T1 for live and T2 for Neutral (or L2) connection
Us	Supply connection	Terminals for supply voltage
Green LED	Supply voltage indication	Indicates presence of supply voltage
Orange LED	Ramp-up/Full-voltage indication	Indicates status of RGTS
PE	Protective Earth	Connection for protective earth
User settings (1)	Initial torque setting	Sets the initial torque at which RGTS will start the ramp-up sequence. A lower initial torque results in a lower starting current.
User settings (2)	Ramp-up time setting	Sets the time at which the RGTS will reach full voltage at its output. Set the ramp-up time slightly longer than actual motor starting time.

Mode of operation

The RGTS series of soft starters works on a voltage ramp algorithm.

The user can adjust two independent settings: Initial torque (10% to 80%) and Ramp-up (0.5 to 5 sec)

- (1) Initial torque setting: The initial torque may be adjusted from 10% to 80%. A lower setting of the initial torque will result in a lower voltage at the output terminals of the RGTS when mains is applied to L1, L2.
- (2) Ramp-up time setting: This ramp-up time may be adjusted from 0.5 to 5 sec. This time is equivalent to the time that the RGTS will take to go from the output voltage corresponding to the initial torque setting to full voltage.
- (3) Ramp-down: The RGTS does not have ramp-down function. As soon as the mains is removed the RGTS will switch OFF its output and the motor will coast to stop.

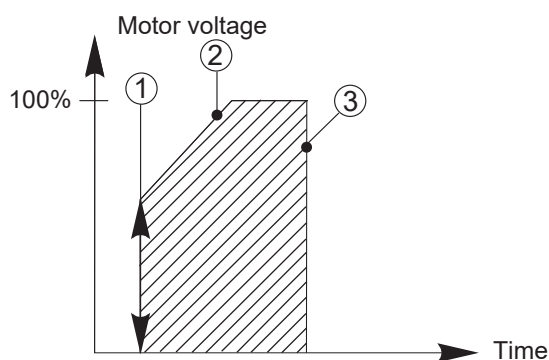

- ① Initial torque (10% - 80%): Voltage at the start of the ramp-up function.
- ② Ramp-up time 0.5 to 5 sec. Time from zero load voltage to full load voltage.
- ③ Coast to stop.

Features

General data

Material	PA66 (UL94 V0), RAL7035
Assembly	DIN rail
Touch protection	IP20
Weight	approx. 660 g
Overvoltage category	III (Fixed installations)

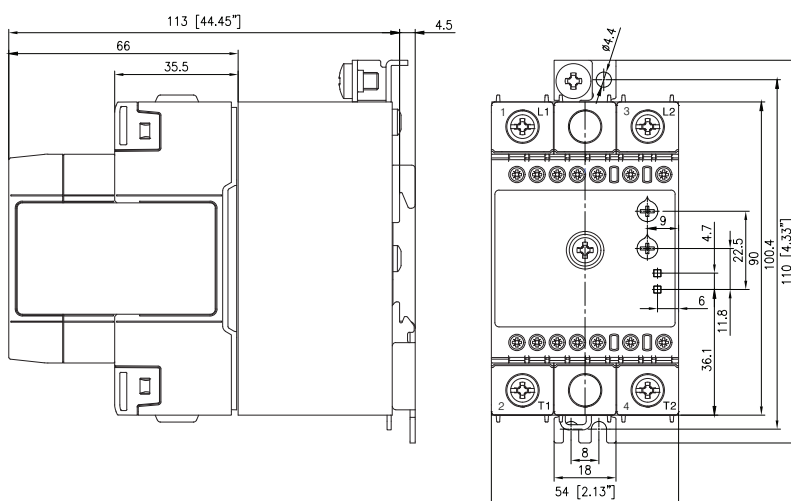

Fig. 1 RGTS2412

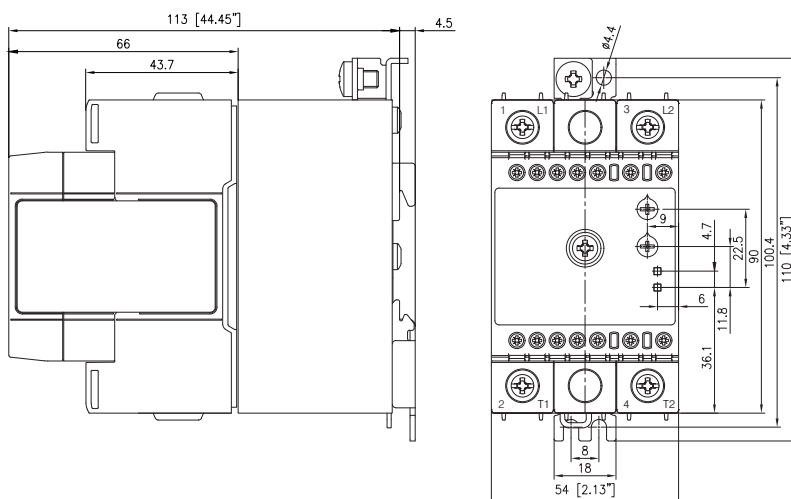

Fig. 2 RGTS2416, RGTS2425

Settings

Ramp-up time	0.5 - 5 sec
Ramp-down time	Not applicable
Initial torque	10% - 80%

Power supply (Us)

	RGTS24..0FV00	RGTS24..0GV00
Supply voltage range, Us	24VDC, -15%/+20%, 24VAC, -15%/+15%	90 – 265VAC
Isolation Input to Output Output to Case Input to Case	2.5 kVrms 4 kVrms 4 kVrms	
Max. supply current	80 mA	60 mA

Environmental

Working temperature	-40°C to +60°C (-40°F to +140°F)
Storage temperature	-40°C to +100°C (-40°F to +212°F)
Relative humidity	<95% non condensing @ 40°C
Pollution degree	2
Installation category	III (Fixed installations)
Installation altitude	0 - 1000 m
Vibration resistance	2g / axis (2 - 100 Hz, IEC60068-2-6, EN50155, EN61373)
Impact resistance	15/11 g/ms (EN50155, EN61373)
EU RoHS compliant	Yes

Inputs

Control voltage (Uc)	Not required. The RGTS shall be wired in series with a motor starter or contactor. Upon the presence of the mains supply voltage, the RGTS will start ramp-up function. Note: A1-A2 supply voltage has to be present.
----------------------	--

Outputs



	RGTS..12	RGTS..16	RGTS..25
Overload cycle @ 40°C surrounding temperature (acc. to IEC/EN 60947-4-2)	AC53a:3.5-10:99-10		
Maximum number of starts/hr @ rated overload cycle @ 40°C surrounding temperature	10	10	10
Rated operational current @ 40°C	12 AAC	16 AAC	25 AAC
Minimum operational current	250 mA	400 mA	400 mA
I ² t for fusing	1800 A ² s	6600 A ² s	6600 A ² s

Outputs

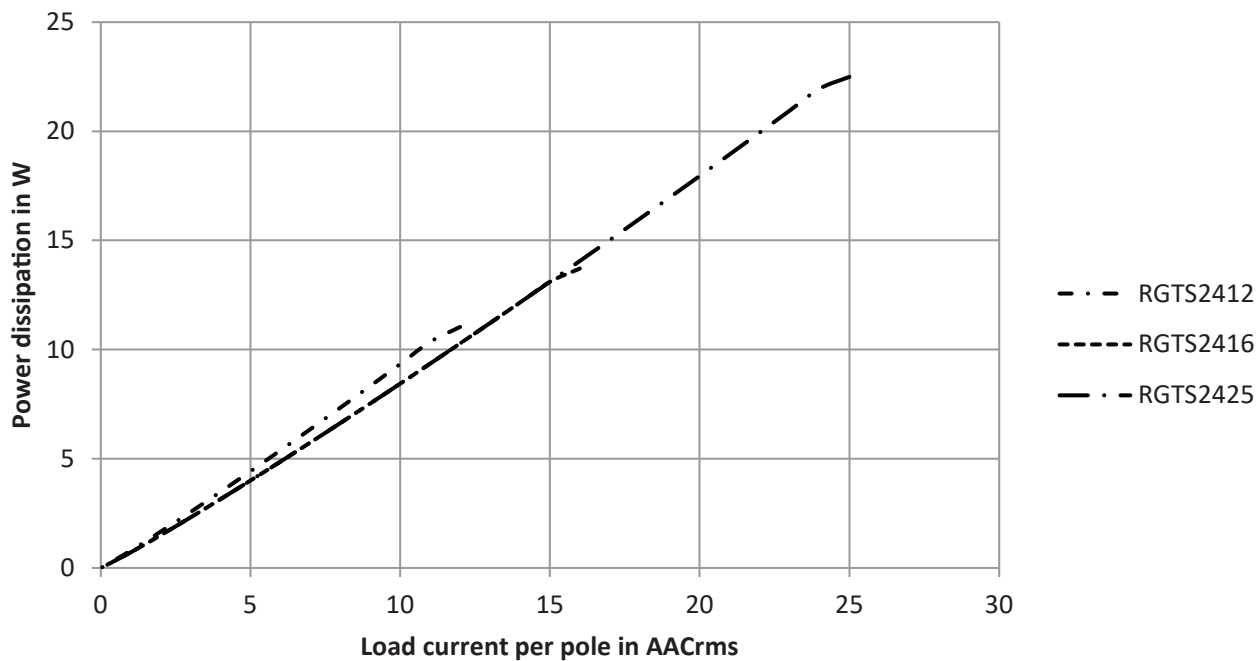
Output power dissipation



Compatibility and conformance

Conformance	LVD: EN/IEC 60947-4-2, EMCD: EN/IEC 60947-4-2 UL: UL508, E172877, cUL: C22.2 No.14-13, E172877
Approvals	 
UL short circuit current rating	100 kArms (refer to short circuit current section, Type 1 - UL508)

Electromagnetic compatibility (EMC) - immunity	
Electrostatic discharge (ESD)	EN/IEC 61000-4-2 8 kV air discharge, 4 kV contact (PC2)
Radiated radio frequency	EN/IEC 61000-4-3 10 V/m, from 80 MHz to 1 GHz (PC1) 10 V/m, from 1.4 to 2 GHz (PC1) 10 V/m, from 2 to 2.7 GHz (PC1)
Electrical Fast Transient (Burst)	EN/IEC 61000-4-4 Output: 2 kV, 5 kHz (PC1) Input: 1 kV, 5 kHz (PC1)
Conducted Radio Frequency	EN/IEC 61000-4-6 10 V/m, from 0.15 to 80 MHz (PC1)
Electrical Surge	EN/IEC 61000-4-5 Output, line to line: 1 kV (PC2) Output, line to earth: 2 kV (PC2) Input, line to line: 500 V (PC2) Input, line to earth: 500 V (PC2)
Voltage Dips	EN/IEC 61000-4-11 0% for 0.5, 1 cycle (PC2) 40% for 10 cycles (PC2) 70% for 25 cycles (PC2) 80% for 250 cycles (PC2)
Voltage interruptions	EN/IEC 61000-4-11 0% for 5000 ms (PC2)

Electromagnetic compatibility (EMC) - emissions	
Radio Interference field emission (Radiated)	EN/IEC 55011 Class A: from 30 to 1000 MHz
Radio interference field emissions (conducted)	EN/IEC 55011 Class A: from 0.15 to 30 MHz (External filter may be required - refer to Filtering section)

Filter Connection Diagram

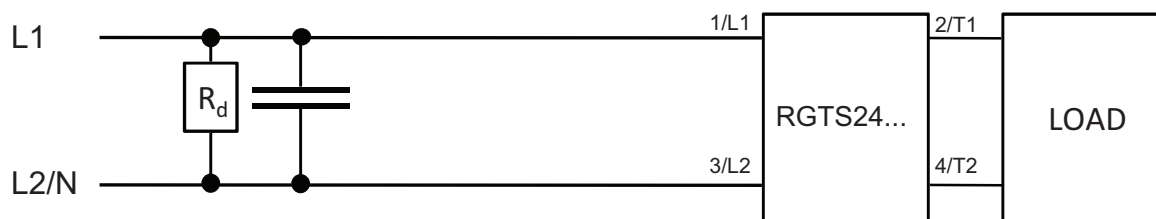

$$R_d = 1M\Omega, 0.5W$$

Filter has to be connected across both LOAD and the RGTS device

Filtering

Cat. No.	Suggested filter for compliance	Max. Motor current [A]
RGTS	No filter required	Up to 5 A
	10 nF / 275 V / X1	> 5 A to 10 A
	100 nF / 275 V / X1	> 10 A to 25 A

Note:

- Control input lines must be installed together to maintain products' susceptibility to Radio Frequency interference.
- Use of AC solid state relays may, according to the application and the load current, cause conducted radio interferences. Use of mains filters may be necessary for cases where the user must meet E.M.C requirements. The capacitor values given inside the filtering specification tables should be taken only as indications, the filter attenuation will depend on the final application.
- This product has been designed for Class A equipment. Use of this product in domestic environments may cause radio interference, in which case the user may be required to employ additional mitigation methods.
- Surge tests on RGTS models were carried out with the signal line impedance network. In case the line impedance is less than 40Ω, it is suggested that AC supply is provided through a secondary circuit where the short circuit limit between conductors or between conductors and ground is 1500 VA or less.
- Performance Criteria 1 (PC1): No degradation of performance or loss of function is allowed when the product is operated as intended.
- Performance Criteria 2 (PC2): During the test, degradation of performance or partial loss of function is allowed. However when the test is complete the product should return operating as intended by itself.
- Performance Criteria 3 (PC3): Temporary loss of function is allowed, provided the function can be restored by manual operation of the controls.

Performance

Current / power ratings: kW and HP @ 40°C

Model	IEC rated current	110 – 120 VAC	220 – 240 VAC
RGTS24...	12 Arms	0.55kW / 0.5 HP	1.1 kW / 2 HP
	16 Arms	0.55kW / 0.5 HP	1.5 kW / 2 HP
	25 Arms	1.5 kW / 1 HP	3 kW / 3 HP

Ratings:

kW rating according to IEC/EN 60947-4-2

HP rating according to UL60947-4-2

Current derating curves (by temperature)

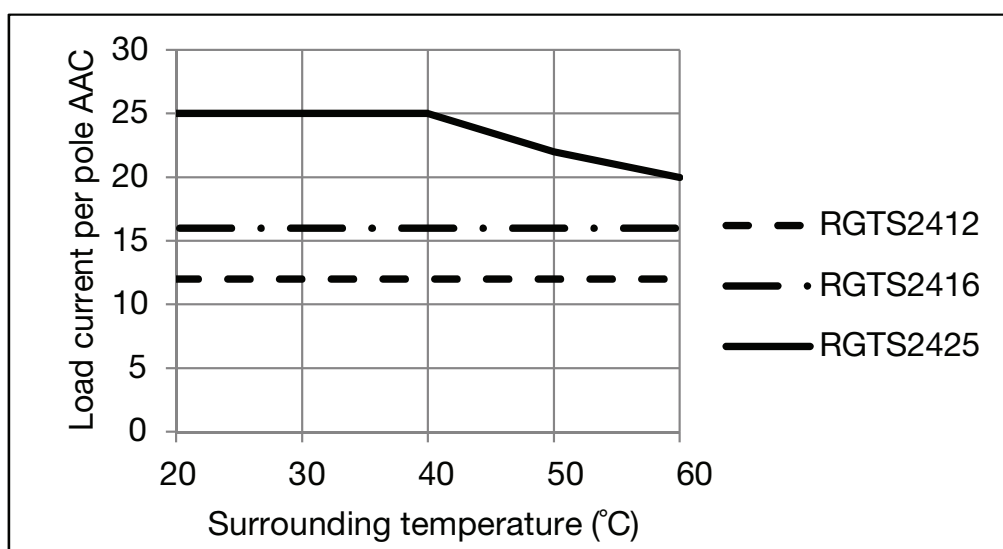

Derating vs Spacing Curves

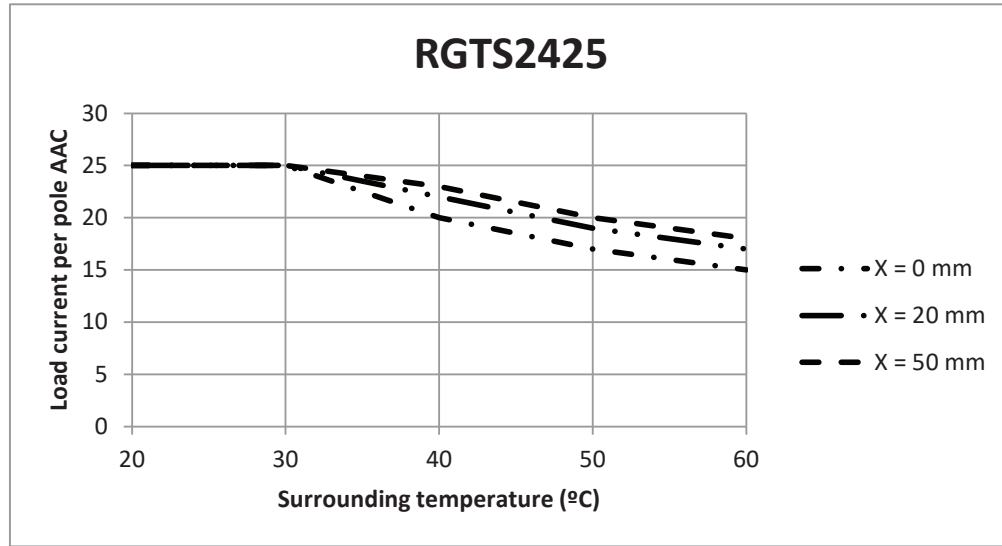
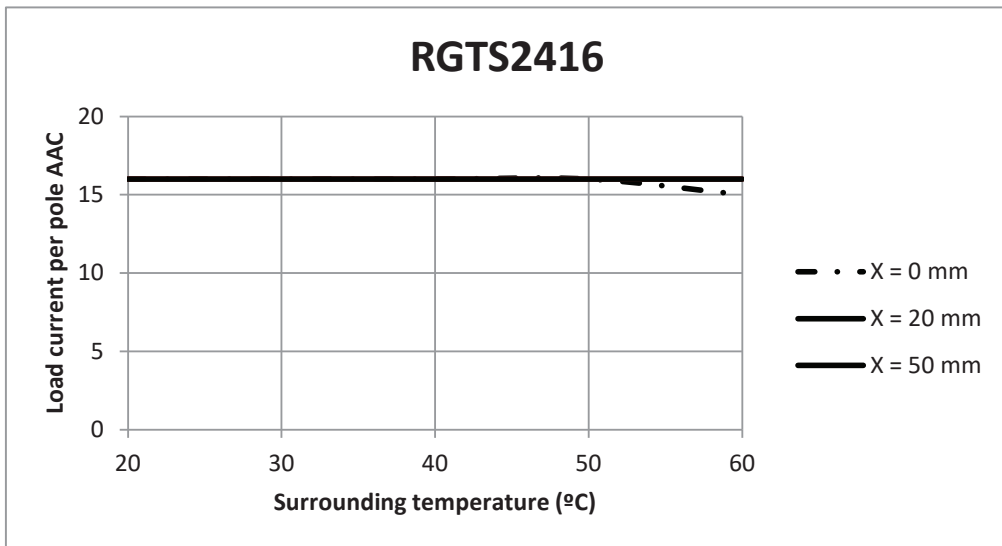
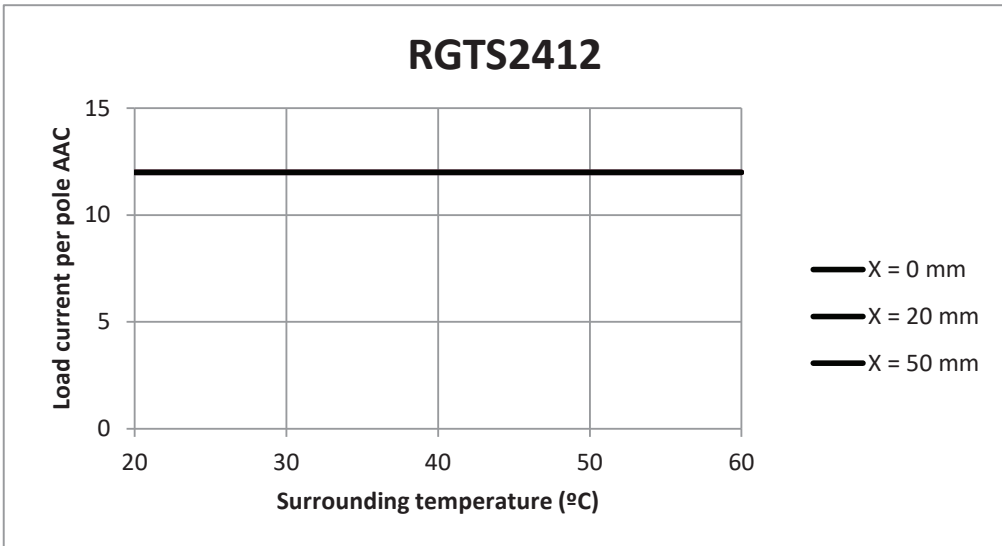

Connection diagrams

▶ Connection configuration

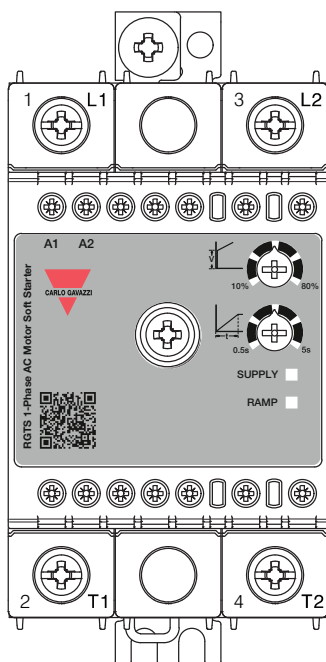

▶ Terminal markings

Marking	
1L1, 3/L2	Line connections (L2 or Neutral)
2/T1, 4/T2	Load connections
A1, A2	Supply voltage
PE	Protective earth connection

Connection diagrams

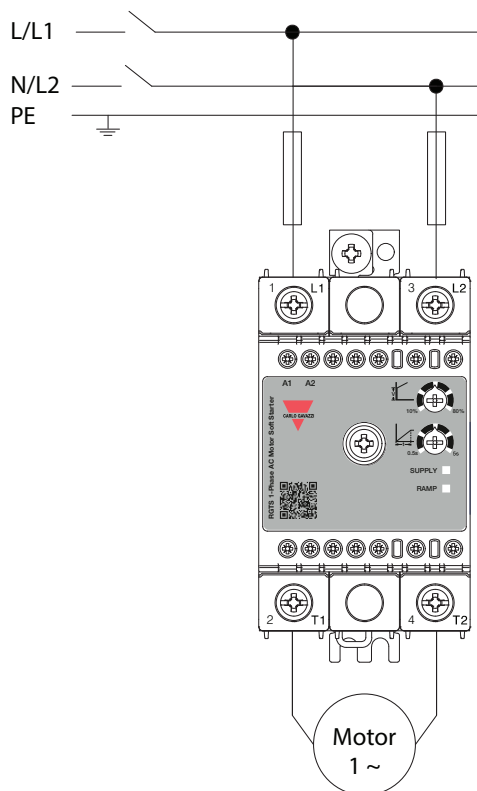

Installation

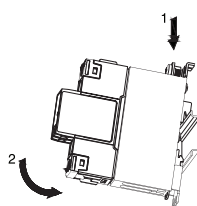
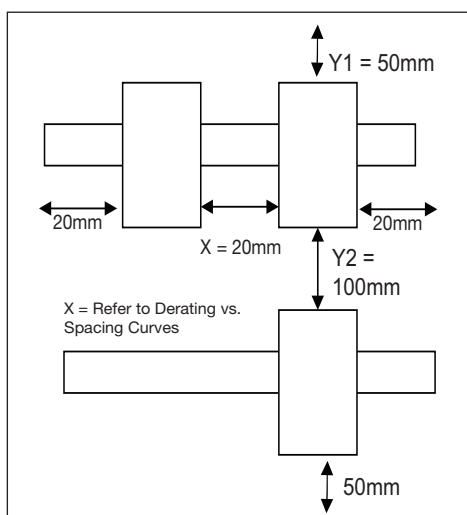

- Mounting on DIN rail
- Montage på DIN-skinne
- Montage sur rail DIN
- Befestigung auf der DIN-Schiene
- Montaje a carril DIN
- Montaggio su guida DIN

**HOT
WARME
CHAUD
HEISS
CALDO
CALIENTE**

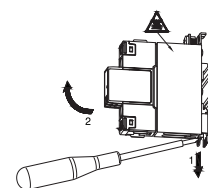

- Dismounting from DIN rail
- Dismounting from DIN rail
- Dépose d'un RGTS monté sur rail DIN
- Demontage von der DIN-Schiene
- Desmontaje a carril DIN
- Smontaggio da guida DIN

Wiring Diagrams

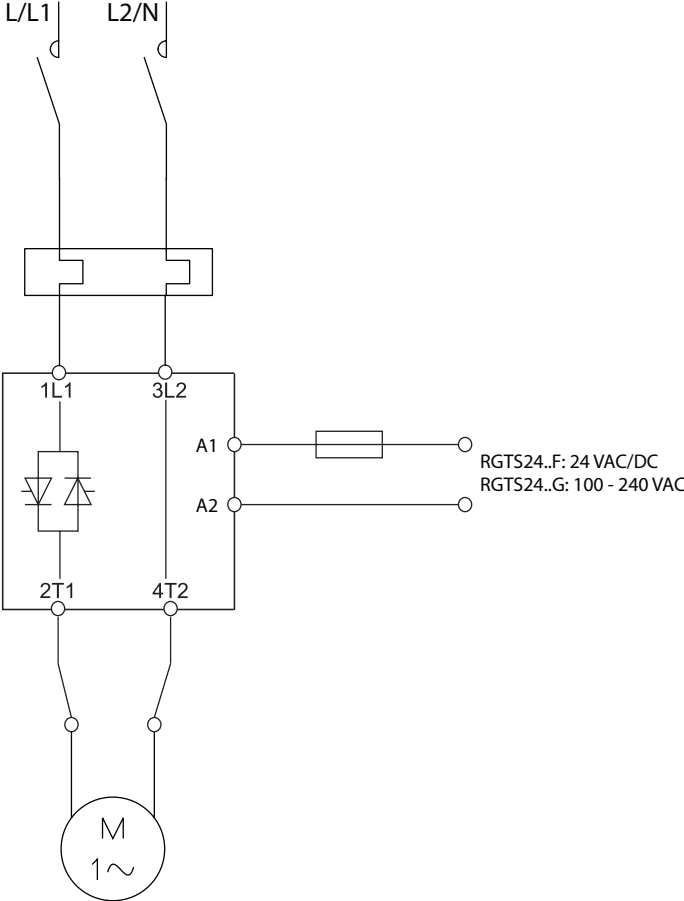

Connection Specifications

Power Connections (1/L1, 3/L2, 2/T1, 4/T2)	RGTS...12	RGTS...16 – RGTS...25
Stripping length	12 mm	11 mm
Connection type	M4 screw with captivated washer	M5 screw with Box Clamp
Rigid (Solid & Stranded) UL/cUL rated data	1 x 2.5 - 6 mm ² 1x 14 - 10 AWG	1 x 2.5 - 25 mm ² 1x 14 – 3 AWG
Flexible with end sleeve	1x 1.0 – 4.0 mm ² 1X 18 - 12 AWG	1x 2.5 - 16 mm ² 1x 14 - 6 AWG
Flexible without end sleeve	1x 1.0 – 6.0 mm ² 1X 18 - 10 AWG	1 x 4.0 - 25 mm ² 1x 12 - 3 AWG
Torque Specifications	Pozidriv 2 UL: 2 Nm (17.7 lb-in) IEC: 1.5-2.0 Nm (13.3-17.7lb.in)	Pozidriv 2 UL: 2.5 Nm (22 lb-in) IEC: 2.5-3.0 Nm (22-26.6lb-in)
Protective Earth Connection	M5, 1.5 Nm (13.3 in-lb)	

Note: Use 75°C Copper (Cu) conductors

Note: Protective earth connection must be connected whenever the product is intended to be used in Class 1 applications according to EN/IEC 61140

Secondary conductors (A1, A2)	RGTS...12	RGTS...16 – RGTS...25
Stripping length	8 mm	
Connection type	M3 screw with Box Clamp	
Rigid (Solid & Stranded) UL/cUL rated data	1x 1.0...2.5 mm ² 1x 18...12 AWG	
Flexible with end sleeve	1x 0.5...2.5 mm ² 1x 20...12 AWG	
Torque Specifications	Pozidriv 1 UL:0.5 Nm (4.4lb-in), IEC: 0.4-0.5 Nm (3.5-4.4lb-in)	

Troubleshooting

LED Status indications

State	Supply (Green LED)	Ramp/Full-voltage (Orange LED)
Idle	ON	OFF
Ramping	ON	Flashing
Fully ON	ON	ON

Short circuit protection

Protection Co-ordination, Type 1 vs Type 2:

Type 1 protection implies that after a short circuit, the device under test will no longer be in a functioning state. In Type 2 co-ordination the device under test will still be functional after the short circuit. In both cases, however the short circuit has to be interrupted. The fuse between enclosure and supply shall not open. The door or cover of the enclosure shall not be blown open. There shall be no damage to conductors or terminals and the conductors shall not separate from terminals. There shall be no breakage or cracking of insulating bases to the extent that the integrity of the mounting of live parts is impaired. Discharge of parts or any risk of fire shall not occur.

The product variants listed in the table hereunder are suitable for use on a circuit capable of delivering not more than 100,000A rms Symmetrical Amperes, 600 Volts maximum when protected by fuses. Tests at 100,000A were performed with Class J fuses, fast acting; please refer to the table below for maximum allowed ampere rating of the fuse. Use fuses only.

Tests with Class J fuses are representative of Class CC fuses.

Protection co-ordination Type 1 according to UL 508				
Part No.	Prospective short circuit current [kArms]	Max fuse size [A]	Class	Voltage [VAC]
RGTS2412	100	30	J or CC	Max. 600 VAC
RGTS2416				
RGTS2425				

Protection co-ordination Type 2						
Part No.	Prospective short circuit current [kArms]	Ferraz Shawmut (Mersen)		Siba		Voltage [VAC]
		Max fuse size [A]	Part number	Max fuse size [A]	Part number	
RGTS2412	100	40	A70QS40-4	50	50 142 06 50	Max. 600 VAC
RGTS2416		60	A70QS60-4	80	50 194 20 80	
RGTS2425		90	A70QS90-4	100	50 194 20 100	

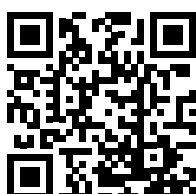

COPYRIGHT ©2018
Content subject to change. Download the PDF: www.productselection.net

Mouser Electronics

Authorized Distributor

Click to View Pricing, Inventory, Delivery & Lifecycle Information:

[Carlo Gavazzi:](#)

[RGTS24250GV00](#) [RGTS24120GV00](#) [RGTS24250FV00](#) [RGTS24120FV00](#)