

## SOT-723 Plastic-Encapsulate MOSFETS

### SK3134K N-Channel MOSFET

$V_{(BR)DSS}$	$R_{DS(on)MAX}$	$I_D$
20V	380mΩ@4.5V	0.75A
	450mΩ@2.5V	
	800mΩ@1.8V	

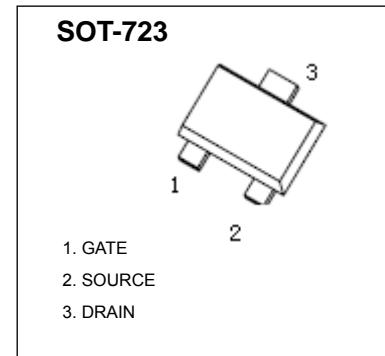

#### FEATURES

- Lead Free Product is Acquired
- Surface Mount Package
- N-Channel Switch with Low  $R_{DS(on)}$
- Operated at Low Logic Level Gate Drive

#### APPLICATION

- Load/Power Switching
- Interfacing Switching
- Battery Management for Ultra Small Portable Electronics
- Logic Level Shift

#### MARKING

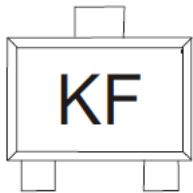

#### Equivalent Circuit

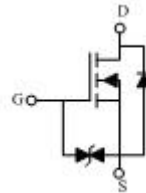

#### Maximum ratings ( $T_a=25^\circ\text{C}$ unless otherwise noted)

Parameter	Symbol	Value	Unit
Drain-Source Voltage	$V_{DS}$	20	V
Typical Gate-Source Voltage	$V_{GS}$	±12	V
Continuous Drain Current (note 1)	$I_D$	0.75	A
Pulsed Drain Current ( $t_p=10\ \mu\text{s}$ )	$I_{DM}$	1.8	A
Power Dissipation (note 1)	$P_D$	150	mW
Thermal Resistance from Junction to Ambient (note 1)	$R_{\theta JA}$	833	$^\circ\text{C}/\text{W}$
Junction Temperature	$T_J$	150	$^\circ\text{C}$
Storage Temperature	$T_{STG}$	-55~+150	$^\circ\text{C}$
Lead Temperature for Soldering Purposes(1/8" from case for 10 s)	$T_L$	260	$^\circ\text{C}$

**MOSFET ELECTRICAL CHARACTERISTICS**
 **$T_a=25^\circ\text{C}$  unless otherwise specified**

Parameter	Symbol	Test Condition	Min	Typ	Max	Unit
<b>STATIC CHARACTERISTICS</b>						
Drain-source breakdown voltage	$V_{(BR)DSS}$	$V_{GS} = 0V, I_D = 250\mu A$	20			V
Zero gate voltage drain current	$I_{DSS}$	$V_{DS} = 20V, V_{GS} = 0V$			1	$\mu A$
Gate-body leakage current	$I_{GSS}$	$V_{GS} = \pm 10V, V_{DS} = 0V$			$\pm 20$	$\mu A$
Gate threshold voltage (note 2)	$V_{GS(th)}$	$V_{DS} = V_{GS}, I_D = 250\mu A$	0.35	0.54	1.1	V
Drain-source on-resistance (note 2)	$R_{DS(on)}$	$V_{GS} = 4.5V, I_D = 0.65A$		270	380	$m\Omega$
		$V_{GS} = 2.5V, I_D = 0.55A$		320	450	$m\Omega$
		$V_{GS} = 1.8V, I_D = 0.45A$		390	800	$m\Omega$
Forward transconductance (note 2)	$g_{FS}$	$V_{DS} = 10V, I_D = 0.8A$		1.6		S
Diode forward voltage	$V_{SD}$	$I_S = 0.15A, V_{GS} = 0V$			1.2	V
<b>DYNAMIC CHARACTERISTICS (note 4)</b>						
Input capacitance	$C_{iss}$	$V_{DS} = 16V, V_{GS} = 0V, f = 1MHz$		79	120	pF
Output capacitance	$C_{oss}$			13	20	pF
Reverse transfer capacitance	$C_{rss}$			9	15	pF
<b>SWITCHING CHARACTERISTICS (note 4)</b>						
Turn-on delay time (note 3)	$t_{d(on)}$	$V_{GS} = 4.5V, V_{DS} = 10V,$ $I_D = 500mA, R_{GEN} = 10\Omega$		6.7		ns
Turn-on rise time (note 3)	$t_r$			4.8		ns
Turn-off delay time (note 3)	$t_{d(off)}$			17.3		ns
Turn-off fall time (note 3)	$t_f$			7.4		ns
Total Gate Charge $Q_g [nC]$	$Q_g$	$V_{DS} = 10V, V_{GS} = 4.5V, I_D = 0.65A$		11		nC
Gate-Source Charge $Q_{gs} [nC]$	$Q_{gs}$			11		nC
Gate-Drain Charge $Q_{gd} [nC]$	$Q_{gd}$			11		nC

**Notes :**

1. Surface mounted on FR4 board using the minimum recommended pad size.
2. Pulse Test : Pulse Width=300 $\mu s$ , Duty Cycle=2%.
3. Switching characteristics are independent of operating junction temperatures.
4. Guaranteed by design, not subject to producing.

## Typical Characteristics

### Output Characteristics

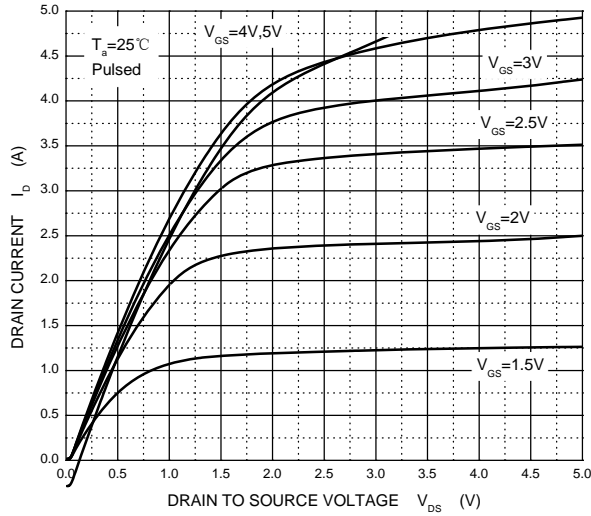

### Transfer Characteristics

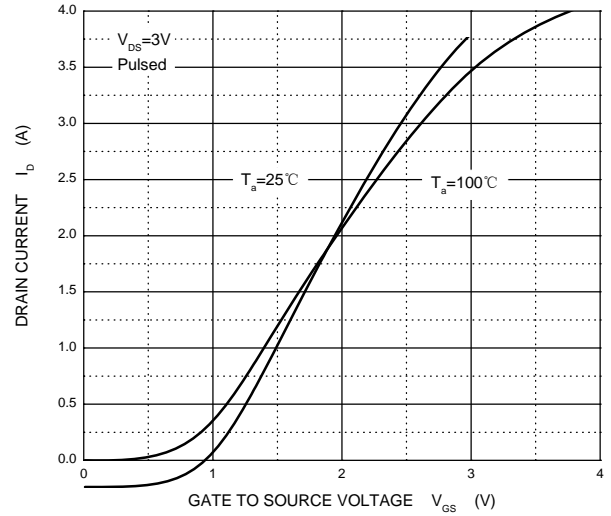

### $R_{DS(ON)}$ — $I_D$

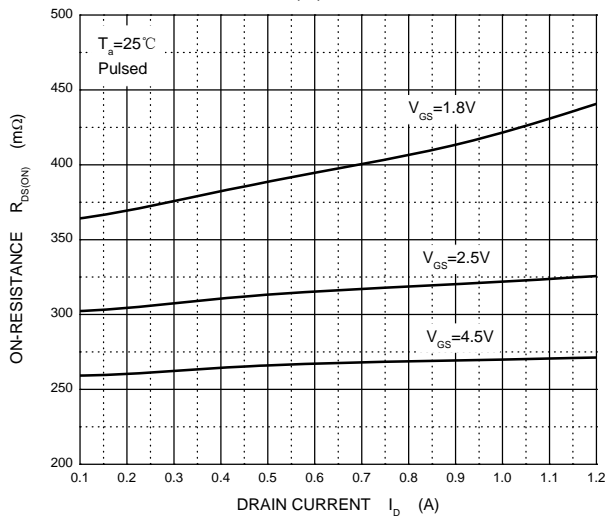

### $R_{DS(ON)}$ — $V_{GS}$

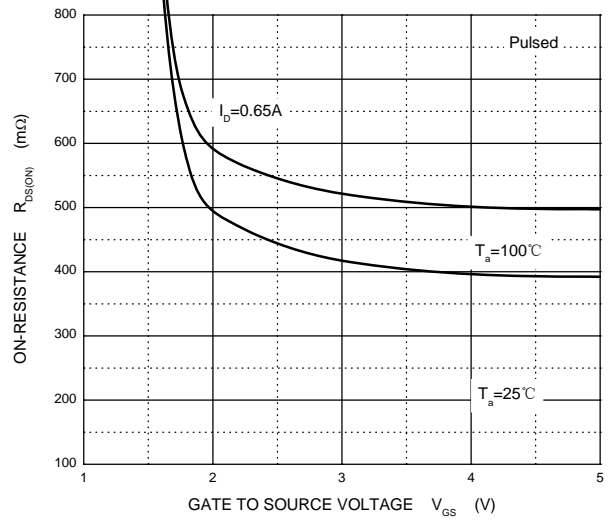

### $I_s$ — $V_{SD}$

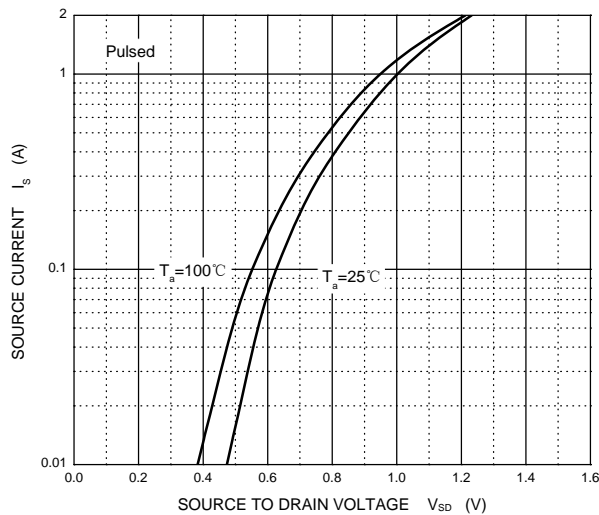

### Threshold Voltage

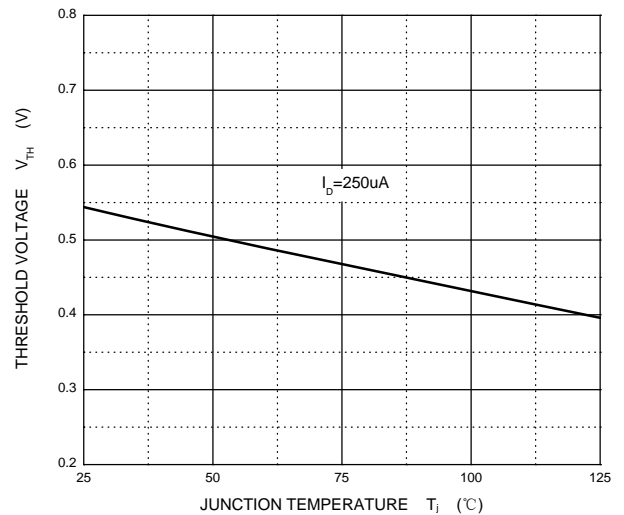

## SOT-723 Package Outline Dimensions

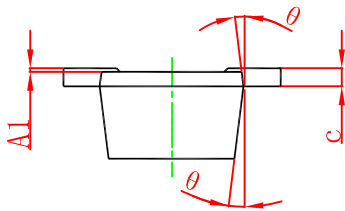
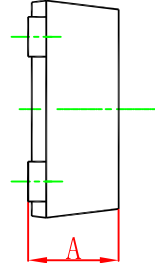
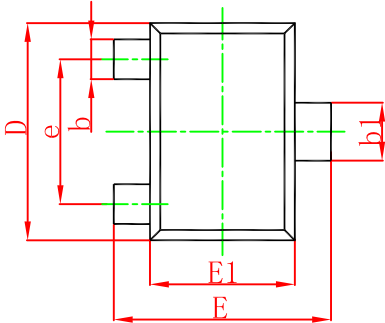

Symbol	Dimensions In Millimeters		Dimensions In Inches	
	Min.	Max.	Min.	Max.
A	0.430	0.500	0.017	0.020
A1	0.000	0.050	0.000	0.002
b	0.170	0.270	0.007	0.011
b1	0.270	0.370	0.011	0.015
c	0.080	0.150	0.003	0.006
D	1.150	1.250	0.045	0.049
E	1.150	1.250	0.045	0.049
E1	0.750	0.850	0.030	0.033
e	0.800TYP.		0.031TYP.	
$\theta$	7° REF.		7° REF.	

## SOT-723 Suggested Pad Layout

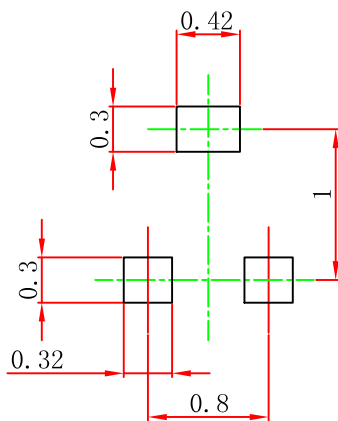

- Note:
1. Controlling dimension: in millimeters.
  2. General tolerance:  $\pm 0.05\text{mm}$ .
  3. The pad layout is for reference purposes only.