

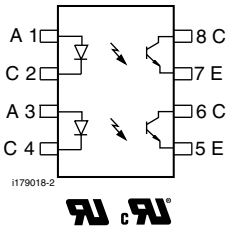

## Optocoupler, Phototransistor Output, Dual Channel, SOIC-8 Package



i179025



### DESCRIPTION

The ILD205T, ILD206T, ILD207T, ILD211T, and ILD213T are optically coupled pairs with a gallium arsenide infrared LED and a silicon NPN phototransistor. Signal information, including a DC level, can be transmitted by the device while maintaining a high degree of electrical isolation between input and output. The ILD205T, ILD206T, ILD207T, ILD211T, and ILD213T come in a standard SOIC-8 small outline package for surface mounting which makes it ideally suited for high density applications with limited space. In addition to eliminating through-holes requirements, this package conforms to standards for surface mounted devices.

A specified minimum and maximum CTR allows a narrow tolerance in the electrical design of the adjacent circuits. The high  $BV_{CEO}$  of 70 V gives a higher safety margin compared to the industry standard of 30 V.

### FEATURES

- Two channel coupler
- SOIC-8 surface mountable package
- Standard lead spacing of 0.05"
- Available only on tape and reel option (conforms to EIA standard 481-2)
- Isolation test voltage, 4000  $V_{RMS}$
- Compatible with dual wave, vapor phase and IR reflow soldering
- Material categorization: for definitions of compliance please see [www.vishay.com/doc?99912](http://www.vishay.com/doc?99912)



RoHS COMPLIANT

### AGENCY APPROVALS

- UL1577, file no. E52744 system code Y
- cUL - file no. E52744, equivalent to CSA bulletin 5A

ORDERING INFORMATION							
I	L	D	2	#	#	T	
PART NUMBER							
AGENCY CERTIFIED/PACKAGE	CTR (%)						
	10 mA						
UL, cUL	40 to 80	63 to 125	100 to 200	≥ 20	≥ 100		
SOIC-8	ILD205T	ILD206T	ILD207T	ILD211T	ILD213T		



ABSOLUTE MAXIMUM RATINGS (T <sub>amb</sub> = 25 °C, unless otherwise specified)				
PARAMETER	TEST CONDITION	SYMBOL	VALUE	UNIT
<b>INPUT</b>				
Peak reverse voltage		V <sub>R</sub>	6	V
Peak pulsed current	1 μs, 300 pps		1	A
Continuous forward current per channel		I <sub>F</sub>	30	mA
Power dissipation		P <sub>diss</sub>	50	mW
<b>OUTPUT</b>				
Collector emitter breakdown voltage		BV <sub>CEO</sub>	70	V
Emitter collector breakdown voltage		BV <sub>ECO</sub>	7	V
Power dissipation per channel		P <sub>diss</sub>	125	mW
<b>COUPLER</b>				
Total package dissipation ambient (2 LEDs and 2 detectors, 2 channels)		P <sub>tot</sub>	350	mW
Storage temperature		T <sub>stg</sub>	-55 to +150	°C
Operating temperature		T <sub>amb</sub>	-55 to +100	°C
Soldering time from 260 °C <sup>(1)</sup>		T <sub>slid</sub>	10	s

**Notes**

- Stresses in excess of the absolute maximum ratings can cause permanent damage to the device. Functional operation of the device is not implied at these or any other conditions in excess of those given in the operational sections of this document. Exposure to absolute maximum ratings for extended periods of the time can adversely affect reliability.
- <sup>(1)</sup> Refer to reflow profile for soldering conditions for surface mounted devices.

ELECTRICAL CHARACTERISTICS (T <sub>amb</sub> = 25 °C, unless otherwise specified)						
PARAMETER	TEST CONDITION	SYMBOL	MIN.	TYP.	MAX.	UNIT
<b>INPUT</b>						
Forward voltage	I <sub>F</sub> = 10 mA	V <sub>F</sub>	-	1.2	1.55	V
Reverse current	V <sub>R</sub> = 6 V	I <sub>R</sub>	-	0.1	100	μA
Capacitance	V <sub>R</sub> = 0 V	C <sub>O</sub>	-	25	-	pF
<b>OUTPUT</b>						
Collector emitter breakdown voltage	I <sub>C</sub> = 10 μA	BV <sub>CEO</sub>	70	-	-	V
Emitter collector breakdown voltage	I <sub>E</sub> = 10 μA	BV <sub>ECO</sub>	7	-	-	V
Collector emitter leakage current	V <sub>CE</sub> = 10 V, I <sub>F</sub> = 0 A	I <sub>CEO</sub>	-	5	50	nA
Collector emitter capacitance	V <sub>CE</sub> = 0 V	C <sub>CE</sub>	-	10	-	pF
<b>COUPLER</b>						
Collector emitter saturation voltage	I <sub>F</sub> = 10 mA, I <sub>C</sub> = 2.5 mA	V <sub>CEsat</sub>	-	-	0.4	V
Capacitance (input to output)		C <sub>IO</sub>	-	0.5	-	pF

**Note**

- Minimum and maximum values were tested requirements. Typical values are characteristics of the device and are the result of engineering evaluations. Typical values are for information only and are not part of the testing requirements.

CURRENT TRANSFER RATIO (T <sub>amb</sub> = 25 °C, unless otherwise specified)							
PARAMETER	TEST CONDITION	PART	SYMBOL	MIN.	TYP.	MAX.	UNIT
I <sub>C</sub> /I <sub>F</sub>	V <sub>CE</sub> = 5 V, I <sub>F</sub> = 10 mA	ILD205T	CTR <sub>DC</sub>	40	-	80	%
		ILD206T	CTR <sub>DC</sub>	63	-	125	%
		ILD207T	CTR <sub>DC</sub>	100	-	200	%
		ILD211T	CTR <sub>DC</sub>	20	-	-	%
		ILD213T	CTR <sub>DC</sub>	100	-	-	%
	V <sub>CE</sub> = 5 V, I <sub>F</sub> = 1 mA	ILD205T	CTR <sub>DC</sub>	13	30	-	%
		ILD206T	CTR <sub>DC</sub>	22	45	-	%
		ILD207T	CTR <sub>DC</sub>	34	70	-	%

<b>SWITCHING CHARACTERISTICS</b> ( $T_{amb} = 25\text{ }^{\circ}\text{C}$ , unless otherwise specified)						
PARAMETER	TEST CONDITION	SYMBOL	MIN.	TYP.	MAX.	UNIT
Delay time	$V_S = 5\text{ V}$ , $I_C = 2\text{ mA}$ , $R_L = 100\text{ }\Omega$ , (see figure 1)	$t_d$	-	3	-	$\mu\text{s}$
Rise time	$V_S = 5\text{ V}$ , $I_C = 2\text{ mA}$ , $R_L = 100\text{ }\Omega$ , (see figure 1)	$t_r$	-	3	-	$\mu\text{s}$
Fall time	$V_S = 5\text{ V}$ , $I_C = 2\text{ mA}$ , $R_L = 100\text{ }\Omega$ , (see figure 1)	$t_f$	-	4.7	-	$\mu\text{s}$
Storage time	$V_S = 5\text{ V}$ , $I_C = 2\text{ mA}$ , $R_L = 100\text{ }\Omega$ , (see figure 1)	$t_s$	-	0.3	-	$\mu\text{s}$
Turn-on time	$V_S = 5\text{ V}$ , $I_C = 2\text{ mA}$ , $R_L = 100\text{ }\Omega$ , (see figure 1)	$t_{on}$	-	6	-	$\mu\text{s}$
Turn-off time	$V_S = 5\text{ V}$ , $I_C = 2\text{ mA}$ , $R_L = 100\text{ }\Omega$ , (see figure 1)	$t_{off}$	-	5	-	$\mu\text{s}$
Turn-on time	$V_S = 5\text{ V}$ , $I_F = 10\text{ mA}$ , $R_L = 1\text{ k}\Omega$ , (see figure 2)	$t_{on}$	-	3	-	$\mu\text{s}$
Turn-off time	$V_S = 5\text{ V}$ , $I_F = 10\text{ mA}$ , $R_L = 1\text{ k}\Omega$ , (see figure 2)	$t_{off}$	-	10	-	$\mu\text{s}$

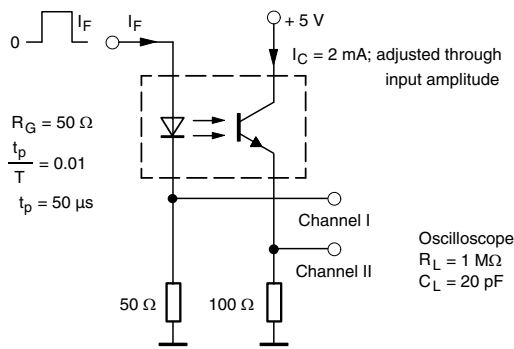

95 10804

Fig. 1 - Test Circuit, Non-Saturated Operation

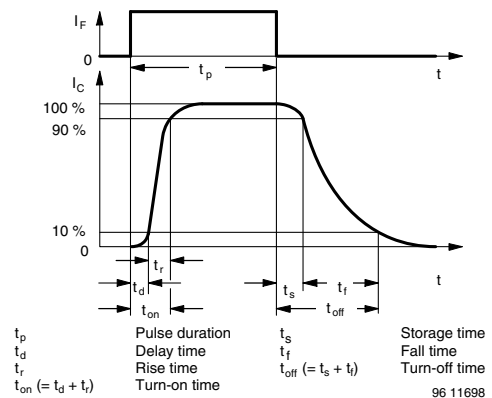
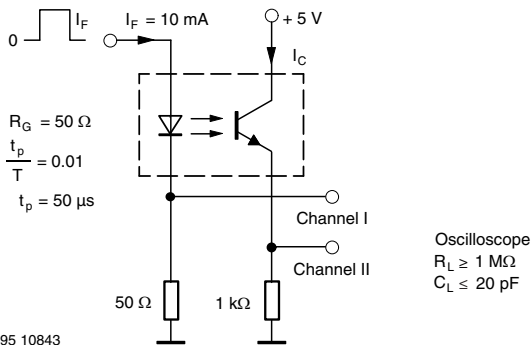

Fig. 3 - Switching Times



95 10843

Fig. 2 - Test Circuit, Saturated Operation



SAFETY AND INSULATION RATINGS				
PARAMETER	TEST CONDITION	SYMBOL	VALUE	UNIT
Climatic classification	According to IEC 68 part 1		55/100/21	
Comparative tracking index		CTI	175	
Tested withstanding isolation voltage	According to UL1577, t = 1 s	$V_{ISO}$	4000	$V_{RMS}$
Maximum transient isolation voltage	According to DIN EN 60747-5-5	$V_{IOTM}$	6000	$V_{peak}$
Maximum repetitive peak isolation voltage	According to DIN EN 60747-5-5	$V_{IORM}$	560	$V_{peak}$
Isolation resistance	$T_{amb} = 25\text{ }^{\circ}\text{C}$ , $V_{IO} = 500\text{ V}$	$R_{IO}$	$\geq 10^{12}$	$\Omega$
	$T_{amb} = 100\text{ }^{\circ}\text{C}$ , $V_{IO} = 500\text{ V}$	$R_{IO}$	$\geq 10^{11}$	$\Omega$
Output safety power		$P_{SO}$	350	mW
Input safety current		$I_{SI}$	150	mA
Input safety temperature		$T_S$	165	$^{\circ}\text{C}$
Creepage distance	DIP-6, option 6		4	mm
Clearance distance	DIP-6, option 6		4	mm
Insulation thickness			0.2	mm

**Note**

- As per IEC 60747-5-5, § 7.4.3.8.2, this optocoupler is suitable for “safe electrical insulation” only within the safety ratings. Compliance with the safety ratings shall be ensured by means of protective circuits.

**TYPICAL CHARACTERISTICS** ( $T_{amb} = 25\text{ }^{\circ}\text{C}$ , unless otherwise specified)

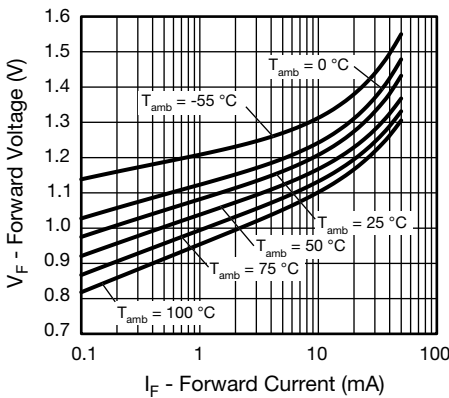

Fig. 4 - Forward Voltage vs. Forward Current

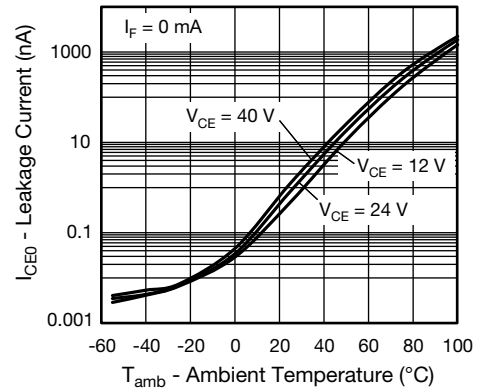

Fig. 6 - Leakage Current vs. Ambient Temperature

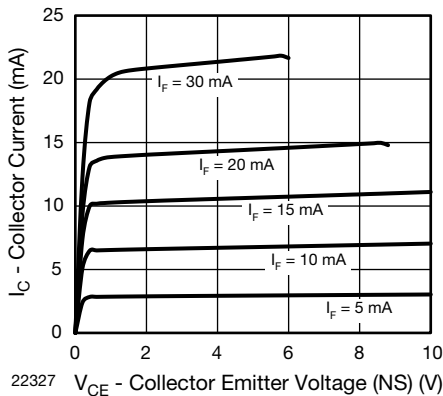

Fig. 5 - Collector Current vs. Collector Emitter Voltage (non-saturated)

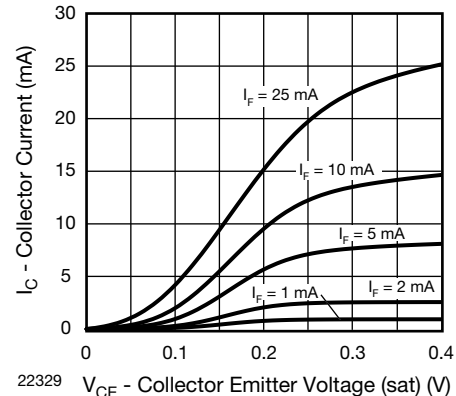

Fig. 7 - Collector Current vs. Collector Emitter Voltage (saturated)

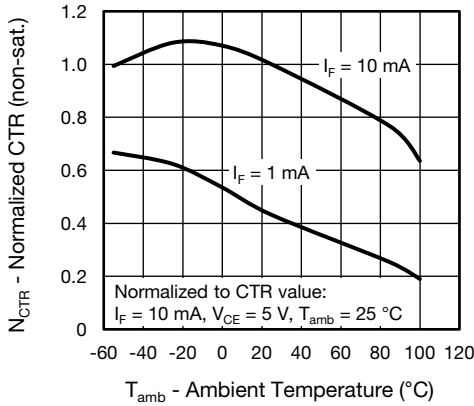

Fig. 8 - Normalized CTR (saturated) vs. Ambient Temperature

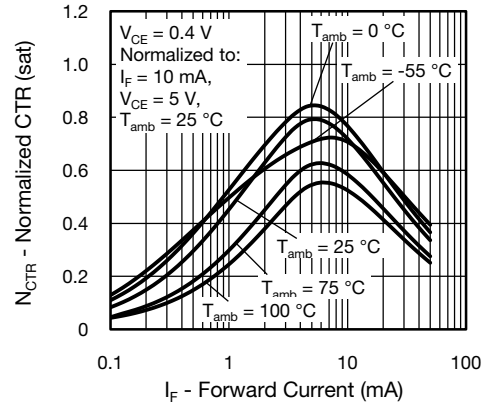

Fig. 11 - Normalized CTR (saturated) vs. Forward Current



Fig. 9 - Normalized CTR (non-saturated) vs. Ambient Temperature

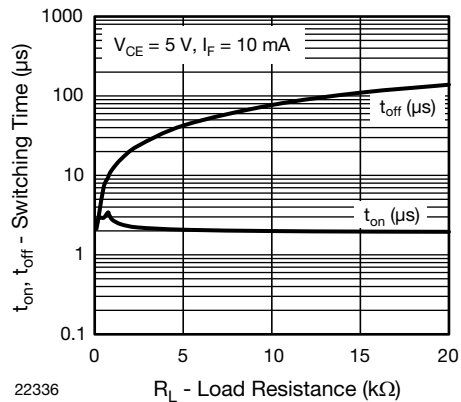

Fig. 12 - Switching Time vs. Load Resistance

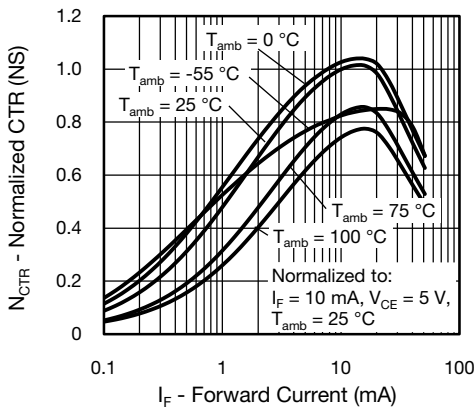

Fig. 10 - Normalized CTR (non-saturated) vs. Forward Current



Fig. 13 - Power Dissipation vs. Ambient Temperature



## PACKAGE DIMENSIONS (in millimeters)

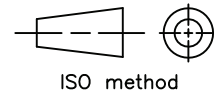

## PACKAGE MARKING (example)



### Note

- Tape and reel suffix (T) is not part of the package marking.

**TAPE AND REEL PACKAGING FOR DUAL CHANNELS <sup>(1)</sup>** (in millimeters)

Selected dual SOIC8 optocouplers are available in tape and reel format. To order surface mount ILD2XX optocoupler on tape and reel, add a suffix “T” after the part number, i.e., ILD207T.

The tape is 16 mm and is wound on a 33 cm reel. There are 2000 parts per reel. Taped and reeled dual SOIC8 optocouplers conform to EIA-481-2 and IEC 60286-3.

**Note**

<sup>(1)</sup> Select dual channel devices are available in the shorter SOIC-8 package and will be taped according to the single channel taping specification

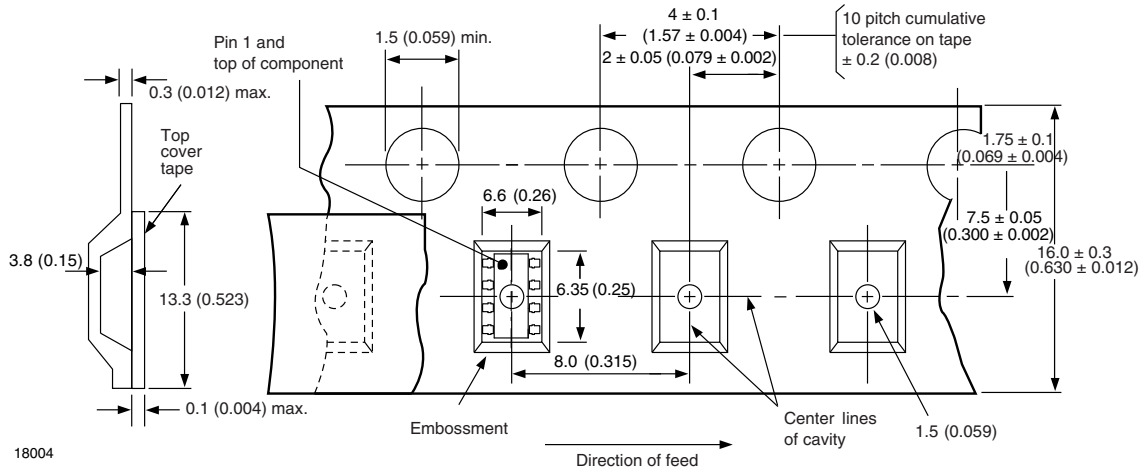

Fig. 14

**SOLDER PROFILE**

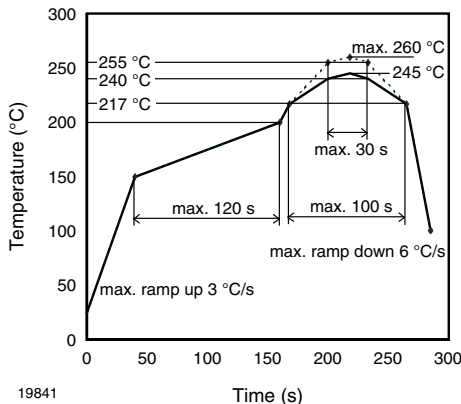

Fig. 15 - Lead (Pb)-free Reflow Solder Profile according to J-STD-020

**HANDLING AND STORAGE CONDITIONS**

ESD level: HBM class 2  
 Floor life: unlimited  
 Conditions: T<sub>amb</sub> < 30 °C, RH < 85 %  
 Moisture sensitivity level 1, according to J-STD-020



## Disclaimer

ALL PRODUCT, PRODUCT SPECIFICATIONS AND DATA ARE SUBJECT TO CHANGE WITHOUT NOTICE TO IMPROVE RELIABILITY, FUNCTION OR DESIGN OR OTHERWISE.

Vishay Intertechnology, Inc., its affiliates, agents, and employees, and all persons acting on its or their behalf (collectively, "Vishay"), disclaim any and all liability for any errors, inaccuracies or incompleteness contained in any datasheet or in any other disclosure relating to any product.

Vishay makes no warranty, representation or guarantee regarding the suitability of the products for any particular purpose or the continuing production of any product. To the maximum extent permitted by applicable law, Vishay disclaims (i) any and all liability arising out of the application or use of any product, (ii) any and all liability, including without limitation special, consequential or incidental damages, and (iii) any and all implied warranties, including warranties of fitness for particular purpose, non-infringement and merchantability.

Statements regarding the suitability of products for certain types of applications are based on Vishay's knowledge of typical requirements that are often placed on Vishay products in generic applications. Such statements are not binding statements about the suitability of products for a particular application. It is the customer's responsibility to validate that a particular product with the properties described in the product specification is suitable for use in a particular application. Parameters provided in datasheets and / or specifications may vary in different applications and performance may vary over time. All operating parameters, including typical parameters, must be validated for each customer application by the customer's technical experts. Product specifications do not expand or otherwise modify Vishay's terms and conditions of purchase, including but not limited to the warranty expressed therein.

Except as expressly indicated in writing, Vishay products are not designed for use in medical, life-saving, or life-sustaining applications or for any other application in which the failure of the Vishay product could result in personal injury or death. Customers using or selling Vishay products not expressly indicated for use in such applications do so at their own risk. Please contact authorized Vishay personnel to obtain written terms and conditions regarding products designed for such applications.

No license, express or implied, by estoppel or otherwise, to any intellectual property rights is granted by this document or by any conduct of Vishay. Product names and markings noted herein may be trademarks of their respective owners.