

TOLERANCE UNLESS OTHERWISE SPECIFIED IN MM:
 0 ±0.38 ANGLE °
 0.0 ±0.25
 0.00 ±0.10

THIS IS A C.A.D. GENERATED DRAWING
 DO NOT MAKE MANUAL REVISIONS TO MASTER.

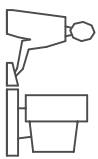

ISSUE NUMBER
 ORIGINAL
 1

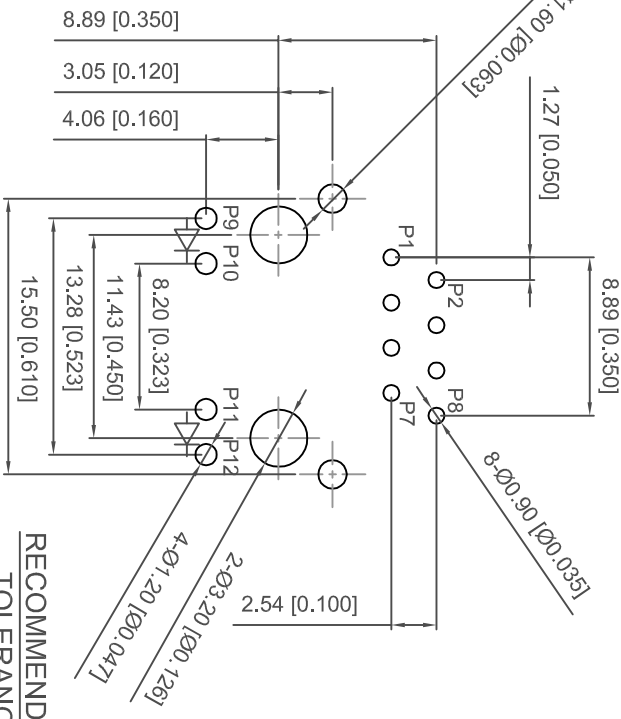
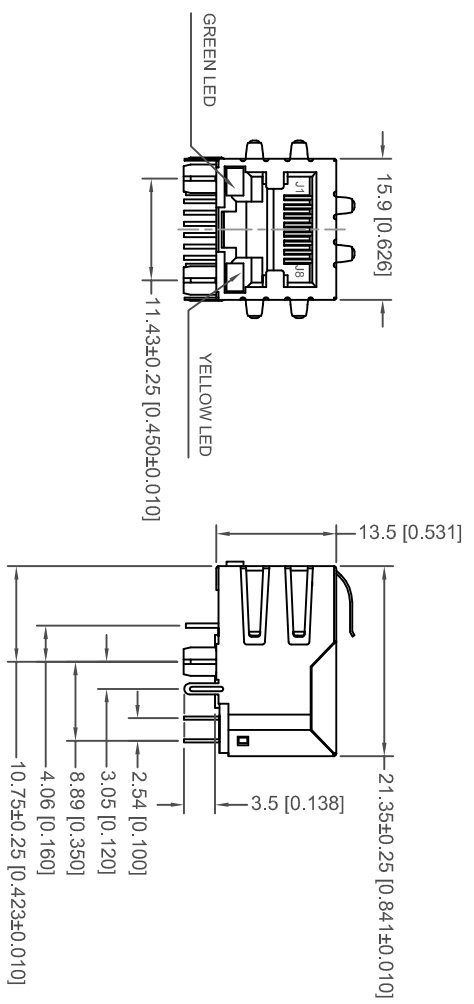

RECOMMENDED P.C.B. LAYOUT
 TOLERANCE: ±0.08[±0.003]

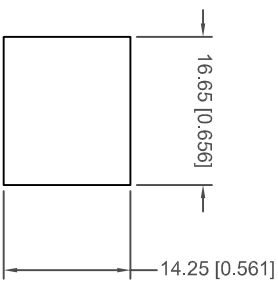
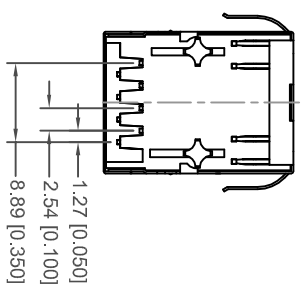

RECOMMENDED
 PANEL CUTOUT DIMENSION

NOTES:
 1. MATERIALS:
 HOUSING: THERMOPLASTIC, UL 94V-0, COLOR: BLACK
 SHIELD: COPPER ALLOY WITH NICKEL PLATING
 CONTACTS: COPPER ALLOY PLATED WITH GOLD PLATING AND TIN IN SOLDER AREA

PART NO	GOLD PLATING THICKNESS
A63-112-331P422	GOLD FLASH PLATING
A63-113-331P422	15 MICRO INCHES OF GOLD
A63-114-331P422	30 MICRO INCHES OF GOLD
A63-115-331P422	50 MICRO INCHES OF GOLD

- OPERATING TEMPERATURE: 0°C TO +70°C
- STORAGE TEMPERATURE: -40°C TO +85°C
- MATE WITH MODULAR PLUG CONFORMING TO FCC PART 68, SUBPART F.
- RECOMMENDED TEMPERATURE FOR WAVE SOLDERING IS 260°C MAX, 10 SEC MAX
- DIMENSION: MM [INCHES]



THIS SERIES FULLY CONFORMS TO THE EUROPEAN UNION DIRECTIVES 2002/95/EC AND 2002/96/EC FOR ROHS COMPLIANCY.

**RJ45 MAGNETIC JACK WITH LED, 8P, 8C
 SHIELDED/10/100 Mbps FILTER**

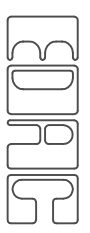

EDAC INC
 TORONTO, ONTARIO
 CANADA

YOUR CONNECTION TO QUALITY & SERVICE

THESE DRAWINGS AND SPECIFICATIONS ARE THE PROPERTY OF EDAC INC. AND SHALL NOT BE REPRODUCED OR COPIED OR USED AS THE BASIS FOR THE MANUFACTURE OR SALE OF APPARATUS WITHOUT WRITTEN PERMISSION.

ACAD REFERENCE NO.: A63-113-331P422

DRAWN: R.STA.MONICA DATE: OCT. 18/2011

CHECKED: DATE:

PART NUMBER SHEET 1 OF 2

SEE NOTE

DRAWING NUMBER ISSUE

A63-112-331P422 1

ELECTRICAL CIRCUIT:

TOLERANCE UNLESS OTHERWISE SPECIFIED IN MM:	ANGLE	X°
0	± 0.38	
0.0	± 0.25	
0.00	± 0.10	

THIS IS A C.A.D. GENERATED DRAWING
DO NOT MAKE MANUAL REVISIONS TO MASTER.

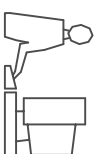

CONNECTOR SOLDER SIDE

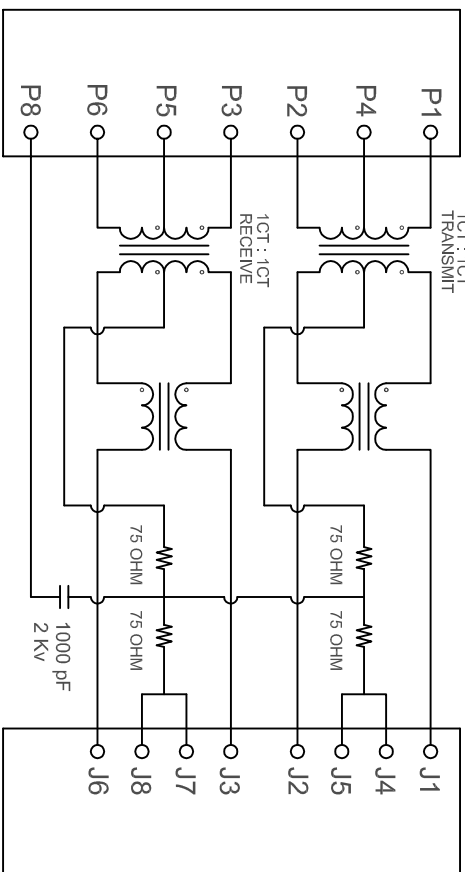

RJ45 CONTACT SIDE

LED CIRCUIT:

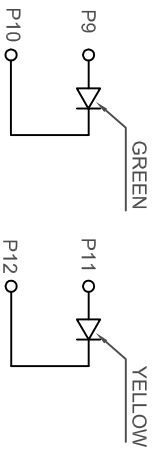

LED SPECIFICATIONS (WITH FORWARD CURRENT OF 20 mA)			
STANDARD LED	WAVELENGTH	FORWARD V (MAX)	TYP
GREEN	565 nm	2.4 V	2.2 V
YELLOW	590 nm	2.5 V	2.1 V

- TEST NOTES:(25±5°C)
- 1.TR:(100KHz,0.1V);
PINS:(P1-P2):(J1-J2)=1:1±3%
PINS:(P3-P6):(J3-J6)=1:1±3%
 - 2.LX:(100KHz,100mV,8mA, DC Bias)
PINS: (P1,P2),(P3,P6)=350uH MINIMUM
 - 3.DC RESISTANCE:
PINS:(J1-J2),(J3-J6)= 1.2 OHMS MAXIMUM
 - 4.HPOT:
PINS(P1,P2)TO(J1,J2)=1500VAC OR 2250VDC
PINS(P3,P6)TO(J3,J6)=1500VAC OR 2250VDC
 - 5.INSERTION LOSS:
-1.2dB MAXIMUM AT 100KHz TO 100MHz;
 - 6.RETURN LOSS:
-18dB MINIMUM AT 1MHz TO 30MHz;
-(18-20log(f/30))dB MINIMUM AT 30MHz TO 60MHz
-12dB MINIMUM AT 60MHz TO 80MHz
 - 7.CROSS TALK:
-35dB TYPICAL AT 1MHz TO 100MHz
 - 8.COMMON TO COMMON MODE ATTENUATION:
-30dB TYPICAL AT 30MHz TO 100MHz
 9. LEAKAGE INDUCTANCE:
PINS: P1-P2, WITH J1-J2 SHORTED=0.35 uH MAX @1MHz
PINS: P3-P6, WITH J3-J6 SHORTED=0.35 uH MAX @1MHz
 10. INTERWINDING CAPACITANCE:
PINS:(P1-P2):(J1-J2)= 35 pF MAX @1MHz
PINS:(P3-P6):(J3-J6)= 35 pF MAX @1MHz

RJ45 MAGNETIC JACK WITH LED, 8P, 8C
SHIELDED/10/100 Mbps FILTER



THIS SERIES FULLY CONFORMS TO THE
EUROPEAN UNION DIRECTIVES 2002/95/EC
AND 2002/96/EC FOR ROHS COMPLIANCY.



EDAC INC
TORONTO, ONTARIO
CANADA

YOUR CONNECTION TO QUALITY & SERVICE

THESE DRAWINGS AND SPECIFICATIONS
ARE THE PROPERTY OF EDAC INC. AND
SHALL NOT BE REPRODUCED OR COPIED
OR USED AS THE BASIS FOR THE
MANUFACTURE OR SALE OF APPARATUS
WITHOUT WRITTEN PERMISSION.

ACAD REFERENCE NO.: A63-113-331P422

DRAWN: R.STA.MONICA DATE: OCT. 18/2011

CHECKED: DATE:

PART NUMBER

SEE NOTE

SHEET 2 OF 2

DRAWING NUMBER

A63-112-331P422

ISSUE

1

Mouser Electronics

Authorized Distributor

Click to View Pricing, Inventory, Delivery & Lifecycle Information:

[EDAC:](#)

[A63-112-331P422](#)