

# Analog Devices Welcomes Hittite Microwave Corporation

NO CONTENT ON THE ATTACHED DOCUMENT HAS CHANGED



# HMC514\* Product Page Quick Links

Last Content Update: 08/30/2016

---

## [Comparable Parts](#)

View a parametric search of comparable parts

## [Evaluation Kits](#)

- HMC514LP5 Evaluation Board

## [Documentation](#)

### **Data Sheet**

- HMC514 Data Sheet

## [Reference Materials](#)

### **Quality Documentation**

- Package/Assembly Qualification Test Report: 32L 5x5mm QFN Package (QTR: 10009 REV: 05)
- Package/Assembly Qualification Test Report: LP3, LP4, LP5 & LP5G (QTR: 2014-00145)
- Package/Assembly Qualification Test Report: Plastic Encapsulated QFN (QTR: 05006 REV: 02)
- Semiconductor Qualification Test Report: GaAs HBT-A (QTR: 2013-00228)

## [Design Resources](#)

- HMC514 Material Declaration
- PCN-PDN Information
- Quality And Reliability
- Symbols and Footprints

## [Discussions](#)

View all HMC514 EngineerZone Discussions

## [Sample and Buy](#)

Visit the product page to see pricing options

## [Technical Support](#)

Submit a technical question or find your regional support number

---

**THIS PAGE INTENTIONALLY LEFT BLANK**



## MMIC VCO w/ HALF FREQUENCY OUTPUT & DIVIDE-BY-4, 11.17 - 12.02 GHz

### Typical Applications

Low noise MMIC VCO w/Half Frequency, Divide-by-4 Outputs for:

- VSAT Radio
- Point to Point/Multipoint Radio
- Test Equipment & Industrial Controls
- Military End-Use

### Features

- Dual Output:  $F_o = 11.17 - 12.02$  GHz  
 $F_o/2 = 5.58 - 6.01$  GHz
- Pout: +7 dBm
- Phase Noise: -110 dBc/Hz @100 KHz Typ.
- No External Resonator Needed
- 32 Lead 5x5mm SMT Package: 25mm<sup>2</sup>

### Functional Diagram

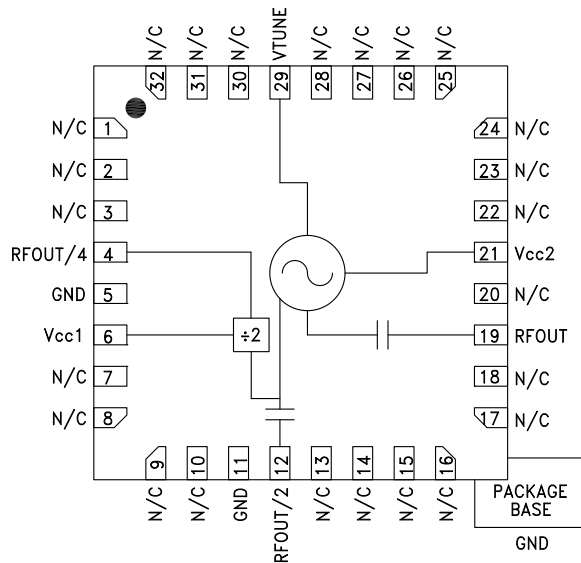

### General Description

The HMC514LP5 & HMC514LP5E are GaAs InGaP Heterojunction Bipolar Transistor (HBT) MMIC VCOs. The HMC514LP5 & HMC514LP5E integrate resonators, negative resistance devices, varactor diodes and feature half frequency and divide-by-4 outputs. The VCO's phase noise performance is excellent over temperature, shock, and process due to the oscillator's monolithic structure. Power output is +7 dBm typical from a +3V supply voltage. The prescaler function can be disabled to conserve current if not required. The voltage controlled oscillator is packaged in a leadless QFN 5x5 mm surface mount package, and requires no external matching components.

### Electrical Specifications, $T_A = +25^\circ C$ , $V_{cc1}, V_{cc2} = +3V$

Parameter	Min.	Typ.	Max.	Units	
Frequency Range	$F_o$ $F_o/2$	11.17 - 12.02 5.585 - 6.01		GHz GHz	
Power Output	RFOUT RFOUT/2 RFOUT/4	+5 +5 -10	+10 +11 -4	dBm dBm dBm	
SSB Phase Noise @ 100 kHz Offset, $V_{tune} = +5V$ @ RFOUT		-110		dBc/Hz	
Tune Voltage	$V_{tune}$	2	13	V	
Supply Current	$I_{cc1}$ & $I_{cc2}$	240	275	290	mA
Tune Port Leakage Current ( $V_{tune} = 13V$ )			10	$\mu A$	
Output Return Loss		2		dB	
Harmonics/Subharmonics	1/2 3/2 2nd 3rd		30 24 17 28	dBc dBc dBc dBc	
Pulling (into a 2.0:1 VSWR)		4		MHz pp	
Pushing @ $V_{tune} = 5V$		18		MHz/V	
Frequency Drift Rate		1.2		MHz/ $^\circ C$	

For price, delivery and to place orders: Hittite Microwave Corporation, 20 Alpha Road, Chelmsford, MA 01824  
 Phone: 978-250-3343 Fax: 978-250-3373 Order On-line at [www.hittite.com](http://www.hittite.com)  
 Application Support: Phone: 978-250-3343 or [apps@hittite.com](mailto:apps@hittite.com)



## MMIC VCO w/ HALF FREQUENCY OUTPUT & DIVIDE-BY-4, 11.17 - 12.02 GHz

**Frequency vs. Tuning Voltage, T= 25°C**

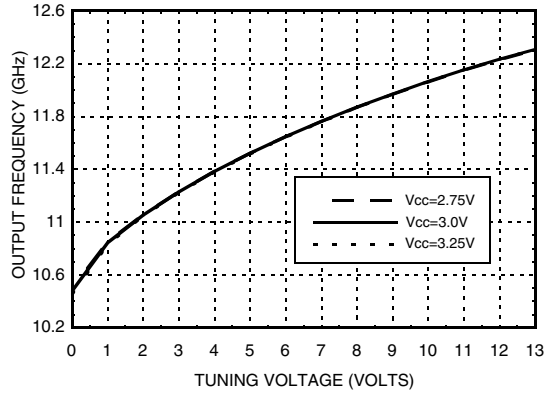

**Frequency vs. Tuning Voltage, Vcc= +3V**

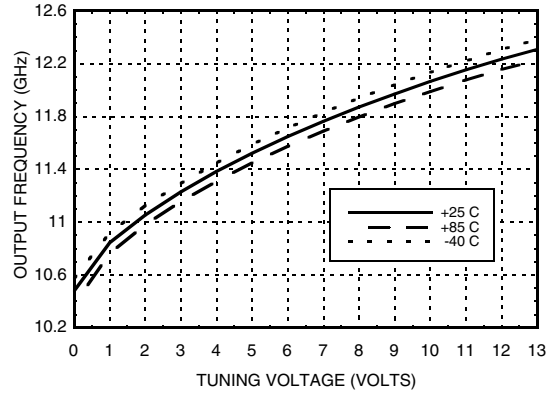

**Sensitivity vs. Tuning Voltage, Vcc= +3V**

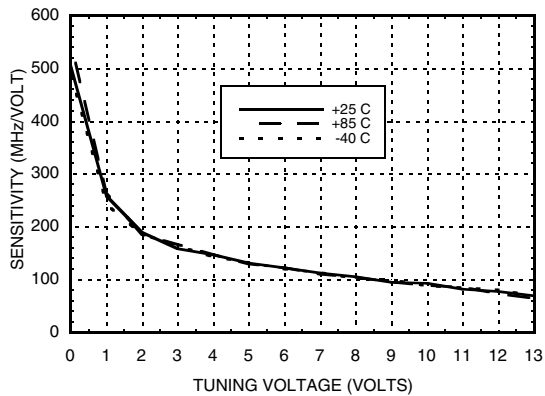

**Output Power vs. Tuning Voltage, Vcc= +3V**

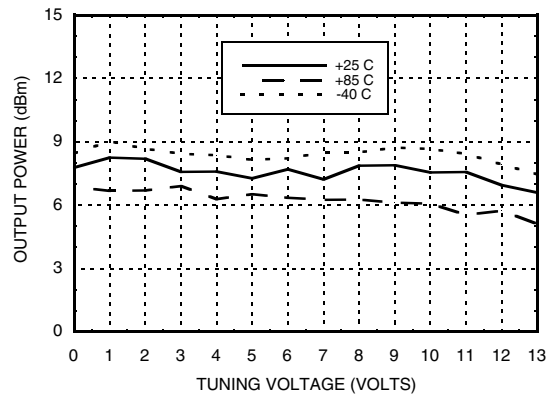

**SSB Phase Noise vs. Tuning Voltage**

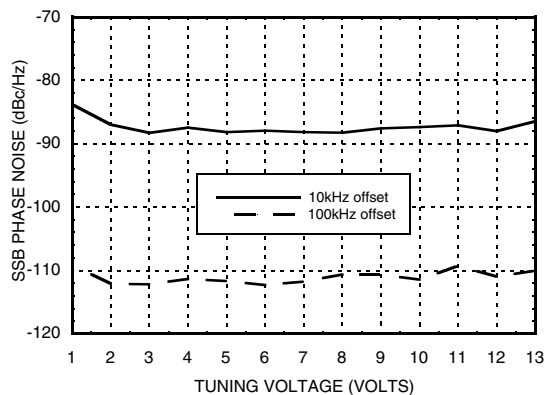

**SSB Phase Noise @ Vtune= +5V**

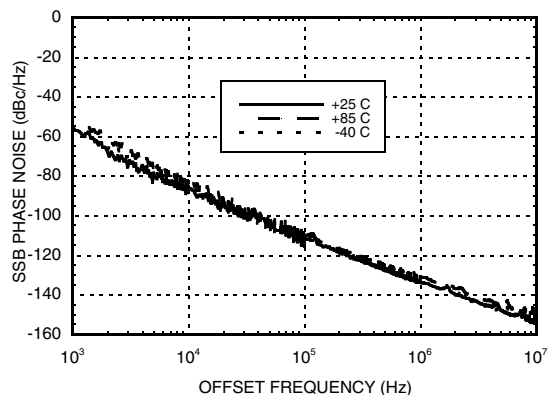



## MMIC VCO w/ HALF FREQUENCY OUTPUT & DIVIDE-BY-4, 11.17 - 12.02 GHz

**RFOUT/2 Frequency vs. Tuning Voltage, Vcc= +3V**

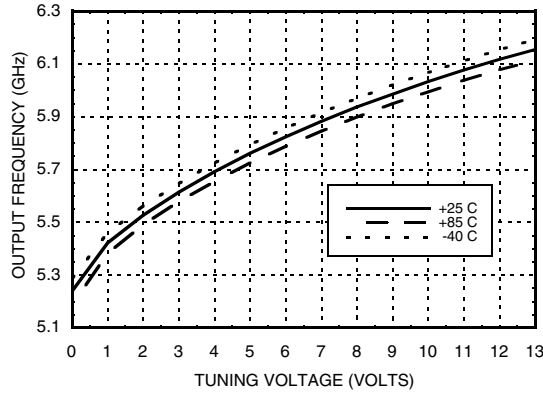

**RFOUT/2 Output Power vs. Tuning Voltage, Vcc= +3V**

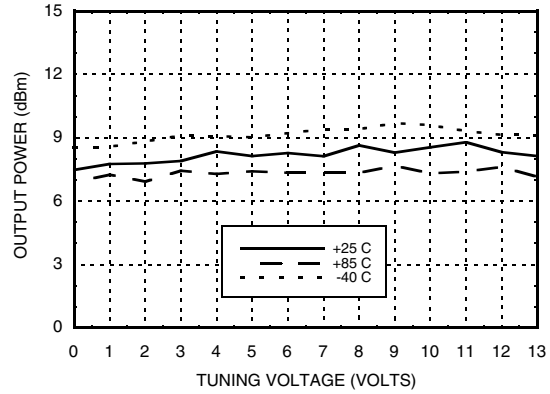

**Divide-by-4 Frequency vs. Tuning Voltage, Vcc= +3V**

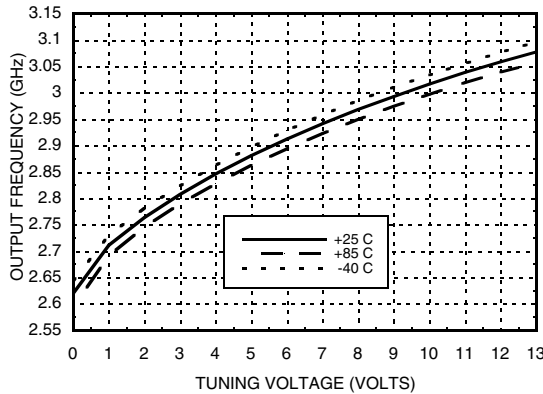

**Divide-by-4 Output Power vs. Tuning Voltage, Vcc= +3V**

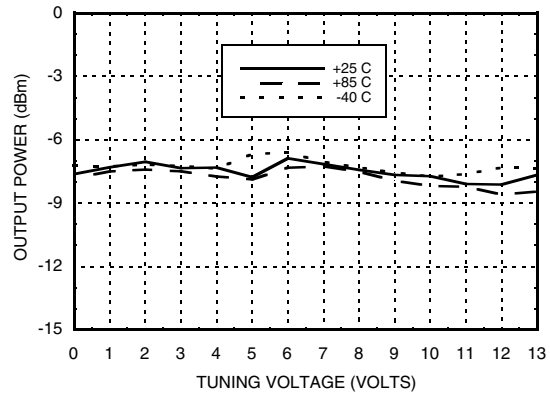

### Absolute Maximum Ratings

Vcc1, Vcc2	+3.5 Vdc
Vtune	0 to +15V
Junction Temperature	135 °C
Continuous Pdiss (T=85 °C) (derate 27 mW/C above 85 °C)	1.3 W
Thermal Resistance (junction to ground paddle)	37.5 °C/W
Storage Temperature	-65 to +150 °C
Operating Temperature	-40 to +85 °C

### Typical Supply Current vs. Vcc

Vcc (V)	Icc (mA)
2.75	230
3.0	275
3.25	320

Note: VCO will operate over full voltage range shown above.



**ELECTROSTATIC SENSITIVE DEVICE  
OBSERVE HANDLING PRECAUTIONS**



**MMIC VCO w/ HALF FREQUENCY OUTPUT  
& DIVIDE-BY-4, 11.17 - 12.02 GHz**

**Outline Drawing**

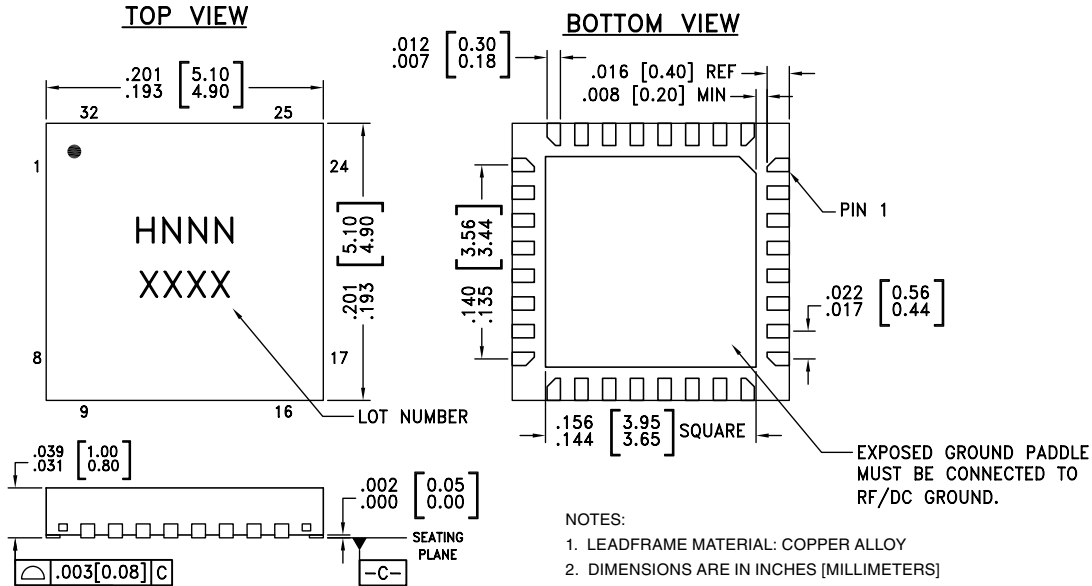

**NOTES:**

1. LEADFRAME MATERIAL: COPPER ALLOY
2. DIMENSIONS ARE IN INCHES [MILLIMETERS]
3. LEAD SPACING TOLERANCE IS NON-CUMULATIVE.
4. PAD BURR LENGTH SHALL BE 0.15mm MAXIMUM.  
PAD BURR HEIGHT SHALL BE 0.05mm MAXIMUM.
5. PACKAGE WARP SHALL NOT EXCEED 0.05mm.
6. ALL GROUND LEADS AND GROUND PADDLE MUST BE SOLDERED TO PCB RF GROUND.
7. REFER TO HITTITE APPLICATION NOTE FOR SUGGESTED LAND PATTERN.

**Package Information**

Part Number	Package Body Material	Lead Finish	MSL Rating	Package Marking <sup>[3]</sup>
HMC514LP5	Low Stress Injection Molded Plastic	Sn/Pb Solder	MSL3 <sup>[1]</sup>	H514 XXXX
HMC514LP5E	RoHS-compliant Low Stress Injection Molded Plastic	100% matte Sn	MSL3 <sup>[2]</sup>	H514 XXXX

[1] Max peak reflow temperature of 235 °C  
 [2] Max peak reflow temperature of 260 °C  
 [3] 4-Digit lot number XXXX

**Pin Descriptions**

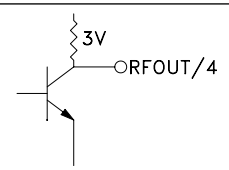
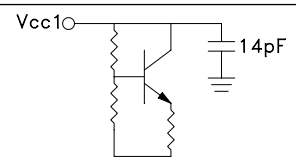
Pin Number	Function	Description	Interface Schematic
1 - 3, 7 - 10, 13 - 18, 20, 22 - 28, 30 - 32	N/C	No Connection. These pins may be connected to RF/DC ground. Performance will not be affected.	
4	RFOUT/4	Divide-by-4 Output.	
6	VCC1	Supply Voltage for prescaler. If prescaler is not required, this pin may be left open to conserve 40 mA of current.	



**MMIC VCO w/ HALF FREQUENCY OUTPUT  
& DIVIDE-BY-4, 11.17 - 12.02 GHz**

**Pin Descriptions**

Pin Number	Function	Description	Interface Schematic
12	RFOUT/2	Half frequency output (AC coupled).	
19	RF OUT	RF output (AC coupled).	
21	VCC2	Supply Voltage, +3V	
29	VTUNE	Control Voltage Input. Modulation port bandwidth dependent on drive source impedance.	
5, 11, Paddle	GND	Package bottom has an exposed metal paddle that must be connected to RF/DC ground.	

**Typical Application Circuit**

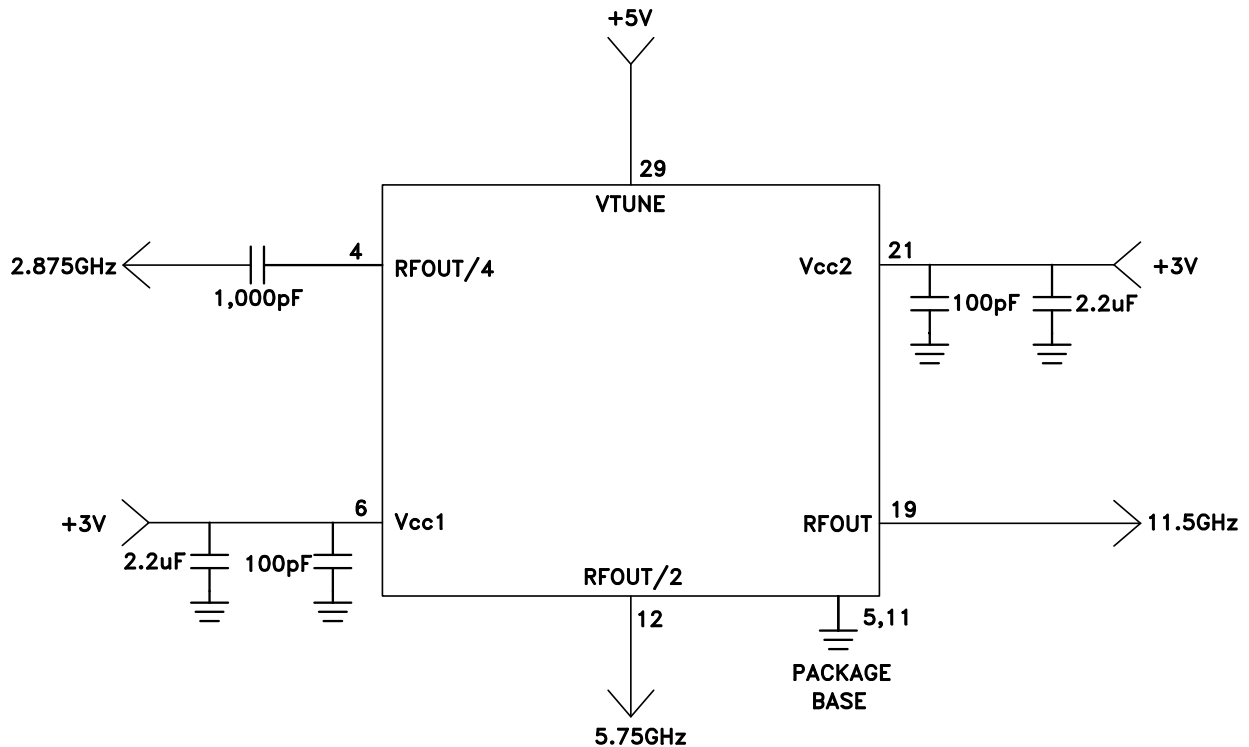



### Evaluation PCB

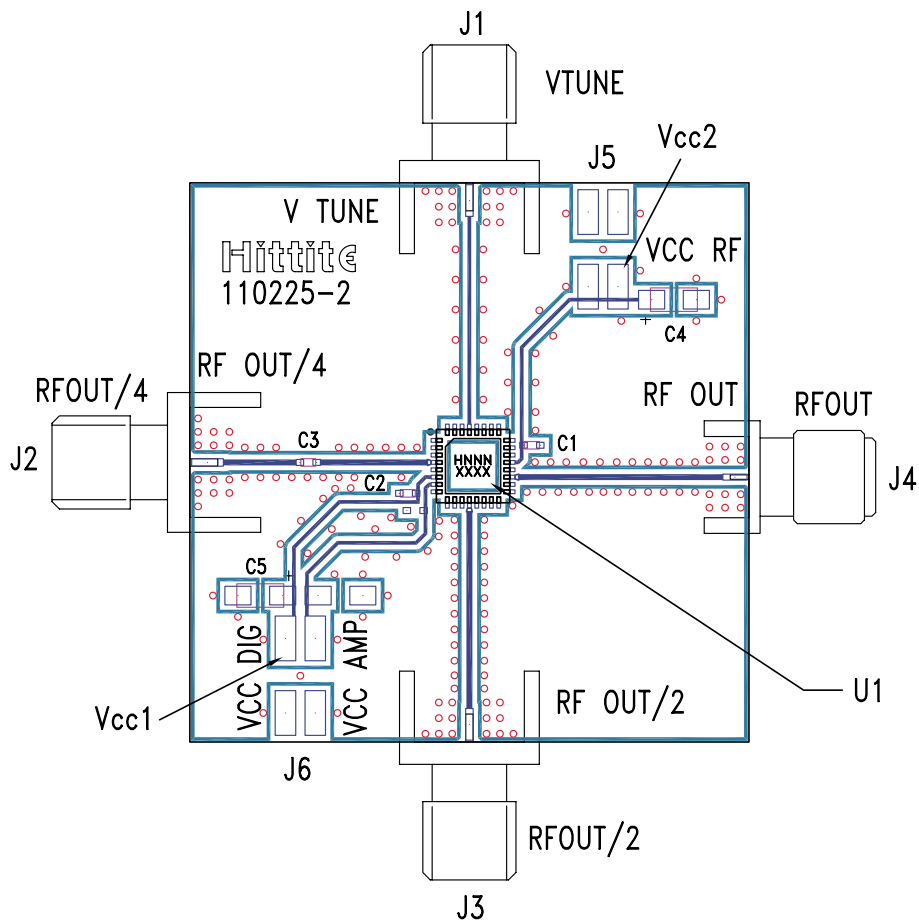

### List of Materials for Evaluation PCB 110227 [1]

Item	Description
J1 - J4	PCB Mount SMA RF Connector
J5 - J6	2 mm DC Header
C1 - C2	100 pF Capacitor, 0402 Pkg.
C3	1,000 pF Capacitor, 0402 Pkg.
C4 - C5	2.2 $\mu$ F Tantalum Capacitor
U1	HMC514LP5 / HMC514LP5E VCO
PCB [2]	110225 Eval Board

[1] Reference this number when ordering complete evaluation PCB

[2] Circuit Board Material: Rogers 4350

The circuit board used in the application should use RF circuit design techniques. Signal lines should have 50 Ohm impedance while the package ground leads and backside ground paddle should be connected directly to the ground plane similar to that shown. A sufficient number of via holes should be used to connect the top and bottom ground planes. The evaluation circuit board shown is available from Hittite upon request.