



深圳东裕光大电子有限公司  
广州市东裕光电科技有限公司

## 样品承认书

### Sample Approve Sheet

客户名称 (Customer name) : \_\_\_\_\_

组件名称 (Production name) : \_\_\_\_\_

型 号 (Model) :         DY-0603SRC-L-SMG        

编 号 (Part number) : \_\_\_\_\_

日 期 (Date) :         2020.2.11        

客户确认 CUSTOMER CONFIRMATION	审 核 CHECKED BY	编 制 PREPARED BY
	汪建新	陈少龙

地址(Add): 广东省东莞市长安镇长青南路 1 号长安万科广场 8 栋 4903

厂址(Add): 广东省广州市番禺区石基镇海涌路 3 号 10 号厂房 2 楼

电话(Tel): 0755-88367730 020-39294688

传真(Fax): 020-39966833

网址(Net): [www.tonyuled.cn](http://www.tonyuled.cn) [www.tonyuled.com](http://www.tonyuled.com)

### Features( 特征)

- Extremely wide viewing angle. ( 宽的发光角度)
- Suitable for all SMT assembly and solder process. ( 适用于所有的SMT组装和焊接工艺)
- Available on tape and reel. ( 适用于载带及卷轴)
- Moisture sensitivity level: Level 4. ( 防潮等级 Level 4)
- Package:4000pcs/reel..(包装每卷4000PCS)
- RoHS compliant. (RoHS 认证)

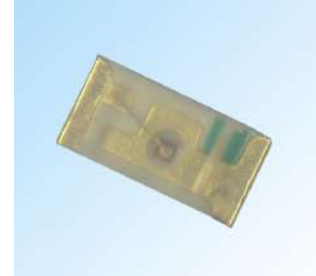

### Description ( 描述)

The Red source color devices are made with AlGaInP on Substrate Light Emitting Diode

红光LED由AlGaInP四种元素芯片激发而成



**ATTENTION**  
OBSERVE PRECAUTIONS  
FOR HANDLING  
ELECTROSTATIC  
DISCHARGE  
SENSITIVE  
DEVICES

注意：操作时应注意静电敏感  
释放设备装置

### Applications ( 应用)

- Optical indicator ( 光学指示)
- Backlight for LCD, switch and Symbol, display  
(LCD背光、转换器，开关和标志，显示器等)
- General use ( 一般应用)

### Package Dimensions ( 封装尺寸)

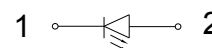
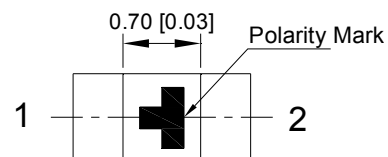
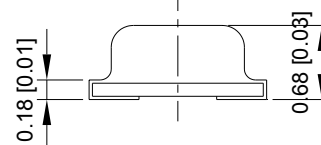
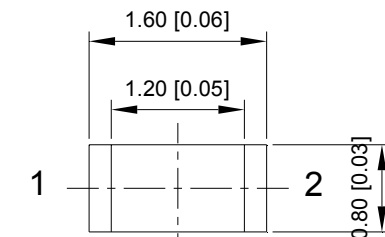

### Recommended Soldering Pattern

( 建议焊盘尺寸图)

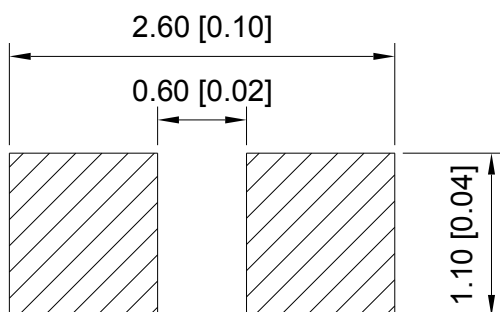

Notes: ( 备注)

1. Mark the size of the unit is mm.marked in brackets ( 标注尺寸单位为毫米,括号内标注为英寸)
2. All dimensions allow tolerance  $\pm 0.1\text{mm}$  ( 所有尺寸允许公差 $\pm 0.1\text{mm}$  )

### Selection Guide (选择指南)

Part No. 型号	Dice	Lens Type 胶体类型	Luminous intensity(mcd) 光强@ 10mA		Angle 角度
			Min	Typ	2θ1/2
DY-0603SRC-L	Red(AlGaInP)	Water Clear	--	120	130°

Note:(备注)

1. The 2θ1/2 measurement error  $\pm 10$  degrees( 角度测试误差为 $\pm 10^\circ$  )
2. the above luminous intensity measurement allowance tolerance  $\pm 10\%$ .  
上述发光强度的测试允许公差为 $\pm 10\%$

### Electrical / Optical Characteristics at Ta=25°C 电性与光学特性

Parameter (参数)	Symbol (符号)	Min. (最小)	Typ. (平均)	Max. (最大)	Units (单位)	Test Conditions 测试条件
Forward Voltage 正向电压	V <sub>F</sub>	1.7	--	2.5	V	I <sub>F</sub> =10mA
Dominant Wavelength 主波长	λ <sub>d</sub>	--	620	--	nm	I <sub>F</sub> =10mA
Reverse Current 反向电流	I <sub>R</sub>	--	--	10	μA	V <sub>R</sub> = 5V

### Absolute Maximum Ratings at Ta=25°C 绝对最大额定值

Parameter (参数)	Symbol (符号)	Rating (值)	Units (单位)
Power Dissipation (功耗)	P <sub>d</sub>	50	mW
Forward Current (正向电流)	I <sub>F</sub>	20	mA
Peak Forward Current [1] (峰值正向电流)	I <sub>FP</sub>	30	mA
Reverse Voltage (反向电压)	V <sub>R</sub>	5	V
Electrostatic Discharge (HBM) (静电)	ESD	1000	V
Operating Temperature (操作温度)	T <sub>opr</sub>	-40 ~ +85	°C
Storage Temperature (保存温度)	T <sub>stg</sub>	-40 ~ +100	°C

Note: (备注)

1. 1/10 Duty cycle, 0.1ms pulse width. (脉宽0.1ms, 周期1/10)
2. The above forward voltage measurement allowance tolerance is  $\pm 0.1V$ . (以上所示电压测量误差 $\pm 0.1V$ )

### Typical optical characteristics curves 典型光学特性曲线

Ambient Temperature VS Allowable Forward Current 周围温度与允许电流特性

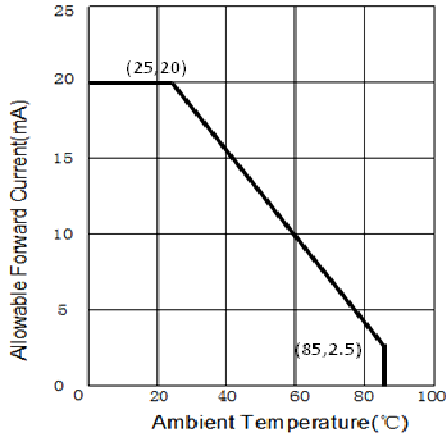

Forward Current VS. Relative Intensity 正向电流与相对光强特性曲线

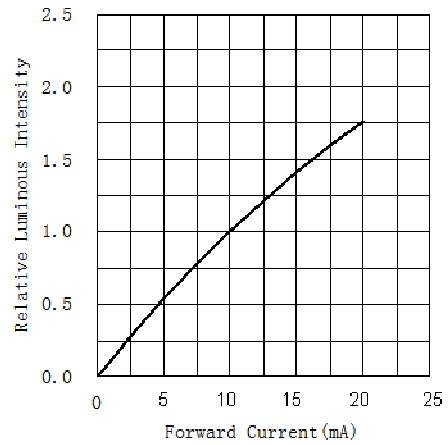

Forward Voltage VS. Forward Current 正向电压与正向电流特性曲线

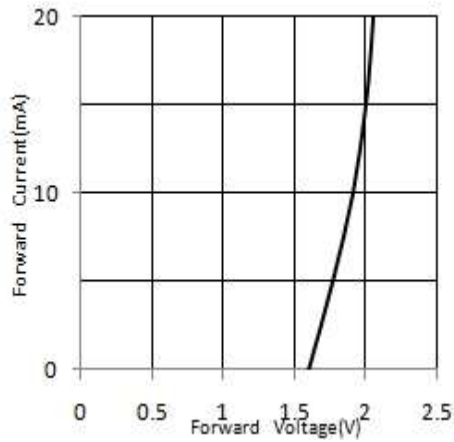

Ambient Temperature VS. Relative Intensity 环境温度与相对光强特性曲线

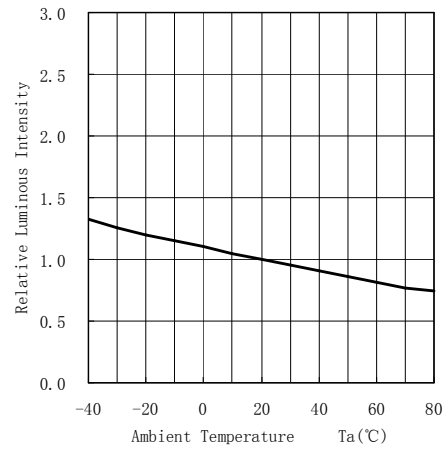

Relative spectral emission 相对光谱分布特性曲线

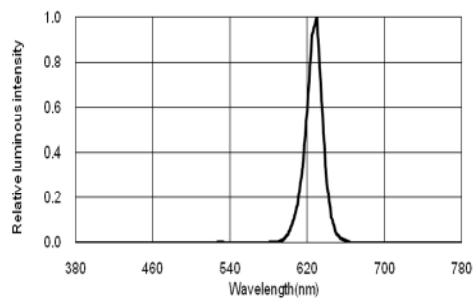

Radiation diagram 辐射图特性曲线

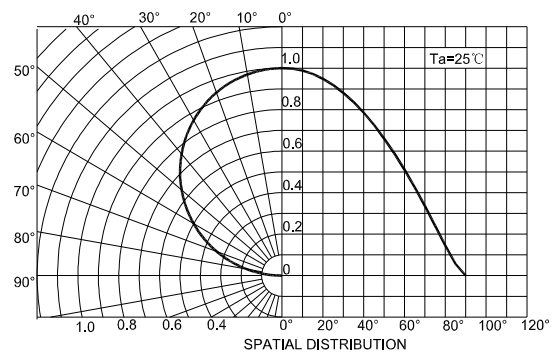

### Reliability Test Items And Conditions 信赖性测试项目及条件

Test Items 项目	Ref.Standard 参考标准	Test Condition 测试条件	Time 时间	Quantity 数量	Ac/Re 接收/拒收
Reflow 回流焊	JESD22-B106	Temp:260°C max T=10 sec	3 times.	22Pcs.	0/1
Temperature Cycle 温度循环	JESD22-A104	100°C±5°C 30 min. ↑↓5 min -40°C±5°C 30 min.	100 Cycles	22Pcs.	0/1
High Temperature Storage 高温保存	JESD22-A103	Temp:100°C±5°C	1000Hrs.	22Pcs.	0/1
Low Temperature Storage 低温保存	JESD22-A119	Temp:-40°C±5°C	1000Hrs.	22Pcs.	0/1
Life Test 常温通电	JESD22-A108	Ta=25°C±5°C IF=10mA	1000Hrs.	22Pcs.	0/1
High Temperature High Humidity 高温高湿保存	JESD22-A101	85°C±5°C/ 85%RH	1000Hrs.	22Pcs.	0/1

### Criteria For Judging Damage 失效判定标准

Test Items 项目	Symbol 符号	Test Condition 测试条件	Criteria For Judgement 判定标准	
			Min. 最小	Max. 最大
Forward Voltage 正向电压	VF	IF=10mA	--	U.S.L*)x1.1
Luminous Flux 光通量	lm	IF=10mA	L.S.L*)x0.7	--

U.S.L: Upper standard level 规格上限

L.S.L: Lower standard level 规格下限

\*The technical information shown in the data sheets are limited to the typical characteristics and circuit examples of the referenced products. It does not constitute the warranting of industrial property nor the granting of any license.

数据工作表中所示的技术信息仅限于典型特征和电路实例引用的产品。它既不构成工业特性的保证，也不构成任何许可的授权

### SMT Reflow Soldering Instructions SMT回流焊说明

1.Reflow soldering should not be done more than two times. 回流焊不可以做两次以上

2.When soldering , do not put stress on the LEDs during heating

当焊接时，不要在材料受热时用力压胶体表面

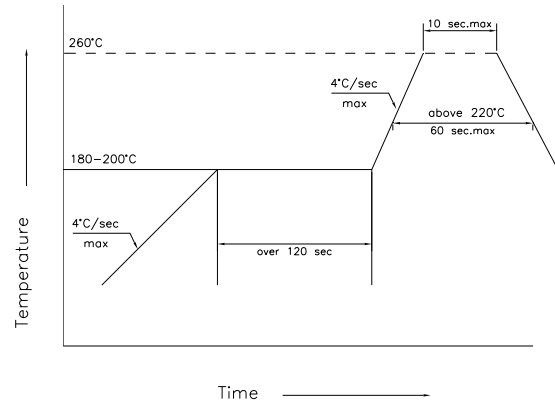

### Soldering iron 烙铁焊接

1.When hand soldering, keep the temperature of iron below less 300°C less than 3 seconds

当手工焊接时，烙铁的温度必须小于300°C，时间不可超过3秒

2.The hand solder should be done only one times

手工焊接只可焊接一次

### Repairing 修补

Repair should not be done after the LEDs have been soldered. When repairing is unavoidable, a double-head soldering iron should be used (as below figure). It should be confirmed in advance whether the characteristics of LEDs will or will not be damaged by repairing.

LED回流焊后不应该修复，当修复是不可避免时，必须使用双头烙铁（如下图），但必须事先确认此种方式会不会损坏LED本身的特性。

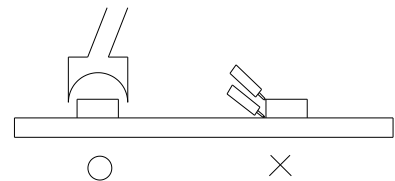

### Cautions 注意事项

The encapsulated material of the LEDs is silicone. Therefore the LEDs have a soft surface on the top of package. The pressure to the top surface will be influence to the reliability of the LEDs. Precautions should be taken to avoid the strong pressure on the encapsulated part. So when use the picking up nozzle, the pressure on the silicone resin should be proper.

LED封装为硅胶，故LED胶体表面较软，用力按压胶体表面会影响LED可靠性，因此应有预防措施避免在封装的零件上的强大压力，当使用吸嘴时，胶体表面的压力应是恰当的。

3.Do not stack together assembled PCBs containing LEDs. Impact may scratch the silicone lens or damage the internal circuitry

不可将模组材料堆积在一起，它可能会损坏内部电路

4.Not suitable to operate in acidic environment, PH<7

不可用在PH<7的酸性场所

